

Product Bulletin

Brand/product: Steelcraft

Date: June 26, 2023

Subject: June 2023 Price Book Updates

General Information and various

Many: General formatting and error corrections

SL and A14 Series Doors

Page 46: Correct pricing for SL door

Page 54: Correct A-60 price for A14 door

H-Series Hurricane Doors

Page 56: Added FBC EHPA combined Hurricane/Tornado label guiding to order through PW Series

Page 56: TDI now supported by third-party evaluation reports allowing use of FBC listings and labels

PW and FP Paladin-Series Tornado Resistant Doors and Frames

Page 58, 60: Added FBC EHPA combined Hurricane/Tornado label.

Page 59: Clarity on continuous hinge availability

INPACT Integrated Door System

Page 60: Added pricing for astragal or wide inactive leaf; clarified Temp Rise core under Core materials

Page 61: Clarity on continuous hinge availability

Page 62: Added Astragal (double egress) or Wide Inactive (same swing pair). Page number correction for Special size and glack thicknesses. Changed Temperature Rise Core (T Series) to Standard

Page 63-64: Clarified price for std full width closer reinforcement and continuous hinge reinforcement

Parts and Hardware Preps

Page 73: Double Lip strike clarification to use with pivot set on page 76 if combo release

Page 113: Price correction Dutch door shelves

Page 118: Discontinued Frame back coating/asphaltic coating in spray can version only

West Coast Service Center

Page 132: Remove WH description for 8'0" tall doors; added note to order through Door Mods for fire label

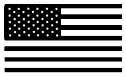

STEELCRAFT®

Price book 10

Effective February 25, 2023 • Rev. 06/23



This price list supersedes and cancels all previous price lists. Prices shown are subject to change without notice.

Administrative Offices

Allegion Administrative Office
11819 N. Pennsylvania St.
Carmel, IN 46032
allegion.com/us

Placing orders

You can place orders with Allegion via the fax number or email listed below:

Blue Ash Purchase Orders
Fax#: 1-800-356-7178
Email: Steelcraft_Order_Entry@allegion.com

West Coast Service Center Purchase Orders
Fax#: 1-888-485-4747
Email: SteelcraftOrderEntryChino@allegion.com

List Price Estimating

Blue Ash and West Coast Service Center
Email: Steelcraftestimating@allegion.com

Customer Care

Our Customer Care Representatives are available for questions or assistance.
You can reach them at **877-671-7011** (Press 1 for Sales Support | Press 2 for Product Support | Press 3 for RSO) or through the email addresses listed below:

Sales Support

support@allegion.com

Technical Product Support

Doors and Frames
Doors_Frames_TechProdSupport@allegion.com

Request for Quote

Carolinas

(North Carolina, South Carolina, Virginia)
Carolinas.Quotes@allegion.com

Central

(Illinois, Iowa, Kansas, Missouri, Nebraska)
Central.Quotes@allegion.com

Chicago

(Northern Illinois, Wisconsin)
Chicago.Quotes@allegion.com

Florida

Florida.Quotes@allegion.com

Metro New York

(Metro New York, Northern New Jersey)
Metro.Quotes@allegion.com

Michigan

Michigan.Quotes@allegion.com

Mid Atlantic North

(New York, Western Pennsylvania)
Mid.Atlantic.North.Quotes@allegion.com

Mid Atlantic South

(Delaware, Eastern Pennsylvania, Maryland, Northern Virginia, Southern New Jersey, Washington DC)
Mid.Atlantic.South.Quotes@allegion.com

Midwest

(Indiana, Kentucky, Ohio, West Virginia)
Midwest.Quotes@allegion.com

Mountain States

(Colorado, Idaho, Montana, Nevada, Utah, Wyoming)
Mtn.States.Quotes@allegion.com

New England

(Connecticut, Maine, Massachusetts, New Hampshire, Rhode Island, Vermont)
NewEngland.Quotes@allegion.com

North Central

(Minnesota, North Dakota, South Dakota)
NorthCentral.Quotes@allegion.com

Northern California

NoCal.Quotes@allegion.com

Northwest

(Alaska, Oregon, Washington)
Northwest.Quotes@allegion.com

South

(Alabama, Georgia, Louisiana, Mississippi, Tennessee)
South.Quotes@allegion.com

Southern California

(Southern California, Hawaii)
SoCal.Quotes@allegion.com

Southwest

(Arizona, New Mexico)
Southwest.Quotes@allegion.com

Texas

(Arkansas, Texas, Oklahoma)
Texas.Quotes@allegion.com

TABLE OF CONTENTS

GENERAL INFORMATION

Table of Contents3
 Ordering Information and Standards 4
 Programs - Blue Ash5
 Programs - West Coast Service Center.....5
 Programs - Rapid Frame Options.....5
 Programs - Rapid Door Options5

FRAMES

Frame Product Information 11
 Flush Frames12
 Drywall Frames 24
 Stainless Steel Frames..... 29
 Thermal Break Frames30
 Casing-Ready Frames..... 34

DOORS

Door Product Information..... 43
 Full Flush Doors.....44
 Embossed Panel Doors..... 52
 Full Glass Entrance Doors 54
 Storm Resistant Doors56
 Integrated Door System..... 62
 Glass Lights.....64
 Custom Door Options66
 Stainless Steel Doors.....68

HARDWARE PREPS

Coordinators 73
 Closers..... 73
 Flushbolts 73
 Rescue Hardware 73
 Hinges 74
 Holders and Stops 74
 Locks and Strikes 75
 Pivots..... 76
 Push/Pulls..... 76

STICKS

Lineal Inch Stick Pricing 78
 Stick Lengths (TSF Parts)..... 83
 Transom Frames Without Transom Bars.....90
 Borrowed Light Frames 93
 Laminated Transom Panels 97

PARTS

Frame Parts.....100
 Door Parts110

STOCK (BLUE ASH)

Frame Components..... 120
 Welded 3 Sided Frames122
 Stick Lengths123
 Frame Kwik-Paks 124
 Door (Units & Kwik Paks)125

WEST COAST SERVICE CENTER

Modified Stock.....127
 Frame Components..... 129
 Flush Doors131

Policies and documents
 The purchase of Allegion products is governed by the Allegion Authorized Seller Program. For program terms and conditions, and other program details, please visit: www.allegion.com/AuthorizedSeller.

 For Warranty information, visit us.allegion.com/warranty or contact Customer Service at 877-671-7011.

Prices subject to change without notice.

GENERAL INFORMATION:

1. A purchase order without complete information is **not considered an order**. Prior to sending your order, please make sure that you have all necessary information (templates if required, shipping destinations, and all other information pertinent to the order).
2. Please include all necessary information within the individual order line. While efforts will be made to question, conflicting information between a header page and an individual order line will default to the order line detail.
3. Shipping lead-time for weekly scheduled orders is calculated from the following week that final information is received.
4. Order cutoff is 12:00 midnight EST/EDT, and is based on the program and facility:
 - Blue Ash – Customer ship date for all programs
 - West Coast Service Center – Thursday for all programs
5. For improved accuracy and processing time, please place orders using US/Imperial units of measure.

EXCEPTIONS:

1. The cutoff dates will be adjusted for weeks with holidays. Refer to the Weekly Lead-Time Bulletin for any schedule adjustments.
2. Orders containing products with different shipping schedules will be scheduled per the longest lead-time product.
- **Steelcraft does not split orders based on lead-times.**
3. Orders requiring changes 48 hours after acknowledgment will be subject to cancellation charges and/or revised shipping schedules.
- **Changes are not allowed on Rapid Program or Express Program orders after the order has been entered and acknowledged.**
4. Consult Customer Service at 1-877-671-7011 for items not shown in the price list.
5. Check all acknowledgments carefully, and immediately, for discrepancies. If an error is identified please contact Customer Care immediately.
6. Expedite requests will be considered and accommodated when possible. Orders that are expedited are subject to a discount reduction. Contact Customer Care for considerations and discounting detail.

ORDER SUBMISSION:

Orders are submitted to Steelcraft through OEW (Order Entry Works), fax or e-mail:

1. OEW orders (Steelcraft's preferred method of receiving orders):

- Orders receive an additional discount, contact your local Sales Office for discount information.
- Stock orders also receive an additional discount, contact your local Sales Office for discount information.
- Additional products and features are available when ordered through OEW. See Programs page for details.

2. Faxed and e-mailed orders:

- Orders must be submitted on Steelcraft order forms.
- Refer to Allegion's Distributor Portal to download order forms.
- Rapid Program orders must be submitted through OEW to receive quoted discounts.
- Orders will be processed on a first come first served basis with OEW orders taking precedence.
- Shop drawings and hardware schedules are not considered a purchase order

SDI CERTIFIED MATERIAL AND PERFORMANCE STANDARDS AND SPECIFICATIONS:

Steelcraft conforms to the latest version of ANSI/SDI A250.8 standards from the Steel Door Institute, and is recognized by the "SDI Certified" mark on product packaging and literature.

Commercial quality materials are supplied as specified in ANSI/SDI A250.8 Products > General > Steel Specifications, and are identified by Steelcraft in this and other literature and customer communications as follows:

- Cold Rolled Steel (CRS or CR) for normal/interior use.
- Galvanealed Steel (GALV) for exterior openings or for interior openings with high humidity/when requiring rust prohibitive properties.
- GRAINTECH™ woodgrain embossment for hand stained steel doors available in 18 or 16 gauge galvanealed only, limited to series L, CE, T.
- Stainless for exterior, sterile, or special architectural openings.

Refer to the Steelcraft Technical Data Manual, General Information for a full list of SDI, ANSI, and ASTM Standards.

BLUE ASH:

EXPRESS STOCK:

2 day lead-time from 1pm EST cutoff

- Applies to all KWIK-PAK doors, frames and stock package part.
- Orders accepted through OEW only and subject to a 2 point reduction from current buying program discount.

EXPRESS FRAMES:

3 day lead time from order date and cutoff time

- Applies to all 3-sided frames as shown on program bulletin.
- Express Service subject to increased charges applied to either buying program or project quote.
- Available through OEW only
- See program page for additional information.

STOCK:

5 day lead-time from order cutoff day

- Applies to all stock products listed in the Stock section of this Price Book or on order form Steelcraft Cat. #663 and non-shaded items in Parts Section.

RAPID :

10 day lead-time from order cutoff day

- When ordering via OEW all door and frame products are available with the below exceptions. See Rapid Programs Section.

Door exceptions:

- Stainless steel
- Factory installation
 - INPACT™ Integrated Door System
 - Installed astragals
 - LM9300 devices
 - Von Duprin Concealed Vertical Cables
- PW, B & A14 Series Doors
- Factory finished paint
- GRAINTECH™ factory stained

Frame exceptions:

- Stainless steel
- 12 gauge frames
- All elevations other than four (4) sided borrowed light frames and current stick-shop material
- Factory welding will add (1) week for 3-sided material and (2) weeks for elevations
- FT-Series frames
- Pocket frames

STICK SHOP – Stock elevations:

10 day lead-time from order cutoff day

- Applies to all stock stick material in the Stick section of the Price Book.
- All material is saw cut and notched as ordered.

STANDARD - Non-stock doors, frames and elevations:

4 week lead-time from order cutoff day

WEST COAST SERVICE CENTER:

All material will ship out of the West Coast Service Center.

EXPRESS STOCK:

1 day lead-time from 1pm EST cutoff

- Applies to all stock products listed in the West Coast Stock section of the Price Book.
- Orders accepted through OEW only and subject to a 2 point reduction from current buying program discount.

STOCK & MODIFIED STOCK:

5 day lead-time from order cutoff day

- All frame and door material listed in the West Coast Stock section of the Price Book.
- Refer to the modified stock pages in the Stock section of the Price Book.
- Blue Ash stock can be ordered through the RAPID program.

RAPID:

12 day lead-time from order cutoff day

- When ordering via OEW all door and frame products are available with the below exceptions. See Rapid Programs Section.

Door exceptions:

- Stainless steel
- Factory installation
 - INPACT™ Integrated Door System
 - Installed astragals
 - LM9300 devices
 - Von Duprin Concealed Vertical Cables
- PW, B & A14 Series Doors
- Factory finished paint
- GRAINTECH™ factory stained

Frame exceptions:

- Stainless steel
- 12 gauge frames
- All elevations other than four (4) sided borrowed light frames and current stick-shop material
- Factory welding will add (1) week for 3-sided material and (2) weeks for elevations
- FT-Series frames
- Pocket frames

STICK SHOP – Stock elevations:

12 day lead-time from order cutoff day

- Applies to all stock stick material in the Stick section of the Price Book.
- All material is die-mitered for standard profile product from service center.

STANDARD - Non-stock door, frames and elevations:

4-5 week lead-time from order cutoff day

Prices subject to change without notice.

		Expanded offerings when order placed through OEW
Frame Series:	<ul style="list-style-type: none"> • F & FP Series • DW / K Series • C / CK Series • MU Series • FE Series 	<ul style="list-style-type: none"> • Knocked down (KD) only • Prep for 1 3/4" thick door • Variations in rabbet, stop and returns are not available • 2" face jambs and 2" or 4" face heads
Frame Material:	<ul style="list-style-type: none"> • 16 Gauge • 14 Gauge • CRS or A 60 	<ul style="list-style-type: none"> • F, MU, DW, FE or K • F, FE • F, MU, DW, FE or K.....
Jamb Depth Range (min / max):	<ul style="list-style-type: none"> • F and MU: (Note: Wire masonry anchors only for jamb depths larger than 9 1/2") <ul style="list-style-type: none"> • Single Rabbet • Unequal Rabbet • Equal Rabbet • Cased Open • K / DW • FE (masonry anchors only) 	<ul style="list-style-type: none"> • 3 3/4" to 14 3/4" • 4 1/2" to 14 3/4" • 4 7/8" to 14 3/4" • 4 1/2" to 14 3/4" • 4 1/2" to 14 3/4" • 5 3/4", 6 3/4", 7 3/4" and 8 3/4"
Frame Opening Sizes (min / max):	<ul style="list-style-type: none"> • Jamb • Head 	<ul style="list-style-type: none"> • Equal to series (min/max) sizes
Frame Face Sizes: (3-sided and component pieces, double rabbet)	<ul style="list-style-type: none"> • 2" face jambs and 2" or 4" face heads • F, MU, DW, FE or K Series 	<ul style="list-style-type: none"> • Special faces (1 1/4", 1 1/2", 1 3/4") • 1" face • F and MU Series • FN Series
Frame Hardware:	<ul style="list-style-type: none"> • Hinges • Continuous Hinges • Two (2) pair of hinges • Strikes • Closers • Flushbolts • Silencers • Deadlock Strikes • Standard CYL and ASA • Coordinators 	<ul style="list-style-type: none"> • Blank, 4 1/2" or 5" at standard Steelcraft locations and special vertical locations • With or without reinf. Default is without reinf. unless specified otherwise • In lieu of 1 1/2 pair • ASA, RPD, or VRPD reinf. at standard Steelcraft locations and special vertical location..... • RA, PA, TJ or full-width • Standard, non templated and standard or special location for unequal pairs of doors • Factory punched for field installation • Preps ordered by Steelcraft Cat. #535 only • Strike preps in head. Location to centerline of strike required
Labels:	<ul style="list-style-type: none"> • UL labels and ITS/WHI labels 	<ul style="list-style-type: none"> • Available where applicable. Indicate hourly rating
Frame Products:	<ul style="list-style-type: none"> • Dutch frames • Borrowed Lights - Four (4) sided KD • Communicating • Pierce and dimple • Jamb Anchors • Base anchor 	<ul style="list-style-type: none"> • 4 1/2" through 14 3/4" jamb depth. 6'8", 7'0" and 7'2" heights (non-label only) • 4 1/2" to 14 3/4" jamb depth maximum dependent on frame series. Glazing beads required on labeled only • Equal and unequal rabbet 4 1/2" to 14 3/4" jamb depth maximum, dependent on frame series • EMA anchors. Anchors not included • Lock in standard jamb depth wood or steel stud anchors (not available on FE) • Lock in universal wood or steel stud anchors (not available on FE) • Masonry T-Anchors 5 3/4", 6 3/4", 7 3/4" and 8 3/4" jamb depth • Welded in F, MU and FE
		<ul style="list-style-type: none"> • DW, MU or K • G 90 available • Special jamb depths • 5 3/4" – 14" jamb depth • Pivot preps • CVRPD • 12 ga. head reinf. channel • Concealed (track in door) • Manufacturers numbers • Electric strikes • Door position switches • Electric hinges • Power transfers • Soffit, face or templated • FM labels • Hospital stops • Welded in wood stud steel stud 4" and 6 1/2" nailing clip or EMA hat anchors • Weld in anchors available on FE • F, DW, MU and K • Kerf frame (3-hr. rated)

GENERAL INFORMATION

		Expanded offerings when order placed through OEW
Door Series: <ul style="list-style-type: none"> • L Series • CE Series • SL Series 	<ul style="list-style-type: none"> • LF Series (honeycomb, polystyrene or polyurethane) • CF Series • SZ Series 	<ul style="list-style-type: none"> • H, HF, HE and HW Series • LW Series • T and TW Series
Door Material: <ul style="list-style-type: none"> • 18 Gauge • 16 Gauge • CRS or A 60 	<ul style="list-style-type: none"> • L, CE, SZ • L, CE..... • L..... 	<ul style="list-style-type: none"> • 14 gauge (L, T and H Series) • H Series • H Series
Door Opening Sizes (min / max): <ul style="list-style-type: none"> • Height • Width • Pairs of doors • Wide inactive <p>NOTE: Refer to the Steelcraft Tech Data Manual for maximum width and height limitations by door series.</p>		
Door Design Type: <ul style="list-style-type: none"> • F (Flush) • Glass lights • Dutch door 	<ul style="list-style-type: none"> • Designer Trim 1/4" or 1/2" thick glass only • Light or louver cutout - label or non-label • Dutch doors 6'8", 7'0" and 7'2" heights only, single swing, non-label • 1 3/4" transom panels • Laminated panels 	<ul style="list-style-type: none"> • Lights for glass over 1/2" thick
Door Hardware: <ul style="list-style-type: none"> • Hinges • Continuous Hinges • Two (2) pair of hinges • Locks • 86 Lock sectional trim • Mortise exits • Rim exits • Surface VR exit • Deadlocks • Closers • Holders and Stops • Flushbolts • Steel caps 	<ul style="list-style-type: none"> • Blank, 4 1/2" or 5" at standard Steelcraft and special vertical locations • With or without reinf. Default is without reinf. unless specified otherwise • In lieu of 1 1/2 pair • 161, 61L, 86, 86ED, 86EDR, RPD, VRPD, PP, Blank, ASA, ASAV at standard Steelcraft and special vertical locations • Per Steelcraft Cat. #652 • Per Steelcraft Cat. #556 • Per Steelcraft Cat. #541 • Per Steelcraft Cat. #705 • Per Steelcraft Cat. #535..... • Standard closer reinf. top of door..... • OEW orders only • 6", 12", 24" or 36" top and 12" bottom standard or non-templated • Top and/or bottom caps screwed in 	<ul style="list-style-type: none"> • Pivot preps • High frequency hinge • Roller latch • Combo locks • Manufacturers numbers • Manufacturers numbers • Manufacturers numbers • Manufacturers numbers • Manufacturers numbers • Concealed VR exit • Full width • Concealed (track in door) • Electric strikes • Door position switches • Electric hinges • Power transfers • Raceway • Magnetic switch • Flush top channel
Labels: <ul style="list-style-type: none"> • UL labels and ITS/WHI labels 	<ul style="list-style-type: none"> • Available where applicable. Indicate hourly rating 	
Finish:		<ul style="list-style-type: none"> • Omit prime paint

Prices subject to change without notice.

TABLE OF CONTENTS

FRAME PRODUCT INFORMATION.....11

FLUSH FRAMES12

 F16 and FN16-Series.....12

 F14 and FN14-Series.....14

 F12-Series.....16

 MU16-Series 18

 MU14-Series..... 20

 FE16 and DE16-Series.....22

 FE14 and DE14-Series.....22

DRYWALL (SLIP-ON) FRAMES 24

 DW16 and K16-Series 24

 DW14 and K14-Series.....26

 FS16-Series29

 MS16-Series.....29

 KS16-Series.....29

 FT16 and FT14-Series 30

 C and CK-Series.....34

CUSTOM FRAMES CONSTRUCTION OPTIONS..... 38

Prices subject to change without notice.

FRAME PRICING GUIDELINES AND POLICIES: The following guidelines and policies are followed when applying pricing to frames. Refer to the following price pages for the appropriate frame series and options.

GENERAL:

Three (3) sided frames and components (jambs and heads) are supplied standard factory prime painted and knock down for field assembly. Special profile frames, depending on profile and specification requirements, are supplied as die mitered pieces, ready for field or factory welding prior to installation.

ANCHORS:

Standard frames and jamb components include the following standard anchors:

1. F and MU-Series frames:

- Anchor quantities:
 - 3 per jamb up to 7'6"
 - 4 per jamb over 7'6"
- Standard anchors at no charge:
 - Wire masonry, "T"-masonry, wood stud or steel stud
 - Adjustable base anchors
- Optional deduct for frames without anchors:
 - Deduct anchor price per individual price sheets
- Optional special anchors with an up charge:
 - Optional masonry EMA, "Tube and Strap" and other anchors available from the parts section of this price book
 - Optional weld-in anchors and anchors for special profile frames are available (see custom frame options page)

2. FE and DE-Series frames:

- Masonry wall anchor quantities:
 - 3 per jamb up to 7'6"
 - 4 per jamb over 7'6"
- Stud (wood or steel) wall anchor quantities (weld-in):
 - 4 per jamb up to 7'6"
 - 5 per jamb over 7'6"
- Standard anchors at no charge:
 - Wire masonry supplied standard
 - Welded in base anchors
- Optional deduct for frames without anchors:
 - Deduct anchor price per individual price sheets
- Optional special anchors with an up charge:
 - Optional masonry EMA "Tube and Strap" and other anchors available from the parts section of this price book
 - Optional weld-in anchors and anchors for special profile frames are available (see custom frame options page)

3. DW and K-Series frames:

- Adjustable compression anchor supplied standard
- Base anchors:
 - DW-Series frames supplied standard with twist-in base anchors
 - K-Series frames supplied with face pierced and dimpled for visible anchoring

FRAME COMPONENTS (JAMBS and HEADS):

1. Hinge Jamb preps:

- Number of hinges based on door height:
 - 2 hinges – up to 5'0" high
 - 3 hinges – 5'0" and up to and including 7'6" high

NOTE: 6'8" high frames for 1³/₈" doors are standard with 2 hinge preps

 - 4 hinges – over 7'6" high
- Standard hinge prep at no charge:
 - 4¹/₂" Universal hinge preps
 - 4¹/₂" standard weight prep for DW and K-Series
- Optional hinge preps at no charge:
 - 5" Universal hinge preps
 - Blank hinge - no hinge preps, no reinf.
 - Continuous hinge - no reinforcing standard
- Optional hinge preps with an up charge:
 - Refer to the individual price pages and the hardware preps section of this price book

2. Strike Jamb preps (one prep included):

- Standard strike prep at no charge:
 - 4⁷/₈" ANSI strike (ANSI/BHMA A156.115.1-2)
 - 3 preps for field installed silencers
- Optional strike preps at no charge:
 - 2³/₄" ANSI strike (ANSI/BHMA A156.115.3)
 - Blank strike
- No strike preps, no reinf.
- Optional strike preps with an up charge:
 - Refer to the individual price pages and the hardware preps section of this price book

3. Head preps:

- Single door openings:
 - Up to and including 4'0" door opening size
 - No prep as standard
 - Optional preps with an up charge:
- Refer to the individual price pages and the hardware preps section of this price book
- Double door openings:
 - All door opening sizes over 4'0"
 - 2 silencer preps located from the centerline
 - Optional preps at no charge
- Omit silencer preps for single door
 - Optional preps with an up charge
- Refer to the individual price pages and the hardware preps section of this price book

Prices subject to change without notice.

COMPLETE FRAME PRICING

Single Frame		JAMB DEPTH				
Width	Height	3"-5 ⁷ / ₈ "	6"-7 ⁷ / ₈ "	8"-9 ⁷ / ₈ "	10"-11 ⁷ / ₈ "	12"-14 ³ / ₄ "
1'6" thru 3'0"	6'8"	\$290	\$317	\$354	\$394	\$464
	7'0"	\$300	\$335	\$365	\$408	\$479
	7'2"	\$316	\$349	\$384	\$429	\$502
	8'0"	\$377	\$394	\$430	\$478	\$555
	9'0"	\$417	\$448	\$473	\$530	\$614
Over 3'0" thru 4'0"	10'0"	\$471	\$503	\$536	\$593	\$682
	6'8"	\$306	\$334	\$368	\$409	\$477
	7'0"	\$316	\$352	\$379	\$423	\$492
	7'2"	\$332	\$366	\$398	\$444	\$515
	8'0"	\$393	\$411	\$444	\$493	\$568
9'0"	\$433	\$465	\$487	\$545	\$627	
10'0"	\$487	\$520	\$550	\$608	\$695	

Double Frame		JAMB DEPTH				
Width	Height	3"-5 ⁷ / ₈ "	6"-7 ⁷ / ₈ "	8"-9 ⁷ / ₈ "	10"-11 ⁷ / ₈ "	12"-14 ³ / ₄ "
4'0" thru 6'0"	6'8"	\$358	\$386	\$427	\$469	\$539
	7'0"	\$366	\$402	\$439	\$481	\$553
	7'2"	\$384	\$424	\$459	\$503	\$583
	8'0"	\$460	\$476	\$511	\$561	\$643
	9'0"	\$504	\$534	\$559	\$615	\$701
Over 6'0" thru 8'0"	10'0"	\$560	\$592	\$631	\$687	\$785
	6'8"	\$381	\$411	\$457	\$498	\$570
	7'0"	\$389	\$427	\$469	\$510	\$584
	7'2"	\$407	\$449	\$489	\$532	\$614
	8'0"	\$483	\$501	\$541	\$590	\$674
Over 8'0" thru 10'0"	9'0"	\$527	\$559	\$589	\$644	\$732
	10'0"	\$583	\$617	\$661	\$716	\$816
	6'8"	\$418	\$451	\$504	\$551	\$624
	7'0"	\$426	\$467	\$516	\$563	\$638
	7'2"	\$444	\$489	\$536	\$585	\$668
8'0"	\$520	\$541	\$588	\$643	\$728	
9'0"	\$564	\$599	\$636	\$697	\$786	
10'0"	\$620	\$657	\$708	\$769	\$870	

COMPONENT PART PRICING

JAMB DEPTH						
Part	Height	3"-5 ⁷ / ₈ "	6"-7 ⁷ / ₈ "	8"-9 ⁷ / ₈ "	10"-11 ⁷ / ₈ "	12"-14 ³ / ₄ "
Strike Jamb	6'8"	\$112	\$121	\$134	\$147	\$171
	7'0"	\$118	\$131	\$139	\$155	\$179
	7'2"	\$125	\$134	\$148	\$165	\$187
	8'0"	\$148	\$153	\$168	\$185	\$210
	9'0"	\$166	\$178	\$187	\$210	\$240
	10'0"	\$192	\$204	\$214	\$237	\$266
Hinge Jamb	6'8"	\$125	\$135	\$150	\$164	\$188
	7'0"	\$129	\$143	\$156	\$170	\$195
	7'2"	\$138	\$154	\$166	\$181	\$210
	8'0"	\$176	\$180	\$192	\$210	\$240
	9'0"	\$198	\$209	\$216	\$237	\$269
	10'0"	\$226	\$238	\$252	\$273	\$311
JAMB DEPTH						
Part	Width	3"-5 ⁷ / ₈ "	6"-7 ⁷ / ₈ "	8"-9 ⁷ / ₈ "	10"-11 ⁷ / ₈ "	12"-14 ³ / ₄ "
Head	Thru 3'0"	\$53	\$61	\$70	\$83	\$105
	Thru 4'0"	\$69	\$78	\$84	\$98	\$118
	Thru 5'0"	\$98	\$104	\$113	\$127	\$149
	Thru 6'0"	\$108	\$116	\$127	\$141	\$163
	Thru 8'0"	\$131	\$141	\$157	\$170	\$194
	Thru 10'0"	\$168	\$181	\$204	\$223	\$248

NOTES:

1. Jamb Depths:

- 4 1/2" and larger are double rabbet as standard
- 3" thru 4 3/8" are supplied single rabbet
- All frames listed are available in jamb depth increments of 1/8"

2. Door Opening Sizes:

- Standard frame sizes are listed
- Any non-standard frame width and/or height is priced as the next larger size frame category. See page 38 for special size limit.
- Maximum size:
 - Single: 4'0" x 10'0"
 - Double: 10'0" x 10'0"

3. FN-Series Frames (1" Face):

- Available as double rabbet only
- Weld-in fixed base anchor standard

4. Cased Open Frames:

- Priced as two (2) strike jambs and head from Component Part Pricing
- Weld-in fixed base anchor standard

LABELED FRAMES: (NO CLOSER REINF)	Single	Pair
UL (no closer reinf)		
• Metal label	\$28	\$56
• 3 hr in stud partition (includes stiffeners in head)	\$34	\$68
ITS/WHI (no closer reinf)		
• Metal label	\$28	\$56
• Mylar label	\$21	\$42
• Mylar label smoke & draft	\$21	\$42
FM (no closer reinf)		
• Mylar label	\$21	\$42

Refer to the Steelcraft Tech Data Manual for all labeled approvals.

16 GAUGE FLUSH FRAMES

FOR 1³/₄" OR 1³/₈" DOORS

F16 and FN16-SERIES

FRAMES

Standard Construction Options: Per frame

GALVANNEALED A-60 STEEL:	
• Complete frame	\$53
• Per jamb	\$20
• Per head	\$13

GALVANIZED G-90 STEEL:	
• Complete frame	\$99
• Per jamb	\$37
• Per head	\$25
• Maximum opening height 9'10"	

4" FACE HEAD:	Thru 4'0"	Over 4'0"
	\$57	\$81

MARK NUMBERS N/C

EQUAL RABBIT N/C

DUTCH FRAME:	Non-Labeled	Labeled
	\$52	\$131

COMMUNICATING FRAMES:	
• Single openings only	\$81
• Specify if doors swing from the same or opposite jambs	

SPECIAL PROFILE FRAMES:	
• Refer to Custom Frame Options section for pricing	
• Special anchor charges will apply	

HOSPITAL SANITARY STOPS (4", 5 ¹ / ₂ " and 6" high standard):	
• Single rabbit 45° only	\$216
• Double rabbit 45°	\$216
• Double rabbit 90°	\$216

ANCHORS (Factory welded or prepped):		
	Per frame	
	Thru 9¹/₈"	Over 9¹/₈"
• Welded-in standard anchors (in lieu of loose)		
• Base	N/C	N/C
• Jambs thru 7'6"	\$42	\$60
• Jambs over 7'6" thru 10'0"	\$56	\$80
• Each additional	\$7	\$10
• EMA (pierce and dimple only)		
• Jambs thru 7'1"	\$44	\$88
• Jambs over 7'1" thru 8'9"	\$55	\$110
• Jambs over 8'9" thru 10'0"	\$66	\$132
• Each additional	\$5.50	\$11
• EMA (pierce, dimple, weld-in anchors with bolts)		
• Jambs thru 7'1"	\$186	\$372
• Jambs over 7'1" thru 8'9"	\$232.50	\$465
• Jambs over 8'9" thru 10'0"	\$279	\$558
• Each additional	\$23.25	\$46.50

Note – Other EMA configuration pricing available, see custom frame option page

ANCHORS (Standard loose / lock-in):		
• Deletion of anchors (deduct from standard frame price)		
	Per jamb	Per frame
• Base	\$3.25	\$6.50
• Jambs thru 7'6"	\$9.75	\$19.50
• Jambs over 7'6"	\$13	\$26

Prices subject to change without notice.

Standard Hardware Options: Per prep

12 GAUGE HEAD REINFORCING CHANNEL:	
(2" face only, full jamb depth)	\$192

SPECIAL VERTICAL HARDWARE LOCATIONS:	
• Hinge and lock	N/C

CLOSERS:	
• Surface mounted:	
• 14" strap installed	\$28
(specify regular, parallel arm or top jamb)	
• Closer sleeve installed	\$58
• Concealed in head (per template)	\$281
• ALLE Concealed in head (per template)	\$254

HINGES:	
• 5" Universal in lieu of 4 ¹ / ₂ "	N/C
• Additional hinge prep (4 ¹ / ₂ " or 5")	\$21
• High frequency prep	\$25
• Continuous hinge:	
• No reinf. (blank jamb)	N/C
• Full length reinf.	\$81

STRIKES:	
• Additional ASA (4 ⁷ / ₈ " ANSI A115.1-2)	\$21
• Additional Cylindrical (2 ³ / ₄ " ANSI A115.3)	\$21
(minimum 7" above or below standard strike)	
• Double Cylindrical (2 ³ / ₄ " on 4" centers	\$42
• Deadlock (non-tip)	\$21
• Flushbolts:	
• Steelcraft reversible	\$57
• Standard (ANSI 115.4)	\$57
• Surface Bolt reinf.	\$29
• Exit Devices:	
• Rim reinf. only	\$29
• Vertical Rod reinf. only	\$29
• Vertical Rod Mortise strike (each)	\$67
• Roller latch (each)	\$43

ELECTRICAL PREPS:	
• Power transfer units (i.e. EPT2, EPT10, etc.)	\$133
• Electric hinge prep	\$53
• Electric strike prep	\$98
• Door position switch (1 ¹ / ₂ " to 1" dia.)	\$53
• Magnetic switch (rectangular and mortised)	\$119

- NOTES:**
1. Power transfers, electric strikes and concealed closers are not available on FN-Series frames.
 2. Electric preps come standard with mortar guards on standard profile products, including knock-outs.

 Indicates products that have EPD documentation available and meet LEED v4.

COMPLETE FRAME PRICING

Single Frame		JAMB DEPTH				
Width	Height	3"-5 ⁷ / ₈ "	6"-7 ⁷ / ₈ "	8"-9 ⁷ / ₈ "	10"-11 ⁷ / ₈ "	12"-14 ³ / ₄ "
1'6" thru 3'0"	6'8"	\$359	\$382	\$416	\$468	\$551
	7'0"	\$365	\$398	\$430	\$483	\$567
	7'2"	\$389	\$419	\$449	\$501	\$591
	8'0"	\$450	\$471	\$501	\$558	\$644
	9'0"	\$499	\$530	\$561	\$621	\$721
	10'0"	\$555	\$581	\$620	\$683	\$793
Over 3'0" thru 4'0"	6'8"	\$368	\$392	\$426	\$481	\$558
	7'0"	\$374	\$408	\$440	\$496	\$574
	7'2"	\$398	\$429	\$459	\$514	\$598
	8'0"	\$459	\$481	\$511	\$571	\$651
	9'0"	\$508	\$540	\$571	\$634	\$728
	10'0"	\$564	\$591	\$630	\$696	\$800

Double Frame		JAMB DEPTH				
Width	Height	3"-5 ⁷ / ₈ "	6"-7 ⁷ / ₈ "	8"-9 ⁷ / ₈ "	10"-11 ⁷ / ₈ "	12"-14 ³ / ₄ "
4'0" thru 6'0"	6'8"	\$426	\$456	\$489	\$547	\$627
	7'0"	\$436	\$470	\$507	\$555	\$637
	7'2"	\$458	\$496	\$527	\$577	\$671
	8'0"	\$534	\$556	\$585	\$643	\$731
	9'0"	\$588	\$614	\$647	\$709	\$809
	10'0"	\$644	\$672	\$717	\$769	\$887
Over 6'0" thru 8'0"	6'8"	\$451	\$483	\$520	\$584	\$663
	7'0"	\$461	\$497	\$538	\$592	\$673
	7'2"	\$483	\$523	\$558	\$614	\$707
	8'0"	\$559	\$583	\$616	\$680	\$767
	9'0"	\$613	\$641	\$678	\$746	\$845
	10'0"	\$669	\$699	\$748	\$806	\$923
Over 8'0" thru 10'0"	6'8"	\$497	\$535	\$582	\$648	\$730
	7'0"	\$507	\$549	\$600	\$656	\$740
	7'2"	\$529	\$575	\$620	\$678	\$774
	8'0"	\$605	\$635	\$678	\$744	\$834
	9'0"	\$659	\$693	\$740	\$810	\$912
	10'0"	\$715	\$751	\$810	\$870	\$990

COMPONENT PART PRICING

JAMB DEPTH						
Part	Height	3"-5 ⁷ / ₈ "	6"-7 ⁷ / ₈ "	8"-9 ⁷ / ₈ "	10"-11 ⁷ / ₈ "	12"-14 ³ / ₄ "
Strike Jamb	6'8"	\$138	\$145	\$153	\$170	\$198
	7'0"	\$139	\$154	\$158	\$181	\$209
	7'2"	\$152	\$162	\$167	\$188	\$216
	8'0"	\$175	\$184	\$190	\$212	\$239
	9'0"	\$197	\$214	\$219	\$242	\$277
	10'0"	\$225	\$236	\$243	\$274	\$310
Hinge Jamb	6'8"	\$148	\$158	\$169	\$190	\$217
	7'0"	\$153	\$165	\$178	\$194	\$222
	7'2"	\$164	\$178	\$188	\$205	\$239
	8'0"	\$202	\$208	\$217	\$238	\$269
	9'0"	\$229	\$237	\$248	\$271	\$308
	10'0"	\$257	\$266	\$283	\$301	\$347
JAMB DEPTH						
Part	Width	3"-5 ⁷ / ₈ "	6"-7 ⁷ / ₈ "	8"-9 ⁷ / ₈ "	10"-11 ⁷ / ₈ "	12"-14 ³ / ₄ "
Head	Thru 3'0"	\$73	\$79	\$94	\$108	\$136
	Thru 4'0"	\$82	\$89	\$104	\$121	\$143
	Thru 5'0"	\$116	\$128	\$140	\$160	\$178
	Thru 6'0"	\$130	\$140	\$151	\$167	\$193
	Thru 8'0"	\$155	\$167	\$182	\$204	\$229
	Thru 10'0"	\$201	\$219	\$244	\$268	\$296

NOTES:

1. Jamb Depths:

- 4 1/2" and larger are double rabbet as standard
- 3" thru 4 3/8" are supplied single rabbet
- All frames listed are available in jamb depth increments of 1/8"

2. Door Opening Sizes:

- Standard frame sizes are listed
- Any non-standard frame width and/or height is priced as the next larger size frame category. See page 38 for special size limit.
- Maximum size:
 - Single: 4'0" x 10'0"
 - Double: 10'0" x 10'0"

3. FN-Series Frames (1" Face):

- Available as double rabbet only
- Weld-in fixed base anchor standard

4. Cased Open Frames:

- Priced as two (2) strike jambs and head from Component Part Pricing
- Weld-in fixed base anchor standard

LABELED FRAMES: (NO CLOSER REINF)	Single	Pair
UL (no closer reinf)		
• Metal label	\$28	\$56
• 3 hr in stud partition (includes stiffeners in head)	\$34	\$68
ITS/WHI (no closer reinf)		
• Metal label	\$28	\$56
• Mylar label	\$21	\$42
• Mylar label smoke & draft	\$21	\$42
FM (no closer reinf)		
• Mylar label	\$21	\$42

Refer to the Steelcraft Tech Data Manual for all labeled approvals.

14 GAUGE FLUSH FRAMES FOR 1³/₄" DOORS

Standard Construction Options: Per frame

GALVANNEALED A-60 STEEL:

- Complete frame.....\$53
- Per jamb.....\$20
- Per head.....\$13

GALVANIZED G-90 STEEL:

- Complete frame.....\$99
- Per jamb.....\$37
- Per head.....\$25
- Maximum opening height 9'10"

4" FACE HEAD:

	Thru 4'0"	Over 4'0"
	\$57.....	\$81

MARK NUMBERS..... N/C

EQUAL RABBET..... N/C

DUTCH FRAME:

	Non-Labeled	Labeled
	\$52.....	\$131

COMMUNICATING FRAMES:

- Single openings only.....\$81
- Specify if doors swing from the same or opposite jambs

SPECIAL PROFILE FRAMES:

- Refer to Custom Frame Options section for pricing
- Special anchor charges will apply

HOSPITAL SANITARY STOPS (4", 5¹/₂" and 6" high standard):

- Single rabbet 45° only.....\$216
- Double rabbet 45°.....\$216
- Double rabbet 90°.....\$216

ANCHORS (Factory welded or prepped):

	Per frame	
	Thru 9¹/₈"	Over 9¹/₈"
• Welded-in standard anchors (in lieu of loose)		
• Base.....	N/C.....	N/C
• Jambs thru 7'6".....	\$42.....	\$60
• Jambs over 7'6" thru 10'0".....	\$56.....	\$80
• Each additional.....	\$7.....	\$10
• EMA (pierce and dimple only)		
• Jambs thru 7'1".....	\$44.....	\$88
• Jambs over 7'1" thru 8'9".....	\$55.....	\$110
• Jambs over 8'9" thru 10'0".....	\$66.....	\$132
• Each additional.....	\$5.50.....	\$11
• EMA (pierce, dimple, weld-in anchors with bolts)		
• Jambs thru 7'1".....	\$186.....	\$372
• Jambs over 7'1" thru 8'9".....	\$232.50.....	\$465
• Jambs over 8'9" thru 10'0".....	\$279.....	\$558
• Each additional.....	\$23.25.....	\$46.50

Note – Other EMA configuration pricing available, see custom frame option page

ANCHORS (Standard loose / lock-in):

- Deletion of anchors (deduct from standard frame price)

	Per jamb	Per frame
• Base.....	\$3.25.....	\$6.50
• Jambs thru 7'6".....	\$9.75.....	\$19.50
• Jambs over 7'6".....	\$13.....	\$26

Standard Hardware Options: Per prep

12 GAUGE HEAD REINFORCING CHANNEL:

- (2" face only, full jamb depth).....\$192

SPECIAL VERTICAL HARDWARE LOCATIONS:

- Hinge and lock..... N/C

CLOSERS:

- Surface mounted:
 - 14" strap installed.....\$28
 - (specify regular, parallel arm or top jamb)
 - Closer sleeve installed.....\$58
- Concealed in head (per template).....\$281
- ALLE Concealed in head (per template).....\$254

HINGES:

- 5" Universal in lieu of 4¹/₂"..... N/C
- Additional hinge prep (4¹/₂" or 5").....\$21
- High frequency prep.....\$25
- Continuous hinge:
 - No reinf. (blank jamb)..... N/C
 - Full length reinf.\$81

STRIKES:

- Additional ASA (4⁷/₈" ANSI A115.1-2).....\$21
- Additional Cylindrical (2³/₄" ANSI A115.3).....\$21
- (minimum 7" above or below standard strike)
- Double Cylindrical (2³/₄" on 4" centers).....\$42
- Deadlock (non-lip).....\$21
- Flushbolts:
 - Steelcraft reversible.....\$57
 - Standard (ANSI 115.4).....\$57
- Surface Bolt reinf.\$29
- Exit Devices:
 - Rim reinf. only.....\$29
 - Vertical Rod reinf. only.....\$29
 - Vertical Rod Mortise strike (each).....\$67
- Roller latch (each).....\$43

ELECTRICAL PREPS:

- Power transfer units (i.e. EPT2, EPT10, etc.).....\$133
- Electric hinge prep.....\$53
- Electric strike prep.....\$98
- Door position switch (1/2" to 1" dia.).....\$53
- Magnetic switch (rectangular and mortised).....\$119

- NOTES:**
1. Power transfers, electric strikes and concealed closers are not available on FN-Series frames.
 2. Electric preps come standard with mortar guards on standard profile products, including knock-outs.

Prices subject to change without notice.

Indicates products that have EPD documentation available and meet LEED v4.

COMPLETE FRAME PRICING

Single Frame		JAMB DEPTH				
Width	Height	4 ³ / ₄ "-5 ⁷ / ₈ "	6"-7 ⁷ / ₈ "	8"-9 ⁷ / ₈ "	10"-11 ⁷ / ₈ "	12"-12 ³ / ₄ "
1'6" thru 3'0"	6' 8"	\$633	\$674	\$759	\$880	\$1,010
	7' 0"	\$642	\$699	\$776	\$913	\$1,052
	7'2"	\$665	\$720	\$795	\$951	\$1,097
	8' 0"	\$757	\$810	\$892	\$1,049	\$1,210
Over 3'0" thru 4'0"	8'8"	\$815	\$897	\$980	\$1,122	\$1,311
	6' 8"	\$664	\$702	\$788	\$907	\$1,044
	7' 0"	\$673	\$727	\$805	\$940	\$1,086
	7'2"	\$696	\$748	\$824	\$978	\$1,131
Over 4'0"	8' 0"	\$788	\$838	\$921	\$1,076	\$1,244
	8'8"	\$846	\$925	\$1,009	\$1,149	\$1,345

Double Frame		JAMB DEPTH				
Width	Height	4 ³ / ₄ "-5 ⁷ / ₈ "	6"-7 ⁷ / ₈ "	8"-9 ⁷ / ₈ "	10"-11 ⁷ / ₈ "	12"-12 ³ / ₄ "
Over 4'0" thru 6'0"	6' 8"	\$777	\$811	\$909	\$1,015	\$1,166
	7' 0"	\$783	\$827	\$927	\$1,049	\$1,214
	7'2"	\$813	\$857	\$947	\$1,097	\$1,256
	8' 0"	\$921	\$971	\$1,063	\$1,203	\$1,392
Over 6'0" thru 8'0"	8'8"	\$979	\$1,047	\$1,145	\$1,271	\$1,482
	6' 8"	\$826	\$870	\$986	\$1,135	\$1,300
	7' 0"	\$832	\$886	\$1,004	\$1,169	\$1,348
	7'2"	\$862	\$916	\$1,024	\$1,217	\$1,390
Over 8'0"	8' 0"	\$970	\$1,030	\$1,140	\$1,323	\$1,526
	8'8"	\$1,028	\$1,106	\$1,222	\$1,391	\$1,616

COMPONENT PART PRICING

JAMB DEPTH						
Part	Height	4 ³ / ₄ "-5 ⁷ / ₈ "	6"-7 ⁷ / ₈ "	8"-9 ⁷ / ₈ "	10"-11 ⁷ / ₈ "	12"-12 ³ / ₄ "
Strike Jamb	6' 8"	\$234	\$249	\$279	\$328	\$370
	7' 0"	\$240	\$266	\$287	\$344	\$388
	7'2"	\$248	\$272	\$296	\$358	\$412
	8' 0"	\$286	\$305	\$335	\$403	\$457
	8'8"	\$315	\$354	\$382	\$442	\$513
Hinge Jamb	6' 8"	\$270	\$280	\$315	\$358	\$411
	7' 0"	\$273	\$288	\$324	\$375	\$435
	7'2"	\$288	\$303	\$334	\$399	\$456
	8' 0"	\$342	\$360	\$392	\$452	\$524
	8'8"	\$371	\$398	\$433	\$486	\$569
JAMB DEPTH						
Part	Width	4 ³ / ₄ "-5 ⁷ / ₈ "	6"-7 ⁷ / ₈ "	8"-9 ⁷ / ₈ "	10"-11 ⁷ / ₈ "	12"-12 ³ / ₄ "
Head	Thru 3'0"	\$129	\$145	\$165	\$194	\$229
	Thru 4'0"	\$160	\$173	\$194	\$221	\$263
	Thru 6'0"	\$237	\$251	\$279	\$299	\$344
	Thru 8'0"	\$286	\$310	\$356	\$419	\$478

NOTES:

1. Jambs are shipped 2" longer and heads 4" longer than nominal door opening size:

- Jambs and head have square ends as standard
- Machine miter and notch not available
- Frames must be saw mitered and welded for final assembly
- Silencer preps are not available

2. Jamb Depths and Profiles:

- All frames are equal rabbet as standard
 - Jamb depths less than 5³/₄" are unequal rabbet
- All frames listed are available in jamb depth increments of 1/8"
- All frames have 3/4" high stops

3. Door Opening Sizes:

- Standard frame sizes are listed
- Any non-standard frame width and/or height is priced as the next larger size frame category
- Maximum size:
 - Single: 4'0" x 8'8"
 - Double: 8'0" x 8'8"
 - All members over 8'0" in overall length are supplied as galvanized, add A-60 charges

4. Cased Open Frames:

- Priced as two (2) strike jambs and head from Component Part Pricing
- Weld-in fixed base anchor standard

LABELED FRAMES: (NO CLOSER REINF)	Single	Pair
UL (no closer reinf)		
• Metal label	\$28	\$56
• 3 hr in stud partition (includes stiffeners in head)	\$34	\$68
ITS/WHI (no closer reinf)		
• Metal label	\$28	\$56
• Mylar label	\$21	\$42
• Mylar label smoke & draft	\$21	\$42
FM	N/A	N/A

Refer to the Steelcraft Tech Data Manual for all labeled approvals. F12 Series must be welded from by factory for factory label application.

12 GAUGE FLUSH FRAMES FOR 1³/₄" DOORS

F12-SERIES

FRAMES

Standard Construction Options: Per frame

GALVANNEALED A-60 STEEL:

- Complete frame\$161
- Per jamb\$65
- Per head\$31

GALVANIZED G-90 STEEL: not available

4" FACE HEAD: **Thru 4'0"** **Over 4'0"**
\$57 \$81

MARK NUMBERS: N/C

EQUAL RABBET N/C

DUTCH FRAME: **Non-Labeled** **Labeled**
\$52 not available

COMMUNICATING FRAMES:

- Single openings only\$81
- Specify if doors swing from the same or opposite jambs

SPECIAL PROFILE FRAMES:

- Refer to Custom Frame Options section for pricing
- Special anchor charges will apply

HOSPITAL SANITARY STOPS not available

ANCHORS (Factory welded or prepped):

	Per frame	
	Thru 9 ¹ / ₈ "	Over 9 ¹ / ₈ "
• Welded-in standard anchors (in lieu of loose)		
• Base	N/C	N/C
• Jambs thru 7'6"	\$42	\$60
• Jambs over 7'6" thru 10'0"	\$56	\$80
• Each additional	\$7	\$10
• EMA (pierce and dimple only)		
• Jambs thru 7'1"	\$44	\$88
• Jambs over 7'1" thru 8'9"	\$55	\$110
• Jambs over 8'9" thru 10'0"	\$66	\$132
• Each additional	\$5.50	\$11
• EMA (pierce, dimple, weld-in anchors with bolts)		
• Jambs thru 7'1"	\$186	\$372
• Jambs over 7'1" thru 8'9"	\$232.50	\$465
• Jambs over 8'9" thru 10'0"	\$279	\$558
• Each additional	\$23.25	\$46.50

Note – Other EMA configuration pricing available, see custom frame option page

ANCHORS (Standard loose / lock-in):

• Deletion of anchors (deduct from standard frame price)

	Per jamb	Per frame
• Base	\$3.25	\$6.50
• Jambs thru 7'6"	\$9.75	\$19.50
• Jambs over 7'6"	\$13	\$26

12 GAUGE HEAD REINFORCING CHANNEL not available

Standard Hardware Options: Per prep

SPECIAL VERTICAL HARDWARE LOCATIONS:

- Hinge and lock N/C

CLOSERS:

- Surface mounted
- 14" strap installed \$28
(specify regular, parallel arm or top jamb)
- Concealed in head not available

HINGES:

- 5" Universal in lieu of 4¹/₂" N/C
- Additional hinge prep (4¹/₂" or 5") \$21
- High frequency prep \$25
- Continuous hinge:
 - No reinf. (blank Jamb) N/C
 - Full length reinf.\$81

STRIKES:

- Additional ASA (4⁷/₈" ANSI A115.1-2) \$21
- Additional Cylindrical (2³/₄" ANSI A115.3) \$21
(minimum 7" above or below standard strike)
- Double Cylindrical (2³/₄" on 4" centers) \$42
- Deadlock (non-lip) \$21
- Flushbolts:
 - Steelcraft reversible \$57
 - Standard (ANSI 115.4) \$57
- Exit Devices:
 - Rim reinf. only \$29
 - Vertical Rod reinf. only \$29

ELECTRICAL PREPS:

- Power transfer units (i.e. EPT2, EPT10, etc.) \$133
- Electric hinge prep \$53
- Electric strike prep \$98
- Door position switch (1/2" to 1" dia.) \$53
- Magnetic Switch (rectangular and mortised) \$119

NOTE:

1. Electric preps come standard with mortar guards on standard profile products, including knock-outs.

Prices subject to change without notice.

Indicates products that have EPD documentation available and meet LEED v4.

COMPLETE FRAME PRICING

Single Frame		JAMB DEPTH				
Width	Height	3 ¹ / ₄ "-5 ⁷ / ₈ "	6"-7 ⁷ / ₈ "	8"-9 ⁷ / ₈ "	10"-11 ⁷ / ₈ "	12"-14 ³ / ₄ "
1'6" thru 3'0"	6' 8"	\$309	\$345	\$382	\$426	\$499
	7' 0"	\$321	\$361	\$394	\$441	\$516
	7'2"	\$339	\$377	\$415	\$461	\$541
	8' 0"	\$401	\$427	\$462	\$510	\$597
Over 3'0" thru 4'0"	9'0"	\$447	\$484	\$511	\$567	\$659
	6' 8"	\$326	\$364	\$398	\$442	\$513
	7' 0"	\$338	\$380	\$410	\$457	\$530
	7'2"	\$356	\$396	\$431	\$477	\$555
	8' 0"	\$418	\$446	\$478	\$526	\$611
9'0"	\$464	\$503	\$527	\$583	\$673	

Double Frame		JAMB DEPTH				
Width	Height	3 ¹ / ₄ "-5 ⁷ / ₈ "	6"-7 ⁷ / ₈ "	8"-9 ⁷ / ₈ "	10"-11 ⁷ / ₈ "	12"-14 ³ / ₄ "
4'0" thru 6'0"	6' 8"	\$384	\$420	\$460	\$505	\$581
	7' 0"	\$392	\$432	\$474	\$517	\$595
	7'2"	\$414	\$458	\$496	\$541	\$631
	8' 0"	\$492	\$516	\$550	\$601	\$693
	9'0"	\$544	\$576	\$604	\$659	\$753
Over 6'0" thru 8'0"	6' 8"	\$409	\$448	\$495	\$539	\$615
	7' 0"	\$417	\$460	\$509	\$551	\$629
	7'2"	\$439	\$486	\$531	\$575	\$665
	8' 0"	\$517	\$544	\$585	\$635	\$727
	9'0"	\$569	\$604	\$639	\$693	\$787

COMPONENT PART PRICING

JAMB DEPTH						
Part	Height	3 ¹ / ₄ "-5 ⁷ / ₈ "	6"-7 ⁷ / ₈ "	8"-9 ⁷ / ₈ "	10"-11 ⁷ / ₈ "	12"-14 ³ / ₄ "
Strike Jamb	6' 8"	\$118	\$132	\$144	\$159	\$182
	7' 0"	\$126	\$142	\$149	\$168	\$192
	7'2"	\$133	\$145	\$159	\$176	\$199
	8' 0"	\$156	\$166	\$179	\$195	\$224
	9'0"	\$176	\$193	\$201	\$223	\$256
Hinge Jamb	6' 8"	\$133	\$147	\$161	\$176	\$202
	7' 0"	\$137	\$153	\$168	\$182	\$209
	7'2"	\$148	\$166	\$179	\$194	\$227
	8' 0"	\$187	\$195	\$206	\$224	\$258
	9'0"	\$213	\$225	\$233	\$253	\$288
JAMB DEPTH						
Part	Width	3 ¹ / ₄ "-5 ⁷ / ₈ "	6"-7 ⁷ / ₈ "	8"-9 ⁷ / ₈ "	10"-11 ⁷ / ₈ "	12"-14 ³ / ₄ "
Head	Thru 3'0"	\$58	\$66	\$77	\$91	\$115
	Thru 4'0"	\$75	\$85	\$93	\$107	\$129
	Thru 6'0"	\$118	\$126	\$138	\$153	\$177
	Thru 8'0"	\$143	\$154	\$173	\$187	\$211

NOTES:

1. Jamb Depths:

- 4¹/₂" and larger are double rabbet as standard
- 3¹/₄" thru 4³/₈" are supplied double rabbet with a ⁹/₁₆" rabbet on the non-door side
- All frames listed are available in jamb depth increments of ¹/₈"

2. Door Opening Sizes:

- Standard frame sizes are listed
- Any non-standard frame width and/or height is priced as the next larger size frame category
- Maximum size:
 - Single: 4'0" x 9'0"
 - Double: 8'0" x 9'0"

3. Cased Open Frames:

- Priced as two (2) strike jambs and head from Component Part Pricing
- Weld-in fixed base anchor standard

LABELED FRAMES: (NO CLOSER REINF)	Single	Pair
UL (no closer reinf)		
• Metal label	\$28	\$56
• 3 hr in stud partition (includes stiffeners in head)	\$34	\$68
ITS/WHI (no closer reinf)		
• Metal label	\$28	\$56
• Mylar label	\$21	\$42
• Mylar label smoke & draft	\$21	\$42
FM	N/A	N/A

Refer to the Steelcraft Tech Data Manual for all labeled approvals.

Prices subject to change without notice.

16 GAUGE MULTI-USE FRAMES

FOR 1³/₄" OR 1³/₈" DOORS

MU16-SERIES

FRAMES

Standard Construction Options: Per frame

GALVANNEALED A-60 STEEL:

- Complete frame.....\$53
- Per jamb.....\$20
- Per head.....\$13

GALVANIZED G-90 STEEL:

- Complete frame.....\$99
- Per jamb.....\$37
- Per head.....\$25
- Maximum opening height 9'10"

4" FACE HEAD:	Thru 4'0"	Over 4'0"
	\$57.....	\$81

MARK NUMBERS..... N/C

EQUAL RABBET..... N/C

DUTCH FRAME:	Non-Labeled	Labeled
	\$52.....	\$131

COMMUNICATING FRAMES:

- Single openings only.....\$81
- Specify if doors swing from the same or opposite jambs

SPECIAL PROFILE FRAMES:

- Refer to Custom Frame Options section for pricing
- Special anchor charges will apply

HOSPITAL SANITARY STOPS (4", 5¹/₂" and 6" high standard):

- Single rabbet 45° only.....\$216
- Double rabbet 45°.....\$216
- Double rabbet 90°.....\$216

ANCHORS (Factory welded or prepped):

	Per frame	
	Thru 9 ¹ / ₈ "	Over 9 ¹ / ₈ "
• Welded-in standard anchors (in lieu of loose)		
• Base.....	N/C	N/C
• Jambs thru 7'6".....	\$42.....	\$60
• Jambs over 7'6" thru 10'0".....	\$56.....	\$80
• Each additional.....	\$7.....	\$10
• EMA (pierce and dimple only)		
• Jambs thru 7'1".....	\$44.....	\$88
• Jambs over 7'1" thru 8'9".....	\$55.....	\$110
• Jambs over 8'9" thru 10'0".....	\$66.....	\$132
• Each additional.....	\$5.50.....	\$11
• EMA (pierce, dimple, weld-in anchors with bolts)		
• Jambs thru 7'1".....	\$186.....	\$372
• Jambs over 7'1" thru 8'9".....	\$232.50.....	\$465
• Jambs over 8'9" thru 10'0".....	\$279.....	\$558
• Each additional.....	\$23.25.....	\$46.50

Note – Other EMA configuration pricing available, see custom frame option page

ANCHORS (Standard loose / lock-in):

- Deletion of anchors (deduct from standard frame price)

	Per jamb	Per frame
• Base.....	\$3.25.....	\$6.50
• Jambs thru 7'6".....	\$9.75.....	\$19.50
• Jambs over 7'6".....	\$13.....	\$26

Standard Hardware Options: Per prep

12 GAUGE HEAD REINFORCING CHANNEL:

- (2" face only, full jamb depth).....\$192

SPECIAL VERTICAL HARDWARE LOCATIONS:

- Hinge and lock.....N/C

CLOSERS:

- Surface mounted:
 - 14" strap installed.....\$28
 - (specify regular, parallel arm or top jamb)
 - Closer sleeve installed.....\$58
- Concealed in head (per template).....\$281
- ALLE Concealed in head (per template).....\$254

HINGES:

- 5" Universal in lieu of 4¹/₂".....N/C
- Additional hinge prep (4¹/₂" or 5").....\$21
- High frequency prep.....\$25
- Continuous hinge:
 - No reinf. (blank jamb).....N/C
 - Full length reinf.....\$81

STRIKES:

- Additional ASA (4⁷/₈" ANSI A115.1-2).....\$21
- Additional Cylindrical (2³/₄" ANSI A115.3).....\$21
- (minimum 7" above or below standard strike)
- Double Cylindrical (2³/₄" on 4" centers).....\$42
- Deadlock (non-lip).....\$21
- Flushbolts:
 - Steelcraft reversible.....\$57
 - Standard (ANSI 115.4).....\$57
- Surface Bolt reinf.....\$29
- Exit Devices:
 - Rim reinf. only.....\$29
 - Vertical Rod reinf. only.....\$29
 - Vertical Rod Mortise strike (each).....\$67
- Roller latch (each).....\$43

ELECTRICAL PREPS:

- Power transfer units (i.e. EPT2, EPT10, etc.).....\$133
- Electric hinge prep.....\$53
- Electric strike prep.....\$98
- Door position switch (1/2" to 1" dia.).....\$53
- Magnetic switch (rectangular and mortised).....\$119

NOTE:

1. Electric preps come standard with mortar guards on standard profile products, including knock-outs.

Prices subject to change without notice.

COMPLETE FRAME PRICING

Single Frame		JAMB DEPTH				
Width	Height	3 ¹ / ₄ "-5 ⁷ / ₈ "	6"-7 ⁷ / ₈ "	8"-9 ⁷ / ₈ "	10"-11 ⁷ / ₈ "	12"-14 ³ / ₄ "
1'6" thru 3'0"	6' 8"	\$391	\$416	\$464	\$520	\$606
	7' 0"	\$407	\$435	\$478	\$531	\$624
	7'2"	\$420	\$453	\$494	\$551	\$643
	8' 0"	\$485	\$506	\$550	\$610	\$701
Over 3'0" thru 4'0"	9'0"	\$538	\$570	\$614	\$680	\$786
	6' 8"	\$398	\$428	\$476	\$537	\$616
	7' 0"	\$414	\$447	\$490	\$548	\$634
	7'2"	\$427	\$465	\$506	\$568	\$653
	8' 0"	\$492	\$518	\$562	\$627	\$711
9'0"	\$545	\$582	\$626	\$697	\$796	

Double Frame		JAMB DEPTH				
Width	Height	3 ¹ / ₄ "-5 ⁷ / ₈ "	6"-7 ⁷ / ₈ "	8"-9 ⁷ / ₈ "	10"-11 ⁷ / ₈ "	12"-14 ³ / ₄ "
4'0" thru 6'0"	6' 8"	\$464	\$494	\$542	\$605	\$687
	7' 0"	\$488	\$512	\$558	\$611	\$701
	7'2"	\$496	\$538	\$582	\$641	\$733
	8' 0"	\$578	\$602	\$648	\$711	\$801
	9'0"	\$640	\$666	\$714	\$783	\$889
Over 6'0" thru 8'0"	6' 8"	\$493	\$525	\$576	\$645	\$726
	7' 0"	\$517	\$543	\$592	\$651	\$740
	7'2"	\$525	\$569	\$616	\$681	\$772
	8' 0"	\$607	\$633	\$682	\$751	\$840
	9'0"	\$669	\$697	\$748	\$823	\$928

COMPONENT PART PRICING

JAMB DEPTH						
Part	Height	3 ¹ / ₄ "-5 ⁷ / ₈ "	6"-7 ⁷ / ₈ "	8"-9 ⁷ / ₈ "	10"-11 ⁷ / ₈ "	12"-14 ³ / ₄ "
Strike Jamb	6' 8"	\$148	\$159	\$173	\$191	\$220
	7' 0"	\$152	\$169	\$179	\$199	\$231
	7'2"	\$161	\$174	\$183	\$204	\$234
	8' 0"	\$185	\$195	\$206	\$228	\$258
	9'0"	\$207	\$227	\$237	\$262	\$299
Hinge Jamb	6' 8"	\$160	\$170	\$187	\$210	\$237
	7' 0"	\$172	\$179	\$195	\$213	\$244
	7'2"	\$176	\$192	\$207	\$228	\$260
	8' 0"	\$217	\$224	\$240	\$263	\$294
	9'0"	\$248	\$256	\$273	\$299	\$338
JAMB DEPTH						
Part	Width	3 ¹ / ₄ "-5 ⁷ / ₈ "	6"-7 ⁷ / ₈ "	8"-9 ⁷ / ₈ "	10"-11 ⁷ / ₈ "	12"-14 ³ / ₄ "
Head	Thru 3'0"	\$83	\$87	\$104	\$119	\$149
	Thru 4'0"	\$90	\$99	\$116	\$136	\$159
	Thru 6'0"	\$144	\$154	\$168	\$185	\$213
	Thru 8'0"	\$173	\$185	\$202	\$225	\$252

NOTES:

1. Jamb Depths:

- 4¹/₂" and larger are double rabbet as standard
- 3¹/₄" thru 4³/₈" are supplied double rabbet with a ⁹/₁₆" rabbet on the non-door side
- All frames listed are available in jamb depth increments of ¹/₈"

2. Door Opening Sizes:

- Standard frame sizes are listed
- Any non-standard frame width and/or height is priced as the next larger size frame category
- Maximum size:
 - Single: 4'0" x 9'0"
 - Double: 8'0" x 9'0"

3. Cased Open Frames:

- Priced as two (2) strike jambs and head from Component Part Pricing
- Weld-in fixed base anchor standard

LABELED FRAMES: (NO CLOSER REINF)	Single	Pair
UL (no closer reinf)		
• Metal label	\$28	\$56
• 3 hr in stud partition (includes stiffeners in head)	\$34	\$68
ITS/WHI (no closer reinf)		
• Metal label	\$28	\$56
• Mylar label	\$21	\$42
• Mylar label smoke & draft	\$21	\$42
FM	N/A	N/A

Refer to the Steelcraft Tech Data Manual for all labeled approvals.

Prices subject to change without notice.

14 GAUGE MULTI-USE FRAMES

FOR 1³/₄" DOORS

MU14-SERIES

FRAMES

Standard Construction Options: Per frame

GALVANNEALED A-60 STEEL:

- Complete frame \$53
- Per jamb \$20
- Per head \$13

GALVANIZED G-90 STEEL:

- Complete frame \$99
- Per jamb \$37
- Per head \$25
- Maximum opening height 9'10"

4" FACE HEAD:	Thru 4'0"	Over 4'0"
	\$57	\$81

MARK NUMBERS N/C

EQUAL RABBET N/C

DUTCH FRAME:	Non-Labeled	Labeled
	\$52	\$131

COMMUNICATING FRAMES:

- Single openings only \$81
- Specify if doors swing from the same or opposite jambs

SPECIAL PROFILE FRAMES:

- Refer to Custom Frame Options section for pricing
- Special anchor charges will apply

HOSPITAL SANITARY STOPS (4", 5¹/₂" and 6" high standard):

- Single rabbet 45° only \$216
- Double rabbet 45° \$216
- Double rabbet 90° \$216

ANCHORS (Factory welded or prepped):

	Per frame	
	Thru 9 ¹ / ₈ "	Over 9 ¹ / ₈ "
• Welded-in standard anchors (in lieu of loose)		
• Base	N/C	N/C
• Jambs thru 7'6"	\$42	\$60
• Jambs over 7'6" thru 10'0"	\$56	\$80
• Each additional	\$7	\$10
• EMA (pierce and dimple only)		
• Jambs thru 7'1"	\$44	\$88
• Jambs over 7'1" thru 8'9"	\$55	\$110
• Jambs over 8'9" thru 10'0"	\$66	\$132
• Each additional	\$5.50	\$11
• EMA (pierce, dimple, weld-in anchors with bolts)		
• Jambs thru 7'1"	\$186	\$372
• Jambs over 7'1" thru 8'9"	\$232.50	\$465
• Jambs over 8'9" thru 10'0"	\$279	\$558
• Each additional	\$23.25	\$46.50

Note – Other EMA configuration pricing available, see custom frame option page

ANCHORS (Standard loose / lock-in):

• Deletion of anchors (deduct from standard frame price)

	Per jamb	Per frame
• Base	\$3.25	\$6.50
• Jambs thru 7'6"	\$9.75	\$19.50
• Jambs over 7'6"	\$13	\$26

Standard Hardware Options: Per prep

12 GAUGE HEAD REINFORCING CHANNEL:

- (2" face only, full jamb depth) \$192

SPECIAL VERTICAL HARDWARE LOCATIONS:

- Hinge and lock N/C

CLOSERS:

- Surface mounted:
 - 14" strap installed \$28
 - (specify regular, parallel arm or top jamb)
 - Closer sleeve installed \$58
- Concealed in head (per template) \$281
- ALLE Concealed in head (per template) \$254

HINGES:

- 5" Universal in lieu of 4¹/₂" N/C
- Additional hinge prep (4¹/₂" or 5") \$21
- High frequency prep \$25
- Continuous hinge:
 - No reinf. (blank jamb) N/C
 - Full length reinf. \$81

STRIKES:

- Additional ASA (4⁷/₈" ANSI A115.1-2) \$21
- Additional Cylindrical (2³/₄" ANSI A115.3) \$21
- (minimum 7" above or below standard strike)
- Double Cylindrical (2³/₄" on 4" centers) \$42
- Deadlock (non-lip) \$21
- Flushbolts:
 - Steelcraft reversible \$57
 - Standard (ANSI 115.4) \$57
- Surface Bolt reinf. \$29
- Exit Devices:
 - Rim reinf. only \$29
 - Vertical Rod reinf. only \$29
 - Vertical Rod Mortise strike (each) \$67
- Roller latch (each) \$43

ELECTRICAL PREPS:

- Power transfer units (i.e. EPT2, EPT10, etc.) \$133
- Electric hinge prep \$53
- Electric strike prep \$98
- Door position switch (1/2" to 1" dia.) \$53
- Magnetic switch (rectangular and mortised) \$119

NOTE:

1. Electric preps come standard with mortar guards on standard profile products, including knock-outs.

Prices subject to change without notice.

FE16 / DE16 COMPLETE FRAME PRICING						
JAMB DEPTH						
Width	Height	4 ³ / ₄ "-5 ⁷ / ₈ "	6"-7 ⁷ / ₈ "	8"-9 ⁷ / ₈ "	10"-11 ⁷ / ₈ "	12"-14"
5'0" thru 6'0"	6' 8"	\$919	\$949	\$980	\$1,047	\$1,146
	7' 0"	\$925	\$951	\$988	\$1,057	\$1,154
	7'2"	\$955	\$977	\$1,012	\$1,077	\$1,176
	8' 0"	\$1,017	\$1,041	\$1,072	\$1,141	\$1,246
	9'0"	\$1,043	\$1,077	\$1,104	\$1,165	\$1,280
Over 6'0" thru 8'0"	10' 0"	\$1,087	\$1,115	\$1,154	\$1,225	\$1,336
	6' 8"	\$952	\$982	\$1,016	\$1,082	\$1,181
	7' 0"	\$958	\$984	\$1,024	\$1,092	\$1,189
	7'2"	\$988	\$1,010	\$1,048	\$1,112	\$1,211
	8' 0"	\$1,050	\$1,074	\$1,108	\$1,176	\$1,281
9'0"	\$1,076	\$1,110	\$1,140	\$1,200	\$1,315	
10' 0"	\$1,120	\$1,148	\$1,190	\$1,260	\$1,371	

FE16 / DE16 COMPONENT PART PRICING						
JAMB DEPTH						
Part	Height	4 ³ / ₄ "-5 ⁷ / ₈ "	6"-7 ⁷ / ₈ "	8"-9 ⁷ / ₈ "	10"-11 ⁷ / ₈ "	12"-14"
Hinge Jamb	6' 8"	\$303	\$314	\$324	\$346	\$379
	7' 0"	\$306	\$315	\$328	\$351	\$383
	7'2"	\$321	\$328	\$340	\$361	\$394
	8' 0"	\$352	\$360	\$370	\$393	\$429
	9'0"	\$365	\$378	\$386	\$405	\$446
	10' 0"	\$387	\$397	\$411	\$435	\$474
JAMB DEPTH						
Part	Height	4 ³ / ₄ "-5 ⁷ / ₈ "	6"-7 ⁷ / ₈ "	8"-9 ⁷ / ₈ "	10"-11 ⁷ / ₈ "	12"-14"
Head	Thru 6'0"	\$313	\$321	\$332	\$355	\$388
	Thru 8'0"	\$346	\$354	\$368	\$390	\$423

FE14 / DE14 COMPLETE FRAME PRICING						
JAMB DEPTH						
Width	Height	4 ³ / ₄ "-5 ⁷ / ₈ "	6"-7 ⁷ / ₈ "	8"-9 ⁷ / ₈ "	10"-11 ⁷ / ₈ "	12"-14"
5'0" thru 6'0"	6' 8"	\$1,003	\$1,021	\$1,062	\$1,148	\$1,236
	7' 0"	\$1,017	\$1,039	\$1,084	\$1,158	\$1,258
	7'2"	\$1,039	\$1,045	\$1,094	\$1,164	\$1,270
	8' 0"	\$1,115	\$1,129	\$1,172	\$1,244	\$1,362
	9'0"	\$1,133	\$1,173	\$1,204	\$1,272	\$1,390
Over 6'0" thru 8'0"	10' 0"	\$1,179	\$1,205	\$1,250	\$1,338	\$1,454
	6' 8"	\$1,029	\$1,056	\$1,097	\$1,182	\$1,278
	7' 0"	\$1,043	\$1,074	\$1,119	\$1,192	\$1,300
	7'2"	\$1,065	\$1,080	\$1,129	\$1,198	\$1,312
	8' 0"	\$1,141	\$1,164	\$1,207	\$1,278	\$1,404
9'0"	\$1,159	\$1,208	\$1,239	\$1,306	\$1,432	
10' 0"	\$1,205	\$1,240	\$1,285	\$1,372	\$1,496	

FE14 / DE14 COMPONENT PART PRICING						
JAMB DEPTH						
Part	Height	4 ³ / ₄ "-5 ⁷ / ₈ "	6"-7 ⁷ / ₈ "	8"-9 ⁷ / ₈ "	10"-11 ⁷ / ₈ "	12"-14"
Hinge Jamb	6' 8"	\$328	\$336	\$349	\$379	\$408
	7' 0"	\$335	\$345	\$360	\$384	\$419
	7'2"	\$346	\$348	\$365	\$387	\$425
	8' 0"	\$384	\$390	\$404	\$427	\$471
	9'0"	\$393	\$412	\$420	\$441	\$485
	10' 0"	\$416	\$428	\$443	\$474	\$517
JAMB DEPTH						
Part	Width	4 ³ / ₄ "-5 ⁷ / ₈ "	6"-7 ⁷ / ₈ "	8"-9 ⁷ / ₈ "	10"-11 ⁷ / ₈ "	12"-14"
Head	Thru 6'0"	\$347	\$349	\$364	\$390	\$420
	Thru 8'0"	\$373	\$384	\$399	\$424	\$462

NOTES:

1. Jamb Depths and Profiles:

- Right hand FE and DE frames are standard
- Minimum non-labeled jamb depth is 4³/₄", 5³/₄" for DE
- Minimum labeled jamb depth is 5³/₄"
- All frames listed are available in jamb depth increments of 1/8"

2. Door Opening Sizes:

- Standard frame sizes are listed
- Any non-standard frame width and/or height is priced as the next larger size frame category
- Maximum size:
 - Double: 8'0" x 10'0"

3. Frame Head Components:

- FE and DE heads are 1/8" undersized in door opening width

4. Double Egress Hinging Applications:

- **FE Series frames** are designed for use with conventional butt hinges. For pocket pivot and swing clear hinging applications special profile and special anchoring charges are applicable
- **DE-Series frames** are designed for use with pocket pivot and/or swing clear hinging applications
 - Must be welded

LABELLED FRAMES: (NO CLOSER REINF)	Pair
UL (no closer reinf) • Metal label	\$56
ITS/WHI (no closer reinf) • Metal label • Mylar label smoke & draft	\$56 \$42
FM	N/A

Refer to the Steelcraft Tech Data Manual for all labeled approvals.

Prices subject to change without notice.

16 AND 14 GAUGE DOUBLE EGRESS FRAMES FOR 1³/₄" DOORS

FE and DE-SERIES **FRAMES**

Standard Construction Options: Per frame

GALVANNEALED A-60 STEEL:

- Complete frame \$53
- Per jamb \$20
- Per head \$13

GALVANIZED G-90 STEEL:

- Complete frame \$99
- Per jamb \$37
- Per head \$25
- Maximum opening height 9'10"

4" FACE HEAD: **Over 4'0"**

\$81

MARK NUMBERS N/C

SPECIAL PROFILE FRAMES:

- Refer to Custom Frame Options section for pricing
- Special anchor charges will apply

HOSPITAL SANITARY STOPS not available

ANCHORS (Factory welded or prepped):

	Per frame	
	Thru 9 ¹ / ₈ "	Over 9 ¹ / ₈ "
• Welded-in standard anchors (in lieu of loose)		
• Base	N/C	N/C
• Jambs thru 7'6"	\$42	\$60
• Jambs over 7'6" thru 10'0"	\$56	\$80
• Each additional	\$7	\$10
• EMA (pierce and dimple only)		
• Jambs thru 7'1"	\$44	\$88
• Jambs over 7'1" thru 8'9"	\$55	\$110
• Jambs over 8'9" thru 10'0"	\$66	\$132
• Each additional	\$5.50	\$11
• EMA (pierce, dimple, weld-in anchors with bolts)		
• Jambs thru 7'1"	\$186	\$372
• Jambs over 7'1" thru 8'9"	\$232.50	\$465
• Jambs over 8'9" thru 10'0"	\$279	\$558
• Each additional	\$23.25	\$46.50

Note – Other EMA configuration pricing available, see custom frame option page

ANCHORS (Standard loose, wire masonry):

• Deletion of anchors (deduct from standard frame price)

	Per jamb	Per frame
• Base	\$3.25	\$6.50
• Jambs thru 7'6"	\$9.75	\$19.50
• Jambs over 7'6"	\$13	\$26

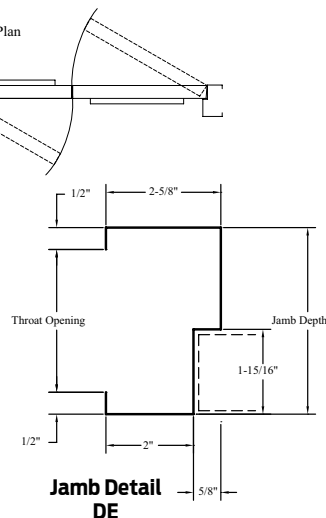
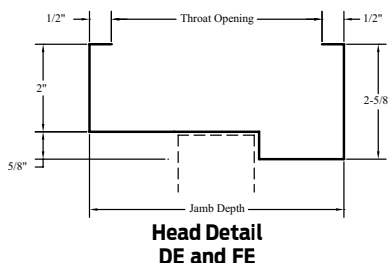
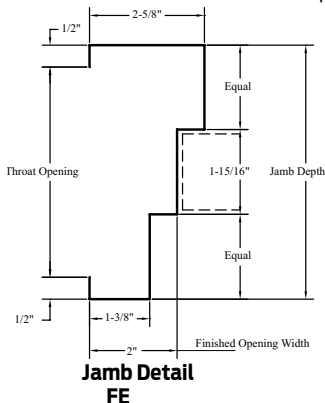

Standard Hardware Options: Per prep

12 GAUGE HEAD REINFORCING CHANNEL:

(2" face only, full jamb depth) \$192

SPECIAL VERTICAL HARDWARE LOCATIONS:

- Hinge and lock N/C

CLOSERS:

- Surface mounted
- 14" strap installed \$28
(specify regular, parallel arm or top jamb)
- Concealed in head (per template) \$281
- ALLE Concealed in head (per template) \$254
(masonry or non-label only)

HINGES:

- 5" Universal in lieu of 4 1/2" N/C
- Additional hinge prep (4 1/2" or 5") \$21
- High frequency prep \$25
- Continuous hinge:
- No reinf. (blank Jamb) N/C
- Full length reinf. \$81

STRIKES:

- Exit Devices:
- Vertical Rod reinf. only \$29
- Vertical Rod Mortised strike (each) \$67

ELECTRICAL PREPS:

- Power transfer units (i.e. EPT2, EPT10, etc.) \$133
- Electric hinge prep \$53
- Electric strike prep \$98
- Door position switch (1/2" to 1" dia.) \$53
- Magnetic switch (rectangular and mortised) \$119

NOTE:

1. Electric preps come standard with mortar guards. Standard profile guards will have knock-outs included.
2. Electric preps come standard with mortar guards on standard profile products, including knock-outs.

Prices subject to change without notice.

16 GAUGE DRYWALL FRAMES

FOR 1³/₈" OR 1³/₄" DOORS

COMPLETE FRAME PRICING

Single Frame		JAMB DEPTH				
Width	Height	3 ¹ / ₄ "-5 ⁷ / ₈ "	6"-7 ⁷ / ₈ "	8"-9 ⁷ / ₈ "	10"-11 ⁷ / ₈ "	12"-14 ³ / ₄ "
1'6" thru 3'0"	6' 8"	\$298	\$347	\$381	\$428	\$506
	7' 0"	\$319	\$363	\$395	\$445	\$526
	7'2"	\$335	\$379	\$413	\$465	\$551
	8' 0"	\$376	\$424	\$457	\$508	\$599
Over 3'0" thru 4'0"	9'0"	\$426	\$487	\$518	\$570	\$673
	6' 8"	\$313	\$362	\$392	\$444	\$517
	7' 0"	\$334	\$378	\$406	\$461	\$537
	7'2"	\$350	\$394	\$424	\$481	\$562
	8' 0"	\$391	\$439	\$468	\$524	\$610
9'0"	\$441	\$502	\$529	\$586	\$684	

Double Frame		JAMB DEPTH				
Width	Height	3 ¹ / ₄ "-5 ⁷ / ₈ "	6"-7 ⁷ / ₈ "	8"-9 ⁷ / ₈ "	10"-11 ⁷ / ₈ "	12"-14 ³ / ₄ "
4'0" thru 6'0"	6' 8"	\$361	\$409	\$448	\$493	\$570
	7' 0"	\$379	\$419	\$464	\$507	\$592
	7'2"	\$397	\$441	\$480	\$531	\$624
	8' 0"	\$449	\$495	\$536	\$589	\$672
	9'0"	\$505	\$561	\$598	\$651	\$752
Over 6'0" thru 8'0"	6' 8"	\$382	\$433	\$472	\$520	\$600
	7' 0"	\$400	\$443	\$488	\$534	\$622
	7'2"	\$418	\$465	\$504	\$558	\$654
	8' 0"	\$470	\$519	\$560	\$616	\$702
	9'0"	\$526	\$585	\$622	\$678	\$782

COMPONENT PART PRICING

JAMB DEPTH						
Part	Height	3 ¹ / ₄ "-5 ⁷ / ₈ "	6"-7 ⁷ / ₈ "	8"-9 ⁷ / ₈ "	10"-11 ⁷ / ₈ "	12"-14 ³ / ₄ "
Strike Jamb	6' 8"	\$116	\$129	\$139	\$158	\$184
	7' 0"	\$128	\$140	\$145	\$168	\$193
	7'2"	\$135	\$145	\$155	\$176	\$202
	8' 0"	\$150	\$163	\$171	\$190	\$226
	9'0"	\$172	\$193	\$201	\$221	\$260
Hinge Jamb	6' 8"	\$127	\$147	\$160	\$176	\$203
	7' 0"	\$136	\$152	\$168	\$183	\$214
	7'2"	\$145	\$163	\$176	\$195	\$230
	8' 0"	\$171	\$190	\$204	\$224	\$254
	9'0"	\$199	\$223	\$235	\$255	\$294
JAMB DEPTH						
Part	Width	3 ¹ / ₄ "-5 ⁷ / ₈ "	6"-7 ⁷ / ₈ "	8"-9 ⁷ / ₈ "	10"-11 ⁷ / ₈ "	12"-14 ³ / ₄ "
Head	Thru 3'0"	\$55	\$71	\$82	\$94	\$119
	Thru 4'0"	\$70	\$86	\$93	\$110	\$130
	Thru 6'0"	\$107	\$115	\$128	\$141	\$164
	Thru 8'0"	\$128	\$139	\$152	\$168	\$194

NOTES:

1. Jamb Depths:

- 4¹/₂" and larger are double rabbet as standard
- 3¹/₄" thru 4³/₈" are supplied double rabbet with a ⁹/₁₆" rabbet on the non-door side
- All frames listed are available in jamb depth increments of ¹/₈"

2. Door Opening Sizes:

- Standard frame sizes are listed
- Any non-standard frame width and/or height is priced as the next larger size frame category
- Maximum size:
 - Single: 4'0" x 9'0"
 - Double: 8'0" x 9'0"

3. Anchors:

- Frame prices include one (1) adjustable compression anchor in each jamb
- Jamb depths over 9¹/₈" include two (2) compression anchors per jamb
- DW-Series frames include two (2) twist-in base anchors per jamb
- K-Series frames have a countersunk hole in the face of each jamb near the base for fastening to the floor runner (screws not included)

4. Cased Open Frames:

- Priced as two (2) strike jambs and head from Component Part Pricing

LABELED FRAMES: (NO CLOSER REINF)	Single	Pair
UL (no closer reinf)		
- Metal label	\$28	\$56
ITS/WHI (no closer reinf)		
- Metal label	\$28	\$56
- Mylar label	\$21	\$42
- Mylar label smoke & draft	\$21	\$42
FM (no closer reinf)		
- Mylar label	\$21	\$42

Refer to the Steelcraft Tech Data Manual for all labeled approvals.

Prices subject to change without notice.

16 GAUGE DRYWALL FRAMES

FOR 1³/₄" OR 1³/₈" DOORS

DW16 and K16-SERIES

FRAMES

Standard Construction Options: Per frame

GALVANNEALED A-60 STEEL:

- Complete frame \$53
- Per jamb \$20
- Per head \$13

GALVANIZED G-90 STEEL:

- Complete frame \$99
- Per jamb \$37
- Per head \$25
- Maximum opening height 9'10"

4" FACE HEAD:	Thru 4'0"	Over 4'0"
	\$57	\$81

MARK NUMBERS N/C

EQUAL RABBET N/C

DUTCH FRAME:

- Non-Labeled only \$52

COMMUNICATING FRAMES:

- Single openings only \$81
- Doors must swing from opposite jambs

SPECIAL PROFILE FRAMES:

- Refer to Custom Frame Options section for pricing

HOSPITAL SANITARY STOPS (4", 5¹/₂" and 6" high standard):

- Double rabbet 45° \$216
- Double rabbet 90° \$216

ANCHORS:

- DW-Series with twist-in base anchors N/C
- K-Series with visible exposed base anchor preps N/C
- Deletion of anchors (deduct from standard frame price)

	Per jamb	Per frame
• DW-Series base	\$3.25	\$6.50

Standard Hardware Options: Per prep

SPECIAL VERTICAL HARDWARE LOCATIONS:

- Hinge and lock N/C

CLOSERS:

- Surface mounted:
 - 14" strap installed \$28
(specify regular, parallel arm or top jamb)
 - Closer sleeve installed \$58
- Concealed in head (per template) \$281
- ALLE Concealed in head (per template) \$254

HINGES:

- 5" standard or heavy weight in lieu of 4¹/₂" N/C
- 4¹/₂" or 5" Universal in lieu of standard weight N/C
- Additional hinge prep (4¹/₂" or 5") \$21
- High frequency prep \$25
- Continuous hinge:
 - No reinf. (blank Jamb) N/C
 - Full length reinf. \$81

STRIKES:

- Additional ASA (4⁷/₈" ANSI A115.1-2) \$21
- Additional Cylindrical (2⁷/₄" ANSI A115.3) \$21
(minimum 7" above or below standard strike)
- Double Cylindrical (2⁷/₄" on 4" centers) \$42
- Deadlock (non-lip) \$21
- Flushbolts:
 - Steelcraft reversible \$57
 - Standard (ANSI 115.4) \$57
- Surface Bolt reinf. \$29
- Exit Devices:
 - Rim reinf. only \$29
 - Vertical Rod reinf. only \$29
 - Vertical Rod Mortise strike (each) \$67
- Roller latch (each) \$43

ELECTRICAL PREPS:

- Power transfer units (i.e. EPT2, EPT10, etc.) \$133
- Electric hinge prep \$53
- Electric strike prep \$98
- Door position switch (1¹/₂" to 1" dia.) \$52
- Magnetic switch (rectangular and mortised) \$119

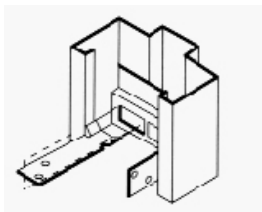

DW Base Anchor

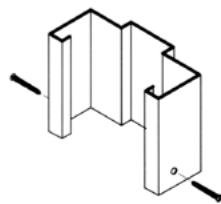

K Base Anchor

12 GAUGE HEAD REINFORCING CHANNEL not available

Prices subject to change without notice.

COMPLETE FRAME PRICING

Single Frame		JAMB DEPTH				
Width	Height	3 ¹ / ₄ "-5 ⁷ / ₈ "	6"-7 ⁷ / ₈ "	8"-9 ⁷ / ₈ "	10"-11 ⁷ / ₈ "	12"-14 ³ / ₄ "
1'6" thru 3'0"	6' 8"	\$381	\$435	\$469	\$530	\$626
	7' 0"	\$404	\$450	\$487	\$548	\$643
	7' 2"	\$412	\$467	\$503	\$563	\$670
	8' 0"	\$468	\$508	\$553	\$603	\$701
Over 3'0" thru 4'0"	9'0"	\$521	\$577	\$620	\$685	\$795
	6' 8"	\$388	\$449	\$478	\$549	\$634
	7' 0"	\$411	\$464	\$496	\$567	\$651
	7' 2"	\$419	\$481	\$512	\$582	\$678
	8' 0"	\$475	\$522	\$562	\$622	\$709
9'0"	\$528	\$591	\$629	\$704	\$803	

Double Frame		JAMB DEPTH				
Width	Height	3 ¹ / ₄ "-5 ⁷ / ₈ "	6"-7 ⁷ / ₈ "	8"-9 ⁷ / ₈ "	10"-11 ⁷ / ₈ "	12"-14 ³ / ₄ "
4'0" thru 6'0"	6' 8"	\$461	\$525	\$545	\$612	\$700
	7' 0"	\$483	\$533	\$565	\$630	\$716
	7' 2"	\$495	\$555	\$583	\$652	\$746
	8' 0"	\$557	\$609	\$651	\$700	\$786
	9'0"	\$623	\$693	\$733	\$810	\$910
Over 6'0" thru 8'0"	6' 8"	\$491	\$556	\$577	\$642	\$739
	7' 0"	\$513	\$564	\$597	\$660	\$755
	7' 2"	\$525	\$586	\$615	\$682	\$785
	8' 0"	\$587	\$640	\$683	\$730	\$825
	9'0"	\$653	\$724	\$765	\$840	\$949

COMPONENT PART PRICING

JAMB DEPTH						
Part	Height	3 ¹ / ₄ "-5 ⁷ / ₈ "	6"-7 ⁷ / ₈ "	8"-9 ⁷ / ₈ "	10"-11 ⁷ / ₈ "	12"-14 ³ / ₄ "
Strike Jamb	6' 8"	\$142	\$160	\$178	\$202	\$236
	7' 0"	\$154	\$171	\$186	\$211	\$245
	7' 2"	\$156	\$177	\$193	\$215	\$257
	8' 0"	\$181	\$191	\$209	\$231	\$268
	9'0"	\$201	\$218	\$235	\$258	\$300
Hinge Jamb	6' 8"	\$160	\$187	\$193	\$218	\$253
	7' 0"	\$171	\$191	\$203	\$227	\$261
	7' 2"	\$177	\$202	\$212	\$238	\$276
	8' 0"	\$208	\$229	\$246	\$262	\$296
	9'0"	\$241	\$271	\$287	\$317	\$358
JAMB DEPTH						
Part	Width	3 ¹ / ₄ "-5 ⁷ / ₈ "	6"-7 ⁷ / ₈ "	8"-9 ⁷ / ₈ "	10"-11 ⁷ / ₈ "	12"-14 ³ / ₄ "
Head	Thru 3'0"	\$79	\$88	\$98	\$110	\$137
	Thru 4'0"	\$86	\$102	\$107	\$129	\$145
	Thru 6'0"	\$141	\$151	\$159	\$176	\$194
	Thru 8'0"	\$171	\$182	\$191	\$206	\$233

NOTES:

1. Jamb Depths:

- 4¹/₂" and larger are double rabbet as standard
- 3¹/₄" thru 4³/₈" are supplied double rabbet with a ⁹/₁₆" rabbet on the non-door side
- All frames listed are available in jamb depth increments of ¹/₈"

2. Door Opening Sizes:

- Standard frame sizes are listed
- Any non-standard frame width and/or height is priced as the next larger size frame category
- Maximum size:
 - Single: 4'0" x 9'0"
 - Double: 8'0" x 9'0"

3. Anchors:

- Frame prices include one (1) adjustable compression anchor in each jamb
- Jamb depths over 9¹/₈" include two (2) compression anchors per jamb
- DW-Series frames include two (2) twist-in base anchors per jamb
- K-Series frames have a countersunk hole in the face of each jamb near the base for fastening to the floor runner (screws not included)

4. Cased Open Frames:

- Priced as two (2) strike jambs and head from Component Part Pricing

LABELED FRAMES: (NO CLOSER REINF)	Single	Pair
UL (no closer reinf)		
- Metal label	\$28	\$56
ITS/WHI (no closer reinf)		
- Metal label	\$28	\$56
- Mylar label	\$21	\$42
- Mylar label smoke & draft	\$21	\$42
FM (no closer reinf)		
- Mylar label	\$21	\$42

Refer to the Steelcraft Tech Data Manual for all labeled approvals.

Prices subject to change without notice.

14 GAUGE DRYWALL FRAMES FOR 1³/₄" DOORS

DW14 and K14-SERIES

FRAMES

Standard Construction Options: Per frame

GALVANNEALED A-60 STEEL:

- Complete frame.....\$53
- Per jamb.....\$20
- Per head.....\$13

GALVANIZED G-90 STEEL:

- Complete frame.....\$99
- Per jamb.....\$37
- Per head.....\$25
- Maximum opening height 9'10"

4" FACE HEAD:	Thru 4'0"	Over 4'0"
	\$57.....	\$81

MARK NUMBERSN/C

EQUAL RABBETN/C

DUTCH FRAME:

- Non-Labeled only\$52

COMMUNICATING FRAMES:

- Single openings only\$81
- Doors must swing from opposite jambs

SPECIAL PROFILE FRAMES:

- Refer to Custom Frame Options section for pricing

HOSPITAL SANITARY STOPS (4", 5¹/₂" and 6" high standard):

- Double rabbet 45°.....\$216
- Double rabbet 90°.....\$216

ANCHORS:

- DW-Series with twist-in base anchors.....N/C
- K-Series with visible exposed base anchor preps.....N/C
- Deletion of anchors (deduct from standard frame price)

	Per jamb	Per frame
• DW-Series base.....	\$3.25	\$6.50

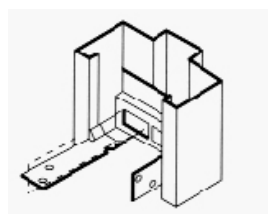

DW Base Anchor

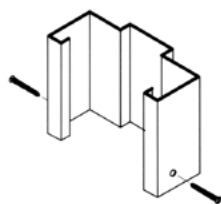

K Base Anchor

12 GAUGE HEAD REINFORCING CHANNEL not available

Standard Hardware Options: Per prep

SPECIAL VERTICAL HARDWARE LOCATIONS:

- Hinge and lockN/C

CLOSERS:

- Surface mounted:
 - 14" strap installed.....\$28
(specify regular, parallel arm or top jamb)
 - Closer sleeve installed.....\$58
- Concealed in head (per template).....\$281
- ALLE Concealed in head (per template).....\$254

HINGES:

- 5" standard or heavy weight in lieu of 4¹/₂".....N/C
- 4¹/₂" or 5" Universal in lieu of standard weight.....N/C
- Additional hinge prep (4¹/₂" or 5").....\$21
- High frequency prep.....\$25
- Continuous hinge:
 - No reinf. (blank Jamb).....N/C
 - Full length reinf.\$81

STRIKES:

- Additional ASA (4⁷/₈" ANSI A115.1-2).....\$21
- Additional Cylindrical (2¹/₄" ANSI A115.3).....\$21
(minimum 7" above or below standard strike)
- Double Cylindrical (2¹/₄" on 4" centers).....\$42
- Deadlock (non-lip).....\$21

Flushbolts:

- Steelcraft reversible.....\$57
- Standard (ANSI 115.4).....\$57
- Surface Bolt reinf.\$29

Exit Devices:

- Rim reinf. only.....\$29
- Vertical Rod reinf. only.....\$29
- Vertical Rod Mortise strike (each).....\$67
- Roller latch (each).....\$43

ELECTRICAL PREPS:

- Power transfer units (i.e. EPT2, EPT10, etc.).....\$133
- Electric hinge prep.....\$53
- Electric strike prep.....\$98
- Door position switch (1¹/₂" to 1" dia.).....\$53
- Magnetic switch (rectangular and mortised).....\$119

Prices subject to change without notice.

STAINLESS STEEL FRAMES 16 GA

FINISH: #4 BRUSHED SATIN OR 2B MILL, FOR 1-3/4" DOORS

FS, MS, KS - SERIES **FRAMES**

WELDED FRAMES AND KD FRAMES

3 Sided Frame 304 Alloy		JAMB DEPTH						
Width	Height	up to 6	over 6 - up to 7	over 7 up to 8	over 8 up to 9	over 9 up to 10	over 10 up to 11	over 11 up to 12
3' 0"	7' 0"	\$1,250	\$1,320	\$1,390	\$1,460	\$1,530	\$1,590	\$1,660
3' 0"	8' 0"	\$1,350	\$1,420	\$1,490	\$1,560	\$1,630	\$1,690	\$1,760
4' 0"	7' 0"	\$1,350	\$1,420	\$1,490	\$1,560	\$1,630	\$1,690	\$1,760
4' 0"	8' 0"	\$1,450	\$1,520	\$1,590	\$1,660	\$1,730	\$1,790	\$1,860
5' 0"	7' 0"	\$1,500	\$1,570	\$1,640	\$1,710	\$1,780	\$1,840	\$1,910
5' 0"	8' 0"	\$1,600	\$1,670	\$1,740	\$1,810	\$1,880	\$1,940	\$2,010
6' 0"	7' 0"	\$1,500	\$1,570	\$1,640	\$1,710	\$1,780	\$1,840	\$1,910
6' 0"	8' 0"	\$1,600	\$1,670	\$1,740	\$1,810	\$1,880	\$1,940	\$2,010
7' 0"	7' 0"	\$1,560	\$1,630	\$1,700	\$1,770	\$1,840	\$1,900	\$1,970
7' 0"	8' 0"	\$1,660	\$1,730	\$1,800	\$1,870	\$1,940	\$2,000	\$2,070
8' 0"	7' 0"	\$1,640	\$1,710	\$1,780	\$1,850	\$1,920	\$1,980	\$2,050
8' 0"	8' 0"	\$1,740	\$1,810	\$1,880	\$1,950	\$2,020	\$2,080	\$2,150

3 Sided Frame 316 Alloy		JAMB DEPTH						
Width	Height	up to 6	over 6 - up to 7	over 7 up to 8	over 8 up to 9	over 9 up to 10	over 10 up to 11	over 11 up to 12
3' 0"	7' 0"	\$1,630	\$1,720	\$1,810	\$1,890	\$1,980	\$2,070	\$2,160
3' 0"	8' 0"	\$1,760	\$1,850	\$1,940	\$2,020	\$2,110	\$2,200	\$2,290
4' 0"	7' 0"	\$1,750	\$1,840	\$1,930	\$2,010	\$2,100	\$2,190	\$2,280
4' 0"	8' 0"	\$1,890	\$1,980	\$2,070	\$2,150	\$2,240	\$2,330	\$2,420
5' 0"	7' 0"	\$1,930	\$2,020	\$2,110	\$2,190	\$2,280	\$2,370	\$2,460
5' 0"	8' 0"	\$2,060	\$2,150	\$2,240	\$2,320	\$2,410	\$2,500	\$2,590
6' 0"	7' 0"	\$1,930	\$2,020	\$2,110	\$2,190	\$2,280	\$2,370	\$2,460
6' 0"	8' 0"	\$2,060	\$2,150	\$2,240	\$2,320	\$2,410	\$2,500	\$2,590
7' 0"	7' 0"	\$2,010	\$2,100	\$2,190	\$2,270	\$2,360	\$2,450	\$2,540
7' 0"	8' 0"	\$2,150	\$2,240	\$2,330	\$2,410	\$2,500	\$2,590	\$2,680
8' 0"	7' 0"	\$2,100	\$2,190	\$2,280	\$2,360	\$2,450	\$2,540	\$2,630
8' 0"	8' 0"	\$2,240	\$2,330	\$2,420	\$2,500	\$2,590	\$2,680	\$2,770

ELEVATION OPTIONS:

- 4" head up to 4' \$75
- 4" head up to 8' \$100

ANCHOR OPTIONS (all stainless steel):

- Masonry T MT NC
- Wire Anchors MW NC
- Metal Stud MS NC
- Wood Stud WS NC
- Prep for Exp Bolts* XB \$250
- * (includes SS bolts)

PROFILE OPTIONS (backbends and cased open):

- double rabbet single return (DRSR) NC
- double rabbet double return (DRDR) \$150
- single rabbet single return (SRSR) NC
- single rabbet double return (SRDR) \$150
- cased opening single return (COSR) NC
- cased opening double return (CODR) \$150

LABEL (Intertek WH):

- up to 3 hours \$75

WELDED FRAME CORNERS:

- #4 satin frame face corners are ground smooth to match jambs

DOOR POSITION SWITCH:

- Door position switch (1/2" to 1" dia.) NC

Prices subject to change without notice.

HARDWARE PREP OPTIONS

- HINGES:**
- 4 1/2" Reg Weight (45X) NC
 - 4 1/2" Extra Heavy (H45X) NC
 - 5" Extra Heavy (H50X) NC
 - Continuous Hinge Reinforcement (CH) NC (drilling and tapping not included)
 - Electric Hinge (EH) \$50

- LATCHING:**
- 4 7/8" ASA Strike (ASA) NC
 - 2 3/4" T Strike (T) NC
 - 2 3/4" Deadlock Strike (DL) NC
 - 3 1/2" Deadlock Strike (DLS312) NC
 - 4 7/8" Deadlock Strike (DLS478) NC
 - Electric Strike (ES) \$150
 - Rim Exit Device Reinforcement (RE) NC
 - Surface Vertical Rod Exit Device (SVRE) NC
 - ASA Flush Bolts (FB) NC
 - Surface Bolts (SB) NC
 - Surface Closer (CL) NC
 - Surface Overhead Holder/Stop (OS) NC
 - Concealed Closer (CC) \$130
 - Concealed Overhead Stop/Holder (COS) \$130
 - Concealed Vertical Rod Exit Device (CVRE) NC
 - Electric Power Transfer (EPT) \$150

NOTE: Stainless products are produced off-site and ship separately. Please call to verify and understand freight costs.

For Custom Options:

Call or email requests for quote prior to order submission with Job Name.

Customer Care: 1-877-671-7011 (ask for estimating)

e-mail: Steelcraftestimating@allegion.com

COMPLETE 16 GAUGE FRAME PRICING

Single Frame		JAMB DEPTH				
Width	Height	5 ³ / ₄ "-5 ⁷ / ₈ "	6"-7 ⁷ / ₈ "	8"-9 ⁷ / ₈ "	10"-11 ⁷ / ₈ "	12"-12 ³ / ₄ "
1'6" thru 3'0"	6'8"	\$1,353	\$1,373	\$1,457	\$1,546	\$1,690
	7'0"	\$1,365	\$1,388	\$1,472	\$1,567	\$1,715
	7'2"	\$1,370	\$1,393	\$1,482	\$1,578	\$1,727
	8'0"	\$1,421	\$1,446	\$1,542	\$1,649	\$1,809
	9'0"	\$1,481	\$1,511	\$1,618	\$1,739	\$1,919
Over 3'0" thru 4'0"	10'0"	\$1,519	\$1,552	\$1,668	\$1,802	\$1,994
	6'8"	\$1,372	\$1,390	\$1,482	\$1,575	\$1,728
	7'0"	\$1,384	\$1,405	\$1,497	\$1,596	\$1,753
	7'2"	\$1,389	\$1,410	\$1,507	\$1,607	\$1,765
	8'0"	\$1,440	\$1,463	\$1,567	\$1,678	\$1,847
9'0"	\$1,500	\$1,528	\$1,643	\$1,768	\$1,957	
10'0"	\$1,538	\$1,569	\$1,693	\$1,831	\$2,032	

Double Frame		JAMB DEPTH				
Width	Height	5 ³ / ₄ "-5 ⁷ / ₈ "	6"-7 ⁷ / ₈ "	8"-9 ⁷ / ₈ "	10"-11 ⁷ / ₈ "	12"-12 ³ / ₄ "
4'0" thru 6'0"	6'8"	\$1,462	\$1,488	\$1,593	\$1,713	\$1,893
	7'0"	\$1,476	\$1,502	\$1,609	\$1,731	\$1,915
	7'2"	\$1,480	\$1,508	\$1,619	\$1,745	\$1,929
	8'0"	\$1,532	\$1,560	\$1,679	\$1,815	\$2,011
	9'0"	\$1,590	\$1,626	\$1,757	\$1,905	\$2,121
Over 6'0" thru 8'0"	10'0"	\$1,632	\$1,666	\$1,805	\$1,971	\$2,195
	6'8"	\$1,497	\$1,526	\$1,636	\$1,764	\$1,951
	7'0"	\$1,511	\$1,540	\$1,652	\$1,782	\$1,973
	7'2"	\$1,515	\$1,546	\$1,662	\$1,796	\$1,987
	8'0"	\$1,567	\$1,598	\$1,722	\$1,866	\$2,069
Over 8'0" thru 9'11"	9'0"	\$1,625	\$1,664	\$1,800	\$1,956	\$2,179
	10'0"	\$1,667	\$1,704	\$1,848	\$2,022	\$2,253
	6'8"	\$1,519	\$1,547	\$1,663	\$1,797	\$1,990
	7'0"	\$1,533	\$1,561	\$1,679	\$1,815	\$2,012
	7'2"	\$1,537	\$1,567	\$1,689	\$1,829	\$2,026
8'0"	\$1,589	\$1,619	\$1,749	\$1,899	\$2,108	
9'0"	\$1,647	\$1,685	\$1,827	\$1,989	\$2,218	
10'0"	\$1,689	\$1,725	\$1,875	\$2,055	\$2,292	

COMPONENT PART PRICING

		JAMB DEPTH				
Part	Height	5 ³ / ₄ "-5 ⁷ / ₈ "	6"-7 ⁷ / ₈ "	8"-9 ⁷ / ₈ "	10"-11 ⁷ / ₈ "	12"-12 ³ / ₄ "
Strike Jamb	6'8"	\$462	\$468	\$504	\$539	\$594
	7'0"	\$467	\$476	\$511	\$551	\$608
	7'2"	\$470	\$478	\$516	\$555	\$613
	8'0"	\$495	\$505	\$546	\$591	\$654
	9'0"	\$526	\$537	\$583	\$636	\$709
	10'0"	\$543	\$558	\$609	\$666	\$747
Hinge Jamb	6'8"	\$478	\$486	\$519	\$556	\$613
	7'0"	\$485	\$493	\$527	\$565	\$624
	7'2"	\$487	\$496	\$532	\$572	\$631
	8'0"	\$513	\$522	\$562	\$607	\$672
	9'0"	\$542	\$555	\$601	\$652	\$727
	10'0"	\$563	\$575	\$625	\$685	\$764

		JAMB DEPTH				
Part	Width	5 ³ / ₄ "-5 ⁷ / ₈ "	6"-7 ⁷ / ₈ "	8"-9 ⁷ / ₈ "	10"-11 ⁷ / ₈ "	12"-12 ³ / ₄ "
Head	Thru 3'0"	\$413	\$419	\$434	\$451	\$483
	Thru 4'0"	\$432	\$436	\$459	\$480	\$521
	Thru 5'0"	\$468	\$476	\$507	\$541	\$593
	Thru 6'0"	\$506	\$516	\$555	\$601	\$667
	Thru 8'0"	\$541	\$554	\$598	\$652	\$725
	Thru 9'11"	\$563	\$575	\$625	\$685	\$764

NOTES:

General FT (Frame Thermal) information:

- Each component is assembled at the factory (see tech data)
- 3-Sided frames are die-mitered with corner tabs for knocked down (KD) assembly
- Factory welded option is face weld only
- Available in Galvannealed A-60 steel only
- Weld-in anchors welded from factory only

1. Jamb Depths:

- Double Rabbet Profile only
- Unequal (Std) or Equal Rabbet
- Single rabbet not available
- All frames listed are available in jamb depth increments of 1/8"

2. Door Opening Sizes:

- Standard frame sizes are listed
- Any non-standard frame width and/or height is priced as the next larger size frame category
- All components listed are available in length increments of 1/8"
- Available sizes:
 - Single: 1'6" x 6'8" thru 4'0" x 10'0"
 - Double: 4'0" x 6'8" thru 9'11" x 10'0"

3. Labeled Frames not available

NOTE:

1. *1/2" backbends on all JD including 5-3/4"
2. See Lineal Inch Stick Pricing section for FT lights/elevations
3. Nominal 3070 assembly tested per ASTM C1363 test standard. Reference FT tech data and SDI 113. All FT products use thermal break construction.

Prices subject to change without notice.

16 GAUGE THERMAL BREAK FRAMES FOR 1³/₄" DOORS

FT16 SERIES

FRAMES

Standard Construction Options: Per frame

4" FACE HEAD:	Thru 4'0"	Over 4'0"
	\$57	\$81

MARK NUMBERS (required):	N/C
EQUAL RABBET:	N/C
DUTCH FRAME:	N/A
COMMUNICATING FRAME:	N/A
SPECIAL PROFILE FRAME:	N/A
HOSPITAL SANITARY STOPS:	N/A
SILENCER PREPS:	N/A

ANCHORS (Factory welded only): Per frame/All JD

- Weld-in nailing strap anchors only (indicate single or double layer drywall)
- Weld-in base (uses FT Anchor as base) N/C
- Jambs thru 7'6" \$60
- Jambs over 7'6" thru 8'0" \$80
- Each additional \$10
- EMA (pierce, dimple, weld-in FT anchors with bolts only)
- Jambs thru 7'1" \$440
- Jambs over 7'1" thru 8'0" \$550
- Each additional location \$55

ANCHORS (Wire masonry loose, base weld-in): Per frame/All JD

- Weld-in base (uses FT Anchor as base) N/C
- Jambs thru 7'6" \$42
- Jambs over 7'6" thru 8'0" \$56

12 GAUGE HEAD REINFORCING CHANNEL:

- (2" face only, full jamb depth) N/A

Standard Hardware Options: Per prep

SPECIAL VERTICAL HARDWARE LOCATIONS:	
• Hinge and strike	N/C

CLOSERS/HOLDERS:

- Surface mounted:
- 14" (14 gauge) strap installed \$28 (specify regular, parallel arm or top jamb)
- Closer sleeve installed N/A
- Concealed in head (per template) N/A
- ALLE Concealed in head (per template) N/A

HINGES:

- 5" Universal in lieu of 4 1/2" N/C
- Additional hinge prep (4 1/2" or 5") \$21
- High frequency prep N/A
- Continuous hinge:
- No reinf. (blank jamb) N/C
- Full length reinf. \$81

STRIKES:

- Additional ASA (4 7/8" ANSI A115.1-2) \$21
- Additional Cylindrical (2 3/4" ANSI A115.3) \$21 (minimum 7" above or below standard strike)
- Double cylindrical (2 3/4") on 4" centers \$42
- Deadlock (non-lip) \$21
- Flushbolts:
- Steelcraft reversible \$57
- Standard (ANSI 115.4) \$57
- Surface Bolt reinf. \$29
- Exit Devices:
- Rim reinf. only \$29
- Vertical Rod reinf. only \$29
- Vertical Rod Mortise strike (each) N/A (see tech data for soffit mounted hardware restrictions)

ELECTRICAL PREPS:

- Power transfer units (i.e. EPT2, EPT10, etc.) \$133
- Electric hinge prep \$53
- Electric strike prep \$98
- Door position switch (1/2" or 1" dia.) \$53
- Magnetic switch (rectangular and mortised) N/A

NOTES:

1. Electric preps come standard with mortar guards
2. Avoid or take special care where hardware might interfere with the soffit, stop, and weather stripping; installation may be limited. On this page, certain options are omitted or listed as N/A where most hardware choices will cause problems. See technical data sheets for additional information.
3. Anchors
 - No default; anchors must be specified when ordered
 - EMA is not offered as punch and dimple only
 - To maintain thermal break and strength, all FT frames with welded anchors have 2 anchors at each vertical location (1 in each rabbet)

Prices subject to change without notice.

COMPLETE 14 GAUGE FRAME PRICING

Single Frame		JAMB DEPTH				
Width	Height	5 ³ / ₄ "-5 ⁷ / ₈ "	6"-7 ⁷ / ₈ "	8"-9 ⁷ / ₈ "	10"-11 ⁷ / ₈ "	12"-12 ³ / ₄ "
1'6" thru 3'0"	6'8"	\$1,413	\$1,460	\$1,562	\$1,617	\$1,804
	7'0"	\$1,427	\$1,475	\$1,582	\$1,642	\$1,834
	7'2"	\$1,434	\$1,485	\$1,593	\$1,650	\$1,846
	8'0"	\$1,494	\$1,550	\$1,668	\$1,738	\$1,949
	9'0"	\$1,556	\$1,620	\$1,756	\$1,830	\$2,064
Over 3'0" thru 4'0"	10'0"	\$1,603	\$1,669	\$1,816	\$1,898	\$2,152
	6'8"	\$1,433	\$1,485	\$1,593	\$1,650	\$1,847
	7'0"	\$1,447	\$1,500	\$1,613	\$1,675	\$1,877
	7'2"	\$1,454	\$1,510	\$1,624	\$1,683	\$1,889
	8'0"	\$1,514	\$1,575	\$1,699	\$1,771	\$1,992
9'0"	\$1,576	\$1,645	\$1,787	\$1,863	\$2,107	
10'0"	\$1,623	\$1,694	\$1,847	\$1,931	\$2,195	

Double Frame		JAMB DEPTH				
Width	Height	5 ³ / ₄ "-5 ⁷ / ₈ "	6"-7 ⁷ / ₈ "	8"-9 ⁷ / ₈ "	10"-11 ⁷ / ₈ "	12"-12 ³ / ₄ "
4'0" thru 6'0"	6'8"	\$1,532	\$1,593	\$1,727	\$1,801	\$2,032
	7'0"	\$1,546	\$1,609	\$1,747	\$1,825	\$2,062
	7'2"	\$1,554	\$1,619	\$1,757	\$1,833	\$2,076
	8'0"	\$1,614	\$1,685	\$1,833	\$1,921	\$2,178
	9'0"	\$1,674	\$1,757	\$1,921	\$2,013	\$2,294
Over 6'0" thru 8'0"	10'0"	\$1,724	\$1,803	\$1,983	\$2,083	\$2,380
	6'8"	\$1,571	\$1,636	\$1,778	\$1,854	\$2,101
	7'0"	\$1,585	\$1,652	\$1,798	\$1,878	\$2,131
	7'2"	\$1,593	\$1,662	\$1,808	\$1,886	\$2,145
	8'0"	\$1,653	\$1,728	\$1,884	\$1,974	\$2,247
Over 8'0" thru 9'11"	9'0"	\$1,713	\$1,800	\$1,972	\$2,066	\$2,363
	10'0"	\$1,763	\$1,846	\$2,034	\$2,136	\$2,449
	6'8"	\$1,596	\$1,662	\$1,811	\$1,890	\$2,142
	7'0"	\$1,610	\$1,678	\$1,831	\$1,914	\$2,172
	7'2"	\$1,618	\$1,688	\$1,841	\$1,922	\$2,186
8'0"	\$1,678	\$1,754	\$1,917	\$2,010	\$2,288	
9'0"	\$1,738	\$1,826	\$2,005	\$2,102	\$2,404	
10'0"	\$1,788	\$1,872	\$2,067	\$2,172	\$2,490	

COMPONENT PART PRICING

		JAMB DEPTH				
Width	Height	5 ³ / ₄ "-5 ⁷ / ₈ "	6"-7 ⁷ / ₈ "	8"-9 ⁷ / ₈ "	10"-11 ⁷ / ₈ "	12"-12 ³ / ₄ "
Strike Jamb	6'8"	\$486	\$505	\$545	\$567	\$640
	7'0"	\$493	\$512	\$555	\$580	\$655
	7'2"	\$496	\$517	\$561	\$584	\$660
	8'0"	\$526	\$549	\$598	\$628	\$712
	9'0"	\$558	\$583	\$642	\$674	\$769
	10'0"	\$580	\$609	\$671	\$707	\$814
Hinge Jamb	6'8"	\$500	\$519	\$561	\$583	\$656
	7'0"	\$507	\$527	\$571	\$595	\$671
	7'2"	\$511	\$532	\$576	\$599	\$678
	8'0"	\$541	\$565	\$614	\$643	\$729
	9'0"	\$571	\$601	\$658	\$689	\$787
	10'0"	\$596	\$624	\$689	\$724	\$830

		JAMB DEPTH				
Part	Width	5 ³ / ₄ "-5 ⁷ / ₈ "	6"-7 ⁷ / ₈ "	8"-9 ⁷ / ₈ "	10"-11 ⁷ / ₈ "	12"-12 ³ / ₄ "
Head	Thru 3'0"	\$427	\$436	\$456	\$467	\$508
	Thru 4'0"	\$447	\$461	\$487	\$500	\$551
	Thru 5'0"	\$489	\$508	\$545	\$565	\$635
	Thru 6'0"	\$532	\$555	\$605	\$635	\$720
	Thru 8'0"	\$571	\$598	\$656	\$688	\$789
	Thru 9'11"	\$596	\$624	\$689	\$724	\$830

NOTES:

General FT (Frame Thermal) information:

- Each component is assembled at the factory (see tech data)
- 3-Sided frames are die-mitered with corner tabs for knocked down (KD) assembly
- Factory welded option is face weld only
- Available in Galvannealed A-60 steel only
- Weld-in anchors welded from factory only

1. Jamb Depths:

- Double Rabbet Profile only
 - Unequal (Std) or Equal Rabbet
 - Single rabbet not available
- All frames listed are available in jamb depth increments of 1/8"

2. Door Opening Sizes:

- Standard frame sizes are listed
- Any non-standard frame width and/or height is priced as the next larger size frame category
- All components listed are available in length increments of 1/8"
- Available sizes:
 - Single: 1'6" x 6'8" thru 4'0" x 10'0"
 - Double: 4'0" x 6'8" thru 9'11" x 10'0"

3. Labeled Frames not available

NOTE:

- *1/2" backbends on all JD including 5-3/4"
- See Lineal Inch Stick Pricing section for FT lights/elevations
- Nominal 3070 assembly tested per ASTM C1363 test standard. Reference FT tech data and SDI 113. All FT products use thermal break construction.

Prices subject to change without notice.

14 GAUGE THERMAL BREAK FRAMES FOR 1³/₄" DOORS

FT14 SERIES

FRAMES

Standard Construction Options: Per frame

4" FACE HEAD:	Thru 4'0"	Over 4'0"
	\$57	\$81

MARK NUMBERS (required):	N/C
EQUAL RABBET:	N/C
DUTCH FRAME:	N/A
COMMUNICATING FRAME:	N/A
SPECIAL PROFILE FRAME:	N/A
HOSPITAL SANITARY STOPS:	N/A
SILENCER PREPS:	N/A

ANCHORS (Factory welded only): Per frame/All JD

- Weld-in nailing strap anchors only
(indicate single or double layer drywall)
 - Weld-in base (uses FT Anchor as base)
 - Jambs thru 7'6"
 - Jambs over 7'6" thru 8'0"
 - Each additional
- EMA (pierce, dimple, weld-in FT anchors with bolts only)
 - Jambs thru 7'1"
 - Jambs over 7'1" thru 8'0"
 - Each additional location

ANCHORS (Wire masonry loose, base weld-in): Per frame/All JD

- Weld-in base (uses FT Anchor as base)
- Jambs thru 7'6"
- Jambs over 7'6" thru 8'0"

12 GAUGE HEAD REINFORCING CHANNEL: (2" face only, full jamb depth)

Standard Hardware Options: Per prep

SPECIAL VERTICAL HARDWARE LOCATIONS:	
• Hinge and strike	N/C

CLOSERS/HOLDERS:

- Surface mounted:
 - 14" (14 gauge) strap installed
 - (specify regular, parallel arm or top jamb)
 - Closer sleeve installed
- Concealed in head (per template)
- ALLE Concealed in head (per template)

HINGES:

- 5" Universal in lieu of 4 1/2"
- Additional hinge prep (4 1/2" or 5")
- High frequency prep
- Continuous hinge:
 - No reinf. (blank jamb)
 - Full length reinf.

STRIKES:

- Additional ASA (4 7/8" ANSI A115.1-2)
 - Additional Cylindrical (2 3/4" ANSI A115.3)
 - (minimum 7" above or below standard strike)
 - Double cylindrical (2 3/4") on 4" centers
 - Deadlock (non-lip)
 - Flushbolts:
 - Steelcraft reversible
 - Standard (ANSI 115.4)
 - Surface Bolt reinf.
 - Exit Devices:
 - Rim reinf. only
 - Vertical Rod reinf. only
 - Vertical Rod Mortise strike (each)
- (see tech data for soffit mounted hardware restrictions)*

ELECTRICAL PREPS:

- Power transfer units (i.e. EPT2, EPT10, etc.)
- Electric hinge prep
- Electric strike prep
- Door position switch (1/2" or 1" dia.)
- Magnetic switch (rectangular and mortised)

NOTES:

1. Electric preps come standard with mortar guards
2. Avoid or take special care where hardware might interfere with the soffit, stop, and weather stripping; installation may be limited. On this page, certain options are omitted or listed as N/A where most hardware choices will cause problems. See technical data sheets for additional information.
3. Anchors
 - No default; anchors must be specified when ordered
 - EMA is not offered as punch and dimple only
 - To maintain thermal break and strength, all FT frames with welded anchors have 2 anchors at each vertical location (1 in each rabbet)

Prices subject to change without notice.

16 GAUGE CASING-READY FRAME (NO BACKBEND) FOR 1³/₄" DOORS

COMPLETE 16 GAUGE FRAME PRICING*

Single Frame		JAMB DEPTH (wall size + 1/8")				
Width	Height	4 5/8"-57/8"	6"-77/8"	8"-97/8"	10"-117/8"	12"-143/4"
1'6" thru 3'0"	6'8"	\$358	\$387	\$425	\$472	\$557
	7'0"	\$375	\$403	\$437	\$488	\$576
	7'2"	\$387	\$421	\$456	\$513	\$607
	8'0"	\$446	\$467	\$509	\$563	\$658
Over 3'0" thru 4'0"	9'0"	\$491	\$532	\$561	\$623	\$729
	6'8"	\$377	\$408	\$443	\$492	\$575
	7'0"	\$394	\$424	\$455	\$508	\$594
	7'2"	\$406	\$442	\$474	\$533	\$625
8'0"	\$465	\$488	\$527	\$583	\$676	
	9'0"	\$510	\$553	\$579	\$643	\$747

Double Frame		JAMB DEPTH (wall size + 1/8")				
Width	Height	4 5/8"-57/8"	6"-77/8"	8"-97/8"	10"-117/8"	12"-143/4"
4'0" thru 6'0"	6'8"	\$439	\$470	\$509	\$564	\$653
	7'0"	\$459	\$486	\$521	\$576	\$673
	7'2"	\$469	\$508	\$541	\$604	\$711
	8'0"	\$543	\$564	\$601	\$668	\$765
Over 6'0" thru 8'0"	9'0"	\$595	\$630	\$655	\$728	\$837
	350	\$466	\$499	\$546	\$597	\$687
	356	\$486	\$515	\$558	\$609	\$707
	368	\$496	\$537	\$578	\$637	\$745
408	\$570	\$593	\$638	\$701	\$799	
	428	\$622	\$659	\$692	\$761	\$871

COMPONENT PART PRICING*

JAMB DEPTH (wall size + 1/8")						
Width	Height	4 5/8"-57/8"	6"-77/8"	8"-97/8"	10"-117/8"	12"-143/4"
Strike Jamb	6'8"	\$138	\$147	\$159	\$175	\$204
	7'0"	\$145	\$155	\$165	\$185	\$213
	7'2"	\$152	\$162	\$174	\$196	\$225
	8'0"	\$174	\$180	\$197	\$214	\$249
	9'0"	\$193	\$212	\$222	\$244	\$284
Hinge Jamb	6'8"	\$155	\$166	\$179	\$197	\$227
	7'0"	\$165	\$174	\$185	\$203	\$237
	7'2"	\$170	\$185	\$195	\$217	\$256
	8'0"	\$207	\$213	\$225	\$249	\$283
	9'0"	\$233	\$246	\$252	\$279	\$319
JAMB DEPTH (wall size + 1/8")						
Heads	Thru 3'0"	\$65	\$74	\$87	\$100	\$126
	Thru 4'0"	\$84	\$95	\$105	\$120	\$144
	Thru 6'0"	\$129	\$138	\$151	\$170	\$199
	Thru 8'0"	\$156	\$167	\$188	\$203	\$233

*Pricing shown does not include standard options on next page

LABELED FRAMES : (NO CLOSER REINF)	Single	Pair
UL	N/A	N/A
ITS/WHI (no closer reinf, up to 90 min)		
· Metal label	\$28	\$56
· Mylar label	\$21	\$42
FM	N/A	N/A

Refer to the Steelcraft Tech Data Manual for all labeled approvals.

NOTES:

All frames have no backbends and have nail/screw attachment holes in all frame faces.

- **C series:** installed before wall with weld-in wood/ steel stud anchors and adjustable base standard, no compression anchors. Available KD or Welded.
- **CK series:** installed after drywall with compression anchors. KD only.

1. Jamb Depths:

- 4 5/8" min thru 14 3/4". Double, unequal rabbet
- All frames listed are available in jamb depth increments of 1/8"
- Jamb depth estimate calculation:
JD – Wall size (stud size + total drywall thickness) + 1/8"
- Consider variables that may increase the required JD to fit your wall as these frames can be less forgiving than frames with backbends to slide over wall. See tech data.

2. Door Opening Sizes:

- Standard frame sizes are listed
- Any non-standard frame width and/or height is priced as the next larger size frame category
- All components listed are available in size increments of 1/8"
- Available sizes
 - Single: 1'6" w x 2'0" h thru 4'0" w x 9'0" h
 - Double: 2'0" w x 2'0" h thru 8'0" w x 9'0" h
 - 2" Face only. Cased open not available.
 - Rough opening size is Nominal opening width plus 2" and Nominal opening height plus 1"

3. Anchors:

- Jamb depths over 9 1/8" include two (2) compression anchors per jamb (CK series only)
- All frames include attachment holes in face
 - Faces pre-punched 5/32" dia. at 16" max spacing for anchoring into wood or metal studs with #8 SS Tek screws or 10D-12D Nails max (wood stud). Fasteners not included.

4. Fire rated offering specifications

- 2" Face; JD 4 5/8" min thru 13 1/8" max
- Max single opening size 4080
- Max double opening size 8080
- C series shall be factory or field welded with proper wood/steel stud anchoring
- CK series shall use compression anchors and attachment nail/screw holes in all faces
- Double stud framed openings (back to back studs)
- Use only approved tapes/adhesives to attach casing

Prices subject to change without notice.

16 GAUGE CASING-READY FRAME (NO BACKBEND) FOR 1³/₄" DOORS

C AND CK SERIES

FRAMES

Standard Construction Options: Per frame

GALVANNEALED A-60 STEEL:		
• Complete frame		\$53
• Per jamb		\$20
• Per head		\$13

	Thru 4'0"	Over 4'0"
4" FACE HEAD:	N/A	N/A

MARK NUMBERS:	N/C
EQUAL RABBET:	N/A
SINGLE RABBET:	N/A
DUTCH FRAME:	N/A

COMMUNICATING FRAME: N/A

SPECIAL PROFILE FRAME: N/A

HOSPITAL SANITARY STOPS N/A

C SERIES ANCHORS: (Factory welded or prepped)

Per frame/All JD

• Weld-in wood (in lieu of loose)	Thru 9'¹/₈"	Over 9'¹/₈"
• Base (adjustable base std)	N/C	N/C
• Jambs thru 7'6"	\$42	\$60
• Jambs over 7'6" thru 9'0"	\$56	\$80
• Each additional	\$7	\$10

• Anchors may be omitted

• Anchor holes in face cannot be omitted

CK SERIES ANCHORS: (Factory welded or prepped)

• Compression anchor (typ \$13/jamb) \$29	\$58
• Compression anchor and attachment holes cannot be omitted	

12 GAUGE HEAD REINFORCING CHANNEL:

(2" face only, full jamb depth) N/A

Standard Hardware Options: Per prep

SPECIAL VERTICAL HARDWARE LOCATIONS:

• Hinge and strike N/C

CLOSERS/HOLDERS:

- Surface mounted:
 - 14" (14 gauge) strap installed \$28
(specify regular, parallel arm or top jamb)
 - Closer sleeve installed \$58
- Concealed in head (per template) N/A
- ALLE Concealed in head (per template...) N/A

HINGES:

- 5" Universal in lieu of 4 1/2" N/C
- Additional hinge prep (4 1/2" or 5") \$21
- High frequency prep N/A
- Continuous hinge:
 - No reinf. (blank jamb) N/C
 - Full length reinf. \$81

STRIKES:

- Additional ASA (4 7/8" ANSI A115.1-2) \$21
- Additional Cylindrical (2 3/4" ANSI A.11.5.3) \$21
(minimum 7" above or below standard strike)
- Double cylindrical (2 3/4") on 4" centers \$42
- Deadlock (non-lip) \$21
- Flushbolts:
 - Steelcraft reversible \$57
 - Standard (ANSI 115.4) \$57
 - Non-ANSI Prep N/A
- Surface Bolt reinf. \$29
- Exit Devices:
 - Rim reinf. only \$29
 - Vertical Rod reinf. only \$29
 - Vertical Rod Mortise strike (each) \$67
- Roller latch (each) \$43

ELECTRICAL PREPS:

- Power transfer units (i.e. EPT2, EPT.10, etc.) \$133
- Electric hinge prep \$53
- Electric strike prep N/A
- Door position switch (1/2" to 1" dia.) \$53
- Magnetic switch (rectangular and mortised) \$119

NOTES:

1. Hinge reinforcements do not include plaster guards (not necessary) to allow more options (e.g. when shifting the frame slightly to hinge side)
2. Over 7'2" required to use high frequency hinge reinforcement
3. Over 3070 should consider using heavier than 20ga studding (consult your engineer or architect)

Prices subject to change without notice.

14 GAUGE CASING-READY FRAME (NO BACKBEND) FOR 1³/₄" DOORS

COMPLETE 14 GAUGE FRAME PRICING*

Single Frame		JAMB DEPTH (wall size + 1/8")				
Width	Height	4 5/8"-5 7/8"	6"-7 7/8"	8"-9 7/8"	10"-11 7/8"	12"-14 3/4"
1'6" thru 3'0"	6'8"	\$431	\$453	\$489	\$547	\$647
	7'0"	\$446	\$468	\$505	\$566	\$669
	7'2"	\$462	\$488	\$528	\$592	\$699
	8'0"	\$525	\$547	\$585	\$649	\$755
Over 3'0" thru 4'0"	9'0"	\$582	\$618	\$655	\$727	\$849
	6'8"	\$442	\$466	\$502	\$564	\$656
	7'0"	\$457	\$481	\$518	\$583	\$678
	7'2"	\$473	\$501	\$541	\$609	\$708
	8'0"	\$536	\$560	\$598	\$666	\$764
	9'0"	\$593	\$631	\$668	\$744	\$858

Double Frame		JAMB DEPTH (wall size + 1/8")				
Width	Height	4 5/8"-5 7/8"	6"-7 7/8"	8"-9 7/8"	10"-11 7/8"	12"-14 3/4"
4'0" thru 6'0"	6'8"	\$511	\$541	\$574	\$640	\$736
	7'0"	\$523	\$553	\$594	\$650	\$750
	7'2"	\$543	\$581	\$620	\$680	\$796
	8'0"	\$623	\$649	\$686	\$750	\$854
Over 6'0" thru 8'0"	9'0"	\$687	\$719	\$758	\$828	\$952
	350	\$537	\$568	\$604	\$676	\$774
	356	\$549	\$580	\$624	\$686	\$788
	368	\$569	\$608	\$650	\$716	\$834
	408	\$649	\$676	\$716	\$786	\$892
	428	\$713	\$746	\$788	\$864	\$990

COMPONENT PART PRICING*

		JAMB DEPTH (wall size + 1/8")				
Width	Height	4 5/8"-5 7/8"	6"-7 7/8"	8"-9 7/8"	10"-11 7/8"	12"-14 3/4"
Strike Jamb	6'8"	\$164	\$172	\$182	\$198	\$230
	7'0"	\$173	\$181	\$188	\$212	\$245
	7'2"	\$179	\$187	\$198	\$223	\$252
	8'0"	\$202	\$212	\$222	\$245	\$279
	9'0"	\$227	\$248	\$256	\$284	\$324
Hinge Jamb	6'8"	\$179	\$188	\$197	\$221	\$255
	7'0"	\$185	\$194	\$207	\$226	\$262
	7'2"	\$195	\$208	\$220	\$241	\$285
	8'0"	\$235	\$242	\$253	\$276	\$314
	9'0"	\$267	\$277	\$289	\$315	\$363
		JAMB DEPTH (wall size + 1/8")				
Heads	Thru 3'0"	\$88	\$93	\$110	\$128	\$162
	Thru 4'0"	\$99	\$106	\$123	\$145	\$171
	Thru 6'0"	\$153	\$165	\$180	\$198	\$226
	Thru 8'0"	\$179	\$192	\$210	\$234	\$264

*Pricing shown does not include standard options on next page

LABELED FRAMES : (NO CLOSER REINF)	Single	Pair
UL	N/A	N/A
ITS/WHI (no closer reinf, up to 90 min)		
· Metal label	\$28	\$56
· Mylar label	\$21	\$42
FM	N/A	N/A

Refer to the Steelcraft Tech Data Manual for all labeled approvals.

NOTES:

All frames have no backbends and have nail/screw attachment holes in all frame faces.

- **C series:** installed before wall with weld-in wood/steel stud anchors and adjustable base standard, no compression anchors. Available KD or Welded.
- **CK series:** installed after drywall with compression anchors. KD only.

1. Jamb Depths:

- 4 5/8" min thru 14 3/4". Double, unequal rabbet only
- All frames listed are available in jamb depth increments of 1/8"
- Jamb depth estimate calculation:
JD = Wall size (stud size + total drywall thickness) + 1/8" to 1/4"
- Consider variables that may increase the required JD to fit your wall as these frames can be less forgiving than frames with backbends to slide over walls. See tech data.

2. Door Opening Sizes:

- Standard frame sizes are listed
- Any non-standard frame width and/or height is priced as the next larger size frame category
- All components listed are available in size increments of 1/8"
- Available sizes:
 - Single: 1'6"w x 2'0"h thru 4'0"w x 9'0"h
 - Double: 3'0"w x 2'0"h thru 8'0"w x 9'0"h
 - 2" Face only. Cased open not available.
- Rough opening size is Nominal opening width plus 2" and Nominal opening height plus

3. Anchors:

- Jamb depths over 9 1/8" include two (2) compression anchors per jamb (CK series only)
- All frames include attachment holes in face
 - Faces pre-punched 5/32" dia. at 16" max spacing for anchoring into wood or metal studs with #8 SS Tek screws or 10D-12D Nails max (wood stud). Fasteners not included.

4. Fire rated offering specifications

- 2" Face; JD 4 5/8" min thru 13 1/8" max
- Max single opening size 4080
- Max double opening size 8080
- C series shall be factory or field welded with proper wood/steel stud anchoring
- CK series shall use compression anchors and attachment nail/screw holes in all faces
- Double stud framed openings (back to back studs)
- Use only approved tapes/adhesives to attach casing

Prices subject to change without notice.

14 GAUGE CASING-READY FRAME (NO BACKBEND) FOR 1³/₄" DOORS

Standard Construction Options: Per frame

GALVANNEALED A-60 STEEL:

- Complete frame \$53
- Per jamb \$20
- Per head \$13

4" FACE HEAD:	Thru 4'0"	Over 4'0"
	N/A	N/A

MARK NUMBERS:	N/C
EQUAL RABBIT:	N/A
SINGLE RABBIT:	N/A
DUTCH FRAME:	N/A

COMMUNICATING FRAME: N/A

SPECIAL PROFILE FRAME: N/A

HOSPITAL SANITARY STOPS N/A

C SERIES ANCHORS: (Factory welded or prepped)

Per frame/All JD		
• Weld-in wood (in lieu of loose)	Thru 9¹/₈"	Over 9¹/₈"
• Base (adjustable base std) N/C	N/C	N/C
• Jamb thru 7'6" \$42	\$42	\$60
• Jamb over 7'6" thru 9'0" \$56	\$56	\$80
• Each additional \$7	\$7	\$10

• Anchors may be omitted
• Anchor holes in face cannot be omitted

CK SERIES ANCHORS: (Factory welded or prepped)

• Compression anchor (typ \$13/jamb) \$29	\$29
• Compression anchor and attachment holes cannot be omitted	

12 GAUGE HEAD REINFORCING CHANNEL:

(2" face only, full jamb depth)	N/A
---------------------------------------	-----

Standard Hardware Options: Per prep

SPECIAL VERTICAL HARDWARE LOCATIONS:

- Hinge and strike N/C

CLOSERS/HOLDERS:

- Surface mounted:
 - 14" (14 gauge) strap installed \$28
(specify regular, parallel arm or top jamb)
 - Closer sleeve installed \$58
- Concealed in head (per template) N/A
- ALLE Concealed in head (per template...) N/A

HINGES:

- 5" Universal in lieu of 4 1/2" N/C
- Additional hinge prep (4 1/2" or 5") \$21
- High frequency prep N/A
- Continuous hinge:
 - No reinf. (blank jamb) N/C
 - Full length reinf. \$81

STRIKES:

- Additional ASA (4 7/8" ANSI A115.1-2) \$21
- Additional Cylindrical (2 3/4" ANSI A.11.5.3) \$21
(minimum 7" above or below standard strike)
- Double cylindrical (2 3/4") on 4" centers \$42
- Deadlock (non-lip) \$21
- Flushbolts:
 - Steelcraft reversible \$57
 - Standard (ANSI 115.4) \$57
 - Non-ANSI Prep N/A
- Surface Bolt reinf. \$29
- Exit Devices:
 - Rim reinf. only \$29
 - Vertical Rod reinf. only \$29
 - Vertical Rod Mortise strike (each) \$67
- Roller latch (each) \$43

ELECTRICAL PREPS:

- Power transfer units (i.e. EPT2, EPT.10, etc.) \$133
- Electric hinge prep \$53
- Electric strike prep N/A
- Door position switch (1/2" to 1" dia.) \$53
- Magnetic switch (rectangular and mortised) \$119

NOTES:

1. Hinge reinforcements do not include plaster guards (not necessary) to allow more options (e.g. when shifting the frame slightly to hinge side)
2. Over 7'2" required to use high frequency hinge reinforcement
3. Over 3070 should consider using heavier than 20ga studding (consult your engineer or architect)

Prices subject to change without notice.

FRAME PROFILES

Standard Frame Parameters

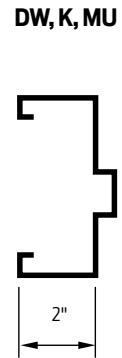
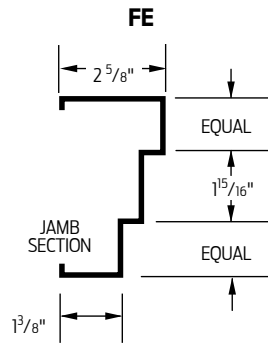
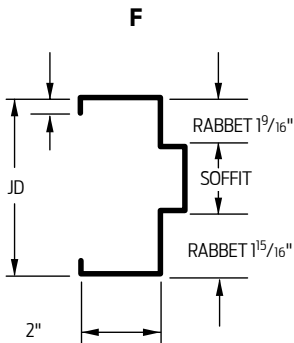

- F-Series frames are double rabbeted when soffit dimensions are:
 - 1 1/4" or more on label frames with masonry strap anchors
 - 1 1/4" or more on label frames with existing wall anchors
 - 1" or more on all other F-Series frames
(Frames will be single rabbet only when necessary, due to above minimum soffit dimensions)

- Available double rabbet only - see minimum soffit dimensions listed in F-Series frame column
- Maximum backbends 3/4"

- Minimum JD 4 3/4" non-label, 5 3/4" label
- Frames with faces as shown above are supplied with mitered corners and include corner tabs for KD assembly

- Minimum soffit dimension is 1"
- Single rabbet frames have one door rabbet and one 9/16" dummy rabbet

UNIT PRICE –

SPECIAL PROFILES: include any one or any combination (where applicable) of the following:

- Special face dimension 1 1/8" thru 2 1/2" max • F (2", 1 1/2" and 1" face standard)
- Special backbend dimension 3/8" thru 1" max • F, FN, DE, FE (1/2" and 7/16" on 5 3/4" frames only)
- Omit backends-SUA only (label and non-label), weld-in anchor (add)
- 3/4" thru 1 1/4" high stops in lieu of standard 5/8" stops
- Add to standard jamb depth frame.....\$59
- FE jambs with pocket pivots, special profile per jamb\$59

ADD PER FRAME

SPECIAL JAMB DEPTH OVER 14 3/4" F, MU, 14 or 16 gauge:

- Whole frame 14 3/4" jamb depth thru 20" jamb depth\$174
- Component part 14 3/4" jamb depth thru 20" jamb depth.....\$58

NOTES:

- Frames with face dimensions over 2 1/2" must be priced as lineal inch from the Sticks section.
- Consult factory for frames and profile options not shown above for pricing and availability.

Prices subject to change without notice.

CUSTOM FRAME OPTIONS

SPECIAL DOOR RABBET

	Single	Double
· Doors over 1 ³ / ₄ " thru 3" thick.....	\$239.....	\$335



NOTES:

1. Applicable frame series: labeled and non-labeled F, FN and MU (16 and 14 gauge only)
2. Includes special backset strike and regular or heavy weight hinge preps
3. Frame must be welded by factory or others
4. Price is for die mitered frame

Total Door frame prep (Model 100)

	Single	Double
· Prep for single and double frames	\$192.....	\$192

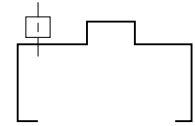

NOTES:

1. F-Series frame: labeled (UL only) and non-labeled
2. Prep includes blank hinge and strike jamb, 5/8" x 5/8" steel tube welded to strike jamb

WELDED FRAMES

	Face weld	Complete profile
· 2 Die mitered corners	\$113.....	\$202

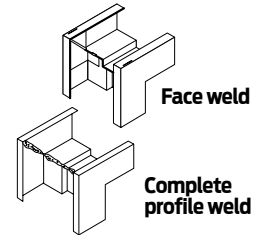

NOTES:

1. Three (3) sided frames, F, FN, FE, DE, MU, FT and FP-Series
2. FT Series welded is available as Face weld only

LEAD LINED FRAME PREP

Applicable frame series: F and MU-Series (labeled and non-labeled)	UNIT PRICE PER FRAME
· Lead clips only (installed in frame throat)	\$167

NOTES:

1. Lead furnished and installed by others
2. Wire masonry anchors only (labeled & non-labeled)
3. See Steelcraft Tech Data Manual for further details

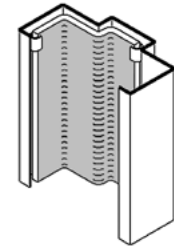

POCKET FRAME

Add to F-Series frame	UNIT PRICE PER FRAME
.....	\$216

NOTES:

1. Weld-in frame anchors are not included in the above price
2. Available KD only from the factory
3. 1/2" back bends only



ROUGH BUCK FRAME

Applicable frame series: F-Series non-labeled only	UNIT PRICE PER FRAME
· 14 gauge rough buck frame \$29 / lineal foot	
· 14 gauge rough buck end cap (each).....	\$126

NOTES:

1. Rough buck is 14 gauge only. Specify frame as 16 or 14 gauge
2. Add price to F-Series frame price. Refer to the Steelcraft Tech Data Manual for details

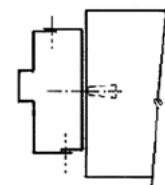

WELDED JAMB END-CAP FILLER

Applicable standard profile frame series: frame series: F and MU-Series, 16 and 14 gauge	UNIT PRICE PER END
------------------------------------------------------------------------------------------	---------------------------

· Saw mitered corner.....	\$135
· Square end	\$135

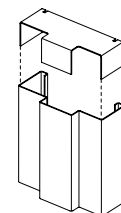

Prices subject to change without notice.

NAILING STRAP ANCHOR

Applicable frame series: F and MU-Series, welded-in

UNIT PRICE PER FRAME

- Jambs thru 7'6"\$42
- Jambs over 7'6"\$56

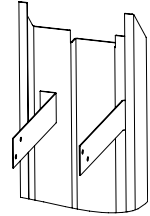

NAIL FLANGE RETURN

Applicable frame series: F-Series, 16 and 14 gauge

PRICE PER LINEAL INCH

Add for nailing flange on one or both returns\$0.64

NOTES:

1. Add total lineal inch charge to the applicable frame price
2. When ordering, specify the location of the nailing flange (door rabbet side, opposite, both)

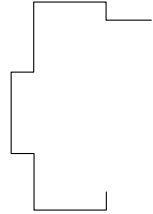

SPECIAL SIZE (height)

UNIT PRICE PER FRAME

- Frames over 10'0" thru 11'0"\$90

NOTE:

1. Add to 10'0" frame price, F-Series only

12 GAUGE REINF. OPTIONS

UNIT PRICE PER PREP

- Regular, parallel arm or top jamb\$39
- ASA strike (4 7/8" ANSI A115.1-2)\$65
- Continuous hinge reinf., full length\$104

KERFED FRAME OPTION

Integral Kerf Frame (Includes Seal) for Air Infiltration, Weather Seal and Smoke & Draft Control

Available on F, DW, K and MU-Series Frames

UNIT PRICE PER FRAME

- Preparation for Single and Double Frames\$178

NOTES:

1. 8'0" x 8'0" max opening size
2. Unequal, equal and single rabbet profiles
3. 16 gauge only

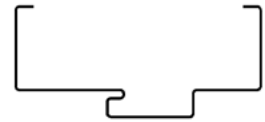

CONTINUOUS MORTAR GUARD

Factory installed, 18 gauge, full length mortar guard

Available on F & MU-Series frames\$215

EMA Additional Preparation Options

UNIT PRICE PER FRAME

Jambs Thru 7'1"	Jambs Over 7'1" thru 8'9"	Jambs Over 8'9" thru 10'0"
--------------------	------------------------------	-------------------------------

• **EMA (P&D with loose anchors)**

- Thru 9-1/8"\$92\$115\$138
- Over 9-1/8"\$184\$230\$276
- Each additional..... Thru 9-1/8" = \$11.50 and Over 9-1/8" = \$23

• **EMA (P&D with loose anchors/bolts)**

- Thru 9-1/8"\$156\$195\$234
- Over 9-1/8"\$312\$390\$468
- Each additional..... Thru 9-1/8" = \$19.50 and Over 9-1/8" = \$39

UNIT PRICE PER FRAME

Jambs Thru 7'1"	Jambs Over 7'1" thru 8'9"	Jambs Over 8'9" thru 10'0"
--------------------	------------------------------	-------------------------------

• **EMA (P&D with weld-in anchors (no bolts))**

- Thru 9-1/8"\$122\$152.50\$183
- Over 9-1/8"\$244\$305\$366
- Each additional..... Thru 9-1/8" = \$15.25 and Over 9-1/8" = \$30.50

• **EMA "TUBE and STRAP" (P&D, weld-in anchors, bolts)**

- Thru 9-1/8"\$258\$322.50\$387
- Over 9-1/8"\$516\$645\$774
- Each additional..... Thru 9-1/8" = \$32.25 and Over 9-1/8" = \$64.50

Prices subject to change without notice.

TABLE OF CONTENTS

DOOR PRODUCT INFORMATION 43

FULL FLUSH DOORS 44

 L-Series 44

 SL-Series 46

 B-Series 48

 T-Series 50

 LS-Series 69

 SZ-Series 70

EMBOSSED PANEL DOORS 52

 CE-Series 52

FULL GLASS ENTRANCE DOORS 54

 A14-Series 54

STORM RESISTANT DOORS 56

 H-Series Hurrican Resistant 56

 Paladin™-Series Tornado Resistant Doors and Frames 58

INTEGRATED DOOR SYSTEM 62

 INPACT™ Doors 62

GLASS LIGHTS 65

 Standard Light Sizes 65

 Factory Installed Kits 66

CUSTOM DOORS OPTIONS 67

 GRAINTECH™ 67

 Construction Options and Finish Paint 68

Prices subject to change without notice.

DOOR PRICING GUIDELINES AND POLICIES: The following guidelines and policies are followed when applying pricing to doors. Refer to the following price pages for the appropriate door series and options. Product specific price pages will override information printed on this page below and are subject to change without notice.

GENERAL:

Doors are supplied standard with factory applied primer, visible edge seams, beveled vertical edges and prepared for the noted hardware. Standard cores and options are as follows:

- L-Series: standard core is honeycomb
 - Option: polystyrene, polyurethane
- SL-Series: standard core is honeycomb, square vertical edges
 - Option: polystyrene
- B-Series: standard core is welded steel stiffeners with fiberglass batt insulation
 - Option: STC - Stiffened
- T-Series: standard core is mineral board
 - Option: none
- CE-Series: standard core is polystyrene
 - Option: none
- A14-Series: standard core is honeycomb
 - Option: none
- H-Series: standard core is honeycomb
 - Option: polystyrene, polyurethane welded steel stiffeners, mineral board
- Paladin™-Series: standard core is welded steel stiffeners
 - Option: none
- INPACT™ Integrated Door System: standard core is honeycomb
 - Option: polystyrene, polyurethane
- LS-Series: standard core is polystyrene
 - See LS section for any and all standards and options
- SZ-Series: Limited offering
 - See SZ section for any and all standards and options

SINGLE DOOR – HARDWARE PREPS:

The following hardware prep options are standard and included in single door pricing:

1. Hinge preps:

- Standard prep at no charge:
 - 4 1/2" Universal hinge preps
- Optional preps at no charge:
 - Blank hinge – no preps, no reinf.
 - 5" Universal hinge preps
 - Continuous hinge - no reinforcing standard
- Optional hinge preps with an up charge:
 - Refer to the individual price pages and the hardware preps section of this price book
- Number of hinges based on door height:
 - 2 hinges – up to 5'0" high
 - 3 hinges – up to and including 7'6" high
 - 4 hinges – over 7'6" high

2. Lock prep (one prep included):

- Standard prep at no charge:
 - Cylindrical / Bored lock - 161, 61L
 - Mortise lock - 86, 86ED
 - Blank lock – no prep, no reinf.
- Optional preps at no charge:
 - Cylindrical / Bored lock - 161ED
 - Mortise lock - sectional trim per template (ANSI A115.1)
 - Deadlock in lieu of standard lock
 - Cylindrical / Bored 161 or 160-4
 - Mortise 86

PAIRS OF DOOR – HARDWARE PREPS:

Price as two (2) single doors and add the appropriate pair charge which includes standard hardware locking preps and a standard astragal. The following options are standard and included in pricing for pairs of door:

1. Hinge preps – both leaves:

- Standard and optional preps same as single doors
- Number of hinges same as single doors

2. Active leaf lock prep:

- Standard and optional preps same as single doors

3. Inactive leaf prep:

NOTE: Due to hardware and astragal applications the inactive leaf options carry an up charge. Refer to the appropriate door series for further information.

- Standard preps with added pair charge
 - Locking / latching hardware with Z-Astragal included in pair of door charge:
 - Two (2) ANSI Flushbolt preps, one (1) 4 7/8" ANSI strike with Z-Astragal
 - Two (2) Surface Bolt reinf., one (1) 4 7/8" ANSI strike with Z-Astragal
 - Locking / latching hardware without an astragal included in pair of door charge:
 - Wide inactive leaf
 - Two (2) mortised ANSI Flushbolt preps, one (1) 4 7/8" ANSI strike
 - Two (2) Surface Bolt reinf., one (1) 4 7/8" ANSI strike

Prices subject to change without notice.

FLUSH DOOR PRICING

Door Width	20 GA.	18 GA.	16 GA.	14 GA.
UP TO 6'8" HIGH				
1'6" thru 2'8"	\$748	\$835	\$1,027	\$1,403
Over 2'8" thru 3'0"	\$781	\$843	\$1,044	\$1,415
Over 3'0" thru 3'6"	-	\$1,013	\$1,205	\$1,588
Over 3'6" thru 4'0"	-	\$1,116	\$1,305	\$1,675
UP TO 7'0" HIGH				
1'6" thru 2'8"	\$773	\$866	\$1,062	\$1,513
Over 2'8" thru 3'0"	\$796	\$872	\$1,045	\$1,461
Over 3'0" thru 3'6"	-	\$1,055	\$1,244	\$1,608
Over 3'6" thru 4'0"	-	\$1,164	\$1,341	\$1,735
UP TO 7'2" HIGH				
1'6" thru 2'8"	\$846	\$940	\$1,094	\$1,514
Over 2'8" thru 3'0"	\$895	\$965	\$1,131	\$1,535
Over 3'0" thru 3'6"	-	\$1,084	\$1,283	\$1,667
Over 3'6" thru 4'0"	-	\$1,227	\$1,442	\$1,796
UP TO 8'0" HIGH				
1'6" thru 2'8"	\$1,113	\$1,164	\$1,352	\$1,883
Over 2'8" thru 3'0"	\$1,143	\$1,195	\$1,394	\$1,901
Over 3'0" thru 3'6"	-	\$1,337	\$1,524	\$2,053
Over 3'6" thru 4'0"	-	\$1,442	\$1,608	\$2,141
UP TO 9'0" HIGH				
1'6" thru 3'0"	-	\$1,530	\$1,665	\$2,284
Over 3'0" thru 3'6"	-	\$1,701	\$1,920	\$2,298
Over 3'6" thru 4'0"	-	\$1,808	\$2,104	\$2,400
UP TO 10'0" HIGH				
1'6" thru 3'0"	-	\$1,711	\$1,930	\$2,335
Over 3'0" thru 4'0"	-	\$1,884	\$2,154	\$2,514

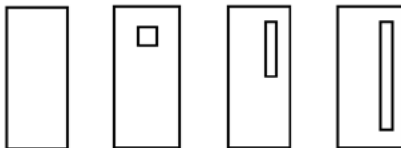

F V N, N3, N4, N5 LNL

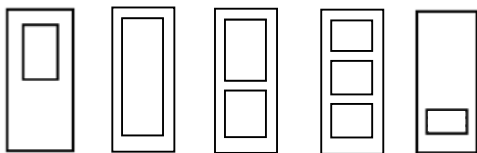

G FG FG2 FG3 LOUVER CUTOUT

Typical Elevations

NOTES:

1. Minimum size 1'6" x 2'0" / maximum size 4'0" x 10'0".
2. 20 gauge max size 3'0" x 8'0".
3. All FG door designs require full perimeter channels, max size 4'0" x 8'0". FG, FG2 and FG3 not available in 20 gauge.
4. Von Duprin 338 Filler Plate (Package Number 1205) may be required with use of existing frame in some applications. Refer to the Parts Section for package quantity and pricing.

Standard Construction Options:

Per leaf

PAIRS OF DOORS OR INACTIVE LEAVES (price pairs of doors as 2 single leaves):

- Conventional locking / latching hardware - add per pair \$95
 - **With Astragal** - Includes ANSI Flushbolt prep or Surface Bolt reinf. and 4 7/8" ANSI strike
 - **Without Astragal** - Includes wide inactive leaf, ANSI Flushbolt prep, or Surface Bolt reinf. and 4 7/8" ANSI strike
- Exit hardware and push pull without astragal - add per pair
 - Standard inactive leaf door width sizes N/C
 - Wide inactive leaf \$95
 - Add all appropriate hardware prep charges

GLASS LIGHTS: Designer Trim for 1/4" or 1/2" thick glass (1/4" standard):

- Standard size V, N3, N4 or N5 \$220
- Standard size G, N, LNL \$261
- Full Glass (FG) non-label only \$378
- Full Glass (FG2) label and non-label \$534
- Full Glass (FG3) label and non-label \$800
- Special size and glass thicknesses refer to Factory Installed Kits section

LIGHT / LOUVER CUTOUTS ONLY (per cutout):

- Non-labeled cutout only \$83
- Labeled and non-labeled cutout with channels \$162

NON-STANDARD SIZE WIDTHS and HEIGHTS price as next larger size door

CORE MATERIAL OPTIONS:

- Honeycomb standard
- Polystyrene \$38
- Polyurethane (non-labeled only) \$188

GALVANNEALED A-60 STEEL \$102

GALVANIZED G-90 STEEL \$407

- 18, 16 or 14 gauge only
- Maximum 3'8" x 10'0" door size

EDGE SEAM CONSTRUCTION OPTION:

- LF (Filled) \$112
- LW (Welded) 18, 16 and 14 gauge doors only \$164

UNDERCUT / FLOOR CLEARANCE (3/4" standard):

- Under 3/8" price as next larger size

TOP CAPS FACTORY INSTALLED:

- Screw-in (top or bottom) \$24

MARK NUMBERS N/C

DUTCH DOOR (shelf not included, shipped loose):

- Non-label \$323
- Label 16 or 18 gauge (add to a labeled door price) \$430
- Half shelf \$400
- Full shelf (non-labeled only) \$676
- Optional top latch into bottom \$293

LABELLED DOORS: (NO CLOSER REINF)	Single	Pair
UL: Metal label (no closer)		
• 3, 1 1/2, 1 or 3/4 hour	\$46	\$92
• 20 minute	\$19	\$38
ITS/WHI: Mylar label (no closer)		
• 3, 1 1/2, 1, 3/4 hour	\$46	\$92
• 20 minute or smoke & draft	\$19	\$38
• 1 1/2 hour (max. 4'0" x 7'2" single / 8'0 x 7'2" pair)	\$19	\$38
• Cross-corridor smoke barrier	\$46	\$92
FM: Mylar label (no closer)		
• 3, 1 1/2 or 3/4 hour	\$46	\$92
ASTM E-330: (Uniform Static Air Pressure)	\$19	\$38

Refer to the TD Manual for all labeled approvals

Standard Hardware Options: Per prep

SPECIAL VERTICAL HARDWARE LOCATIONS:

- Hinge and lock N/C

CLOSERS / HOLDERS / STOPS:

- Surface Mounted:
 - Closer – 20" reinf. only \$36
 - Holder / Stop – full door width reinf. \$72
- Concealed or semi-concealed (per template) \$360
- ALLE Concealed or semi-concealed (per template) \$314

PUSH / PULL REINF. \$39

HINGES:

- 5" Universal in lieu of 4 1/2" Universal N/C
- Additional hinge prep \$23
- High frequency prep \$56
- Continuous hinge (full/half mortise or surface)
 - No internal reinf. N/C
 - Internal edge or face reinf. \$85

LOCKS / LATCHES:

- Cylindrical Locks:
 - 3 3/4" or 5" backset \$48
- Mortise Locks:
 - Additional 86, 86ED at any one location \$51
(Minimum 12" from center to center)
- Hotel, Card Reader Locks:
 - (CISA™, Simplex, Tesa, VingCard) \$51

DOUBLE COMBO LOCKS:

- (2) 161 preps on 4" centers \$57
(160-4 or 160 centerlines may be 3 5/8" or 5 1/2")

DEADLOCKS:

- Deadlock prep at any one location \$59
(Minimum 7" above or below cylindrical lock)
Includes cylindrical, tubular or mortise type
- ALLE Deadlock prep per template \$51
- Additional 161 prep \$23
(Minimum 7" above or below standard lock)
- Standard 161, 160-4 or 86 in lieu of standard location N/C

STRIKES:

- Additional ASA (4 7/8" ANSI A115.1)
with or without astragal \$57
- Deadlock (non-lip) \$59
- Open Back Strike \$156

Standard Hardware Options: Per prep

ROLLER LATCH:

- Lock edge \$85
- Top edge \$85

EXIT DEVICES:

- Rim:
 - Reinf. only \$48
 - Prep per template \$54
- Mortise:
 - Prep per template \$86
 - ALLE prep per template \$69
- Surface Vertical Rod:
 - Reinf. only \$80
 - Prep per template \$96
 - ALLE prep per template \$84
- Concealed Vertical Rod:
 - Top and bottom rods (per template) \$593
 - Top rod only (per template) \$593
 - ALLE Concealed Vertical Rod \$462
- Von Duprin Concealed Vertical Cable:

HARDWARE PREP ONLY:

- Top and bottom latch (98/9949 or 33/3549A) \$462
- LBL (less bottom latch) (98/9949 or 33/3549A) \$462
(Refer to **Note 4** for Retrofit Application Requirements)

HARDWARE PREP AND FACTORY INSTALLED CABLES:

- Top and bottom latch (98/9949 or 33/3549A) \$1,854
- LBL (less bottom latch) (98/9949 or 33/3549A) \$1,854
(Refer to **Note 4** for Retrofit Application Requirements)
- Von Duprin INPACT™:

HARDWARE PREP 18 & 16GA ONLY:

- Mortise exit device \$462
- Vertical Rod (top rod only) \$462
- Vertical top and bottom rod \$462

HARDWARE PREP AND FACTORY INSTALLED DEVICE:
(See INPACT™ Integrated Door System section for factory installed device)

- Schlage Multipoint Lock: LM/LMV9300 \$2,998
(includes vertical rod installation)
- Schlage Two-point Lock: LM9200 \$462
(prep only, cables not included)

ELECTRICAL PREPS:

- Power transfer units (i.e. EPT2, EPT10, etc.) \$127
- Electric hinge prep \$24
- Electric strike prep \$131
- Door position switch (1/2" to 1" dia.) \$22
- Magnetic switch (rectangular and mortised) \$119
- Wiring race (with conduit) \$176

NOTE: Individual hardware preps do not include price or provisions for wiring raceways in the door. Raceways are an option to the hardware preps and must be ordered separately.

Prices subject to change without notice.

Indicates products that have EPD documentation available and meet LEED v4.

FLUSH DOOR PRICING

Door Width	20 GA.	18 GA.
UP TO 6'8" HIGH		
1'6" thru 2'8"	\$664	\$792
Over 2'8" thru 3'0"	\$689	\$805
Over 3'0" thru 3'6"	-	\$969
Over 3'6" thru 4'0"	-	\$1,065
UP TO 7'0" HIGH		
1'6" thru 2'8"	\$701	\$819
Over 2'8" thru 3'0"	\$700	\$818
Over 3'0" thru 3'6"	-	\$1,006
Over 3'6" thru 4'0"	-	\$1,111
UP TO 7'2" HIGH		
1'6" thru 2'8"	\$781	\$876
Over 2'8" thru 3'0"	\$802	\$884
Over 3'0" thru 3'6"	-	\$1,037
Over 3'6" thru 4'0"	-	\$1,142
UP TO 8'0" HIGH		
1'6" thru 2'8"	-	-
Over 2'8" thru 3'0"	\$1,009	\$1,141
Over 3'0" thru 3'6"	-	\$1,319
Over 3'6" thru 4'0"	-	\$1,433

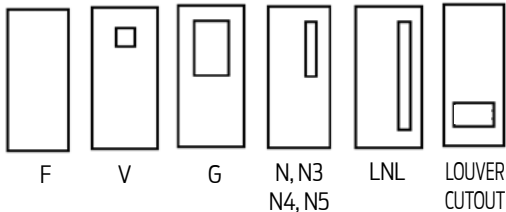

Typical Elevations

Standard Construction Options:

Per leaf

PAIRS OF DOORS OR INACTIVE LEAVES (price pairs of doors as 2 single leaves):

- Conventional locking / latching hardware - add per pair \$95
 - With Astragal – Includes ANSI Flushbolt prep or Surface Bolt reinf. and 4 7/8" ANSI strike
 - Without Astragal – Includes wide inactive leaf, ANSI Flushbolt prep, or Surface Bolt reinf. and 4 7/8" ANSI strike
- Non-latching hardware without astragal - add per pair..... N/C
 - For Rim, Vertical Rod and Push Pull applications
 - Blank lock edges, add all required hardware reinf.

GLASS LIGHTS Designer Trim for 1/4" or 1/2" thick glass (1/4" standard):

- Standard size V, N3, N4 or N5 \$220
- Standard size G, N \$261
- Standard size LNL non-label only \$261
- Full Glass (FG)..... not available
- Special size and glass thickness..... refer to Factory Installed Kits section

LOUVER CUTOUTS ONLY (per cutout):

- Non-labeled cutout only \$83
- Labeled and non-labeled cutout with channels \$162

NON-STANDARD SIZE WIDTHS and HEIGHTS price as next larger size door

CORE MATERIAL OPTIONS:

- Honeycomb standard
- Polystyrene \$38
- Polyurethane (non-labeled only)..... \$188

GALVANNEALED A-60 STEEL \$102

EDGE SEAM CONSTRUCTION OPTION not available

UNDERCUT / FLOOR CLEARANCE (3/4" standard):

- Under 3/8" price as next larger size

TOP CAPS FACTORY INSTALLED:

- Screw-in cap (top or bottom) \$24

MARK NUMBERS N/C

DUTCH DOOR not available

LABELED DOORS: (NO CLOSER REINF)	Single	Pair
UL: Metal label (no closer)		
• 3, 1 1/2, 1 or 3/4 hour	\$46	\$92
• 20 minute	\$19	\$38
ITS/WHI: Mylar label (no closer)		
• 3, 1 1/2, 1, 3/4 hour	\$46	\$92
• 20 minute or smoke & draft	\$19	\$38
• 1 1/2 hour (max. 4'0" x 7'2" single / 8'0 x 7'2" pair)	\$19	\$38
• Cross-corridor smoke barrier	\$46	\$92
FM: Mylar label (no closer)		
• 3, 1 1/2 or 3/4 hour	\$46	\$92
ASTM E-330: (Uniform Static Air Pressure)	N/A	N/A

Refer to the TD Manual for all labeled approvals

NOTE:

1. Minimum size 1'6" x 6'8" / maximum size 4'0" x 8'0"

Prices subject to change without notice.

Standard Hardware Options: Per prep

SPECIAL VERTICAL HARDWARE LOCATIONS:
 • Hinge and lock N/C

CLOSERS / HOLDERS / STOPS:
 • Surface Mounted:
 • Closer – 20" reinf. only \$36
 • Holder / Stop – full door width reinf. \$72
 • Concealed or semi-concealed N/A
 • ALLE Concealed or semi-concealed N/A

PUSH / PULL REINF.not available

HINGES:
 • 5"not available
 • Additional hinge prep\$23
 • High frequency prepnot available
 • Continuous hinge (full/half mortise or surface)
 • No internal reinf. N/C
 • Internal edge or face reinf. \$85

LOCKS / LATCHES:
 • Cylindrical Locks:
 • 3 3/4" or 5" backsetnot available
 • Mortise Locks:
 • Additional 86, 86ED at any one location. \$51
 (Minimum 12" from center to center)
 • Hotel, Card Reader Locks.not available

DOUBLE COMBO LOCKSnot available

DEADLOCKS:
 • Deadlock prep at any one location. \$59
 (Minimum 7" above or below cylindrical lock)
 Includes cylindrical, tubular or mortise type
 • ALLE Deadlock prep per template \$51
 • Additional 161 prep\$23
 (Minimum 7" above or below standard lock)
 • Standard 161, 160-4 or 86
 in lieu of standard location. N/C

STRIKES:
 • Additional ASA (4 7/8" ANSI A115.1)
 with or without astragalnot available
 • Deadlock (non-lip) \$59
 • Open Back Strikenot available

Standard Hardware Options: Per prep

ROLLER LATCHnot available

EXIT DEVICES:
 • Rim
 • Reinf. only \$48
 • Surface Vertical Rod
 • Reinf. only \$80

ELECTRICAL PREPSnot available

Prices subject to change without notice.

FLUSH DOOR PRICING

Door Width	18 GA.	16 GA.	14 GA.
UP TO 6'8" HIGH			
1'6" thru 2'8"	\$1,065	\$1,236	\$1,657
Over 2'8" thru 3'0"	\$1,078	\$1,299	\$1,664
Over 3'0" thru 3'6"	\$1,265	\$1,434	\$1,816
Over 3'6" thru 4'0"	\$1,379	\$1,512	\$1,923
UP TO 7'0" HIGH			
1'6" thru 2'8"	\$1,106	\$1,279	\$1,726
Over 2'8" thru 3'0"	\$1,116	\$1,311	\$1,733
Over 3'0" thru 3'6"	\$1,305	\$1,476	\$1,878
Over 3'6" thru 4'0"	\$1,397	\$1,544	\$1,978
UP TO 7'2" HIGH			
1'6" thru 2'8"	\$1,160	\$1,309	\$1,747
Over 2'8" thru 3'0"	\$1,191	\$1,358	\$1,758
Over 3'0" thru 3'6"	\$1,330	\$1,490	\$1,946
Over 3'6" thru 4'0"	\$1,401	\$1,600	\$2,055
UP TO 8'0" HIGH			
1'6" thru 3'0"	\$1,441	\$1,603	\$2,056
Over 3'0" thru 3'6"	\$1,584	\$1,769	\$2,183
Over 3'6" thru 4'0"	\$1,719	\$1,856	\$2,295
UP TO 9'0" HIGH			
1'6" thru 3'0"	\$1,791	\$2,015	\$2,495
Over 3'0" thru 3'6"	\$1,928	\$2,172	\$2,629
Over 3'6" thru 4'0"	\$1,961	\$2,255	\$2,748
UP TO 10'0" HIGH			
1'6" thru 3'0"	\$1,892	\$2,136	\$2,565
Over 3'0" thru 3'6"	\$2,076	\$2,179	\$2,800
Over 3'6" thru 4'0"	\$2,131	\$2,275	\$2,982

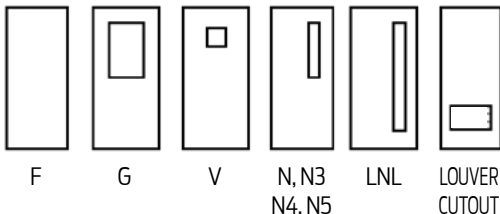

Typical Elevations

Standard Construction Options:

Per leaf

PAIRS OF DOORS OR INACTIVE LEAVES (price pairs of doors as 2 single leaves):

- Conventional locking / latching hardware - add per pair.....\$95
 - With Astragal - Includes ANSI Flushbolt prep or Surface Bolt reinf. and 4 7/8" ANSI Strike
 - Without Astragal - Includes wide inactive leaf, ANSI Flushbolt prep, or Surface Bolt reinf. and 4 7/8" ANSI strike
- Exit hardware and push pull without astragal - add per pair
 - Standard inactive leaf door width sizes.....N/C
 - Wide inactive leaf.....\$95
 - Add all appropriate hardware prep charges

GLASS LIGHTS Designer Trim for 1/4" or 1/2" thick glass (1/4" standard):

- Standard size V, N3, N4 or N5.....\$220
- Standard size G, N.....\$261
- Standard size LNL non-label only.....\$261
- Full Glass (FG).....not available
- Special size and glass thicknesses.....refer to Factory Installed Kits section

LIGHT / LOUVER CUTOUTS ONLY (per cutout):

- Non-Labeled cutout only.....not available
- Labeled and non-labeled cutout with channels.....\$162

NON-STANDARD SIZE WIDTHS and HEIGHTS price as next larger size door

CORE MATERIAL OPTIONS:

- Steel stiffened.....N/C
- STC-stiffened.....N/C

GALVANNEALED A-60 STEEL.....\$102

GALVANIZED G-90 STEEL.....not available

EDGE SEAM CONSTRUCTION OPTION:

- BF (Filled).....\$112
- BW (Welded).....\$164

UNDERCUT / FLOOR CLEARANCE (3/4" standard):

- Under 3/8".....price as next larger size door

TOP CAPS FACTORY INSTALLED:

- Screw-in cap (top or bottom).....\$24

MARK NUMBERS.....N/C

DUTCH DOOR (shelf not included, shipped loose):

- Non-label.....\$323
- Label 14, 16 or 18 gauge.....not available
- Half shelf.....\$400
- Full shelf (non-labeled only).....\$676
- Optional top latch into bottom.....\$293

LABELED DOORS: (NO CLOSER REINF)	Single	Pair
UL: Metal label (no closer)		
• 3, 1 1/2, 1 or 3/4 hour	\$46	\$92
• 20 minute	\$19	\$38
ITS/WHI:	N/A	N/A
FM:	N/A	N/A
ASTM E-330: (Uniform Static Air Pressure)	\$19	\$38

Refer to the Steelcraft Tech Data Manual for all labeled approvals.

NOTES:

- Minimum size 1'6" x 2'0" / maximum size 4'0" x 10'0"
- Von Duprin 338 Filler Plate (Package Number 1205) may be required with use of existing frame in some applications. Refer to the Parts Section for package quantity and pricing.

Prices subject to change without notice.

1 3/4" STEEL STIFFENED CORE

B-SERIES

DOORS

Standard Hardware Options: Per prep

SPECIAL VERTICAL HARDWARE LOCATIONS:

- Hinge and lock N/C

CLOSERS / HOLDERS / STOPS:

- Surface Mounted:
 - Closer – 20" reinf. only \$36
 - Holder / Stop – full door width reinf. \$72
- Concealed or semi-concealed (per template) \$360
- ALLE Concealed or semi-concealed (per template) \$314

PUSH / PULL REINF. \$39

HINGES:

- 5" Universal in lieu of 4 1/2" Universal N/C
- Additional hinge prep \$23
- High frequency prep \$56
- Continuous hinge (full / half mortise or surface)
 - No internal reinf. N/C
 - Internal edge or face reinf. \$85

LOCKS / LATCHES:

- Cylindrical Locks:
 - 3 3/4" or 5" backset \$48
- Mortise Locks:
 - Additional 86, 86ED at any one location \$51
(Minimum 12" from center to center)
- Hotel, Card Reader Locks:
 - (CISA™, Simplex, Tesa, VingCard) \$51

DOUBLE COMBO LOCKS:

- (2) 161 preps on 4" centers \$57
(160-4 or 160 centerlines may be 3 5/8" or 5 1/2")

DEADLOCKS:

- Deadlock prep at any one location \$59
(Minimum 7" above or below cylindrical lock)
Includes cylindrical, tubular or mortise type
- ALLE Deadlock prep per template \$51
- Additional 161 prep \$23
(Minimum 7" above or below standard lock)
- Standard 161, 160-4 or 86 in lieu of standard location N/C

STRIKES:

- Additional ASA (4 7/8" ANSI A115.1)
with or without astragal \$57
- Deadlock (non-lip) \$59
- Open Back Strike \$156

Standard Hardware Options: Per prep

ROLLER LATCH:

- Lock edge \$85
- Top edge \$85

EXIT DEVICES:

- Rim:
 - Reinf. only \$48
 - Prep per template \$54
- Mortise:
 - Prep per template \$86
 - ALLE prep per template \$69
- Surface Vertical Rod:
 - Reinf. only \$80
 - Prep per template \$96
 - ALLE prep per template \$84
- Concealed Vertical Rod:
 - Top and bottom rods (per template) \$593
 - Top rod only (per template) \$593
 - ALLE Concealed Vertical Rod \$462
- Von Duprin Concealed Vertical Cable:

HARDWARE PREP ONLY:

- Top and bottom latch (98/9949 or 33/3549A) \$462
- LBL (less bottom latch) (98/9949 or 33/3549A) \$462
(Refer to **Note 2** for Retrofit Application Requirements)

HARDWARE PREP AND FACTORY INSTALLED CABLES:

- Top and bottom latch (98/9949 or 33/3549A) \$1,854
- LBL (less bottom latch) (98/9949 or 33/3549A) \$1,854
(Refer to **Note 2** for Retrofit Application Requirements)
- Von Duprin INPACT™ not available
- Schlage MultiPoint Lock: LM/LMV9300 \$2,998
(includes vertical rod installation)
- Schlage Two-point Lock: LM9200 \$462
(prep only, cables not included)

ELECTRICAL PREPS:

- Power transfer units (i.e. EPT2, EPT10, etc.) \$127
- Electric hinge prep \$24
- Electric strike prep \$131
- Door position switch (1/2" to 1" dia.) \$22
- Magnetic switch (rectangular and mortised) \$119
- Wiring race (with conduit) \$176

NOTE: Individual hardware preps do not include price or provisions for wiring raceways in the door. Raceways are an option to the hardware preps and must be ordered separately.

Prices subject to change without notice.

FLUSH DOOR PRICING

Door Width	20 GA.	18 GA.	16 GA.	14 GA.
UP TO 6'8" HIGH				
1'6" thru 2'8"	\$1,743	\$1,830	\$2,022	\$2,398
Over 2'8" thru 3'0"	\$1,776	\$1,838	\$2,039	\$2,410
Over 3'0" thru 3'6"	-	\$2,008	\$2,200	\$2,583
Over 3'6" thru 4'0"	-	\$2,111	\$2,300	\$2,670
UP TO 7'0" HIGH				
1'6" thru 2'8"	\$1,768	\$1,861	\$2,057	\$2,508
Over 2'8" thru 3'0"	\$1,791	\$1,867	\$2,040	\$2,456
Over 3'0" thru 3'6"	-	\$2,050	\$2,239	\$2,603
Over 3'6" thru 4'0"	-	\$2,159	\$2,336	\$2,730
UP TO 7'2" HIGH				
1'6" thru 2'8"	\$1,877	\$1,935	\$2,089	\$2,509
Over 2'8" thru 3'0"	\$1,920	\$1,960	\$2,126	\$2,530
Over 3'0" thru 3'6"	-	\$2,079	\$2,278	\$2,662
Over 3'6" thru 4'0"	-	\$2,222	\$2,437	\$2,791
UP TO 8'0" HIGH				
1'6" thru 2'8"	\$2,135	\$2,159	\$2,347	\$2,878
Over 2'8" thru 3'0"	\$2,179	\$2,190	\$2,389	\$2,896
Over 3'0" thru 3'6"	-	\$2,332	\$2,519	\$3,048
Over 3'6" thru 4'0"	-	\$2,437	\$2,603	\$3,136
UP TO 9'0" HIGH				
1'6" thru 2'8"	-	\$2,525	\$2,660	\$3,279
Over 2'8" thru 3'0"	-	\$2,525	\$2,660	\$3,279
Over 3'0" thru 3'6"	-	\$2,696	\$2,915	\$3,293
Over 3'6" thru 4'0"	-	\$2,803	\$3,099	\$3,395

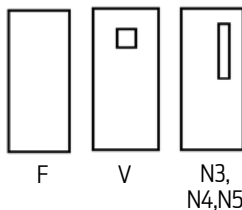

Typical Elevations

NOTES:

1. Maximum size 4'0" x 9'0" in 18, 16 and 14 gauge material
2. Maximum size 3'0" x 8'0" in 20 gauge material
3. Minimum size 1'6" x 2'0"
4. Von Duprin 338 Filler Plate (Package Number 1205) may be required with use of existing frame in some applications. Refer to the Parts Section for package quantity and pricing.

Standard Construction Options:

Per leaf

PAIRS OF DOORS OR INACTIVE LEAVES (price pairs of doors as 2 single leaves):

- Conventional locking / latching hardware - add per pair \$95
 - **With Astragal** – Includes ANSI Flushbolt prep or Surface Bolt reinf. and 4 7/8" ANSI strike
 - **Without Astragal** – Includes wide inactive leaf, ANSI Flushbolt prep, or Surface Bolt reinf. and 4 7/8" ANSI strike
- Exit hardware and push pull without astragal - add per pair
 - Standard inactive leaf door width sizes N/C
 - Wide inactive leaf \$95
 - Add all appropriate hardware prep charges

GLASS LIGHTS Designer Trim for 1/4" or 1/2" thick glass (1/4" standard):

- Standard size V, N3, N4 or N5 \$220
- Standard size G, N, LNL not available
- Full Glass (FG) non-label only not available

LIGHT CUTOUTS ONLY (per cutout):

- Cutout with channels \$162

NON-STANDARD SIZE WIDTHS and HEIGHTS price as next larger size door

CORE MATERIAL OPTIONS not available

GALVANNEALED A-60 STEEL \$102

GALVANIZED G-90 STEEL \$407

- 18, 16 or 14 gauge only
- Maximum 3'8" x 10'0" door size

EDGE SEAM CONSTRUCTION OPTION:

- TF (Filled) \$112
- TW (Welded) 18, 16 and 14 gauge doors only \$164

UNDERCUT / FLOOR CLEARANCE (3/4" standard):

- Under 3/8" price as next larger size door

TOP CAPS FACTORY INSTALLED:

- Screw-in cap (top or bottom) \$24

MARK NUMBERS N/C

DUTCH DOOR not available

LABELED DOORS: (NO CLOSER REINF)	Single	Pair
UL: Metal label (no closer) • 3 or 1 1/2,	\$46	\$92
ITS/WHI:	N/A	N/A
FM: Mylar label (no closer) • 3, 1 1/2	\$46	\$92
ASTM E-330: (Uniform Static Air Pressure)	\$19	\$38

Refer to the Steelcraft Tech Data Manual for all labeled approvals.

Prices subject to change without notice.

Standard Hardware Options: Per prep

SPECIAL VERTICAL HARDWARE LOCATIONS:
 • Hinge and lockN/C

CLOSERS / HOLDERS / STOPS:
 • Surface Mounted:
 • Closer – 20" reinf. only \$36
 • Holder / Stop – full door width reinf. \$72
 • Concealed or semi-concealed (per template)\$360
 • ALLE Concealed or semi-concealed (per template)\$314

PUSH / PULL REINF \$39

HINGES:
 • 5" Universal in lieu of 4 1/2" Universal N/C
 • Additional hinge prep\$23
 • High frequency prep \$56
 • Continuous hinge (full / half mortise or surface)
 • No internal reinf.N/C
 • Internal edge or face reinf.\$85

LOCKS / LATCHES:
 • Cylindrical Locks:
 • 3 3/4" or 5" backset \$48
 • Mortise Locks:
 • Additional 86, 86ED at any one location \$51
 (Minimum 12" from center to center)
 • Hotel, Card Reader Locks:
 (CISA™, Simplex, Tesa, VingCard) \$51

DOUBLE COMBO LOCKSnot available

DEADLOCKS:
 • Deadlock prep at any one location \$59
 (Minimum 7" above or below cylindrical lock)
 Includes cylindrical, tubular or mortise type
 • ALLE Deadlock prep per template \$51
 • Additional 161 prep\$23
 (Minimum 7" above or below standard lock)
 • Standard 161, 160-4 or 86 in lieu of standard location N/C

STRIKES:
 • Additional ASA (4 7/8" ANSI A115.1)
 with or without astragal\$57
 • Deadlock (non-lip)not available
 • Open Back Strikenot available

Standard Hardware Options: Per prep

ROLLER LATCHnot available

EXIT DEVICES:
 • Rim:
 • Reinf. only \$48
 • Prep per template \$54
 • Mortise:
 • Prep per template \$86
 • ALLE prep per template \$69
 • Surface Vertical Rod (450°):
 • Reinf. only \$80
 • Prep per template \$96
 • ALLE prep per template \$84
 • Concealed Vertical Rod (450°):
 • Top and bottom rods (per template) \$593
 • Top rod only (per template) \$593
 • ALLE Concealed Vertical Rod \$462
 • Von Duprin Concealed Vertical Cable (450°):

HARDWARE PREP ONLY:
 • Top and bottom latch (98/9949 or 33/3549A) \$462
 • LBL (less bottom latch) (98/9949 or 33/3549A) \$462
 (Refer to **Note 4** for Retrofit Application Requirements)





HARDWARE PREP AND FACTORY INSTALLED CABLES:
 • Top and bottom latch (98/9949 or 33/3549A) \$1,854
 • LBL (less bottom latch) (98/9949 or 33/3549A) \$1,854
 (Refer to **Note 4** for Retrofit Application Requirements)
 • Von Duprin INPACT™ (450°):

HARDWARE PREP 18 & 16GA ONLY:
 • Mortise exit device \$462
 • Vertical Rod (top rod only) \$462
 • Vertical top and bottom rod \$462

HARDWARE PREP AND FACTORY INSTALLED DEVICE:
 (See INPACT™ Integrated Door System section for factory installed device)
 • Schlage Two-point Lock: LM9200 \$462
 (prepare only, cables not included)

ELECTRICAL PREPS:
 • Power transfer units (i.e. EPT2, EPT10, etc.) \$127
 • Electric hinge prep \$24
 • Electric strike prep \$131
 • Door position switch (1/2" to 1" dia.) \$22
 • Magnetic switch (rectangular and mortised) \$119
 • Wiring race (with conduit) \$176
NOTE: Individual hardware preps do not include price or provisions for wiring raceways in the door. Raceways are an option to the hardware preps and must be ordered separately.

Prices subject to change without notice.

	E6 			E4TL 			HD2 		HD2A 	
Door Width	CE20	CE18	CE16	CE20	CE18	CE16	HD218	HD216	HD2A18	HD2A16
6'8" HIGH										
2'6"	\$963	\$1,192	\$1,423	-	-	-	-	-	-	-
2'8"	\$963	\$1,192	\$1,423	-	-	-	\$1,264	\$1,470	\$1,320	\$1,534
3'0"	\$1,005	\$1,192	\$1,423	\$1,395	\$1,518	\$1,783	\$1,298	\$1,507	\$1,353	\$1,561
3'4"	-	\$1,371	-	-	\$1,858	-	\$1,444	\$1,677	\$1,491	\$1,732
3'6"	-	\$1,371	-	-	\$1,858	-	\$1,444	\$1,677	-	-
3'8"	-	\$1,462	-	-	\$1,875	-	\$1,661	\$1,944	-	-
7'0" HIGH										
2'6"	\$1,005	\$1,263	\$1,388	\$1,394	\$1,496	\$1,769	-	-	-	-
2'8"	\$1,005	\$1,263	\$1,388	\$1,394	\$1,496	\$1,769	\$1,322	\$1,539	\$1,368	\$1,592
3'0"	\$1,045	\$1,263	\$1,443	\$1,435	\$1,530	\$1,823	\$1,359	\$1,577	\$1,395	\$1,644
3'4"	-	\$1,423	-	-	\$1,879	-	\$1,462	\$1,698	\$1,515	\$1,761
3'6"	-	\$1,423	-	-	\$1,879	-	\$1,462	\$1,698	-	-
3'8"	-	\$1,582	-	-	\$1,942	-	\$1,738	\$2,020	-	-
8'0" HIGH										
3'0"	\$1,308	\$1,535	\$1,807	\$1,813	\$2,110	-	-	-	-	-

NOTES:

1. Door heights between 7'0" and 8'0" are not available.
2. 8'0" door height is available in 3'0" width only.
3. CE-Series doors are A-40 galvalneal.
4. Min width 2'8" on HD embossment.
5. Max. width for HD2A design is 3'4"
6. Von Duprin 338 Filler Plate (Package Number 1205) may be required with use of existing frame in some applications. Refer to the Parts Section for package quantity and pricing.

LABELED DOORS: (NO CLOSER REINF)	Single	Pair
UL: Metal label (no closer) • 3, 1 1/2, 1 or 3/4 hour • 20 minute	\$46 \$19	\$92 \$38
ITS/WHI:	not available	not available
FM:	not available	not available
ASTM E-330: (Uniform Static Air Pressure)	\$19	\$38

Refer to the Steelcraft Tech Data Manual for all labeled approvals.

Standard Construction Options:

Per leaf

PAIRS OF DOORS OR INACTIVE LEAVES:

(price pairs of doors as 2 single leaves)

- Conventional locking / latching hardware - add per pair \$95
 - With Astragal – Includes ANSI Flushbolt prep or Surface Bolt reinf. and 4 7/8" ANSI strike
 - Without Astragal – Includes wide inactive leaf, ANSI Flushbolt prep, or Surface Bolt reinf. and 7/8" ANSI strike
- Exit hardware and push pull without astragal - add per pair
 - Standard inactive leaf door width sizes N/C
 - Wide inactive leaf \$95
 - Add all appropriate hardware prep charges

GLASS LIGHTS:

- Designer Trim for 1/4" or 1/2" thick glass (1/4" standard):
 - LNL, N, V, N3, N4 or N5 not available
 - Full Glass (FG) not available

LOUVER CUTOUTS ONLY not available

NON-STANDARD SIZE WIDTHS and HEIGHTS not available

CORE MATERIAL OPTIONS not available

GALVANNEALED A-60 STEEL not available

GALVANIZED G-90 STEEL not available

EDGE SEAM CONSTRUCTION OPTION:

- CEF (Filled) \$112
- CEW (Welded) not available

UNDERCUT / FLOOR CLEARANCE (3/4" standard):

- Under 3/8" price as next larger size

TOP CAPS FACTORY INSTALLED:

- Screw-in cap (top or bottom) \$24

MARK NUMBERS N/C

DUTCH DOOR not available

Prices subject to change without notice.

1 3/4" EMBOSSED PANEL

GALVANNEALED AND POLYSTYRENE CORE

CE-SERIES

DOORS

Standard Hardware Options: Per prep

SPECIAL VERTICAL HARDWARE LOCATIONS:

- Hinge and lock N/C

CLOSERS / HOLDERS / STOPS:

- Surface Mounted:
 - Closer – 20" reinf. only \$36
 - Holder / Stop – full door width reinf. \$72
- Concealed or semi-concealed (per template) \$360
- ALLE Concealed or semi-concealed (per template) \$314

PUSH / PULL REINF \$39

HINGES:

- 5" Universal in lieu of 4 1/2" Universal N/C
- Additional hinge prep \$23
- High frequency prep \$56
- Continuous hinge (full / half mortise or surface)
 - No internal reinf. N/C
 - Internal edge or face reinf. \$85

LOCKS / LATCHES:

- Cylindrical Locks:
 - 3 3/4" or 5" backset \$48
- Mortise Locks:
 - Additional 86, 86ED at any one location \$51
(Minimum 12" from center to center)
- Hotel, Card Reader Locks:
 - (CISA™, Simplex, Tesa, VingCard) \$51

DOUBLE COMBO LOCKS:

- (2) 161 preps on 4" centers \$57
(160-4 or 160 centerlines may be 3 5/8" or 5 1/2")

DEADLOCKS:

- Deadlock prep at any one location \$59
(Minimum 7" above or below cylindrical lock)
Includes cylindrical, tubular or mortise type
- ALLE Deadlock prep per template \$51
- Additional 161 prep \$23
(Minimum 7" above or below standard lock)
- Standard 161, 160-4 or 86 in lieu of standard location N/C

STRIKES:

- Additional ASA (4 7/8" ANSI A115.1)
with or without astragal \$57
- Deadlock (non-lip) \$59
- Open Back Strike \$156

Standard Hardware Options: Per prep

ROLLER LATCH:

- Lock edge \$85
- Top edge \$85

EXIT DEVICES:

- Rim:
 - Reinf. only \$48
 - Prep per template \$54
- Mortise:
 - Prep per template \$86
 - ALLE Prep per template \$69
- Surface Vertical Rod:
 - Reinf. only \$80
 - Prep per template \$96
 - ALLE prep per template \$84
- Concealed Vertical Rod:
 - Top and bottom rods (per template) \$593
 - Top rod only (per template) \$593
 - ALLE Concealed Vertical Rod \$462
- Von Duprin INPACT™ not available
- Von Duprin Concealed Vertical Cable:

HARDWARE PREP ONLY:

- Top and bottom latch (98/9949 or 33/3549A) \$462
- LBL (less bottom latch) (98/9949 or 33/3549A) \$462
(Refer to **Note 5** for Retrofit Application Requirements)

HARDWARE PREP AND FACTORY INSTALLED CABLES:

- Top and bottom latch (98/9949 or 33/3549A) \$1,854
- LBL (less bottom latch) (98/9949 or 33/3549A) \$1,854
(Refer to **Note 5** for Retrofit Application Requirements)
- Schlage Two-point Lock: LM9200 \$462
(prep only, cables not included)

ELECTRICAL PREPS:

- Power transfer units (i.e. EPT2, EPT10, etc.) \$129
- Electric hinge prep \$24
- Electric strike prep \$131
- Door position switch (1/2" to 1" dia.) \$22
- Magnetic switch (rectangular and mortised) \$119
- Wiring race (with conduit) \$176

NOTE: Individual hardware preps do not include price or provisions for wiring raceways in the door. Raceways are an option to the hardware preps and must be ordered separately.

Prices subject to change without notice.

ENTRANCE DOOR PRICING

Door Width	FG	FG2	FG3
UP TO 6'8" HIGH			
2'0" thru 2'8"	\$1,796	\$2,156	\$2,590
Over 2'8" thru 3'0"	\$1,839	\$2,184	\$2,635
Over 3'0" thru 3'6"	\$1,885	\$2,230	\$2,771
Over 3'6" thru 3'8"	\$1,943	\$2,257	\$2,789
Over 3'8" thru 4'0"	\$2,002	\$2,314	\$2,803
UP TO 7'0" HIGH			
2'0" thru 2'8"	\$1,853	\$2,184	\$2,635
Over 2'8" thru 3'0"	\$1,898	\$2,224	\$2,676
Over 3'0" thru 3'6"	\$1,943	\$2,274	\$2,721
Over 3'6" thru 3'8"	\$2,002	\$2,314	\$2,782
Over 3'8" thru 4'0"	\$2,055	\$2,385	\$2,836
UP TO 7'2" HIGH			
2'0" thru 2'8"	\$1,885	\$2,199	\$2,665
Over 2'8" thru 3'0"	\$1,926	\$2,241	\$2,708
Over 3'0" thru 3'6"	\$1,979	\$2,307	\$2,757
Over 3'6" thru 3'8"	\$2,036	\$2,350	\$2,816
Over 3'8" thru 4'0"	\$2,094	\$2,408	\$2,876
UP TO 8'0" HIGH			
2'0" thru 2'8"	\$2,003	\$2,466	\$2,843
Over 2'8" thru 3'0"	\$2,062	\$2,497	\$2,966
Over 3'0" thru 3'6"	\$2,105	\$2,541	\$3,008
Over 3'6" thru 3'8"	\$2,136	\$2,598	\$3,038
Over 3'8" thru 4'0"	\$2,193	\$2,615	\$3,052

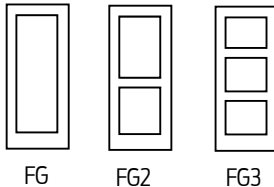

Typical Elevations

NOTES:

1. Minimum size 2'0" x 6'8" / maximum size 4'0" x 8'0"
2. Top rail 6 1/4" minimum thru 24" maximum to expose glass
3. Bottom rail 11 1/4" minimum thru 24" maximum to exposed glass
4. Bottom surface bolt must be thru bolted
5. Von Duprin 338 Filler Plate (Package Number 1205) may be required with use of existing frame in some applications. Refer to the Parts Section for package quantity and pricing.

Standard Construction Options:

Per leaf

PAIRS OF DOORS OR INACTIVE LEAVES (price pairs of doors as 2 single leaves):

- Conventional locking / latching hardware - add per pair \$95
 - **With Astragal** – Includes ANSI Flushbolt prep or Surface Bolt reinf. and 4 7/8" ANSI strike
 - **Without Astragal** – Includes wide inactive leaf, ANSI Flushbolt prep, or Surface Bolt reinf. and 4 7/8" ANSI strike
- Exit hardware and push pull without astragal - add per pair
 - Standard inactive leaf door width sizes N/C
 - Wide inactive leaf \$95
 - Add all appropriate hardware prep charges

GLASS LIGHTS refer to pricing table

- Special glass thicknesses refer to Factory Installed Kits section

LIGHT / LOUVER CUTOUTS ONLY N/C

NON-STANDARD SIZE WIDTHS and HEIGHTS price as next larger size door

CORE MATERIAL OPTIONS:

- Honeycomb standard

GALVANNEALED A-60 STEEL \$102

GALVANIZED G-90 STEEL \$407

- Maximum 3'8" x 8'0" door size

EDGE SEAM CONSTRUCTION OPTION:

- AF (Filled) standard
- AW (Welded) not available

UNDERCUT / FLOOR CLEARANCE (3/4" standard):

- Under 3/8" price as next larger size

TOP CAPS FACTORY INSTALLED:

- Screw-in cap (top or bottom) \$24

MARK NUMBERS N/C

DUTCH DOOR not available

LABELED DOORS: (NO CLOSER REINF)	Single	Pair
UL: Metal label (no closer)		
• 3, 1 1/2, 1 or 3/4 hour	\$46	\$92
• 20 minute	\$19	\$38
ITS/WHI:	N/A	N/A
FM:	N/A	N/A
ASTM E-330: (Uniform Static Air Pressure)	N/A	N/A

Refer to the Steelcraft Tech Data Manual for all labeled approvals.

Prices subject to change without notice.

Standard Hardware Options: Per prep

SPECIAL VERTICAL HARDWARE LOCATIONS:
 • Hinge and lock N/C

CLOSERS / HOLDERS / STOPS:
 • Surface Mounted:
 • Closer – 20" reinf. only \$36
 • Holder / Stop – full door width reinf. \$72
 • Concealed or semi-concealed (per template) \$360
 • ALLE Concealed or semi-concealed (per template) \$314

PUSH / PULL REINF \$39

HINGES:
 • 5" Universal in lieu of 4 1/2" Universal N/C
 • Additional hinge prep \$23
 • High frequency prep \$56
 • Continuous hinge (full / half mortise or surface)
 • No internal reinf. N/C
 • Internal edge or face reinf. \$85

LOCKS / LATCHES:
 • Cylindrical Locks:
 • 3 3/4" or 5" backset not available
 • Mortise Locks:
 • Additional 86, 86ED at any one location \$51
 (Minimum 12" from center to center)
 • Hotel, Card Reader Locks:
 (CISA™, Simplex, Tesa, VingCard) \$51

DOUBLE COMBO LOCKS:
 • (2) 161 preps on 4" centers \$57
 (160-4 or 160 centerlines may be 3 5/8" or 5 1/2")

DEADLOCKS:
 • Deadlock prep at any one location \$59
 (Minimum 7" above or below cylindrical lock)
 Includes cylindrical, tubular or mortise type
 • ALLE Deadlock prep per template \$51
 • Additional 161 prep \$23
 (Minimum 7" above or below standard lock)
 • Standard 161, 160-4 or 86 in lieu of standard location N/C

STRIKES:
 • Additional ASA (4 7/8" ANSI A115.1)
 with or without astragal \$57
 • Deadlock (non-lip) \$59
 • Open Back Strike \$156

Standard Hardware Options: Per prep

ROLLER LATCH:
 • Lock edge \$85
 • Top edge \$85

EXIT DEVICES:
 • Rim:
 • Reinf. only \$48
 • Prep per template \$54
 • Mortise:
 • Prep per template \$86
 • ALLE prep per template \$69
 • Surface Vertical Rod:
 • Reinf. only \$80
 • Prep per template \$96
 • ALLE prep per template \$84
 • Concealed Vertical Rod:
 • Top and bottom rods (per template) \$593
 • Top rod only (per template) \$593
 • ALLE Concealed Vertical Rod \$462
 • Von Duprin INPACT™ not available
 • Von Duprin Concealed Vertical Cable:

HARDWARE PREP ONLY:
 • Top and bottom latch (98/9949 or 33/3549A) \$462
 • LBL (less bottom latch) (98/9949 or 33/3549A) \$462
 (Refer to **Note 5** for Retrofit Application Requirements)

HARDWARE PREP AND FACTORY INSTALLED CABLES:
 • Top and bottom latch (98/9949 or 33/3549A) \$1,854
 • LBL (less bottom latch) (98/9949 or 33/3549A) \$1,854
 (Refer to **Note 5** for Retrofit Application Requirements)
 • Schlage Two-point Lock: LM9200 \$462
 (prep only, cables not included)

ELECTRICAL PREPS:
 • Power transfer units (i.e. EPT2, EPT10, etc.) \$127
 • Electric hinge prep \$24
 • Electric strike prep \$131
 • Door position switch (1/2" to 1" dia.) \$22
 • Magnetic switch (rectangular and mortised) \$119
 • Wiring race (with conduit) \$176

NOTE: Individual hardware preps do not include price or provisions for wiring raceways in the door. Raceways are an option to the hardware preps and must be ordered separately.

Prices subject to change without notice.

FLUSH DOOR PRICING

Door Width	H16	H14	H16-E6	HE16-E4TL	HE16-HD2	HE16-HD2A
UP TO 6'8" HIGH						
1'6" thru 2'8"	\$1,327	\$1,602	\$1,612	-	\$1,703	\$1,767
Over 2'8" thru 3'0"	\$1,398	\$1,703	\$1,697	\$2,016	\$1,740	\$1,794
Over 3'0" thru 3'6"	\$1,534	\$1,865	-	-	\$1,910	\$1,965
Over 3'6" thru 4'0"	\$1,631	\$1,932	-	-	\$2,177	-
UP TO 7'0" HIGH						
1'6" thru 2'8"	\$1,368	\$1,689	\$1,664	\$2,002	\$1,772	\$1,825
Over 2'8" thru 3'0"	\$1,423	\$1,776	\$1,730	\$2,056	\$1,810	\$1,877
Over 3'0" thru 3'6"	\$1,589	\$1,932	-	-	\$1,910	\$1,994
Over 3'6" thru 4'0"	\$1,672	\$2,007	-	-	\$2,253	-
UP TO 7'2" HIGH						
1'6" thru 2'8"	\$1,398	\$1,719	-	-	-	-
Over 2'8" thru 3'0"	\$1,452	\$1,806	-	-	-	-
Over 3'0" thru 3'6"	\$1,605	\$1,976	-	-	-	-
Over 3'6" thru 4'0"	\$1,687	\$2,063	-	-	-	-
UP TO 8'0" HIGH						
1'6" thru 3'0"	\$1,781	\$2,251	\$2,244	-	-	-
Over 3'0" thru 3'6"	\$1,918	\$2,353	-	-	-	-
Over 3'6" thru 4'0"	\$1,987	\$2,419	-	-	-	-
UP TO 9'0" HIGH						
1'6" thru 3'0"	\$2,227	\$2,789	-	-	-	-
Over 3'0" thru 3'6"	\$2,420	\$2,941	-	-	-	-
Over 3'6" thru 4'0"	\$2,483	\$2,996	-	-	-	-
UP TO 10'0" HIGH						
1'6" thru 3'0"	\$2,733	\$3,377	-	-	-	-
Over 3'0" thru 3'6"	\$2,930	\$3,529	-	-	-	-
Over 3'6" thru 4'0"	\$2,992	\$3,586	-	-	-	-

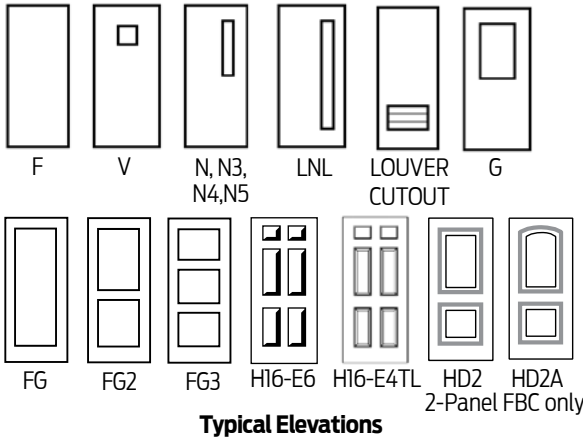

Typical Elevations

NOTES:

Standard items included with flush and glazed doors:

- A-60 galvaneal, honeycomb core, prime painted
- 3/8" undercut
- Florida Building Code label
- HE-Series, embossed:
 - A-40 galvaneal
 - Polystyrene core
 - E6 panel design as H16-E6
- Approved hardware required
- Reference CE-Series for available HE16 door widths
- HE16 8'0" High available in 3'0" width only
- Opening heights **over 8'0"** are not FBC or Miami-Dade approved
- Please confirm glass availability before placing door order.
- See **Paladin Series** for FBC EHPA Hurricane/Tornado Labeled assemblies per FL41734.1. Not available with shutters, glass lights, or Securitech hardware.

Standard Construction Options:

Per leaf

PAIRS OF DOORS OR INACTIVE LEAVES

(price pairs of doors as 2 single leaves):

- Conventional locking / latching hardware - add per pair. \$95
 - With Astragal – Includes 4 7/8" ANSI strike prep and Surface Bolt reinf. (flushbolts not available)
 - Without Astragal – Requires two (2) active leaves
- Push pull without astragalnot available

GLASS LIGHTS Designer Trim for 1/4" or 1/2" thick glass (1/2" standard):

- Standard size V, N3, N4 or N5 non-label only. \$299
- Standard size G, N, LNL non-label only \$395
- Full Glass (FG) non-label only \$457
- Full Glass (FG2) non-label only \$692
- Full Glass (FG3) non-label only \$1,037
- Special size and glass thicknesses refer to Factory Installed Kits section

LIGHT / LOUVER CUTOUTS ONLY (per cutout):

- Non-labeled cutout onlynot available
- Labeled and non-labeled cutout with channels. \$162

NON-STANDARD SIZE WIDTHS and HEIGHTS . price as next larger size door

CORE MATERIAL OPTIONS:

- Honeycomb standard
- Polystyrene \$38
- Vertical steel stiffened (20 gauge stiffeners only) \$291
- Polyurethane (non-labeled only) \$188
- Temperature Rise (TH-Series) \$957

GALVANNEALED A-60 STEEL N/C

GALVANIZED G-90 STEEL

(16&14 ga only, Max 3'8"x10'0" door size, No Stiffened Cores) \$407

EDGE SEAM CONSTRUCTION OPTION:

- HF (Filled) \$112
- HW (Welded) H-Series only \$164

UNDERCUT / FLOOR CLEARANCE (3/8" standard):

- Under 3/8" N/C

TOP CAPS FACTORY INSTALLED:

- Screw-in cap (top) N/C

MARK NUMBERS N/C

DUTCH DOOR not available

LABELED DOORS: (NO CLOSER REINF)	Single	Pair
UL only: (Metal label (no closer) • 3, 1 1/2, 1, or 3/4 hour • 20 minute	\$46 \$19	\$92 \$38
FBC Impact:	included	
FBC E330/Non-impact: For Standard Doors • L14/16/18, SL18, B14/16/18, T14/16/18, CE16/18	\$19	\$38
Dade County label	\$19	\$38
TDI: Use FBC labels per TDI Third-Party Eval. Reports	FBC label included	

LABELED 3-SIDED FRAMES : (NO CLOSER REINF)	Single	Pair
UL only: (no closer reinf) Metal label 3 hr in stud partition (includes stiffeners in head)	\$28 \$34	\$56 \$68
FBC Impact and E330/Non-impact: F12/14/16, MU14/16	\$21	\$42
Dade County label	\$34	\$45
TDI: Use FBC labels per TDI Third-Party Eval. Reports	FBC label included	

For Frames and E330 door pricing/construction, see standard series price pages. Refer to FBC/MD/TDI Third-Party (FBC) Listings to verify approved options and anchoring. E330 assemblies typically require door labels only.

Prices subject to change without notice.

1 3/4" HURRICANE DOORS

H-SERIES

DOORS

Standard Hardware Options: Per prep

SPECIAL VERTICAL HARDWARE LOCATIONS:

- Hinge and locknot available

CLOSERS / HOLDERS / STOPS:

- Surface Mounted:
 - Closer – 20" reinf. only \$36
 - Holder / Stop – full door width reinf..... \$72
- Concealed or semi-concealednot available
- ALLE Concealed or semi-concealednot available

PUSH / PULL REINFnot available

HINGES:

- 5" Universal in lieu of 4 1/2" Universal N/C
- Additional hinge prep\$23
- High frequency prep\$56
- Continuous hinge (full mortise)
 - No internal reinf..... N/C
 - Internal edge reinf..... \$85

LOCKS / LATCHES:

- Cylindrical Locks:
 - 161 or 61L
- 2 3/4" backset N/C
- Mortise Locks:
 - Additional 86, 86ED at any one location \$51
(Minimum 12" from center to center)
- Hotel, Card Reader Locks: (Locknetics)..... \$51

DOUBLE COMBO LOCKS:

- (2) 161 preps on 4" centers\$57
(160-4 or 160 centerlines may be 3 5/8" or 5 1/2")

DEADLOCKS:

- Deadlock prep at any one location \$59
(Minimum 7" above or below cylindrical lock)
Includes cylindrical, tubular or mortise type
- ALLE Deadlock prep per template \$51
- Additional 161 prep\$23
(Minimum 7" above or below standard lock)
- Standard 161, 160-4 or 86 in lieu of standard locationnot available

STRIKES:

- Additional ASA (4 7/8" ANSI A115.1) with astragal \$57
- Deadlock (non-lip) \$59
- Open Back Strikenot available

Standard Hardware Options: Per prep

ROLLER LATCHnot available

EXIT DEVICES:

- Rim:
 - Reinf. only \$48
 - Prep per template \$54
- Mortise:
 - Prep per template \$86
 - ALLE prep per template \$69
- Surface Vertical Rod:
 - Reinf. only \$80
 - Prep per template \$86
 - ALLE prep per template \$84
- Concealed Vertical Rod:
 - Top and bottom rods (per template) \$593
 - Top rod only (per template) \$593
 - ALLE Concealed Vertical Rod \$462
- Von Duprin INPACT™not available
- Von Duprin Concealed Vertical Cable:

HARDWARE PREP ONLY:

- Top and bottom latch (98/9949 or 33/3549A \$462
- LBL (less bottom latch) (98/9949 or 33/3549A \$462
(Refer to note 2 for Retrofit application requirements)

HARDWARE PREP AND FACTORY INSTALLED CABLES:

- Top and bottom latch (98/9949 or 33/3549A \$1,854
- LBL (less bottom latch) (98/9949 or 33/3549A \$1,854
(Refer to note 2 for Retrofit application requirements)
- Schlage Multipoint Lock: LM/LMV9300 \$2,998
(includes vertical rod installation)

ELECTRICAL PREPS:

- Power transfer units (i.e. EPT2, EPT10, etc.) \$127
- Electric hinge prep \$24
- Electric strike prep \$131
- Door position switch (1/2" to 1" dia.) \$22
- Magnetic switch (rectangular and mortised) \$119
- Wiring race (with conduit) \$176

NOTES:

1. Individual hardware preps do not include price or provisions for wiring raceways into the door. Raceways are an option to the hardware prep and must be ordered separately.
2. Von Duprin 338 Filler Plate (Package number 1205) may be required with use of existing frame in some application. Refer to Parts Section for package quantity and pricing.
3. FAS-SEAL™ door bottom sweeps are required For all Hurricane listing approvals. Order per door from the Parts Section for field prep and install.

Prices subject to change without notice.

FLUSH DOOR PRICING

Door Width	14 Gauge
UP TO 6'8" HIGH	
Single 3'0" thru 4'0"	\$6,492
Pairs 6'0" thru 8'0"	\$12,984
UP TO 7'0" HIGH	
Single 3'0" thru 4'0"	\$6,955
Pairs 6'0" thru 8'0"	\$13,910
UP TO 7'2" HIGH	
Single 3'0" thru 4'0"	\$7,575
Pairs 6'0" thru 8'0"	\$15,150
UP TO 8'0" HIGH	
Single 3'0" thru 4'0"	\$8,191
Pairs 6'0" thru 8'0"	\$16,382

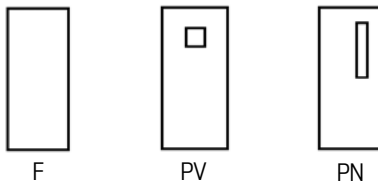

Available Elevations

***SHUTTER DOOR PRICING**

Door Width	14 Gauge
UP TO 6'8" HIGH	
Single 2'8" thru 4'0"	\$6,492
Pairs 5'4" thru 8'0"	\$12,984
UP TO 7'0" HIGH	
Single 2'8" thru 4'0"	\$6,955
Pairs 5'4" thru 8'0"	\$13,910
UP TO 7'2" HIGH	
Single 2'8" thru 4'0"	\$7,575
Pairs 5'4" thru 8'0"	\$15,150
UP TO 8'0" HIGH	
Single 2'8" thru 4'0"	\$8,191
Pairs 5'4" thru 8'0"	\$16,382

*Available as Flush doors only; no glass allowed.
 *Available only with Schlage LM9300 multipoint locks.

NOTES:

- 3-sided, Minimum size 3'0" x 6'8" / maximum size 8'0" x 8'0"
- 4-sided, Minimum size 2'8" x 4'3" / maximum size 8'0" x 8'0"
- Glass light assembly only available with standard factory installed glass
- All hardware functions must be specified. Refer to the Tornado Resistant Approvals in the Steelcraft Tech Data Manual
- Paired opening prices shown are for applications with or without astragals
- See above for undercuts (1/4" max between door and finished floor/threshold)
- FBC EHPA Hurricane/Tornado Label can be added to ICC500 label for flush door assemblies only per FL41734.1. Securitech hardware and shutters N/A.

Standard Construction Options:

Per leaf

- PAIRS OF DOORS OR INACTIVE LEAVES** (price pairs of doors as 2 single leaves):
- Conventional locking / latching hardware - add per pair \$95
 - With Astragal – Includes Surface Bolt reinf. and 4 7/8" ANSI strike (not recommended with panic exit hardware)
 - Without Astragal – Includes wide inactive leaf, SB360 Surface bolt reinf., and 4 7/8" ANSI strike \$95
 - Push pull without astragal not available
- GLASS LIGHT ASSY:** Factory installed and approved Glass and Trim, 3-Sided Only (no shutters)
- Paladin Vision (PV) non-label (9 1/2" x 9 1/2") \$5,205
 - Paladin Vision (PVF) label (9 1/2" x 9 1/2") \$10,263
 - Paladin Narrow (PN) non-label (4 1/8" x 26 11/16") \$5,639
 - Paladin Narrow (PNF) label (4 1/8" x 26 11/16") \$10,695
- NON-STANDARD SIZE WIDTHS and HEIGHTS** price as next larger size door
- LIGHT / LOUVER CUTOUTS ONLY** not available
- CORE MATERIAL OPTIONS** not available
- GALVANIZED A-60 STEEL** standard
- GALVANIZED G-90 STEEL** not available
- EDGE SEAM CONSTRUCTION OPTION:**
- PF (Filled) not available
 - PW (Welded and Seam filled) standard
- UNDERCUT / FLOOR CLEARANCE** (3/4" standard for 1/2" ADA saddle threshold): (See hardware installation instructions and Steelcraft tech data for undercut guidance. Typical undercut must provide 1/4" max between bottom of door and top of finished floor/threshold; critical distance - bottom of door to top of strike 1/8-1/4" for LM and 1/8" for WS devices).
- Under 3/8" price as next larger size
- 12 GA TOP CHANNEL SERVES AS TOP CAP** standard
- MARK NUMBERS** N/C
- DUTCH DOOR** not available

Available Sizes:

	Single		Pair	
	Min.	Max.	Min.	Max.
3-Sided & Glass	3'0" x 6'8"	4'0" x 8'0"	6'0" x 6'8"	8'0" x 8'0"
4-Sided & Shutters	2'8" x 4'3"	4'0" x 8'0"	5'4" x 4'3"	8'0" x 8'0"

LABELED DOORS: (NO CLOSER REINF)	Single	Pair
UL:	N/A	N/A
ITS/WHI: Metal label no closer) *3, 1 1/2, 1, 3/4 hour or 20 min	\$46	\$92
20 minute or smoke & draft	\$19	\$38
FM:	N/A	N/A
ICC500-2014 / FEMA 361/320 Label	N/C	N/C
FBC EHPA Hurricane/Tornado Label	\$19	\$38

*Glass lights rated up to 1-1/2 hours max
 Refer to the Steelcraft Tech Data Manual for all labeled approvals.

Prices subject to change without notice.

Standard Hardware Options:	Per prep	Standard Hardware Options:	Per prep
SPECIAL VERTICAL HARDWARE LOCATIONS:		DOUBLE COMBO LOCKS:	not available
• Hinge and lock	N/C	DEADLOCKS:	not available
SURFACE MOUNTED CLOSERS / HOLDERS / STOPS:		STRIKES:	not available
• Surface Mounted Closers:		ROLLER LATCH:	
• 20" reinf	standard	• Lock edge:	not available
• Holder / Stop – full door width reinf.	\$72	• Top edge:	not available
• Approved models - LCN 4000T, 4010, 4010T, 4020, 4020T, 4030, 4030T, 4040XP, 4040XPT, 4050, 4110, 4110T		Electrical Preps (Reviewed by engineering / not available in OEW):	
• Approved models - FALCON SC70 (heavy duty), SC80A, SC60A		• Power transfer units (i.e. EPT2, EPT10, etc)	\$127
• Concealed or semi-concealed (per template)	not available	• Approved models - Von Duprin EPT2, EPT1	
• ALLE Concealed or semi-concealed (per template)	not available	• Electric hinge prep	\$24
• Surface Overhead Holder/Stop	specify reinf in available closer preps	• Auto Operators	N/C (specify reinf in available closer preps)
• Approved models - GJ 79S (extra heavy duty), 70S, 90S, 81S (Confirm that your choice opens 180° if needed and as configured).		• Approved models - LCN 9953 for pairs, 9542 for singles (must be mounted to exterior/storm side of storm shelter or safe room). MUST order 5" heavy weight hinges and high frequency hinge reinforcements.	
• Surface Floor & Wall Stops / Holders	thru bolted (no prep)	• Electric door closer	N/C (specify reinf in available closer preps)
• Approved models - IVES (attached to exterior with steel screws per manufacturers instructions. Interior application must use IVES FS495 thru bolted to the door, at the bottom only) only, min 6" from lock or strike side of door.		• Approved models - LCN Sentronic 4040SE, 4310ME (may be mounted on interior or exterior side of storm shelter or safe room. 4040SE exterior side only.)	
PUSH / PULL REINF	not available	• Magnetic Hold open	specify reinf in available closer preps
HINGES:		• Approved models - LCN SEM 7800 (extenders not permitted on inswing applications. Locate away from hardware/rod locations to avoid interference).	
• 5" Universal in lieu of 4 1/2" Universal	N/C	• Door position switch (round 1/2" to 1" dia)	\$22
• Approved models: IVES 3CB1, 3CB1HW, 3CB1NRP, 3CB1HWNRP, 3CB1SH, 3CB1HWSH, 5BB1, 5BB1HW, 5BB1NRP, 5BB1HWNRP, 5BB1SH, 5BB1HWSH, 5BB1WT, 5BB1HW WT		• Approved models - Schlage 679-05, Sentrol 1078/1076 (mortised into the hinge edge of the door).	
• Additional hinge prep	\$23	• Wiring race (with conduit)	\$176
• High frequency prep	\$56	KICK PLATES:	no preps
Continuous hinge (Full mortise only)		• Approved models - IVES 8400 (metal or plastic), 8402 (metal) (must be secured with steel screws, 48" max height bottom of door only).	
• No internal reinf	N/C	THRESHOLDS & GASKETING:	no preps
• Internal edge reinf	\$85	• Approved models - ZERO (must not impede or affect the function of the opening or latching hardware)	
• Approved models - IVES Alum Geared: 112HD, 112XY, 224HD, 224XY			
• Approved models - IVES Steel Pin & Barrel: 600,700,700CS, 705			
• Approved models - IVES Electric: TW8, TWP			
LOCKS / LATCHES (LEVERS):	Prep only unless noted:		
• Schlage MultiPoint with installed concealed vertical rods (CVR)			
• 3-point: LM/LMV9300 (rose or escutcheon trim)	\$2,998		
• IVES SB360 Top and bottom surface bolts for inactive leaf	N/C		
• Securitech concealed rods (field drilled)			
• 2-point: 52xx-V (vert deadbolt top & bottom)	\$735		
• 3 point: 53xx (primary and vert deadbolts)	\$735		
• 3-point: 8L (primary and vert deadbolts)	\$735		
• Optional HVL HOVE bottom jamb (with 53xx)	\$110		
• 7L Series with IHD concealed rods and HOVE bottom jamb bolt	\$990		
• FEMA 320 only solution:			
• Securitech ATAR RB-100 Series with Schlage ND lockset.			
• Bottom bolt uses HVL jamb bolt	\$969		
• Medeco 3-deadbolts with Schlage ND lockset or Falcon T-Series	\$183		
EXIT DEVICES (PANIC BARS):	Prep only:		
• Von Duprin, panic bar exit with SVR (surface rods, reinf only)			
• Von Duprin exit with surface vertical rods (SVR)			
• 2-point: WS98/9927 Fire rated only with pair	N/C		
• 3-point: WS98/9957 Fire rated only with single	N/C		
• Securitech 3-point surface rods (field drilled)			
• Securitech 8T Series	\$851		
• Optional HVL HOVE bottom jamb bolt	\$110		
• Securitech 3-point IHD concealed rods (field drilled)			
• Securitech 7T Series with IHD concealed rods and HOVE bottom jamb bolt (HVL)	\$969		

- NOTES:**
1. Only approved models are allowed; for more information on approvals see Tech Data, tornado section.
 2. WS available as EO (exit only); NL (night latch) not available.
 3. Electronic options available with Allegion WS device and Securitech 7L, 7T, and 8T series.
 4. Securitech approved options include 4pt stationary bolt in hinge jamb and door edge n/c (field drilled, no additional door or frame preps). Typ 54xx, 7x04, or 84xx when ordering hardware from Securitech.

Prices subject to change without notice.

FP14 COMPLETE FRAME PRICING

Single Frame		JAMB DEPTH			
Width	Height	5 3/4"-57/8"	6"-77/8"	8"-97/8"	10"-103/4"
2'8" thru 4'0"	6'8"	\$747	\$808	\$876	\$939
	7'0"	\$802	\$857	\$928	\$986
	7'2"	\$889	\$942	\$1,014	\$1,072
	8'0"	\$1,003	\$1,058	\$1,130	\$1,191

Double Frame		JAMB DEPTH			
Width	Height	5 3/4"-57/8"	6"-77/8"	8"-97/8"	10"-103/4"
5'4" thru 8'0"	6'8"	\$1,024	\$1,101	\$1,172	\$1,236
	7'0"	\$1,070	\$1,139	\$1,212	\$1,276
	7'2"	\$1,156	\$1,219	\$1,300	\$1,362
	8'0"	\$1,284	\$1,355	\$1,434	\$1,496

Paladin frames cannot be ordered as separate components

Available Sizes:	Single		Pair	
	Min.	Max.	Min.	Max.
3-Sided & Glass	3'0" x 6'8"	4'0" x 8'0"	6'0" x 6'8"	8'0" x 8'0"
4-Sided & Shutters	2'8" x 4'3"	4'0" x 8'0"	5'4" x 4'3"	8'0" x 8'0"

NOTES:

- Jamb Depths
 - All FP frames are double rabbet only
 - Max JD 10 3/4". All frames listed are available in jamb depth increments of 1/8".
- Door Opening Sizes
 - Standard frame sizes are listed.
 - Any non-standard frame width and/or height is priced as the next larger size frame category.
 - Available sizes displayed above.
- Only available in 2" face with 2" or 4" face heads.
- Case Open Frames are not available.
- New Masonry anchors (Masonry T) and Existing Masonry anchors (installed Tube and Strap with punch and dimple) are required and will be added to the end of your order based on opening size and wall construction. See Steelcraft tech data for correct usage.
- *Anchorage choice with an engineering request; extended lead time.
- FBC EHPA Hurricane/Tornado Label can be added to ICC500 label for flush door assemblies only per FL41734.1. Securitech hardware N/A.

Standard Construction Options: Per leaf

GALVANNEALED A-60 STEELN/C

4" FACE HEAD: **Thru 4'0"** **Over 4'0"**
\$57 \$81

MARK NUMBERS.....N/C

DUTCH FRAMEnot available

COMMUNICATING FRAME.....not available

SPECIALPROFILE FRAMES.....not available

HOSPITAL STOPS.....not available

APPROVED ANCHORAGE (required in jambs, heads and sills):

- New Masonry (CMU block walls)..... **Per prep**
- Jambs: Masonry-T jambs.....N/C
- Head (choose 1 type):
 - EMA head T&S anchor, P&D, factory install..... \$24.25 (order bolts as listed under Existing Masonry > T&S)
 - Lintel 2" wedge anchor assembly.....\$19.50
 - Lintel 4" wedge anchor assembly\$24.50
- Weld-in base anchor.....N/C
- New Concrete (poured in place or tilt-up)
 - Steel Embed Plates (plates by others) - T&S inst, no P&D....\$18.75
 - *Z anchor (full length per jamb, head, and sill) \$85
- Existing Masonry (concrete or CMU block walls)
 - T&S anchor, P&D, factory installation..... \$24.25
 - 5" Bolts for 2" face jambs and heads (Q326)..... \$20
 - 7.25" Bolts for 4" face heads (Q327 + Q325).....\$23.50
- Steel plates (by others) bolted to wall - T&S inst, no P&D\$18.75
 - Bolts: See above. If shorter needed, call for specs.
 - Frame welded to steel plates on site
- Anchoring to Structural Steel
 - Welded - T&S anchor (no P&D), factory install.....\$18.75
 - Bolted - T&S anchor, P&D, factory install..... \$24.25
 - 4" zinc-plated Bolt assy for 2" face \$17
 - 6" zinc-plated Bolt assy for 4" face heads\$27
 - See McMaster-Carr or call for specs on optional 5" zinc and 7" black-oxide bolts

4 SIDED FRAME:

- Add for sill section.....\$109
- Face weld frame.....\$226
- Full profile weld frame.....\$404

12 GAUGE HEAD REINFORCING CHANNELstandard

LABELED FRAMES : (NO CLOSER REINF)	Single	Pair
UL:	N/A	N/A
ITS/WHI: Metal label (no closer) *3, 1 1/2, or 3/4 hour	\$28	\$56
20 minute or smoke & draft	\$21	\$42
FM:	N/A	N/A
ICC500-2014 / FEMA 361/320 Label	N/C	N/C
FBC EHPA Hurricane/Tornado Label	\$21	\$42

*Glass lights rated up to 1-1/2 hours max
Refer to the Steelcraft Tech Data Manual for all labeled approvals.

Prices subject to change without notice.

Standard Hardware Options:

Per prep

SPECIAL VERTICAL HARDWARE LOCATIONS:

- Hinge and lockN/C

SURFACE MOUNTED CLOSERS / HOLDERS / STOPS:

- Surface Mounted Closers:
 - 14" strap installedN/C
(Specify regular or parallel)

• Approved models - LCN 4000T, 4010, 4010T, 4020, 4020T, 4030, 4030T, 4040XP, 4040XPT, 4050, 4110, 4110T

• Approved models - FALCON SC70 (heavy duty), SC80A, SC60A

• Concealed or semi-concealed (per template)..... not available

• ALLE Concealed or semi-concealed (per template)..... not available

• Surface Overhead Holder/Stopspecify reinf in available closer preps

• Approved models - GJ 79S (extra heavy duty), 70S, 90S, 81S
(79 series does not open 180° so application should be confirmed).

HINGES:

- 5" Universal in lieu of 4 1/2" UniversalN/C

• Approved models: IVES 3CB1, 3CB1HW, 3CB1NRP, 3CB1HWNRP, 3CB1SH, 3CB1HWSH, 5BB1, BB1HW, 5BB1NRP, 5BB1HWNRP, 5BB1SH, 5BB1HWSH, 5BB1WT, 5BB1HW WT

• Additional hinge prep \$21

• High frequency prep \$25

Continuous hinge (Full mortise only)

- No reinf. (blank jamb) N/C

- Full length reinf \$81

• Approved models - IVES Alum Geared: 112HD, 112XY, 224HD, 224XY

• Approved models - IVES Steel Pin & Barrel: 600, 700, 700CS, 705

• Approved models - IVES Electric: TW8, TWP

Standard Hardware Options:

Per prep

STRIKES:

- Von Duprin

• Vertical Rod reinf for 2-point: WS98/9927(F)N/C

• Rim and Vertical Rod reinf for 3-point: WS98/9957(F)N/C

- Schlage

• Vertical Rod reinf for 3-point: LM/LMV9300N/C

- Securittech

• Vertical Rod reinf for 52xx, 53xx, 54xx, 7L, 7T/C, 8L, or 8T/C Series (field drilled)N/C

• Securittech ATAR RB-100 Series with Schlage ND lockset. Bottom bolt uses HVL jamb boltN/C

• HVL HOVE bolt option jamb prep for all series (singles); HVL required for 7L, 7T, and ATAR RB-100 (holes field drilled)N/C

• Medeco 3 deadlocks \$177

- IVES

• SB360 Top and bottom surface bolts for inactive leafN/C

- Additional strikes not available

- Roller latch not available

Electrical Preps (Reviewed by engineering / not available in OEW):

• Power transfer units (i.e. EPT2, EPT10, etc) \$133

• Approved models - Von Duprin EPT2, EPT1

• Electric hinge prep \$53

• Auto OperatorsN/C (specify reinf in available closer preps)

• Approved models - LCN 9953 for pairs, 9542 for singles (must be mounted to exterior/storm side of storm shelter or safe room). MUST order 5" heavy weight hinges and high frequency hinge reinforcements.

• Electric door closerN/C (specify reinf in available closer preps)

• Approved models - LCN Sentronic 4040SE, 4310ME (may be mounted on interior or exterior side of shelter or safe room). 4040SE exterior side only.

• Door position switch (round 1/2" to 1" dia) \$53

• Approved models - Schlage 679-05, Sentrol 1078/1076 (mortised into the door hinge frame rabbet).

THRESHOLDS & GASKETING: no preps

• Approved models - ZERO (must not impede or affect the function of the opening or latching hardware).

NOTES:

1. Only approved models are allowed; for more information on approvals see Tech Data, tornado section.
2. Junction boxes provided with most electrical preps. Knockouts are designed to support 1/2" or 3/4" conduit.
3. Electrical preps will be reviewed by engineering and are not available in OEW.
4. Securittech approved options include 4pt stationary bolt in hinge jamb and door edge n/c (field drilled, no additional door or frame preps). Typ 54xx, 7x04, or 84xx when ordering hardware from Securittech.

Prices subject to change without notice.

INPACT™ DOOR SYSTEM PRICING

Door Width	L18	L16	T18	T16
UP TO 6'8" HIGH				
2'6" thru 3'0"	\$3,871	\$4,103	\$5,016	\$5,247
Over 3'0" thru 3'6"	\$4,067	\$4,288	\$5,211	\$5,432
Over 3'6" thru 3'8"	\$4,254	\$4,479	\$5,433	\$5,658
Over 3'8" thru 4'0"	\$4,440	\$4,671	\$5,654	\$5,885
UP TO 7'0" HIGH				
2'6" thru 3'0"	\$3,905	\$4,104	\$5,049	\$5,248
Over 3'0" thru 3'6"	\$4,115	\$4,333	\$5,259	\$5,477
Over 3'6" thru 3'8"	\$4,307	\$4,524	\$5,486	\$5,703
Over 3'8" thru 4'0"	\$4,499	\$4,715	\$5,713	\$5,929
UP TO 7'2" HIGH				
2'6" thru 3'0"	\$4,012	\$4,203	\$5,156	\$5,347
Over 3'0" thru 3'6"	\$4,149	\$4,377	\$5,293	\$5,522
Over 3'6" thru 3'8"	\$4,362	\$4,608	\$5,541	\$5,787
Over 3'8" thru 4'0"	\$4,576	\$4,838	\$5,789	\$6,052
UP TO 8'0" HIGH				
2'6" thru 3'0"	\$4,388	\$4,623	\$5,562	\$5,797
Over 3'0" thru 3'6"	\$4,555	\$4,776	\$5,729	\$5,950
Over 3'6" thru 3'8"	\$4,736	\$4,949	\$5,940	\$6,153
Over 3'8" thru 4'0"	\$4,917	\$5,123	\$6,151	\$6,357
UP TO 9'0" HIGH				
2'6" thru 3'0"	\$5,154	\$5,421	\$6,159	\$6,324
Over 3'0" thru 3'6"	\$5,219	\$5,533	\$6,368	\$6,635
Over 3'6" thru 3'8"	\$5,382	\$5,728	\$6,593	\$6,916
Over 3'8" thru 4'0"	\$5,544	\$5,923	\$6,818	\$7,197
UP TO 10'0" HIGH				
2'6" thru 3'0"	\$5,293	\$5,567	N/A	N/A
Over 3'0" thru 3'6"	\$5,509	\$5,847	N/A	N/A
Over 3'6" thru 3'8"	\$5,730	\$6,081	N/A	N/A
Over 3'8" thru 4'0"	\$5,950	\$6,315	N/A	N/A

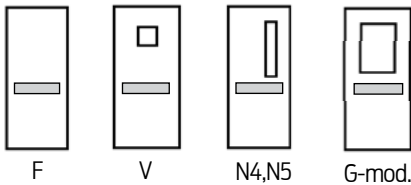

NOTES:

1. Minimum size 2'6" x 6'8" maximum size 4'0" X 10'0"
2. When ordering INPACT™ Door Systems, the INPACT™ System Order Form must be used (download available online)
3. Warranty for INPACT™ Door System is based upon component warranties. Doors are one year from date of delivery
4. Half glass G light doors require a modified glass to accommodate the exit device location. Refer to the Tech Data Manual for glass size details
5. GRAINTECH™ option add per Custom Door Options section
6. See L or T-Series Doors for Prep Only (hardware ordered separately)
7. INPACT™ System must be ordered with installed exit device. Other hardware ships with the door and is optional.

The Standard INPACT™ Door System includes:

- DOOR CONSTRUCTION:** Cold-rolled steel, honeycomb core
- STANDARD DOOR FINISH:** Factory applied primer
 - Finish Paint and GRAINTECH™ available... refer to Custom Door Options section
- EXIT DEVICE:** Factory-installed INPACT recessed fire-rated exit device model 9447EO-F, LBR (less bottom rod), see options on next page
- EXIT FINISH:** US26D Satin Chrome, see options next page.....\$116
- PACKAGED HARDWARE OPTIONS:** Closer, Hinge, Magnetic hold open, and electronic options Shipped with Door, see the next page
- FIRE RATING:** (also see Options on the next page)
 - Single: up to 3 hr using 94/95/75-F
 - Pair same swing: up to 90 min
 - Double egress: up to 90 min to 8'
 - Double egress with astragal: up to 3h to 8', 90 min to 9'
- ASTRAGAL (double egress) or WIDE INACTIVE (same swing pair)\$95**
- GLASS LIGHTS** Designer Trim for 1/4" or 1/2" thick glass (1/4" standard):
 - Standard size V, N4 or N5 \$220
 - Standard size G (see note 4) not available
 - Non-standard size V, N, G (G N/A with T Series) \$265
 - Non-standard size for labeled doors
 - Special size and glass thicknesses see page 66
- LIGHT / LOUVER CUTOUTS ONLY (per cutout):**
 - Non-labeled cutout only \$83
 - Labeled and non-labeled cutout with channels \$162
- NON-STANDARD SIZE WIDTHS and HEIGHTS** price as next larger size door
- CORE MATERIAL OPTIONS:**
 - Honeycomb Standard
 - Polystyrene \$38
 - Polyurethane (non-labeled only) \$188
 - Temperature Rise Core (T Series) Standard (T18/T16)
- GALVANNEALED STEEL (A-60) \$102**
- GALVANIZED STEEL (G-90) \$407**
 - 18, 16 or gauge only
 - Maximum 3'8" x 10'0" door size
- EDGE SEAM CONSTRUCTION OPTION:**
 - LF (Filled) \$112
 - LW (Welded) not available
- UNDERCUT / FLOOR CLEARANCE:**
 - 3/8" standard used with Concealed Vertical Rods N/C
 - 3/4" standard used with Mortise Locks N/C
 - Under 3/8" price as next larger size
- TOP CAPS FACTORY INSTALLED:**
 - Screw-in cap (top or bottom) \$24
- MARK NUMBERS** N/C

LABELED SYSTEMS : (NO CLOSER REINF)	Per Leaf
UL: Metal label (no closer) Hardware - Fire Exit Hardware	
· 3, 1 1/2, 1 or 3/4 hour	\$46
· 20 minute	\$19
ITS/WHI:	N/A
FM:	N/A

Refer to the Steelcraft Tech Data Manual for all labeled approvals.

Prices subject to change without notice.

VON DUPRIN EXIT DEVICE OPTIONS

(per function and finish color, note price of 94/9547 EO 628 is built into the base price table and reduced from other selectable exit options):

- 94/9547 Exit Device with Concealed Vertical Rods - Top and bottom Rod or LBR (Less Bottom Rod)
- Trim and Control matches Exit finish and is included in price as shown

	Brt Brass / Pol Chr	Satin Brass	Satin Bronze	Satin Chrome	Anod Alum	Duran Dk Brz	Sat Chr Antimic			
Function	US3 / US26 605 / 625	US4 606	US10 612	US26D 626	US28 628	313AN 710	US26D-AM 626-AM	Trim	Control	Description
EO	\$427	\$247	\$149	\$125	\$0	\$49	\$211	N/A	N/A	Exit only. No outside trim plate
DT	\$1,152	\$805	\$862	\$830	\$705	\$754	\$916	550DT	N/A	Dummy trim (pull)
L	\$1,384	\$1,070	\$1,075	\$985	\$860	\$936	\$1,071	940L	N/A	Lever, Key locks/unlocks
L-BE	\$1,384	\$1,070	\$1,075	\$985	\$860	\$936	\$1,071	940L-BE	N/A	Lever, Blank escutcheon, Always operable
*L-DT	\$1,483	\$1,169	\$1,174	\$1,084	\$959	\$1,035	\$1,170	940L-DT	N/A	Rigid lever, Blank escut, pull when dogged
TL	\$2,154	\$1,606	\$1,864	\$1,761	\$1,636	\$1,685	\$1,847	550DT	376T	Thumb Turn, Cylinder prep, 550DT pull
TL-BE	\$2,104	\$1,555	\$1,814	\$1,711	\$1,586	\$1,635	\$1,797	550DT	376T-BE	Turn thumb lever without key cylinder prep
TL-OP	\$1,429	\$1,049	\$1,151	\$1,056	\$931	\$980	\$1,142	N/A	376T	TL turn lever without 550DT pull

*Panic only; N/A Fire exits

Other device options and notes:

- 94/9548 Bottom Latch Assembly. Used with longer latchbolt rod, needed for special floor clearances over 3/8" (Per Leaf) \$314
- Fire rated adder (Per 94/9547 or 94/9548 Exit Device) \$362
- A/X Accessible (ADA 5lb opening force, top/bottom rod only) \$80
- LBR deduct \$159
- AFL N/C
- L may be field-converted to L-NL N/C

• 94/9575 MORTISE EXIT DEVICE OPTIONS

	Brt Brass / Pol Chr	Satin Brass	Satin Bronze	Satin Chrome	Anod Alum	Duran Dk Brz	Sat Chr Antimic			
Function	US3 / US26 605 / 625	US4 606	US10 612	US26D 626	US28 628	313AN 710	US26D-AM 626-AM	Trim	Control	Description
EO	\$920	\$740	\$642	\$590	\$465	\$542	\$676	N/A	N/A	Exit only. No outside trim plate
DT	\$1,645	\$1,297	\$1,355	\$1,295	\$1,170	\$1,247	\$1,381	550DT	N/A	Dummy trim (pull)
L	\$1,877	\$1,563	\$1,568	\$1,450	\$1,325	\$1,429	\$1,536	940L	N/A	Lever, Key locks/unlocks
L-BE	\$1,876	\$1,563	\$1,568	\$1,450	\$1,325	\$1,429	\$1,536	940L-BE	N/A	Lever, Blank escutcheon, Always operable
*L-DT	\$1,976	\$1,662	\$1,667	\$1,549	\$1,424	\$1,528	\$1,635	940L-DT	N/A	Rigid lever, Blank escut, pull when dogged
NL	\$1,645	\$1,297	\$1,355	\$1,295	\$1,170	\$1,247	\$2,340	550DT	N/A	Dummy Pull with key cylinder prep

*Panic only; not available for Fire exits

Other device options and notes:

- Fire rated adder (Per 94/9575 Exit Device) \$384
- AFL N/C
- L may be field-converted to L-NL N/C

LCN CLOSER OPTIONS (per model and powder coated finish color):

	Aluminum	Statuary Bronze	Light Bronze	Tan	Black	Dark Bronze	Satin Brass
Closer	689	690	691	692	693	695	696
4040XP	\$675	\$675	\$675	\$675	\$675	\$675	\$675
4000T (4003T/4004T)	\$726	\$726	\$726	\$726	\$726	\$726	\$726

Other device options:

- ST-2967 for ADA 4040XP cylinder with 4000T closer (verify closing force pressure is sufficient, especially in fire rated openings) \$35
- ST-2575 (or ST2481 EDA option) for System Set D4 long arm to support double egress wide throw hinge with 4040XP close \$121
- Metal Cover to replace Standard Cover \$23
- Omit Closer N/C

Screw options

- Standard defaults: WMS - Wood & Machine Screws (for 4000T); SRT - Self Reaming & Tapping (for 4040XP) N/C
- TBWMS - Thrubolt & TORX Wood&Machine N/C
- TORX - Torx Machine Screws \$16
- TBTRX - Thrubolt & TORX Machine \$16
- MTBMS - Metric Metal TB Machine Screws (for metal covers only) N/C
- MWMS - Meteric Metal & Wood Screws (for metal covers only) N/C
- Standard Full width closer reinforcement N/C (deducted from door base price but charged on invoice) \$72

Prices subject to change without notice.

IVES HINGE OPTIONS (per model and finish color):

- **Full Mortise Continuous Hinges** (per hinge, cut to length), Non-standard size lengths price as next larger size hinge, e.g. 84" price as 85")

	83" (for 7' door)			85"			95"			120" (119" for XY)		
Stainless Pin & Barrel (Satin color)	630/US32D			630/US32D			630/US32D			630/US32D		
700: Full mortise	\$743	-	-	\$861	-	-	\$891	-	-	\$1,052	-	-
711BSC: Beveled door swing clear	\$834	-	-	\$985	-	-	\$957	-	-	\$1,200	-	-
Anodized Aluminum Geared HD	Satin 628/US28	Dark Bronze 710/313AN		Satin 628/US28	Dark Bronze 710/313AN		Satin 628/US28	Dark Bronze 710/313AN		Satin 628/US28	Dark Bronze 710/313AN	
224HD: Full mortise	\$255	\$318	-	\$255	\$334	-	\$314	\$424	-	\$495	\$666	-
Anodized Aluminum Geared XY	Satin 628/US28	Dark Bronze 710/313AN	Black 711/315AN	Satin 628/US28	Dark Bronze 710/313AN	Black 711/315AN	Satin 628/US28	Dark Bronze 710/313AN	Black 711/315AN	Satin 628/US28	Dark Bronze 710/313AN	Black 711/315AN
224XY: Full Mortise	\$318	\$398	\$457	\$318	\$398	\$457	\$389	\$513	\$589	\$628	\$804	\$925
040XY: Wide Throw	\$574	\$751	\$864	\$574	\$751	\$864	\$707	\$901	\$1,036	\$1,131	\$1,449	\$1,666
041XY: Swing Clear	\$636	\$839	\$965	\$636	\$839	\$965	\$760	\$1,007	\$1,158	\$1,166	\$1,511	\$1,737

Standard Continuous hinge reinforcement N/C (deducted from door base price but charged on invoice std) \$85

- **Pocket Pivots** (per hinge, multiply by 3 for doors under 7'6"; Multiply by 4 for door openings 7'6 thru 10', per door)

	Satin 630/US32D
91105F: Pocket Pivot	\$611

Stainless Base

- **Architectural Ball Bearing Hinges**

(for 1-1/2 pair per door. Price for 2 pair when ordering 7'6 thru 10' door opening height by multiplying the price below by 1.33)

Heavyweight Butt Hinges	Satin 630/US32D	Satin Chrome 652/US26D	Satin Chrome 626/US26D	Heavyweight Swing Clear Butt Hinges	Satin 630/US32D	Satin Chrome 652/US26D
5BB1HW 4.5x4.5	\$97.80	\$47.30	\$89.10	5BB1HWBSC 4.5"	\$202.40	\$112.60
5BB1HW 5x4.5	\$114.40	\$54.40	\$121.60	5BB1HWBSC 5"	\$242.80	\$112.60

Stainless Base Steel Base Brass Base

Stainless Base Steel Base

Other hinge options:

Screws pack options:

- SECHM - Security Screws (Option for all continuous hinges) \$55
- TF - Thread Forming (Option for all aluminum geared continuous hinges) \$29
- Security Screws (Option for Architectural hinges) \$35
- HT - Hospital tip - Pin & Barrel hinges (each) \$186
- HT - Hospital tip - Butt hinges (each) \$18
- Hinge cut to length N/C
- Omit Hinge N/C

LCN MAGNETIC HOLDER OPTIONS (per model and finish color):

	Aluminum 689	Dark Bronze 695
SEM 7850	\$512	\$512

• Omit Magnetic Holder N/C

ELECTRICAL OPTIONS

- LX \$323
- QEL \$1,187
- QEL LX \$1,510
- Door Prep for EPT \$129
- Continuous Hinge EPT prep \$164
- Power Transfer (per model and painted finish color):

	Aluminum 689/SP28	Dark Bronze 695/SP313
EPT2	\$634	\$634
EPT10	\$673	\$673

NOTE: Refer to INPACT order form and Tech Data for Application System Sets and all options.

Prices subject to change without notice.

GLASS LIGHT LOCATIONS

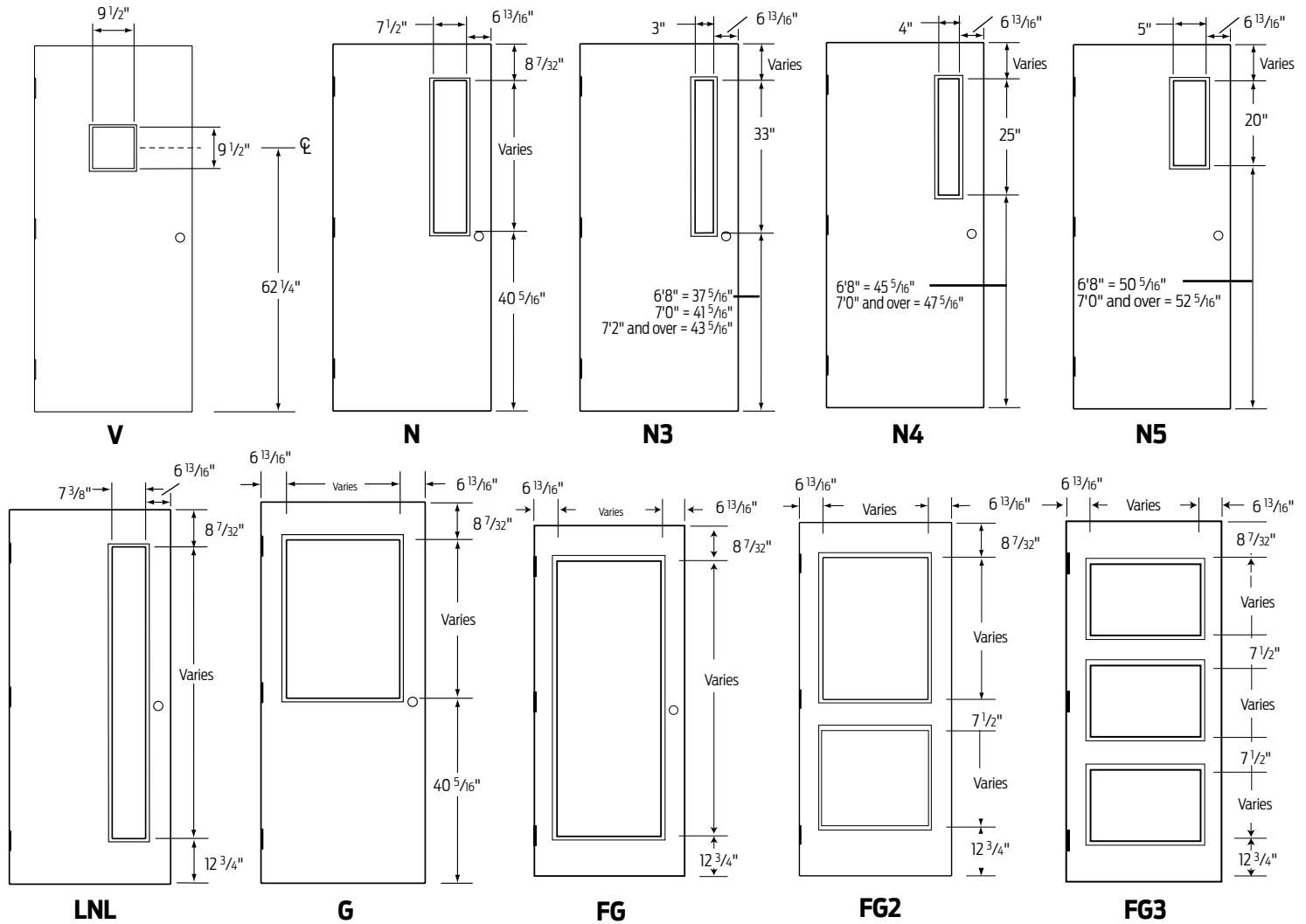

NOTES:

1. Glass light size and locations shown are Steelcraft standards
2. Dimensions shown are exposed glass sizes
3. See Tech Data Manual for additional information and glass cutting sizes
4. Glazing tape or putty glazing may be used
5. Glass cutting size equals exposed glass dimensions plus 1 3/16"
6. All FG doors ordered as cutout only will be priced and supplied with perimeter channels
7. Dimensions vary on special height doors
8. Exit devices hardware may interfere with the Steelcraft standard N, N3 and G glass lights
Ordering options:
 - a. Order door with special glass light
 - b. Order door with special exit device hardware location
9. Not applicable to A14-Series. Refer to Steelcraft Tech Data Manual.

Prices subject to change without notice.

UNIT PRICE PER LEAF

NON-STANDARD LIGHT SIZES USING DEZIGNER TRIM

Applicable door series: labeled and non-labeled L, SL, B, T and H-Series

- VS, NS or GS (N/A on T-Series). Special LNL sizes are supported by NS.
 - Non-labeled \$265
 - Labeled \$287

Applicable door series: labeled and non-labeled L and A14-Series

- FGS (not available labeled) \$407
- FG2S \$609
- FG3S \$949

Applicable door series: non-labeled H-Series

- FGS (not available labeled) \$450
- FG2S (not available labeled) \$678
- FG3S (not available labeled) \$1,013

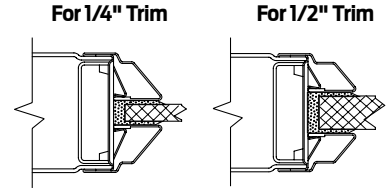

MULTIPLE LIGHTS USING DEZIGNER TRIM

Applicable door series: labeled and non-labeled L-Series

- Standard light sizes, add per additional light type V, N3, N4 or N5 \$220
- Non-standard light sizes, add per additional light type \$265

GLASS LIGHTS USING OVERLAPPING STEEL TRIM (FOR 1/4" THRU 1" GLASS)

Applicable door series: labeled and non-labeled L, SL, B, T, CE, H and HE-Series

- Any standard or non-standard size V, N, N3, N4, N5, G or LNL \$453
 - Any standard or non-standard size FG L, H* and A14-Series only \$605
 - Any standard or non-standard size FG2 L, H* and A14-Series only \$778
 - Any standard or non-standard size FG3 L, H* and A14-Series only \$1,037
- * Use 1" Trim only on H-Series doors (Labeled)

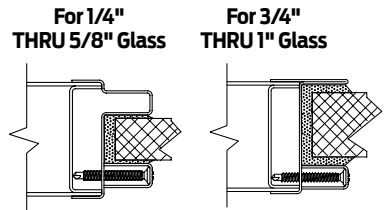

GLASS LIGHTS USING FLUSH MOUNTED STEEL TRIM (FOR 1/4" OR 1" GLASS)

Applicable door series: labeled or non-labeled L, SL, B and T-Series only (1/4" glass)

- Any standard or non-standard size V, N3, N4, N5, G or LNL \$453
- Any standard or non-standard size FG L-Series only \$591
- Any standard or non-standard size FG2 L-Series only \$794
- Any standard or non-standard size FG3 L-Series only \$887

Applicable door series: labeled or non-labeled L, SL, B, and T-Series only (1" glass)

- Any standard or non-standard size V, N3, N4, N5, G or LNL \$563
- Any standard or non-standard size FG L-Series only \$700
- Any standard or non-standard size FG2 L-Series only \$887
- Any standard or non-standard size FG3 L-Series only \$1,037

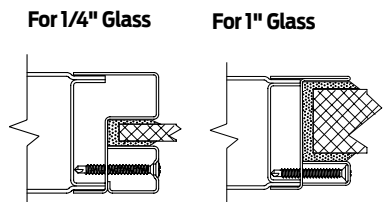

NOTES: Standard size V, N3, N4 and N5 may be placed at a non-standard location at no extra charge.
Not available on 14 GA doors

CIRCULAR / OVAL LIGHT CUTOUTS ONLY

Applicable door series: see below

- Cutout only, no perimeter channel L-Series \$316
- Cutout with perimeter channel L and B-Series \$388

Circular or Oval Cutout

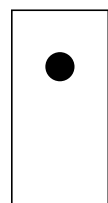

NOTES:

1. Perimeter channels are required for all labeled doors and B-Series doors.
2. Consult factory for minimum stile and rail requirements.
3. Non-standard or Special light sizes are any that vary from elevations shown on the previous Standard Light Sizes page.
Acknowledged pricing and naming may vary between VS, NS, and GS.

Prices subject to change without notice.

FLUSH DOORS: L, T and H-SERIES

Type	Door Width	Factory Stained	Prime Painted
Single Door	Up to 3'4"	\$859	\$119
	Over 3'4" up to 4'0"	\$913	\$143
Double Door	Up to 3'4"	\$1,718	\$238
	Over 3'4" up to 4'0"	\$1,826	\$286
Dutch door	Up to 4'0"	\$1,767	\$238
Transom panels	Up to 8'0" x 4'0" (1 3/4")	\$913	\$143

EMBOSSED PANEL: CE-18 and CE-16 SERIES (E6, HD2 and HD2A designs only)

Type	Door Width	Factory Stained	Prime Painted
Single Door	Up to 3'4"	\$1,042	\$119
	Over 3'4" up to 3'8"	\$1,093	\$143
Double Door	Up to 3'4"	\$2,084	\$238
	Over 3'4" up to 3'8"	\$2,186	\$286

NOTES:

1. Max. width for HD2A design is 3'4"

GLASS LIGHT OPTIONS

L-Series V, N3, N5, N4, NL, G, FG, FG2 and FG3:		
Door Width	Factory Stained	Prime Painted
Single doors: Up to 3'4" wide	\$989	\$146
Over 3'4" up to 4'0" wide	\$1,042	\$181
Double doors: Up to 3'4" wide	\$1,978	\$292
Over 3'4" up to 4'0" wide	\$2,084	\$362

CE-Series E4TL:		
Door Width	Factory Stained	Prime Painted
Single doors: Up to 3'4" wide	\$1,171	\$157
Over 3'4" up to 3'8" wide	\$1,224	\$195
Double doors: Up to 3'4" wide	\$2,342	\$314
Over 3'4" up to 3'8" wide	\$2,448	\$390

OTHER OPTIONS:

	Factory Stained	Prime Only
• Factory stained astragal (not EP4 material)	N/C	N/C
• Custom color set up charge - add per custom color	\$210	not available
• Prime stained steel dutch door shelf	not available	\$146

NOTES:

Factory Stained:

1. Not available on doors with Seam Filled Edges
2. L-Series doors available in 18 and 16 gauge, label or non-label with honeycomb, polystyrene or polyurethane core
3. T-Series doors available in 18 and 16 gauge with temperature rise core
4. CE-Series doors, available in 18 and 16 gauge, label or non-label with polystyrene core
5. H-16 Series doors, label or non-label with honeycomb, polystyrene, polyurethane or temperature rise core
6. Add prices shown above to the list price of a galvanized door.
7. Maximum height 10'0" 18 and 16 gauge
8. For extra quart of stain please specify on order and list price is \$120

Prime Painted (for field staining):

1. Not available on doors with Seam Filled Edges
2. Prime painted stainable doors are ready for staining and top coating labor and material by others
3. Add prices shown above to the list price of a galvanized door

Prices subject to change without notice.

DOORS - FINISH PAINT INFORMATION

Colors available on all, except B-Series, and Sizes; CRS or Galvannealed A-60.
Add two additional weeks to our Standard, 4-week, lead time.

NET PRICES

- **Set-up per color, per order**\$388 (net)
- **Price per leaf**\$78 (net)

NOTE: 1. Non-standard colors are available, consult Customer Care for pricing, lead time and request form to complete.

DOORS OMIT PRIME

- **Omit prime paint - Limits manufacturers warranty** \$83

Standard Colors

P2807 Rookwood Brown	P6128 Blonde
P2820 Downing Earth	P6130 Mannered Gold
P2821 Downing Stone	P6300 Burgundy
P2822 Downing Sand	P6314 Luxurious Red
P2837 Aurora Brown	P7598 Sierra Redwood
P2841 Weathered Shingle	P7603 Poolhouse
P2850 Chelsea Gray	P7622 Homberg Gray
P6006 Black Bean	P7623 Cascades
P6074 Spalding Gray	P7630 Raisin

ASTRAGALS - FACTORY ATTACHED**UNIT PRICE
PER LEAF**

- **Flat bar type** -14 gauge, surface applied tack welded to face of door\$107
(push side mount / pull side mount)
- **2 Piece astragal** - 2 piece astragal (price covers attachment to both leaves) \$205
(push side mount / pull side mount)
- **Z-Astragal** \$162

**NOTE:**

1. Applicable door series: labeled and non-labeled L, A14, B, T, CE-Series

AUTOMATIC DOOR BOTTOM

- **Auto door bottom prep (recessed channel)**\$218

NOTES:

1. 14 gauge channel installed
2. Edge prep not included

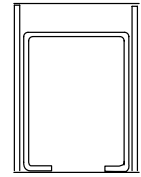
**TOP / BOTTOM CHANNEL APPLICATIONS**

- **Special depth (inverted top or bottom) recessed greater than 3/4" deep** \$177

NOTES:

1. Standard inverted 14 gauge top or bottom channel
2. Specify depth

• **Flush and filled 18 gauge channel**

- Screwed and Sealed into top channel\$138

• **Recessed 18 gauge channel (screwed-in)**

- Recessed 1/8" below top of door\$24

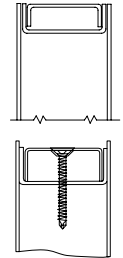
**MONO RAIL**• **Applicable door series: non-labeled L and B-Series only**

- Rectangular cutout and channel installed\$446

NOTE:

1. Consists of rectangular cutout in corner or edge of door L and B-Series: maximum size is 8" wide x 24" high

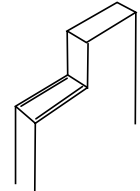
**DOOR VIEWER**

- Prep per template (max diameter = 3")\$29
- Not available in HD2/HD2A embossed panel designs

MAIL SLOT

- Cutout only\$83
- Cutout with channels\$162

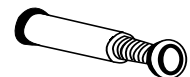
**12 GAUGE REINF. OPTIONS**

- 12 ga closure reinforcement \$69
- 12 ga continuous hinge reinforcement\$112

Prices subject to change without notice.

1 3/4" STAINLESS STEEL DOORS 18 GA & 16 GA

#4 BRUSHED SATIN OR 2B MILL FINISH, POLYSTYRENE CORE

LS-SERIES

DOORS

FLUSH - Type 304 SS		SEAMLESS DOOR EDGE		INTERLOCKING DOOR EDGE	
Width	Height	18 GA	16 GA	18 GA	16 GA
3' 0"	7' 0"	\$2,800	\$3,300	\$2,540	\$3,040
3' 0"	7' 6"	\$2,910	\$3,430	\$2,650	\$3,170
3' 0"	8' 0"	\$3,010	\$3,560	\$2,750	\$3,300
3' 6"	7' 0"	\$3,040	\$3,570	\$2,780	\$3,380
3' 6"	7' 6"	\$3,150	\$3,700	\$2,880	\$3,440
3' 6"	8' 0"	\$3,250	\$3,830	\$2,980	\$3,570
4' 0"	7' 0"	\$3,280	\$3,850	\$3,020	\$3,580
4' 0"	7' 6"	\$3,390	\$3,980	\$3,130	\$3,720
4' 0"	8' 0"	\$3,490	\$4,100	\$3,230	\$3,840

FLUSH - Type 316 SS		SEAMLESS DOOR EDGE		INTERLOCKING DOOR EDGE	
Width	Height	18 GA	16 GA	18 GA	16 GA
3' 0"	7' 0"	\$4,000	\$4,500	\$3,780	\$4,240
3' 0"	7' 6"	\$4,170	\$4,730	\$3,910	\$4,460
3' 0"	8' 0"	\$4,350	\$4,860	\$4,080	\$4,600
3' 6"	7' 0"	\$4,400	\$4,930	\$4,130	\$4,670
3' 6"	7' 6"	\$4,570	\$5,160	\$4,300	\$4,900
3' 6"	8' 0"	\$4,740	\$5,290	\$4,480	\$5,030
4' 0"	7' 0"	\$4,780	\$5,360	\$4,520	\$5,100
4' 0"	7' 6"	\$4,950	\$5,580	\$4,680	\$5,320
4' 0"	8' 0"	\$5,130	\$5,720	\$4,870	\$5,450

ELEVATION OPTIONS

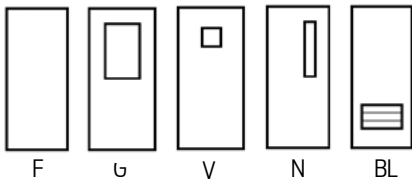

	Type 304 SS	Type 316 SS
FLUSH (F)		
HALF GLASS (G)	\$275	\$325
10"x10" VISION (V)	\$200	\$250
NARROW LITE (N)	\$200	\$250
BOTTOM LOUVER	\$625	\$825
TOP LOUVER	\$625	\$825

Note: Lite kits are based upon 3/16" - 5/16" thick glass by others.

CORE OPTIONS

Polystyrene (STY).....	N/C
Polyurethane (URE).....	\$300

TOP and BOTTOM END CHANNELS

Inverted U Channel.....	N/C
Close Top Flush (CTF).....	\$150
Close Bottom Flush (CBF).....	\$150
Cap & Seal Top (SEALT).....	\$200
Cap & Seal Bottom (SEALB).....	\$200

LABEL (Intertek WH)

ITS/WHI up to 3 hours.....	\$100
Dade County Label.....	see Custom Options

HARDWARE PREP OPTIONS

HINGES:	4 1/2" Reg Weight (45X).....	NC
	4 1/2" Extra Heavy (H45X).....	NC
	5" Extra Heavy (H50X).....	NC
	Continuous Hinge Reinforcement (CH).....	\$250 (drilling & tapping not included)
	Electric Hinge (EH).....	NC
	Cylindrical Lock (161).....	NC
	Cylindrical Deadlock (161D).....	NC
	Mortise Lock (MD).....	NC
	Mortise Deadlock (86D).....	NC
	Rim Exit Device (RE).....	NC
	Surface Vertical Rod Exit Device (SVRE).....	NC
	Concealed Vertical Rod Exit Device (CVRE).....	\$150
	Surface Closer (CL).....	NC
	Concealed Closer (CC).....	\$150
	Surface Overhead Stop / Holder (OS).....	NC
	Concealed Overhead Stop / Holder (COS).....	\$150
	Electric Power Transfer (EPT).....	\$50
	Conduit Raceway (COND).....	\$250
	4 7/8" ASA Strike (ASA).....	NC
	2 3/4" T Strike (T).....	NC
	2 3/4" Deadlock Strike (DL).....	NC
	3 1/2" Deadlock Strike (DLS312).....	NC
	Electric Strike (ES).....	\$150
	Flat Bar Astragal (AST).....	NC
	ASA Flush Bolts (FBX12).....	NC
	Auto Flush Bolts - Top Only (AFB1212).....	NC
	Auto Flush Bolts - Bottom Only (AFB12).....	NC
	Flushbolts Bottom Only (FBI2B).....	NC
	Surface Bolts (SB).....	NC

NOTES:

1. Stainless products and optional Dade county labels are produced off-site and ship separately. See Customer Options for hurricane listings available with Allegion hardware.
2. Please call to understand and verify freight.

For Custom Options

Call or email requests for net price quote prior to order submission with Job Name.

Customer Care: 1-877-671-7011 (ask for estimating)
e-mail: Steelcraftestimating@allegion.com

Prices subject to change without notice.

FLUSH DOOR PRICING - GALVANNEALED AND POLYSTYRENE

Door Width	SZ18 20-Pack	SZ18 10-Pack	SZ18 Singles
6'8" HIGH			
2'6" thru 3'0"	\$11,436	\$5,890	\$600
Over 3'0" thru 3'6"	\$13,354	\$6,877	\$701
Over 3'6" thru 4'0"	\$14,281	\$7,355	\$750
7'0" HIGH			
2'6" thru 3'0"	\$11,827	\$6,091	\$621
Over 3'0" thru 3'6"	\$13,741	\$7,077	\$721
Over 3'6" thru 4'0"	\$14,672	\$7,556	\$770



F

Typical Elevations

FLUSH DOOR PRICING - CRS AND HONEYCOMB

Door Width	SZ18 20-Pack	SZ18 10-Pack	SZ18 Singles
6'8" HIGH			
2'6" thru 3'0"	\$10,211	\$5,259	\$536
Over 3'0" thru 3'6"	\$12,128	\$6,246	\$637
Over 3'6" thru 4'0"	\$13,055	\$6,723	\$685
7'0" HIGH			
2'6" thru 3'0"	\$10,589	\$5,453	\$556
Over 3'0" thru 3'6"	\$12,506	\$6,441	\$657
Over 3'6" thru 4'0"	\$13,434	\$6,919	\$705

Standard Construction Options:

Per leaf

INACTIVE LEAVES (price pairs of doors as 2 single leaves):

Note: Due to hardware and astragal applications the inactive leaf options carry an up charge.

- Locking / latching hardware with Z-Astragal included in door charge. Hardware and Prep options..... \$95
 - Two (2) ANSI Flushbolt preps, one (1) 4 7/8" ANSI strike with Z-Astragal, or
 - Two (2) Surface Bolt reinf., one (1) 4 7/8" ANSI strike with Z-Astragal
- Wide inactive leaf not available

CORE AND MATERIAL: (see pricing tables above)

- Honeycomb & CRS will be default if not indicated

18 GAUGE STEELstandard**NON-STANDARD SIZE WIDTHS** ... price as next larger size door**UNDERCUT / FLOOR CLEARANCE** (3/4" standard)

- 3/4" or 3/8" only N/C

TOP CAPS (Loose) not included, available from 'Parts'**NOTES:**

1. **ALL construction and hardware options are shown on this page.**
2. Minimum size 2'6" x 6'8" / maximum size 4'0" x 7'0".
3. Available in 6'8" and 7'0" heights only.
4. For expanded options, please see SL and L-Series doors.

Standard Hardware, Preps and Options:**CLOSERS / HOLDERS / STOPS:**

- Surface Mounted:
- Closer – 20" reinf. only.....standard

HINGES:

- (3) Non-handed 4 1/2" square hingesstandard
- Special Vertical Hardware Locations N/C
- Additional hingesnot available
- Continuous hinge (no internal reinf.)..... N/C

LOCK / LATCH OPTIONS:

- Cylindrical Locks: 161 or 61L N/C
- Mortise Locks: 86ED N/C
- Special Vertical Hardware Locations..... N/C
- Additional locksnot available
- Blank locknot available

STRIKES:

- ASA (4 7/8" ANSI A115.1)standard
- Strike Prep in Steelcraft or alternate locations..... N/C
- Additional strikesnot available
- Blank strikenot available

EXIT DEVICE PREP:

- Rim Reinf. only \$48

LABELED DOORS:	Single	Pair
UL:	*not available	*not available
ITS/WHI: • 1 1/2 Mylar label	standard	standard
FM:	*not available	*not available
ASTM E-330 (Uniform Static Air Pressure)	*not available	*not available

*Refer to the Steelcraft Tech Data Manual for all labeled approvals.

Prices subject to change without notice.

TABLE OF CONTENTS

COORDINATORS..... 73
CLOSERS..... 73
FLUSHBOLTS..... 73
RESCUE HARDWARE..... 73
HINGES..... 74
HOLDERS AND STOPS..... 74
LOCKS AND STRIKES..... 75
PIVOTS..... 76
PUSH / PULLS..... 76

Prices subject to change without notice.

Prices subject to change without notice.

COORDINATORS / CLOSERS / FLUSHBOLTS / RESCUE HARDWARE

HARDWARE DEVICE	PREP PRICING		Illustration
	DOOR	FRAME	
COORDINATORS			
Face mounted strap reinf.	not applicable	\$28	
Soffit mounted full length reinf.	not applicable	\$66	

HARDWARE DEVICE	PREP PRICING		Illustration
	DOOR	FRAME	
CLOSERS - FLOOR MOUNTED CONCEALED			
Single acting Top prep in frame and door, bottom arm in door	\$514	\$128	
Single acting Intermediate (when specified)	\$172	\$105	
Double acting (includes aluminum nosing) Top prep frame and door, bottom arm in door	\$514	\$128	

HARDWARE DEVICE	PREP PRICING		Illustration
	DOOR	FRAME	
FLUSHBOLTS			
ANSI A115.4 manual or automatic (universal strike)	\$86	\$57	
Non-ANSI manual or automatic	\$351	\$96	

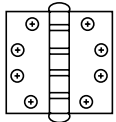
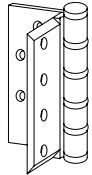
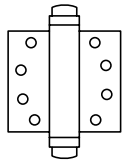
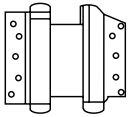
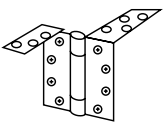
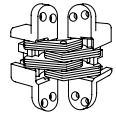
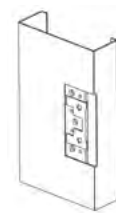
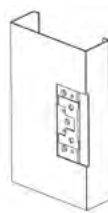

HARDWARE DEVICE	PREP PRICING		Illustration
	DOOR	FRAME	
RESCUE HARDWARE			
Top & Bottom Pivot, Emergency Release stop	\$514	\$279	
Double Lip strike (if combo release, use with pivot set on page 76)	not applicable	\$140	

Prices subject to change without notice.

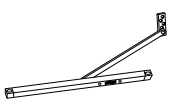
HARDWARE DEVICE	PREP PRICING		Illustration
	DOOR	FRAME	
HINGES			
Butt hinges:			
· 4" x 4" standard weight (L-Series, 20 gauge doors only)	\$56	\$56	
· Non-standard size / non-template prep 1 1/2 pair	\$294	\$219	
· Special heavy weight hinge in lieu of universal (4 1/2" or 5" heavy weight hinge for F & MU-Series)	\$23	\$23	
· Double mortise or over mortise (4 1/2" or 5" standard or heavy weight prep)	\$51	\$30	
· Surface mounted hinge (reinf. only)..... 1 1/2 pair 2 pair	\$111 \$148	\$75 \$100	
· Full jamb depth reinf. (universal 4 1/2" or 5")..... thru 8 7/8" (per prep) 9" thru 20"	not applicable not applicable	\$50 \$83	
Spring hinges, single-acting type:			
· 4 1/2" or 5" templated hinge	N/C	N/C	
· Non-template hinge 1 pair (reinf. only, no holes) 1 1/2 pair	\$214 \$295	\$108 \$162	
Spring hinges, double-acting type (prices include nosing applied to lock side of door):			
· 4 1/2" or 5" templated hinge	\$117	N/C	
· Non-template hinge	\$214	\$108	
· Reinf. only (no holes)	\$295	\$162	
NOTE: Special door size may be required for clearance.			
Anchor hinge (mortised and reinf.):			
· No drill holes, untapped	\$279	\$474	
· Factory drilled and tapped (frame must be welded, welding charges not included, price includes 5" hinge preps)	\$524	\$535	
Invisible hinge (SOSS)..... 1 1/2 pair (L-Series doors and F-Series frames)..... 2 pair	\$792 \$1,056	\$792 \$1,056	
Cased open frame hinge prep - add to cased open frame price:			
· Single door opening	not applicable	\$63	
· Double door opening	not applicable	\$126	
NOTE: For use with applied stop (not included).			

HARDWARE DEVICE	PREP PRICING		Illustration
	DOOR	FRAME	
HOLDERS AND STOPS			
· Concealed (track in door)	\$360	\$84	
· Surface reinf. in frame and door	\$62	\$26	
· ALLE concealed (track in door)	\$314	\$84	

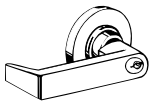
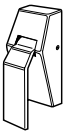
Prices subject to change without notice.

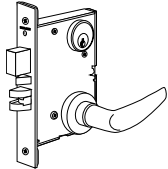
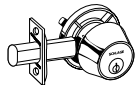
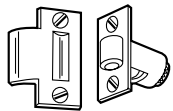
HARDWARE DEVICE	PREP PRICING		Illustration
	DOOR	FRAME	
LOCKS AND STRIKES			
· Government 161 - with thru-bolt trim holes	\$23	not applicable	
· Special backset - 161 and 61L (3 3/4" or 5")	\$48	not applicable	
· Hospital push / pull latch at any one location (special backset included, 5" standard)	\$56	not applicable	
· Push button access control lock	\$50	not applicable	
· Non-ANSI lip strike	not applicable	\$59	
· Non-ANSI mortise lock or Government 85 (prep at any one location)	\$216	not applicable	
· Unit / Mono / Rigid Lock	\$81	not applicable	
· Dummy trim reinf.	\$39	not applicable	
· Deadlock - at any one location cylindrical, mortise or tubular type (minimum 7" above or below standard lock prep)	\$59	\$21	
· ALLE Deadlock - at any one location	\$51	\$21	
· Roller latch prep in lock edge or top of door · 161 lock edge · ANSI strike preps	\$85 N/C N/C	\$43 N/C	
· Double acting door - lock or strike prep	\$180	not applicable	
· Exit alarm lock reinf. (reinf. only, cylinder holes not included)	\$60	not applicable	
· Magnetic / shear lock - mortised prep in top of door	\$314	\$201	
· Security jamb locks (lock prep in strike jamb, strike prep in door edge) · Jamb lock for 2" face frame Folger Adams NS400 Series or Brinks 3526	\$149	\$139	
· Jamb Lock for 8" face frame Folger Adams 120 Series or Airteq 9700 NOTE: Special frame profile and anchor charges are applicable.	\$149	\$697	
Cased open frame strike prep - add to cased open frame price: · Single door opening NOTE: For use with applied stop (stop not included).	not applicable	\$21	

Prices subject to change without notice.

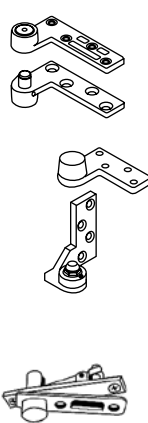
HARDWARE DEVICE	PREP PRICING		Illustration
	DOOR	FRAME	
PIVOTS			
<ul style="list-style-type: none"> • Single acting: <ul style="list-style-type: none"> • Mortised preps: <ul style="list-style-type: none"> • Top and bottom prep in door, top prep only in frame • Top and bottom prep in door and frame • Intermediate prep in door and frame per prep • Surface mounted: <ul style="list-style-type: none"> • Top, intermediate or bottom per reinf. • Double acting: <ul style="list-style-type: none"> • Top and bottom prep in door. Includes nosing on lock or hinge edge • Top prep only in cased open frame • Reinforcing pivot (for use in conjunction with standard 4 1/2" or 5" hinges): <ul style="list-style-type: none"> • Reinf. only for top pivot in face of door and frame • Pocket pivots (see notes below): <ul style="list-style-type: none"> • F-Series and DE-Series double egress 1 1/2 pair <ul style="list-style-type: none"> 2 pair • FE-Series double egress 1 1/2 pair <ul style="list-style-type: none"> 2 pair <p>Notes:</p> <ol style="list-style-type: none"> 1. Most pocket pivot preps require a frame face larger than 2". 2. Frames must be welded. Add applicable welding charges. 3. FE-Series double egress frames require special frame profile and special anchors charges. 	<p>\$344</p> <p>\$344</p> <p>\$172</p> <p>\$84</p> <p>\$436</p> <p>\$159</p> <p>\$564</p> <p>\$752</p> <p>\$564</p> <p>\$752</p>	<p>\$105</p> <p>\$210</p> <p>\$105</p> <p>\$84</p> <p>\$92</p> <p>\$84</p> <p>\$474 per jamb</p> <p>\$632 per jamb</p> <p>\$474 per jamb</p> <p>\$632 per jamb</p>	

HARDWARE DEVICE	PREP PRICING		Illustration
	DOOR	FRAME	
PUSH / PULLS			
<ul style="list-style-type: none"> • Flush pull - at any one location <ul style="list-style-type: none"> • Cutout and reinf. • Push / pulls <ul style="list-style-type: none"> • Plate reinf. • Bar reinf. • Light weight impact door reinf. (i.e., Eliason Easy Swing) 	<p>\$125</p> <p>\$39</p> <p>\$58</p> <p>not applicable</p>	<p>not applicable</p> <p>not applicable</p> <p>not applicable</p> <p>\$107</p>	

Prices subject to change without notice.

TABLE OF CONTENTS

LINEAL INCH STICK PRICING 78
 F16 and FT16 Series 78
 F14 and FT14-Series 79
 Cut and notch options 80
 Cut, notch and weld options 81
 Options (construction and hardware) 82

STICK LENGTHS (TSF PARTS) 83
 TSF Nomenclature 83
 F16 and FN16-Series 85
 F14 and FN14-Series 87
 Options (construction and hardware) 89

TRANSOM FRAMES WITHOUT TRANSOM BARS 90
 F16 and FN16-Series 90
 F14 and FN14-Series 91
 DW16 and MU16-Series 92

BORROWED LIGHT FRAMES 93
 F16-Series 93
 F14-Series 94
 MU/DW16-Series 95
 MU/DW14-Series 96

LAMINATED TRANSOM PANELS 97
 1 3/4" L-Series, fixed or removable 97

Prices subject to change without notice.

OPEN SECTION

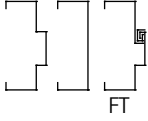
Frame Section	Description	3" - 5 ⁷ / ₈ "		6" - 7 ⁷ / ₈ "		8" - 9 ⁷ / ₈ "		10" - 11 ⁷ / ₈ "		12" - 14 ³ / ₄ "	
		CRS	GALV	CRS	GALV	CRS	GALV	CRS	GALV	CRS	GALV
	2" face only	\$1.36	\$1.61	\$1.47	\$1.63	\$1.87	\$2.04	\$2.23	\$2.50	\$2.71	\$2.98
	1" thru 4" face	\$1.81	\$2.02	\$1.96	\$2.13	\$2.49	\$2.68	\$2.92	\$3.13	\$3.56	\$3.73
	Over 4" face	Use sill section pricing									
	FT 2" face	-	\$5.98	-	\$6.09	-	\$6.50	-	\$6.94	-	*\$7.43
	FT 4" face	-	\$7.17	-	\$7.31	-	\$7.80	-	\$8.33	-	*\$8.92

CLOSED SECTION (MULLIONS)

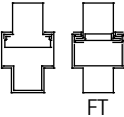
Frame Section	Description	3" - 5 ⁷ / ₈ "		6" - 7 ⁷ / ₈ "		8" - 9 ⁷ / ₈ "		10" - 11 ⁷ / ₈ "		12" - 14 ³ / ₄ "	
		CRS	GALV	CRS	GALV	CRS	GALV	CRS	GALV	CRS	GALV
	2" face only	\$3	\$3.34	\$3.42	\$3.78	\$3.81	\$4.09	\$4.45	\$4.96	\$5.33	\$5.84
	1" thru 4" face	\$3.90	\$4.19	\$4.51	\$4.69	\$5.01	\$5.06	\$5.81	\$6.17	\$6.65	\$7.22
	Over 4" thru 8" face	\$4.98	\$5.21	\$5.66	\$5.87	\$6.13	\$6.31	\$6.96	\$7.72	\$8.31	\$8.74
	Over 8" thru 12" face	\$5.34	\$5.58	\$6.06	\$6.27	\$6.57	\$6.76	\$7.45	\$8.26	\$8.88	\$9.35
	FT 2" face	-	\$10.63	-	\$10.84	-	\$11.56	-	\$12.35	-	*\$13.21
	FT 4" face	-	\$12.76	-	\$13	-	\$13.88	-	\$14.82	-	*\$15.86

SILL SECTION

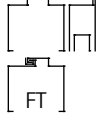
Frame Section	Description	3 ³ / ₄ " - 5 ⁷ / ₈ "		6" - 7 ⁷ / ₈ "		8" - 9 ⁷ / ₈ "		10" - 11 ⁷ / ₈ "		12" - 14 ³ / ₄ "	
		CRS	GALV	CRS	GALV	CRS	GALV	CRS	GALV	CRS	GALV
	4 ¹ / ₈ - 8 ¹ / ₈ " face	-	\$3.59	-	\$4.33	-	\$4.66	-	\$4.98	-	\$5.51
	8 ¹ / ₄ - 16 ¹ / ₈ " face	-	\$4.08	-	\$4.70	-	\$4.97	-	\$5.62	-	\$6.24
	FT 4 ¹ / ₈ - 6" face	-	\$10.21	-	\$10.40	-	\$11.10	-	\$11.87	-	*\$12.69

NOTE: Sill sections are available in galvanized only.

CORNER POSTS AND FILLER PLATES

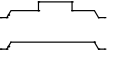
Frame Section	Description	3 ³ / ₄ " - 5 ⁷ / ₈ "		6" - 7 ⁷ / ₈ "		8" - 9 ⁷ / ₈ "		10" - 11 ⁷ / ₈ "		12" - 14 ³ / ₄ "	
		CRS	GALV	CRS	GALV	CRS	GALV	CRS	GALV	CRS	GALV
	2-way or 3-way corner post (4 ³ / ₄ " min.)	\$5.71	\$5.99	\$6.03	\$6.27	\$6.30	\$6.59	\$7.34	\$7.63	\$8.69	\$8.88
	Filler plates - weld-in with or without stop	\$1.51	\$1.69	\$1.67	\$1.84	\$1.77	\$1.95	\$1.96	\$2.12	\$2.38	\$2.56
	with stop only	\$2.01	\$2.17	\$2.07	\$2.25	\$2.12	\$2.30	\$2.35	\$2.51	\$2.45	\$2.62

NOTES:

- Jamb Depths over 14³/₄" thru 20"
 - Open section multiply 12" thru 14³/₄" column by 1.25
 - Closed section multiply 12" thru 14³/₄" column by 1.25
- See special profile Options page for MU profile Pricing.
- G-90 galvanize - multiply "GALV" price by 1.25 (maximum height 120")
- Sill sections 16¹/₄" thru 18" face, multiply price by 1.6
 - MU-Series sill, 4" face max
- FT Thermal Break sticks use typical cut, notch, and weld options on the following pages. Special preps and anchors used to maintain thermal break. Partial side lights priced as closed section, supplied as open section with welded-in filler plate.
 - Max opening 9'11" typ. • No single rabbet, special profiles, special angles, UL labels, 12 ga heads, high frequency preps, hospital stops. KD or Face weld only. Call for engineering detail requests. See tech data for details.
- *FT Thermal break sticks 5-3/4" thru 12-3/4" JD

Prices subject to change without notice.

OPEN SECTION

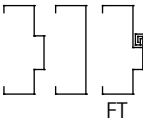
Frame Section	Description	3" - 5 ⁷ / ₈ "		6" - 7 ⁷ / ₈ "		8" - 9 ⁷ / ₈ "		10" - 11 ⁷ / ₈ "		12" - 14 ³ / ₄ "	
		CRS	GALV	CRS	GALV	CRS	GALV	CRS	GALV	CRS	GALV
	2" face only	\$1.60	\$1.87	\$1.84	\$2.02	\$2.32	\$2.52	\$2.62	\$2.80	\$3.23	\$3.48
	1" thru 4" face	\$2.11	\$2.37	\$2.29	\$2.50	\$2.95	\$3.12	\$3.30	\$3.47	\$4.16	\$4.34
	Over 4" face	Use sill section pricing									
	FT 2" face	-	\$6.30	-	\$6.54	-	\$7.05	-	\$7.34	-	*\$8.01
	FT 4" face	-	\$7.57	-	\$7.85	-	\$8.46	-	\$8.81	-	*\$9.61

CLOSED SECTION (MULLIONS)

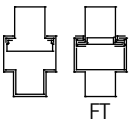
Frame Section	Description	3" - 5 ⁷ / ₈ "		6" - 7 ⁷ / ₈ "		8" - 9 ⁷ / ₈ "		10" - 11 ⁷ / ₈ "		12" - 14 ³ / ₄ "	
		CRS	GALV	CRS	GALV	CRS	GALV	CRS	GALV	CRS	GALV
	2" face only	\$3.48	\$3.76	\$4.23	\$4.46	\$4.61	\$4.84	\$5.24	\$5.53	\$6.22	\$6.50
	1" thru 4" face	\$4.46	\$4.73	\$5.37	\$5.60	\$5.83	\$6.04	\$6.72	\$6.96	\$7.73	\$8.40
	Over 4" thru 8" face	\$5.65	\$5.90	\$6.25	\$6.54	\$6.90	\$7.17	\$7.74	\$7.96	\$9.39	\$9.93
	Over 8" thru 12" face	\$5.80	\$6.16	\$6.72	\$7	\$7.39	\$7.63	\$7.90	\$8.08	\$9.89	\$10.07
	FT 2" face	-	\$11.64	-	\$12.09	-	\$13.04	-	\$13.56	-	*\$14.81
	FT 4" face	-	\$13.97	-	\$14.51	-	\$15.64	-	\$16.27	-	*\$17.78

SILL SECTION

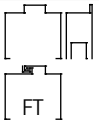
Frame Section	Description	3 ³ / ₄ " - 5 ⁷ / ₈ "		6" - 7 ⁷ / ₈ "		8" - 9 ⁷ / ₈ "		10" - 11 ⁷ / ₈ "		12" - 14 ³ / ₄ "	
		CRS	GALV	CRS	GALV	CRS	GALV	CRS	GALV	CRS	GALV
	4 1/8 - 8 1/8" face	-	\$4.25	-	\$5.12	-	\$5.74	-	\$6.14	-	\$6.79
	8 1/4 - 16 1/8" face	-	\$4.83	-	\$5.44	-	\$6.03	-	\$6.57	-	\$8.23
	FT 4 1/8 - 6" face	-	\$11.18	-	\$11.61	-	\$12.52	-	\$13.02	-	*\$14.22

NOTE: Sill sections are available in galvanized only.

CORNER POSTS AND FILLER PLATES

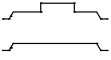



Frame Section	Description	3 ³ / ₄ " - 5 ⁷ / ₈ "		6" - 7 ⁷ / ₈ "		8" - 9 ⁷ / ₈ "		10" - 11 ⁷ / ₈ "		12" - 14 ³ / ₄ "	
		CRS	GALV	CRS	GALV	CRS	GALV	CRS	GALV	CRS	GALV
	2-way or 3-way corner post (4 ³ / ₄ " min.)	\$6.21	\$6.45	\$6.67	\$6.89	\$7.44	\$7.80	\$8.31	\$8.63	\$9.76	\$10.01
	Filler plates - weld-in with or without stop	\$1.75	\$1.98	\$1.87	\$2.08	\$1.98	\$2.21	\$2.33	\$2.56	\$2.93	\$3.14
	Filler plates - snap in	\$2.07	\$2.29	\$2.21	\$2.43	\$2.34	\$2.58	\$2.47	\$2.68	\$3.09	\$3.32

NOTES:

- Jamb Depths over 14 3/4" thru 20"
 - Open section multiply 12" thru 14 3/4" column by 1.25
 - Closed section multiply 12" thru 14 3/4" column by 1.25
- See special profile Options page for MU profile Pricing.
- G-90 galvanize - multiply "GALV" price by 1.25 (maximum height 120")
- Sill sections 16 1/4" thru 18" face, multiply price by 1.6
 - MU-Series sill, 4" face max
- FT Thermal Break sticks use typical cut, notch, and weld options on the following pages. Special preps and anchors used to maintain thermal break. Partial side lights priced as closed section, supplied as open section with welded-in filler plate.
 - Max opening 9'11" typ. • No single rabbet, special profiles, special angles, UL labels, 12 ga heads, high frequency preps, hospital stops. KD or Face weld only. Call for engineering detail requests. See tech data for details.
- *FT Thermal break sticks 5-3/4" thru 12-3/4" JD

Prices subject to change without notice.

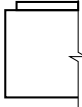
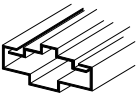
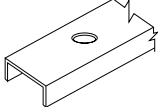
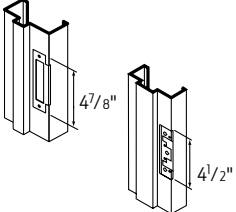
The following prices are to be used for frame elevations that are to be cut and notched by Steelcraft.
Welding charges are not included in the prices shown.

MITERED CORNER – OPEN SECTION:		Per end		
<ul style="list-style-type: none"> • Cut on a 45° angle..... \$14 • Corner tabs or clips are not included on saw miter material 				
NOTCHED – OPEN SECTION:				
<ul style="list-style-type: none"> • Square end cut and notch for butt welding thru 4" face..... \$14 				
NOTCHED – CLOSED SECTION:				
<ul style="list-style-type: none"> • Square end cut and notch for butt welding..... \$19 				
NOTCHED – SILL SECTION:				
<ul style="list-style-type: none"> • Square end cut and notch for butt welding over 4" face..... \$14 				
FILLER PLATES INSTALLED OPEN SECTION:		Per length		
<ul style="list-style-type: none"> • Square end, cut and notched and tackwelded thru 36"..... \$46 • over 36"..... \$68 				
GLAZING BEADS:				
NOTES:				
<ul style="list-style-type: none"> 1. Beads are not included in stick section pricing. They may be ordered from the Parts Section in stick lengths..... not available 				
HARDWARE PREP:		Per strike		
<ul style="list-style-type: none"> • 4 7/8" ASA or 2 3/4" CYL strike prep..... \$21 				
<ul style="list-style-type: none"> • 4 1/2" x 4 1/2" or 5" hinge prep..... \$21 	Per hinge			
NOTES:				
<ul style="list-style-type: none"> 1. Prices are for standard hinge and strike prep in an open or closed section 2. For special hardware preps, refer to hardware Options page 				
SPECIAL ANGLE MITER OR NOTCH:		Per setup		
<ul style="list-style-type: none"> • Setup charge..... \$872 				
NOTES:				
<ul style="list-style-type: none"> 1. For any frame requiring a special angle end cut other than 45° or 90° 2. This set-up charge is for each frame or multiple like frames of the same jamb depth requiring a different miter or notch angle 				
PARTIAL SIDE LIGHT NOTCH:		Per piece		
<ul style="list-style-type: none"> • Add to closed section price F-Series only..... \$32 				

Prices subject to change without notice.



LINEAL INCH STICK PRICING

FACTORY ASSEMBLY AND WELD

CUT, NOTCH and WELD OPTIONS

STICKS

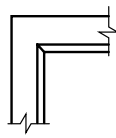
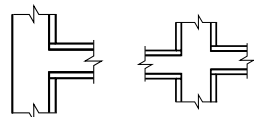
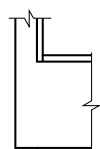
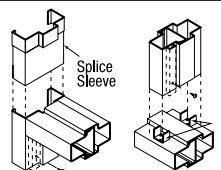
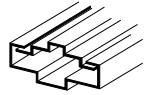
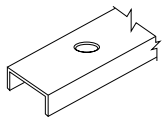
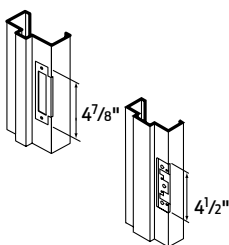
The following prices are to be used for frame elevations that are to be cut, notched and welded by Steelcraft. The units are shipped as a complete unit unless prohibited by shipping size limitations.

MITERED OR BUTTED CORNER JOINT:		Per joint	
· Face weld and finished smooth	1" to 2" face.....	\$87	
	Over 2" to 4" face.....	\$105	
· Complete profile	1" to 4" face.....	\$117	
MULLION "T" JOINT:			
· Face weld and finished smooth	1" to 2" face.....	\$87	
	Over 2" to 4" face.....	\$105	
	Over 4" to 12" face.....	\$158	
SILL-BUTTED CORNER JOINT:			
· Face weld and finished smooth	1" to 2" face.....	\$87	
	Over 2" to 4" face.....	\$105	
	Over 4" to 12" face.....	\$132	
	Over 12" to 18" face.....	\$158	
FIELD SPLICING JOINTS:			
· Open section.....		\$106	
· Closed section		\$106	
· Sill section		\$106	
FILLER PLATES INSTALLED IN OPEN SECTION:			
· Square end, cut and notched and tackwelded.....	thru 36".....	\$46	
at 12" on center and seams are visible	over 36".....	\$68	
GLAZING BEADS (Pre-cut and installed):		Per inch	
· 1", 5/8", or 7/16" wide		\$0.81/in	
NOTES: 1. 1" x 5/8" is standard unless specified. 2. Stick lengths may be purchased from Parts Section			
HARDWARE PREP:		Per strike	
· 4 7/8" ASA or 2 3/4" CYL strike prep.....		\$21	
		Per hinge	
· 4 1/2" x 4 1/2" or 5" hinge prep.....		\$21	
NOTES: 1. Prices are for standard hinge and strike prep in an open or closed section 2. For special hardware preps, refer to hardware Options page			
SPECIAL ANGLE MITER OR NOTCH:		Per setup	
· Set-up charge.....		\$872	
NOTES: 1. For any frame requiring a special angle end cut other than 45° or 90° 2. This set-up charge is for each frame or multiple like frames of the same jamb depth requiring a different miter or notch angle			
PARTIAL SIDE LIGHT NOTCH:		Per piece	
Add to closed section price F-Series only.....		\$32	

Prices subject to change without notice.

STANDARD CONSTRUCTION OPTIONS **Add per inch**

SPECIAL PROFILE (open or closed section):

- Special backbends
 ³/₈" minimum thru ¹/₈" maximum\$0.70
- MU..... \$0.17
- ³/₄" thru ¹/₄" high stops (⁵/₈" standard)\$0.70
- Center glazed, open or closed section.....\$1.16
- Special angle corner post\$0.70

MARK NUMBERS: N/C

REMOVABLE MULLION PREP\$82

TRANSOM PANEL PREP\$28

- Transom panels (refer Laminated Transom Panel page)

Per frame
Single Pair

UL LABELED FRAME \$21\$42

- Applies to factory welded frames only
- Factory labeled elevations must be shipped welded
- Does not include closer reinf.

12 GAUGE HEAD REINFORCING CHANNEL:

- 2" face only - full jamb depth\$192

LOOSE ANCHORS:

- Anchors must be ordered from the Parts Section

WELD-IN ANCHORS:

- Welded-in standard anchors: **Thru 9 1/8"** **Over 9 1/8"**
- Base N/C.....N/C
- Per jamb anchor\$7.....\$10
- EMA (pierce and dimple only)
- Per prep.....\$5.50.....\$11
- EMA (pierce, dimple, weld-in anchors with bolts)
- Per EMA anchor.....\$23.25.....\$46.50

HOSPITAL SANITARY STOPS (4", 5 1/2" and 6" high standard):

- Open sections: **Per prep**
- Double rabbet 45°.....\$108
- Double rabbet 90°\$108
- Closed sections:
- Double rabbet 45°.....\$113
- Double rabbet 90°\$113

STANDARD HARDWARE OPTIONS **Add per stick**

SPECIAL VERTICAL HARDWARE LOCATIONS:

- Hinge and strikeN/C

HINGES:

- 5" universal in lieu of 4 1/2"N/C
- High frequency prep (per hinge prep).....\$25
- Heavyweight hinge prep (per hinge prep)\$23

STRIKES:

- CYL strike in lieu of ASA N/C
- Deadlock strike (non-tip).....\$21
- Flushbolts:
 - Steelcraft reversible.....\$57
 - Standard (ANSI A115.4).....\$57
- Rim exit device reinf.\$29
- Vertical Rod reinf.\$29
- Vertical Rod Mortise strike (each)\$67

CLOSERS:

- Surface strap (14", 14 gauge)\$28
 (Specify regular parallel arm or top jamb)

NOTES:

1. Construction and hardware options shown on this page are applicable to linear inch pricing pages
2. 12 gauge perimeter, 2" to 4" face, multiply 14 gauge lineal price by 1.6
 - Closed section components are supplied as 14ga with matching profile
 - All frames have 3/4" high stops
 - Jamb depths 5" and under are unequal rabbet profile. All other jamb depths are equal rabbet profile.









































Prices subject to change without notice.































TSF PARTS LIST

Sticks are frame components used by the distributor to produce transom, transom / sidelight, sidelight and borrowed light frames. The components are cut to length, notched or mitered, assembled and welded into an assembly by the distributor to meet the requirements of the opening.

Sticks are commonly identified as TSF (Transom Sidelight Frame) sections. Each component has a unique TSF number that identifies it from another section. The frame jamb depth and gauge of steel are also used in the identification and ordering since the TSF number is only a basic identification number.































Stick components are available in 12'1" (open sections), 10'6" (closed sections) lengths and pre-sized lengths for 6'8", 7'0", 7'2" and 8'0" door heights. Sections can be blank (no cutouts), have strike or hinge preps to match doors and other three sided frames. See the exact TSF number for the hardware prep that is included.













Single Rabbet	Double Rabbet	TSF #	Description
		TSF-6	6'8" Double Hinge Mullion
		TSF-7	6'8" Double Strike Mullion
		TSF-8 R/L	6'8" Hinge and Strike Mullion
		TSF-9 R/L	6'8" Single Hinge Mullion
		TSF-10 R/L	6'8" Single Strike Mullion
		TSF-11	7'0" Double Hinge Mullion
		TSF-12	7'0" Double Strike Mullion
		TSF-13 R/L	7'0" Hinge and Strike Mullion
		TSF-14 R/L	7'0" Single Hinge Mullion
		TSF-15 R/L	7'0" Single Strike Mullion
		TSF-16	Blank Mullion 2" Face 10'6"
		TSF-20	7'0" Blank Mullion
		TSF-21	Blank Rail 2" Face 12'1"
		TSF-22	Filler with 5/8" Stop 12'1"
		TSF-23	Blank Rail 4" Face 12'1"
		TSF-24 R/L	6'8" End Hinge Jamb 12'1"
		TSF-25 R/L	7'0" End Hinge Jamb 12'1"
		TSF-26 R/L	End Strike Jamb 12'1" (All Heights)
		TSF-27	Filler without Stop 12'1"
		TSF-32	7'2" Double Hinge Mullion

Single Rabbet	Double Rabbet	TSF #	Description
		TSF-33	7'2" Double Strike Mullion
		TSF-34 R/L	7'2" Hinge and Strike Mullion
		TSF-35 R/L	7'2" Single Hinge Mullion
		TSF-36 R/L	7'2" Single Strike Mullion
		TSF-39 R/L	7'2" End Hinge Jamb 12'1"
		TSF-40	Cased Open Section 12'1"
		TSF-41 R/L	Single Strike Mullion 10'6" (All heights)
		TSF-42 R/L	6'8" Single Hinge Mullion 10'6"
		TSF-43 R/L	7'0" Single Hinge Mullion 10'6"
		TSF-44 R/L	7'2" Single Hinge Mullion 10'6"
		TSF-45 R/L	6'8" Hinge and Strike Mullion 10'6"
		TSF-46 R/L	7'0" Hinge and Strike Mullion 10'6"
		TSF-47 R/L	7'2" Hinge and Strike Mullion 10'6"
Not Available		TSF-51	2 Way Corner Post 1-9/16" Rabbet Outside 10'6"
Not Available		TSF-52	2 Way Corner Post 1-15/16" Rabbet Outside 10'6"
Not Available		TSF-53	3 Way Corner Post 1-9/16" Rabbet Outside 10'6"
Not Available		TSF-54	3 Way Corner Post 1-15/16" Rabbet Outside 10'6"

Prices subject to change without notice.

TSF PARTS LIST

Single Rabbet	Double Rabbet	TSF #	Description
See TSF 93		TSF-56	6'8" Removable Mullion Double Strike
See TSF 94		TSF-57	7'0" Removable Mullion Double Strike
See TSF 96		TSF-58	7'2" Removable Mullion Double Strike
See TSF 98		TSF-59	8'0" Removable Mullion Double Strike
		TSF-80	8'0" Double Hinge Mullion
		TSF-81	8'0" Double Strike Mullion
		TSF-82 R/L	8'0" Hinge and Strike Mullion
		TSF-83 R/L	8'0" Single Hinge Mullion
		TSF-84 R/L	8'0" Single Strike Mullion
		TSF-85 R/L	8'0" End Hinge Jamb 10'6"
		TSF-86	8'0" Blank Mullion
		TSF-87 R/L	8'0" Single Hinge Mullion 10'6"
		TSF-88 R/L	8'0" Hinge and Strike Mullion 10'6"
Not Available		TSF-89	Snap-in Filler with 5/8" Stop 12'1"
	See TSF-56	TSF-93	6'8" Removable Mullion Double Strike
	See TSF-57	TSF-94	7'0" Removable Mullion Double Strike
Not Available		TSF-95	5/8" Stop 12'1"
	See TSF-58	TSF-96	7'2" Removable Mullion Double Strike
	See TSF-59	TSF-98	8'0" Removable Mullion Double Strike
		TSF-99	Blank Mullion 4" Face 10'6"

Single Rabbet	Double Rabbet	TSF #	Description
Not Available		TSF-102	Un-assembled Transom Bar Side A 1-9/16" 10'6"
Not Available		TSF-103	Un-assembled Transom Bar Side B 1-15/16" 10'6"
		TSF-104	Flush Sill Section Galvannealed 8-1/8" High 12'1"
		TSF-105	Flush Sill Section Galvannealed 6-1/8" High 12'1"
		TSF-106	Flush Sill Section Galvannealed 16-1/8" High 12'1"
Not Available		TSF-132 R/L	Blank Partial Sidelite Mullion 40" Notch 10'6"
Not Available		TSF-133 R/L	Single Strike Partial Sidelite Mullion with 40" Notch 10'6"
Not Available		TSF-134 R/L	Blank Partial Sidelite Mullion 40" Notch 7'0"
Not Available		TSF-135 RL	Single Strike Partial Sidelite Mullion 40" Notch 7'0"

Prices subject to change without notice.

STICK LENGTHS (TSF PARTS)

F16 and FN16-SERIES

STICKS

OPEN SECTIONS (12'1" LENGTHS)

TSF #	Description	3"-5 ⁷ / ₈ "		6"-7 ⁷ / ₈ "		8"-9 ⁷ / ₈ "		10"-11 ⁷ / ₈ "		12"-14 ³ / ₄ "	
		CRS	GALV	CRS	GALV	CRS	GALV	CRS	GALV	CRS	GALV
21	Blank rail	\$197	\$233	\$213	\$237	\$272	\$296	\$324	\$363	\$394	\$432
23	Blank rail - 4" face	\$263	\$294	\$285	\$309	\$361	\$389	\$424	\$455	\$516	\$541
40	Cased open blank rail	\$197	\$233	\$213	\$237	\$272	\$296	\$324	\$363	\$394	\$432
24	Hinge jamb 6'8" locations	\$260	\$296	\$276	\$300	\$335	\$359	\$387	\$426	\$457	\$495
25	7'0" locations	\$260	\$296	\$276	\$300	\$335	\$359	\$387	\$426	\$457	\$495
39	7'2" locations	\$260	\$296	\$276	\$300	\$335	\$359	\$387	\$426	\$457	\$495
85	8'0" locations	\$281	\$317	\$297	\$321	\$356	\$380	\$408	\$447	\$478	\$516
26	Strike jamb - all	\$218	\$254	\$234	\$258	\$293	\$317	\$345	\$384	\$415	\$453

SILL SECTIONS AND FILLER PLATES (12'1" LENGTHS)

TSF #	Description	3 ³ / ₄ "-5 ⁷ / ₈ "		6"-7 ⁷ / ₈ "		8"-9 ⁷ / ₈ "		10"-11 ⁷ / ₈ "		12"-14 ³ / ₄ "	
		CRS	GALV	CRS	GALV	CRS	GALV	CRS	GALV	CRS	GALV
105	Sill 6 ¹ / ₈ " full jamb depth	-	\$520	-	\$628	-	\$675	-	\$723	-	\$799
104	Sill 8 ¹ / ₈ " full jamb depth	-	\$520	-	\$628	-	\$675	-	\$723	-	\$799
106	Sill 16 ¹ / ₈ " full jamb depth	-	\$591	-	\$681	-	\$721	-	\$815	-	\$905
107	Sill 8 ¹ / ₈ " rec. 1 ⁹ / ₁₆ " deep	-	\$520	-	\$628	-	\$675	-	\$723	-	\$799
108	Sill 8 ¹ / ₈ " rec. 1 ⁵ / ₁₆ " deep	-	\$520	-	\$628	-	\$675	-	\$723	-	\$799
22	Filler plate with stop	\$219	\$245	\$242	\$267	\$256	\$282	\$284	\$308	\$345	\$371
27	Filler plate without stop	\$219	\$245	\$242	\$267	\$256	\$282	\$284	\$308	\$345	\$371
89	Snap-in filler plate with stop	\$291	\$315	\$301	\$326	\$308	\$334	\$341	\$363	\$356	\$380

CORNER POSTS (10'6" LENGTHS)

TSF #	Description	4 ³ / ₄ "-5 ⁷ / ₈ "		6"-7 ⁷ / ₈ "		8"-9 ⁷ / ₈ "		10"-11 ⁷ / ₈ "		12"-14 ³ / ₄ "	
		CRS	GALV	CRS	GALV	CRS	GALV	CRS	GALV	CRS	GALV
51	2-Way post 1 ⁹ / ₁₆ " outside	\$720	\$755	\$760	\$790	\$793	\$830	\$925	\$961	\$1,094	\$1,119
52	2-Way post 1 ⁵ / ₁₆ " outside	\$720	\$755	\$760	\$790	\$793	\$830	\$925	\$961	\$1,094	\$1,119
53	3-Way post 1 ⁹ / ₁₆ " outside	\$720	\$755	\$760	\$790	\$793	\$830	\$925	\$961	\$1,094	\$1,119
54	3-Way post 1 ⁵ / ₁₆ " outside	\$720	\$755	\$760	\$790	\$793	\$830	\$925	\$961	\$1,094	\$1,119

CLOSED SECTION MULLIONS (10'6" LENGTHS)

TSF #	Description	3"-5 ⁷ / ₈ "		6"-7 ⁷ / ₈ "		8"-9 ⁷ / ₈ "		10"-11 ⁷ / ₈ "		12"-14 ³ / ₄ "	
		CRS	GALV	CRS	GALV	CRS	GALV	CRS	GALV	CRS	GALV
16	Blank mullion	\$378	\$420	\$432	\$477	\$480	\$515	\$560	\$625	\$671	\$736
99	Blank mullion - 4" face	\$491	\$528	\$568	\$591	\$631	\$638	\$733	\$778	\$837	\$910
41	Single strike - all	\$399	\$441	\$453	\$498	\$501	\$536	\$581	\$646	\$692	\$757
42	Single hinge 6'8" locations	\$441	\$483	\$495	\$540	\$543	\$578	\$623	\$688	\$734	\$799
43	7'0" locations	\$441	\$483	\$495	\$540	\$543	\$578	\$623	\$688	\$734	\$799
44	7'2" locations	\$441	\$483	\$495	\$540	\$543	\$578	\$623	\$688	\$734	\$799
87	8'0" locations	\$462	\$504	\$516	\$561	\$564	\$599	\$644	\$709	\$755	\$820
45	Hinge and strike 6'8" locations	\$462	\$504	\$516	\$561	\$564	\$599	\$644	\$709	\$755	\$820
46	7'0" locations	\$462	\$504	\$516	\$561	\$564	\$599	\$644	\$709	\$755	\$820
47	7'2" locations	\$462	\$504	\$516	\$561	\$564	\$599	\$644	\$709	\$755	\$820
88	8'0" locations	\$483	\$525	\$537	\$582	\$585	\$620	\$665	\$730	\$776	\$841

Prices subject to change without notice.

CLOSED SECTION MULLIONS (Pre-cut to a specific opening height)

TSF #	Description	3"-5 ⁷ / ₈ "		6"-7 ⁷ / ₈ "		8"-9 ⁷ / ₈ "		10"-11 ⁷ / ₈ "		12"-14 ³ / ₄ "		
		CRS	GALV	CRS	GALV	CRS	GALV	CRS	GALV	CRS	GALV	
FIXED MULLIONS												
20	Blank	7'0" door height	\$271	\$299	\$307	\$337	\$339	\$363	\$393	\$436	\$467	\$510
86		8'0" door height	\$307	\$339	\$348	\$382	\$385	\$412	\$446	\$495	\$531	\$580
10	Single strike	6'8" door height	\$280	\$307	\$314	\$343	\$345	\$367	\$396	\$437	\$466	\$507
15		7'0" door height	\$292	\$320	\$328	\$358	\$360	\$384	\$414	\$457	\$488	\$531
36		7'2" door height	\$298	\$327	\$335	\$365	\$368	\$392	\$422	\$466	\$498	\$542
84		8'0" door height	\$328	\$360	\$369	\$403	\$406	\$433	\$467	\$516	\$552	\$601
7	Double strike	6'8" door height	\$301	\$328	\$335	\$364	\$366	\$388	\$417	\$458	\$487	\$528
12		7'0" door height	\$313	\$341	\$349	\$379	\$381	\$405	\$435	\$478	\$509	\$552
33		7'2" door height	\$319	\$348	\$356	\$386	\$389	\$413	\$443	\$487	\$519	\$563
81		8'0" door height	\$349	\$381	\$390	\$424	\$427	\$454	\$488	\$537	\$573	\$622
8	Strike and hinge	6'8" door height	\$343	\$370	\$377	\$406	\$408	\$430	\$459	\$500	\$529	\$570
13		7'0" door height	\$355	\$383	\$391	\$421	\$423	\$447	\$477	\$520	\$551	\$594
34		7'2" door height	\$361	\$390	\$398	\$428	\$431	\$455	\$485	\$529	\$561	\$605
82		8'0" door height	\$412	\$444	\$453	\$487	\$490	\$517	\$551	\$600	\$636	\$685
9	Single hinge	6'8" door height	\$322	\$349	\$356	\$385	\$387	\$409	\$438	\$479	\$508	\$549
14		7'0" door height	\$334	\$354	\$362	\$392	\$394	\$418	\$448	\$491	\$522	\$565
35		7'2" door height	\$340	\$369	\$377	\$407	\$410	\$434	\$464	\$508	\$540	\$584
83		8'0" door height	\$391	\$423	\$432	\$466	\$469	\$496	\$530	\$579	\$615	\$664
6	Double hinge	6'8" door height	\$385	\$412	\$419	\$448	\$450	\$472	\$501	\$542	\$571	\$612
11		7'0" door height	\$397	\$425	\$433	\$463	\$465	\$489	\$519	\$562	\$593	\$636
32		7'2" door height	\$403	\$432	\$440	\$470	\$473	\$497	\$527	\$571	\$603	\$647
80		8'0" door height	\$475	\$507	\$516	\$550	\$553	\$580	\$614	\$663	\$699	\$748

TSF #	Description	3"-5 ⁷ / ₈ "		6"-7 ⁷ / ₈ "		8"-9 ⁷ / ₈ "		10"-11 ⁷ / ₈ "		12"-14 ³ / ₄ "		
		CRS	GALV	CRS	GALV	CRS	GALV	CRS	GALV	CRS	GALV	
REMOVABLE MULLIONS (Minimum jamb depth 4-3/4" / double rabbet only)												
56	Double strike	6'8" door height	\$383	\$404	\$411	\$440	\$442	\$464	\$493	\$534	\$563	\$604
57		7'0" door height	\$395	\$417	\$425	\$455	\$457	\$481	\$511	\$554	\$585	\$628
58		7'2" door height	\$401	\$424	\$432	\$462	\$465	\$489	\$519	\$563	\$595	\$639
59		8'0" door height	\$431	\$457	\$466	\$500	\$503	\$530	\$564	\$613	\$649	\$698

MISCELLANEOUS CLOSED SECTION MULLIONS

TSF #	Description	4 ¹ / ₂ "-5 ⁷ / ₈ "		6"-7 ⁷ / ₈ "		8"-9 ⁷ / ₈ "		10"-11 ⁷ / ₈ "		12"-14 ³ / ₄ "	
		CRS	GALV	CRS	GALV	CRS	GALV	CRS	GALV	CRS	GALV
102	Slide together mullion - part A	\$178	\$198	\$232	\$254	\$266	\$276	\$315	\$356	\$382	\$422
103	Slide together mullion - part B	\$167	\$192	\$167	\$192	\$167	\$192	\$167	\$192	\$167	\$192
132	Partial notch side light mullion 10'6" blank	\$410	\$452	\$464	\$509	\$512	\$547	\$592	\$657	\$703	\$768
133	Partial notch side light mullion 10'6" single ASA strike	\$431	\$473	\$485	\$530	\$533	\$568	\$613	\$678	\$724	\$789
134	Partial notch side light mullion 7'0" blank	\$303	\$331	\$339	\$369	\$371	\$395	\$425	\$468	\$499	\$542
135	Partial notch side light mullion 7'0" single ASA strike	\$324	\$352	\$360	\$390	\$392	\$416	\$446	\$489	\$520	\$563

NOTES:

- Slide together mullion parts are field assembled. When assembled, part "B" forms the door rabbet. Refer to the TSF Parts List in this section.
- Partial notch side light mullions have a 40" long notch from bottom of frame and a minimum jamb depth of 4 1/2"

Prices subject to change without notice.

STICK LENGTHS (TSF PARTS)

F14 and FN14-SERIES

STICKS

OPEN SECTIONS (12'1" LENGTHS)

TSF #	Description	3"-5 ⁷ / ₈ "		6"-7 ⁷ / ₈ "		8"-9 ⁷ / ₈ "		10"-11 ⁷ / ₈ "		12"-14 ³ / ₄ "	
		CRS	GALV	CRS	GALV	CRS	GALV	CRS	GALV	CRS	GALV
21	Blank rail	\$232	\$272	\$267	\$293	\$337	\$365	\$380	\$406	\$469	\$505
23	Blank rail - 4" face	\$306	\$343	\$332	\$363	\$428	\$452	\$479	\$504	\$603	\$629
40	Cased open blank rail	\$232	\$272	\$267	\$293	\$337	\$365	\$380	\$406	\$469	\$505
24	Hinge jamb 6'8" locations	\$295	\$335	\$330	\$356	\$400	\$428	\$443	\$469	\$532	\$568
25	7'0" locations	\$295	\$335	\$330	\$356	\$400	\$428	\$443	\$469	\$532	\$568
39	7'2" locations	\$295	\$335	\$330	\$356	\$400	\$428	\$443	\$469	\$532	\$568
85	8'0" locations	\$316	\$356	\$351	\$377	\$421	\$449	\$464	\$490	\$553	\$589
26	Strike jamb - all	\$253	\$293	\$288	\$314	\$358	\$386	\$401	\$427	\$490	\$526

SILL SECTIONS AND FILLER PLATES (12'1" LENGTHS)

TSF #	Description	3 ³ / ₄ "-5 ⁷ / ₈ "		6"-7 ⁷ / ₈ "		8"-9 ⁷ / ₈ "		10"-11 ⁷ / ₈ "		12"-14 ³ / ₄ "	
		CRS	GALV	CRS	GALV	CRS	GALV	CRS	GALV	CRS	GALV
105	Sill 6 ¹ / ₈ " full jamb depth	-	\$616	-	\$742	-	\$833	-	\$890	-	\$985
104	Sill 8 ¹ / ₈ " full jamb depth	-	\$616	-	\$742	-	\$833	-	\$890	-	\$985
106	Sill 16 ¹ / ₈ " full jamb depth	-	\$700	-	\$789	-	\$874	-	\$953	-	\$1,194
107	Sill 8 ¹ / ₈ " rec. 1 ⁹ / ₁₆ " deep	-	\$616	-	\$742	-	\$833	-	\$890	-	\$985
108	Sill 8 ¹ / ₈ " rec. 1 ⁵ / ₁₆ " deep	-	\$616	-	\$742	-	\$833	-	\$890	-	\$985
22	Filler plate with stop	\$254	\$287	\$271	\$302	\$287	\$321	\$337	\$371	\$424	\$456
27	Filler plate without stop	\$254	\$287	\$271	\$302	\$287	\$321	\$337	\$371	\$424	\$456
89	Snap-in filler plate with stop	\$300	\$332	\$321	\$352	\$339	\$374	\$358	\$389	\$448	\$482

CORNER POSTS (10'6" LENGTHS)

TSF #	Description	4 ³ / ₄ "-5 ⁷ / ₈ "		6"-7 ⁷ / ₈ "		8"-9 ⁷ / ₈ "		10"-11 ⁷ / ₈ "		12"-14 ³ / ₄ "	
		CRS	GALV	CRS	GALV	CRS	GALV	CRS	GALV	CRS	GALV
51	2-Way post 1 ⁹ / ₁₆ " outside	\$783	\$813	\$841	\$868	\$937	\$982	\$1,047	\$1,087	\$1,230	\$1,261
52	2-Way post 1 ⁵ / ₁₆ " outside	\$783	\$813	\$841	\$868	\$937	\$982	\$1,047	\$1,087	\$1,230	\$1,261
53	3-Way post 1 ⁹ / ₁₆ " outside	\$783	\$813	\$841	\$868	\$937	\$982	\$1,047	\$1,087	\$1,230	\$1,261
54	3-Way post 1 ⁵ / ₁₆ " outside	\$783	\$813	\$841	\$868	\$937	\$982	\$1,047	\$1,087	\$1,230	\$1,261

CLOSED SECTION MULLIONS (10'6" LENGTHS)

TSF #	Description	3"-5 ⁷ / ₈ "		6"-7 ⁷ / ₈ "		8"-9 ⁷ / ₈ "		10"-11 ⁷ / ₈ "		12"-14 ³ / ₄ "	
		CRS	GALV	CRS	GALV	CRS	GALV	CRS	GALV	CRS	GALV
16	Blank mullion	\$438	\$473	\$533	\$562	\$581	\$610	\$660	\$697	\$784	\$820
99	Blank mullion - 4" face	\$562	\$596	\$676	\$705	\$734	\$762	\$847	\$878	\$974	\$105
41	Single strike - all	\$459	\$494	\$554	\$583	\$602	\$631	\$681	\$718	\$805	\$841
42	Single hinge 6'8" locations	\$501	\$536	\$596	\$625	\$644	\$673	\$723	\$760	\$847	\$883
43	7'0" locations	\$501	\$536	\$596	\$625	\$644	\$673	\$723	\$760	\$847	\$883
44	7'2" locations	\$501	\$536	\$596	\$625	\$644	\$673	\$723	\$760	\$847	\$883
87	8'0" locations	\$522	\$557	\$617	\$646	\$665	\$694	\$744	\$781	\$868	\$904
45	Hinge and strike 6'8" locations	\$522	\$557	\$617	\$646	\$665	\$694	\$744	\$781	\$868	\$904
46	7'0" locations	\$522	\$557	\$617	\$646	\$665	\$694	\$744	\$781	\$868	\$904
47	7'2" locations	\$522	\$557	\$617	\$646	\$665	\$694	\$744	\$781	\$868	\$904
88	8'0" locations	\$543	\$578	\$638	\$667	\$686	\$715	\$765	\$802	\$889	\$925

Prices subject to change without notice.

CLOSED SECTION MULLIONS (Pre-cut to a specific opening height)

TSF #	Description	3"-5 ⁷ / ₈ "		6"-7 ⁷ / ₈ "		8"-9 ⁷ / ₈ "		10"-11 ⁷ / ₈ "		12"-14 ³ / ₄ "		
		CRS	GALV	CRS	GALV	CRS	GALV	CRS	GALV	CRS	GALV	
FIXED MULLIONS												
20	Blank	7'0" door height	\$311	\$335	\$374	\$394	\$407	\$426	\$459	\$484	\$542	\$565
86		8'0" door height	\$353	\$380	\$425	\$447	\$462	\$484	\$522	\$550	\$616	\$643
10	Single strike	6'8" door height	\$318	\$341	\$378	\$397	\$409	\$427	\$459	\$483	\$538	\$560
15		7'0" door height	\$332	\$356	\$395	\$415	\$428	\$447	\$480	\$505	\$563	\$586
36		7'2" door height	\$339	\$363	\$404	\$424	\$437	\$457	\$491	\$516	\$575	\$599
84		8'0" door height	\$374	\$401	\$446	\$468	\$483	\$505	\$543	\$571	\$637	\$664
7	Double strike	6'8" door height	\$339	\$362	\$399	\$418	\$430	\$448	\$480	\$504	\$559	\$581
12		7'0" door height	\$353	\$377	\$416	\$436	\$449	\$468	\$501	\$526	\$584	\$607
33		7'2" door height	\$360	\$384	\$425	\$445	\$458	\$478	\$512	\$537	\$596	\$620
81		8'0" door height	\$395	\$422	\$467	\$489	\$504	\$526	\$564	\$592	\$658	\$685
8	Strike and hinge	6'8" door height	\$381	\$404	\$441	\$460	\$472	\$490	\$522	\$546	\$601	\$623
13		7'0" door height	\$395	\$419	\$458	\$478	\$491	\$510	\$543	\$568	\$626	\$649
34		7'2" door height	\$402	\$426	\$467	\$487	\$500	\$520	\$554	\$579	\$638	\$662
82		8'0" door height	\$458	\$485	\$530	\$552	\$567	\$589	\$627	\$655	\$721	\$748
9	Single hinge	6'8" door height	\$360	\$383	\$420	\$439	\$451	\$469	\$501	\$525	\$580	\$602
14		7'0" door height	\$374	\$398	\$437	\$457	\$470	\$489	\$522	\$547	\$605	\$628
35		7'2" door height	\$381	\$405	\$446	\$466	\$479	\$499	\$533	\$558	\$617	\$641
83		8'0" door height	\$437	\$464	\$509	\$531	\$546	\$568	\$606	\$634	\$700	\$727
6	Double hinge	6'8" door height	\$423	\$446	\$483	\$502	\$514	\$532	\$564	\$588	\$643	\$665
11		7'0" door height	\$437	\$461	\$500	\$520	\$533	\$552	\$585	\$610	\$668	\$691
32		7'2" door height	\$444	\$468	\$509	\$529	\$542	\$562	\$596	\$621	\$680	\$704
80		8'0" door height	\$521	\$548	\$593	\$615	\$630	\$652	\$690	\$718	\$784	\$811
REMOVABLE MULLIONS (Minimum jamb depth 4 3/4" / double rabbet only)												
56	Double strike	6'8" door height	\$421	\$444	\$481	\$500	\$512	\$530	\$562	\$586	\$641	\$663
57		7'0" door height	\$435	\$459	\$498	\$518	\$531	\$550	\$583	\$608	\$666	\$689
58		7'2" door height	\$442	\$466	\$507	\$527	\$540	\$560	\$594	\$619	\$678	\$702
59		8'0" door height	\$477	\$504	\$549	\$571	\$586	\$608	\$646	\$674	\$740	\$767

NOTE:

1. Single rabbet removable mullion is 3" jamb depth only. See TSF Parts List in the section.

MISCELLANEOUS CLOSED SECTION MULLIONS

TSF #	Description	4 ¹ / ₂ "-5 ⁷ / ₈ "		6"-7 ⁷ / ₈ "		8"-9 ⁷ / ₈ "		10"-11 ⁷ / ₈ "		12"-14 ³ / ₄ "	
		CRS	GALV	CRS	GALV	CRS	GALV	CRS	GALV	CRS	GALV
102	Slide together mullion - part A	\$222	\$229	\$302	\$318	\$334	\$350	\$382	\$408	\$462	\$486
103	Slide together mullion - part B	\$202	\$214	\$202	\$214	\$202	\$214	\$202	\$214	\$202	\$214
132	Partial notch side light mullion 10'6" blank	\$470	\$505	\$565	\$594	\$613	\$642	\$692	\$729	\$816	\$852
133	Partial notch side light mullion 10'6" single ASA strike	\$491	\$526	\$586	\$615	\$634	\$663	\$713	\$750	\$837	\$873
134	Partial notch side light mullion 7'0" blank	\$343	\$367	\$406	\$426	\$439	\$458	\$491	\$516	\$574	\$597
135	Partial notch side light mullion 7'0" single ASA strike	\$364	\$388	\$427	\$447	\$460	\$479	\$512	\$537	\$595	\$618

NOTES:

- Slide together mullion parts are field assembled. When assembled, part "B" forms the door rabbet. Refer to the TSF Parts List in this section.
- Partial notch side light mullions have a 40" long notch from bottom of frame and a minimum jamb depth of 4 1/2"

Prices subject to change without notice.

STICK LENGTHS

(TSF PARTS) CONSTRUCTION AND HARDWARE

CONSTRUCTION OPTIONS: Add per stick

SPECIAL PROFILE OPEN, SILL AND FILLER PLATE SECTIONS:

- Special face dimension:
 - 1" thru 4" face\$46
 - Over 4" thru 8".....\$65
 - Over 8" thru 18".....\$79
- Special backbends:
 - 3/8" min thru 1 7/8" max..... \$37
 - MU-Series\$24
- 3/4" thru 1 1/4" high stops..... \$37

SPECIAL PROFILE MULLIONS:

NOTE: Special profile mullions will not be internally reinf.

- Special face dimensions
 - 1" thru 4" face (2" & TSF 99 - 4" are standard)\$46
 - Over 4" thru 8"\$65
 - Over 8" thru 18".....\$79
- Single rabbet \$37
 - 3/4" thru 1 1/4" high stops..... \$37

REMOVABLE MULLION PREP\$82

MARK NUMBERS N/C

HARDWARE OPTIONS: Add per stick

SPECIAL VERTICAL HARDWARE LOCATIONS:

- Hinge and strike N/C

HINGES:

- Additional hinge prep (4 1/2" or 5")\$21
- 5" universal in lieu of 4 1/2"..... N/C
- High frequency prep (per hinge prep)..... \$25

STRIKES:

- Additional 4 7/8" ASA strike.....\$21
- 2 3/4" CYL strike in lieu of 4 7/8" ASA..... N/C
- Additional CYL strike\$21
- Deadlock strike (non-lip).....\$21
- Rim exit device reinf.\$29

NOTES:

1. Construction and hardware options shown on this page are applicable to Stick Lengths (TSF Parts) pricing shown in this section
2. Special profile open, sill and filler plate pricing does not apply to standard sizes

Prices subject to change without notice.

4-SIDED, K/D BORROWED LIGHT FRAMES

Description		3" - 5 ⁷ / ₈ "		6" - 7 ⁷ / ₈ "		8" - 9 ⁷ / ₈ "	
Glass Opening Width	Glass Opening Height	CRS	GALV	CRS	GALV	CRS	GALV
SINGLE FRAMES							
2'0" thru 3'0"	2'0" thru 2'6"	\$320	\$353	\$335	\$356	\$388	\$409
	2'8" thru 3'4"	\$350	\$387	\$366	\$391	\$426	\$451
	3'6" thru 4'0"	\$379	\$420	\$398	\$425	\$465	\$493
	4'8" thru 5'4"	\$429	\$477	\$450	\$483	\$530	\$562
	5'8" thru 6'10"	\$478	\$534	\$503	\$540	\$594	\$632
3'2" thru 4'0"	2'0" thru 2'6"	\$363	\$402	\$380	\$406	\$444	\$469
	2'8" thru 3'4"	\$393	\$436	\$412	\$441	\$482	\$511
	3'6" thru 4'0"	\$422	\$469	\$443	\$475	\$521	\$553
	4'8" thru 5'4"	\$471	\$526	\$496	\$533	\$586	\$622
	5'8" thru 6'10"	\$520	\$583	\$548	\$590	\$651	\$692
4'0" thru 6'0"	2'0" thru 2'6"	\$419	\$466	\$440	\$471	\$517	\$548
	2'8" thru 3'4"	\$448	\$500	\$471	\$506	\$556	\$590
	3'6" thru 4'0"	\$478	\$534	\$503	\$540	\$594	\$632
	4'8" thru 5'4"	\$527	\$590	\$555	\$598	\$659	\$701
	5'8" thru 6'10"	\$576	\$647	\$608	\$655	\$724	\$771
6'2" thru 8'0"	2'0" thru 2'6"	\$497	\$556	\$524	\$563	\$620	\$660
	2'8" thru 3'4"	\$527	\$590	\$555	\$598	\$659	\$701
	3'6" thru 4'0"	\$556	\$624	\$587	\$632	\$698	\$743
	4'8" thru 5'4"	\$606	\$681	\$639	\$690	\$763	\$813
	5'8" thru 6'10"	\$655	\$737	\$692	\$747	\$827	\$882

NOTES:

1. For borrowed lights larger than sizes shown, price as lineal inch
2. Refer to Lineal Inch Sticks OPTIONS in this section for options available for 4 sided frames
3. Prices include standard loose jamb and base anchors
4. Prices for rabbeted and cased open
5. Cased open borrowed light does not include glazing bead
6. Minimum size 1'0" x 1'0"
7. G-90 galvanize - multiply "GALV" price by 1.25 (maximum height 120")

CONSTRUCTION OPTIONS:

Per frame

Deduct anchors: thru 4'0"deduct \$13
 over 4'0" high..... deduct \$19.50

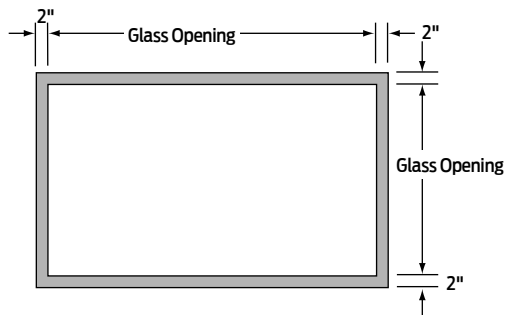

Prices subject to change without notice.

4-SIDED, K/D BORROWED LIGHT FRAME

Description		3"- 5 ⁷ / ₈ "		6"- 7 ⁷ / ₈ "		8"- 9 ⁷ / ₈ "	
Glass Opening Width	Glass Opening Height	CRS	GALV	CRS	GALV	CRS	GALV
SINGLE FRAMES							
2'0" thru 3'0"	2'0" thru 2'6"	\$352	\$387	\$383	\$406	\$446	\$471
	2'8" thru 3'4"	\$385	\$426	\$421	\$448	\$492	\$521
	3'6" thru 4'0"	\$419	\$465	\$459	\$489	\$539	\$572
	4'8" thru 5'4"	\$476	\$530	\$523	\$558	\$617	\$656
	5'8" thru 6'10"	\$532	\$594	\$586	\$627	\$695	\$740
3'2" thru 4'0"	2'0" thru 2'6"	\$400	\$443	\$438	\$466	\$513	\$544
	2'8" thru 3'4"	\$434	\$482	\$476	\$508	\$560	\$594
	3'6" thru 4'0"	\$468	\$521	\$514	\$549	\$607	\$645
	4'8" thru 5'4"	\$524	\$586	\$578	\$618	\$685	\$728
	5'8" thru 6'10"	\$581	\$650	\$641	\$687	\$763	\$812
4'0" thru 6'0"	2'0" thru 2'6"	\$464	\$517	\$510	\$544	\$602	\$639
	2'8" thru 3'4"	\$498	\$555	\$548	\$586	\$648	\$689
	3'6" thru 4'0"	\$532	\$594	\$586	\$627	\$695	\$740
	4'8" thru 5'4"	\$588	\$659	\$650	\$696	\$773	\$823
	5'8" thru 6'10"	\$644	\$723	\$713	\$765	\$851	\$907
6'2" thru 8'0"	2'0" thru 2'6"	\$554	\$620	\$612	\$655	\$727	\$773
	2'8" thru 3'4"	\$588	\$659	\$650	\$696	\$773	\$823
	3'6" thru 4'0"	\$622	\$698	\$688	\$738	\$820	\$874
	4'8" thru 5'4"	\$678	\$762	\$752	\$807	\$898	\$958
	5'8" thru 6'10"	\$735	\$827	\$815	\$876	\$976	\$1,042

NOTES:

1. For borrowed lights larger than sizes shown, price as lineal inch
2. Refer to Lineal Inch Sticks OPTIONS in this section for options available for 4 sided frames
3. Prices include standard loose jamb and base anchors
4. Prices for rabbeted and cased open
5. Cased open borrowed light does not include glazing bead
6. Minimum size 1'0" x 1'0"
7. G-90 galvanize - multiply "GALV" price by 1.25 (maximum height 120")

CONSTRUCTION OPTIONS:

Per frame

Deduct anchors: thru 4'0".....deduct \$13
 over 4'0" high..... deduct \$19.50

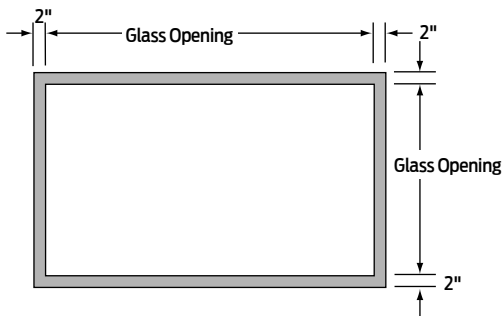

Prices subject to change without notice.

BORROWED LIGHT FRAMES

K/D, CRS OR GALVANNEALED

MU/DW16-SERIES

STICKS

4-SIDED, K/D BORROWED LIGHT FRAME

Description		4 1/2" - 5 7/8"		6" - 7 7/8"		8" - 9"	
Glass Opening Width	Glass Opening Height	CRS	GALV	CRS	GALV	CRS	GALV
SINGLE FRAMES							
2'0" thru 3'0"	2'0" thru 2'6"	\$343	\$375	\$357	\$379	\$410	\$431
	2'8" thru 3'4"	\$375	\$412	\$392	\$416	\$452	\$476
	3'6" thru 4'0"	\$408	\$449	\$426	\$454	\$493	\$521
	4'8" thru 5'4"	\$462	\$510	\$484	\$516	\$563	\$595
	5'8" thru 6'10"	\$516	\$572	\$541	\$579	\$633	\$670
3'2" thru 4'0"	2'0" thru 2'6"	\$390	\$428	\$407	\$433	\$470	\$496
	2'8" thru 3'4"	\$422	\$465	\$442	\$470	\$512	\$541
	3'6" thru 4'0"	\$455	\$502	\$476	\$508	\$554	\$586
	4'8" thru 5'4"	\$509	\$564	\$534	\$570	\$624	\$660
	5'8" thru 6'10"	\$563	\$625	\$591	\$633	\$693	\$735
4'0" thru 6'0"	2'0" thru 2'6"	\$451	\$498	\$472	\$504	\$549	\$581
	2'8" thru 3'4"	\$484	\$535	\$507	\$541	\$591	\$625
	3'6" thru 4'0"	\$516	\$572	\$541	\$579	\$633	\$670
	4'8" thru 5'4"	\$570	\$634	\$599	\$641	\$703	\$745
	5'8" thru 6'10"	\$625	\$695	\$657	\$704	\$772	\$820
6'2" thru 8'0"	2'0" thru 2'6"	\$538	\$597	\$564	\$604	\$661	\$700
	2'8" thru 3'4"	\$570	\$634	\$599	\$641	\$703	\$745
	3'6" thru 4'0"	\$603	\$671	\$634	\$679	\$744	\$790
	4'8" thru 5'4"	\$657	\$732	\$691	\$741	\$814	\$864
	5'8" thru 6'10"	\$711	\$794	\$749	\$804	\$884	\$939

NOTES:

- Prices above include loose glazing beads, cut to length, with self-drilling attaching screws
- Maximum sizes as listed
- Minimum size 1'6" x 1'6"
- DW frames have compression anchors in head and sill only. MU-Series frames are the same prices as shown.
- Jambes are mitered with corner tabs
- Prices for rabbeted and cased open
- Cased open borrowed light does not include glazing bead
- For borrowed lights other than sizes shown, price as lineal inch
- G-90 galvanize - multiply "GALV" price by 1.25 (maximum height 120")

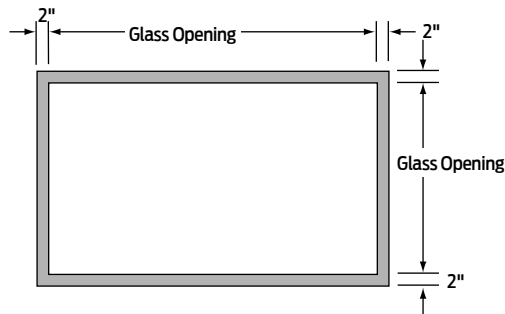

Prices subject to change without notice.

4-SIDED, K/D BORROWED LIGHT FRAME

Description		4 1/2" - 5 7/8"		6" - 7 7/8"		8" - 9"	
Glass Opening Width	Glass Opening Height	CRS	GALV	CRS	GALV	CRS	GALV
SINGLE FRAMES							
2'0" thru 3'0"	2'0" thru 2'6"	\$375	\$411	\$406	\$430	\$469	\$494
	2'8" thru 3'4"	\$412	\$453	\$448	\$474	\$519	\$548
	3'6" thru 4'0"	\$449	\$495	\$489	\$519	\$569	\$602
	4'8" thru 5'4"	\$511	\$565	\$558	\$593	\$652	\$691
	5'8" thru 6'10"	\$572	\$635	\$627	\$668	\$736	\$780
3'2" thru 4'0"	2'0" thru 2'6"	\$428	\$471	\$466	\$494	\$541	\$572
	2'8" thru 3'4"	\$465	\$513	\$507	\$539	\$591	\$625
	3'6" thru 4'0"	\$502	\$555	\$549	\$583	\$641	\$679
	4'8" thru 5'4"	\$564	\$625	\$618	\$658	\$725	\$768
	5'8" thru 6'10"	\$626	\$695	\$687	\$732	\$808	\$858
4'0" thru 6'0"	2'0" thru 2'6"	\$498	\$551	\$544	\$578	\$636	\$673
	2'8" thru 3'4"	\$535	\$593	\$585	\$623	\$686	\$727
	3'6" thru 4'0"	\$572	\$635	\$627	\$668	\$736	\$780
	4'8" thru 5'4"	\$634	\$705	\$696	\$742	\$819	\$869
	5'8" thru 6'10"	\$696	\$775	\$765	\$816	\$903	\$959
6'2" thru 8'0"	2'0" thru 2'6"	\$597	\$663	\$654	\$697	\$769	\$816
	2'8" thru 3'4"	\$634	\$705	\$696	\$742	\$819	\$869
	3'6" thru 4'0"	\$671	\$747	\$737	\$787	\$869	\$923
	4'8" thru 5'4"	\$733	\$817	\$806	\$861	\$953	\$1,012
	5'8" thru 6'10"	\$795	\$887	\$875	\$935	\$1,036	\$1,102

NOTES:

1. Prices above include loose glazing beads, cut to length, with self-drilling attaching screws
2. Maximum sizes as listed
3. Minimum size 1'6" x 1'6"
4. DW frames have compression anchors in head and sill only. MU-Series frames are the same prices as shown.
5. Jambs are mitered with corner tabs
6. Prices for rabbeted and cased open
7. Cased open borrowed light does not include glazing bead
8. For borrowed lights other than sizes shown, price as lineal inch
9. G-90 galvanize - multiply "GALV" price by 1.25 (maximum height 120")

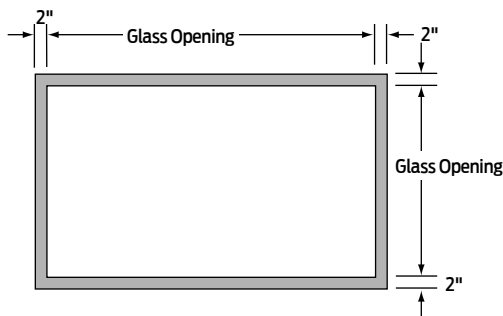

Prices subject to change without notice.

L-SERIES 1 3/4" PANELS

Panel Height	Gauges			
	Non-labeled		Labeled	
	L20	L18	L16	L18
3'0" Wide				
1'0"	\$502	\$512	\$534	\$686
2'0"	\$586	\$612	\$652	\$780
3'0"	\$672	\$707	\$770	\$876
4'0"	\$762	\$800	\$881	\$978
4'0" Wide				
1'0"	\$527	\$545	\$569	\$716
2'0"	\$644	\$676	\$730	\$846
3'0"	\$759	\$800	\$881	\$978
4'0"	\$873	\$934	\$1,043	\$1,108
6'0" Wide				
1'0"	\$586	\$612	\$652	\$838
2'0"	\$762	\$800	\$881	\$1,034
3'0"	\$931	\$999	\$1,116	\$1,225
4'0"	\$1,103	\$1,194	\$1,353	\$1,417
8'0" Wide				
1'0"	\$644	\$676	\$730	\$903
2'0"	\$873	\$934	\$1,043	\$1,160
3'0"	\$1,103	\$1,194	\$1,353	\$1,417
4'0"	\$1,328	\$1,450	\$1,670	\$1,679

CONSTRUCTION OPTIONS:

Per panel

GALVANNEALED STEEL (A-60)\$102

CORE MATERIAL OPTION

- Polystyrene\$38
- Polyurethane (non-labeled only)\$188

MARK NUMBERSN/C

HARDWARE OPTIONS: (Flush panels only)

Per prep

CLOSER REINF.\$36

FLUSHBOLT STRIKE PREP\$57

SURFACE BOLT\$36

NOTES:

1. L-Series panels have beveled top and bottom edges and recessed side channels with honeycomb core
2. Sizes other than listed are priced as the next larger size category
3. Labeled panels must be ordered and shipped with UL labeled transom frames
4. Labeled panels include closer reinf
5. UL label transom panels are for use with transom frames without transom bars only
 - 20 gauge panels not available labeled
 - Panels include attached astragal
6. Refer to the Parts Section for transom panel installation kits

3/8" AND 1/2" OPEN EDGE PANELS

Description	Base price per panel	Add per square foot					
		20 Gauge		18 Gauge		16 Gauge	
		CRS	GALV	CRS	GALV	CRS	GALV
NON-FIRE RATED PANELS							
Fiberboard core, 3/8" thick	128	not available		\$40	\$46	not available	
FIRE RATED LAMINATED PANELS							
Mineral board, 1/2" thick	128	\$46	\$53	\$47	\$54	\$51	\$56

NOTES:

1. Open edge panels are typically installed in side light or transom frames with glazing bead
2. Glazing beads are not included in panel price
3. When pricing, convert the total panel area to square feet:
 - Round both the length and width sizes to the next larger equal foot length
 - Example - for pricing, an 18" x 36" 3/8" thick 18 ga CRS panel would be sized as 2' x 3' = 6 sq. ft.
 - **Step #1** add base price for panel\$128
 - **Step #2** add for panel area (6 x \$40)\$240

Total panel cost = \$368

Prices subject to change without notice.

TABLE OF CONTENTS

FRAME PARTS100

Anchors..... 100

 Jamb – Wood and Steel Stud..... 100

 Jamb – Wood and Steel Stud..... 101

 Jamb – Masonry..... 102

 Base – All..... 103

 Drywall 104

 Miscellaneous 104

Closer Reinf..... 105

Corner Clip Reinf..... 105

Glazing Bead 106

Hardware Filler Plates 106

Hardware Reinf. Plates 107

Miscellaneous Frame Parts..... 108

 Hospital Stop Kits 108

 Lead Lining Clips..... 108

 Silencers 108

 Kerfed Frame Seals..... 108

 Splice Sleeves and Reinf..... 109

 Throat Fillers..... 109

 Transom Bar and Panel Kits..... 109

 Weatherstripping..... 109

DOOR PARTS 110

Astragals – “Z” Type..... 110

Astragals – 2 piece 111

Caps and Channels..... 112

Door Shelves and Filler Plates..... 113

Glass Trim 114

Miscellaneous Door Parts 117

 Hardware Reinf. 117

 Nosing – Doubler Acting Doors..... 117

 Sweeps 117

 Finishes and Coatings 118

 Paint – Primer 118

 Finishes and Coatings 118

 GRAINTECH™ – Stains..... 118

 Sample Products..... 118

PARTS ORDERING INFORMATION

1. Order all items as listed by **PACKAGE NUMBER** only. Use the **PART NUMBER** (located in the description column) only when a package number is not indicated or when ordering quantities less than the package quantity (See note 2).
2. The following procedure is required when ordering quantities less than the package quantity:
 - a. **A broken package charge of \$35 net will be applied to each line item**
 - b. Order by **PART NUMBER**
 - c. Where the **PART NUMBER** is listed as “not available” parts are only available in package quantities
3. Stock parts will ship either with the Stock or Express Stock program. Non-Stock (Shaded) parts will ship with our Standard 4-week program

Prices subject to change without notice.

JAMB ANCHORS - WOOD AND STEEL STUD (LOCK-IN)

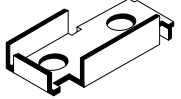
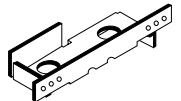
Item Description	Part Number	Package Number	Package Quantity	Package Price	Illustration
STEEL STUD – CLOSED					
For use on F-Series frames, 2" face only					
4 ³ / ₄ " JD (2 ¹ / ₂ " stud size)	not available	1011	100	240	
5 ³ / ₄ " JD (3 ⁵ / ₈ " stud size)	not available	1012			
5 ³ / ₄ " JD (3 ⁵ / ₈ " stud size)	not available	1019 Bulk 55 gallon drum	560	\$1,275	
6 ³ / ₄ " JD (3 ⁵ / ₈ " stud size)	not available	2611	100	\$270	
7 ³ / ₄ " JD	not available	2890	50	\$135	
8 ³ / ₄ " JD	not available	2612			
WOOD STUD					
For use on F-Series frames, 2" face only					
4 ³ / ₄ " JD	not available	1014	100	\$275	
5 ³ / ₄ " JD	not available	1015			
5 ³ / ₄ " JD	not available	1018 Bulk 55 gallon drum	450	\$1,151	
6 ³ / ₄ " JD	not available	1016	100	\$280	
7 ³ / ₄ " JD	not available	2891	50	\$145	
8 ³ / ₄ " JD	not available	1017			

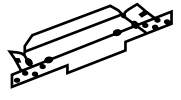

JAMB ANCHORS - WOOD AND STEEL STUD (LOCK-IN)

Item Description	Part Number	Package Number	Package Quantity	Package Price	Illustration
WOOD/STEEL STUD UNIVERSAL, ADJUSTABLE					
For use on F or MU-Series frames, 2" face only					
4 ¹ / ₂ " to 4 ³ / ₄ " JD	not available	2780	100	\$219	
4 ⁷ / ₈ " to 5" JD	not available	2781			
5 ¹ / ₈ " to 5 ¹ / ₄ " JD	not available	2782			
5 ³ / ₈ " to 5 ¹ / ₂ " JD	not available	2783			
5 ⁵ / ₈ " to 5 ³ / ₄ " JD	not available	2784			
5 ⁵ / ₈ " to 5 ³ / ₄ " JD	not available	1201	300	\$643	
5 ⁷ / ₈ " to 6"	not available	2785	100	\$219	
5 ⁷ / ₈ " to 6"	not available	1202	300	\$643	
6 ¹ / ₈ " to 6 ¹ / ₄ " JD	not available	2786	100	\$219	
6 ³ / ₈ " to 6 ¹ / ₂ " JD	not available	2787			
6 ⁵ / ₈ " to 6 ³ / ₄ " JD	not available	2788	50	\$124	
6 ⁷ / ₈ " to 7" JD	not available	2789			
7 ¹ / ₈ " to 7 ¹ / ₄ " JD	not available	2790			
7 ³ / ₈ " to 7 ¹ / ₂ " JD	not available	2791			
7 ⁵ / ₈ " to 7 ³ / ₄ " JD	not available	2792			
7 ⁵ / ₈ " to 7 ³ / ₄ " JD	not available	1203	200	\$484	
7 ⁷ / ₈ " to 8" JD	not available	2793	50	\$124	
8 ¹ / ₈ " to 8 ¹ / ₄ " JD	not available	2794	200	\$484	
8 ¹ / ₈ " to 8 ¹ / ₄ " JD	not available	1204			
8 ³ / ₈ " to 8 ¹ / ₂ " JD	not available	2795	50	\$124	
8 ⁵ / ₈ " to 8 ³ / ₄ "	not available	2796			
8 ⁷ / ₈ " to 9"	not available	2797			
9 ¹ / ₈ " to 9 ¹ / ₄ "	not available	2798			
9 ³ / ₈ " to 9 ¹ / ₂ "	not available	2799			

NOTE: Shaded items are non-stock

Prices subject to change without notice.

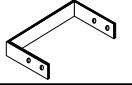
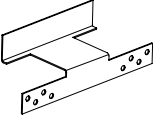
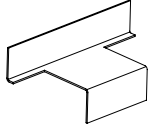
JAMB ANCHORS - WOOD AND STEEL STUD (WELD-IN)

Item Description	Part Number	Package Number	Package Quantity	Package Price	Illustration
"Z" STEEL STUD (WELD-IN) FOR SPECIAL PROFILE FRAMES					
For use on F and MU-Series frames					
Galv 6'0" length 1" x 7/8" x 1"	not available	5500	10	\$247	
WOOD STUD (WELD-IN)					
For use on F, FN and MU-Series frames					
For 3 1/2" stud width	not available	5508	50	\$279	
For 5 1/2" stud width	not available	5509			
WOOD STUD (WELD-IN)					
For use on F and MU-Series frames, 2" face only					
5" to 5 7/8" JD	not available	5511	50	\$172	
6" to 6 7/8" JD	not available	5512			
7" to 7 7/8" JD	not available	5513			
8" to 8 7/8" JD	not available	5514			
STEEL STUD (WELD-IN)					
For use on F and MU-Series frames, 2" face only					
5" to 5 7/8" JD	not available	5515	50	\$186	
6" to 6 7/8" JD	not available	5516			
7" to 7 7/8" JD	not available	5517			
8" to 8 7/8" JD	not available	5518			
STEEL AND WOOD STUD					
For use on FN-Series frames, 1" face only					
For single layer drywall	not available	5311	50	\$164	
For double layer drywall	not available	5310		\$226	

JAMB ANCHORS - WOOD AND STEEL STUD (WELD-IN)

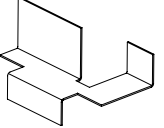
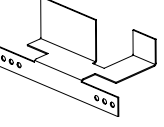
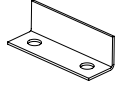
Item Description	Part Number	Package Number	Package Quantity	Package Price	Illustration
STEEL STUD - CLOSED (WELD-IN)					
For use on FE-Series frames					
5 3/4" JD head	not available	2032	24	\$223	
6 3/4" JD head	not available	2033			
7 3/4" JD head	not available	2034			
5 3/4" JD jamb	not available	2035	40	\$214	
6 3/4" JD jamb	not available	2036			
7 3/4" JD jamb	not available	2037			
WOOD STUD (WELD-IN)					
For use on FE-Series frames					
5 3/4" JD head	not available	2038	24	\$223	
6 3/4" JD head	not available	2047			
7 3/4" JD head	not available	2048			
5 3/4" JD jamb	not available	2049	40	\$214	
6 3/4" JD jamb	not available	2074			
7 3/4" JD jamb	not available	2075			
BASE (WELD-IN)					
For use on FE-Series frames					
1 3/8" face and greater	not available	2077	50	\$163	



Prices subject to change without notice.

NOTE: Shaded items are non-stock

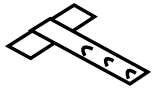
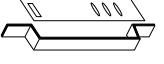
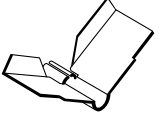
JAMB ANCHORS - MASONRY

Item Description	Part Number	Package Number	Package Quantity	Package Price	Illustration
WIRE MASONRY, 3/16" WIRE, GALVANNEALED					
For use on F, FE, DE, FN and MU-Series frames					
All JD	not available	2840	100	\$223	
All JD Anchors skidded (54 boxes, 100 anchors each)	not available	9915	5,400	\$11,764	
"T" MASONRY, 16 GAUGE GALVANNEALED					
For use on F Series, 2" face frames only					
5 ³ / ₄ " JD	not available	5100	50	\$162	
6 ³ / ₄ " JD	not available	5101			
7 ³ / ₄ " JD	not available	5102			
8 ³ / ₄ " JD	not available	5090			
YOKE AND STRAP MASONRY - WELD-IN					
For use on F, FE, DE, FN and MU-Series frames					
Set contains (1) each	not available not available	1095	50 Sets	\$405	
EXISTING OPENING - BUTTERFLY ANCHORS					
For use on F-Series double rabbeted frames					
4 ³ / ₄ " to 5 ⁷ / ₈ " JD	not available	4230	24	\$132	
4 ³ / ₄ " to 5 ⁷ / ₈ " JD	not available	4265	400	\$1,900	
6" to 7 ¹ / ₂ " JD	not available	4231	24	\$132	
7 ⁵ / ₈ " to 9 ¹ / ₈ " JD	not available	4232			

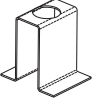
JAMB ANCHORS - EXISTING MASONRY (WELD-IN)

Item Description	Part Number	Package Number	Package Quantity	Package Price	Illustration	
EXISTING OPENING - WELD-IN EMA "HAT"						
For use on F, FE, DE and MU-Series frames						
Std 2" face + 5/8" stop	not available	5535	24	\$102		
Std 2" face + 5/8" stop	not available	5519	400	\$1,600		
Face + stop = 2" (F CO, FE)	not available	5532	24	\$102		
Std 1" face + 5/8" stop	not available	5536				
Std 1 1/2" face + 5/8" stop	not available	5533				
Std 1 3/4" face + 5/8" stop	not available	5534				
BOLT AND EXPANSION SHIELD						
For use on F, FE, DE and MU-Series frames						
3/8" x 5" sleeve anchor bolt (Std for 2" face)	not available	4162 (Q323 bolt)	24	\$192		
3/8" x 6" sleeve anchor bolt	not available	4199 (Q324 bolt)	24	\$192		
1 1/4" extender (field assm with 6" bolt for 4" face solution)	not available	4200 (Q325 bolt)	24	\$84		
For use on H and PW-Series Windstorm frames						
3/8" x 5" sleeve anchor bolt (Std for 2" face)	not available	4177 (Q326 bolt)	24	\$480		
3/8" x 6" sleeve anchor bolt	not available	4178 (Q327 bolt)	24	\$480		
1 1/4" extender (field assm with 6" bolt for 4" face solution)	not available	4200 (Q325 bolt)	24	\$84		

NOTE: Shaded items are non-stock

Prices subject to change without notice.

BASE ANCHORS

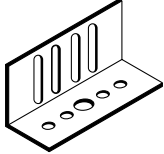
Item Description	Part Number	Package Number	Package Quantity	Package Price	Illustration
ADJUSTABLE BASE ANCHOR					
For use on F-Series frames					
4 ³ / ₄ " JD	not available	1067	100	\$300	
5 ³ / ₄ ", 6 ³ / ₄ " and 7 ³ / ₄ " JD	not available	1068			
5 ³ / ₄ ", 6 ³ / ₄ " and 7 ³ / ₄ " JD	not available	1020 Bulk 55 gallon drum	800	\$2,000	
8 ³ / ₄ " JD	not available	1069	50	\$150	

BASE ANCHORS

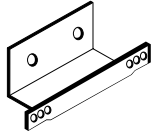
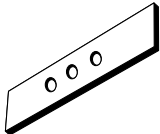
Item Description	Part Number	Package Number	Package Quantity	Package Price	Illustration
WOOD STUD BASE ANCHOR					
For use on F-Series double rabbeted frames					
4 ³ / ₄ " JD	not available	1075	100	\$251	
5 ³ / ₄ " JD	not available	1076			
6 ³ / ₄ " JD	not available	1077	25	\$106	
7 ³ / ₄ " JD	not available	2892			
8 ³ / ₄ " JD	not available	1078			
BASE ANCHOR ATTACHING STRAP					
For use on F-Series double rabbeted frames					
4 ³ / ₄ " JD	not available	1115	50	\$75	
5 ³ / ₄ " JD	not available	1116			
6 ³ / ₄ " JD	not available	1117			
7 ³ / ₄ " JD	not available	2874			
8 ³ / ₄ " JD	not available	1118			

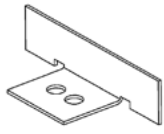
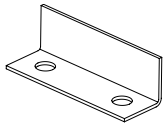

BASE ANCHORS (WELD-IN)

Item Description	Part Number	Package Number	Package Quantity	Package Price	Illustration
BASE ANCHOR					
For use on F and MU-Series double rabbeted frames					
4 ³ / ₄ " JD	not available	5520	100	\$300	
5 ³ / ₄ " JD	not available	5521			
6 ³ / ₄ " JD	not available	5522			
7 ³ / ₄ " JD	not available	5523			
8 ³ / ₄ " JD	not available	5524			
For use on F and FN-Series cased open frames					
F-Series all jamb depths	not available	2077	50	\$163	
FN-Series all jamb depths	not available	5526			

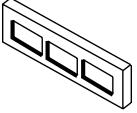

Prices subject to change without notice.

NOTE: Shaded items are non-stock

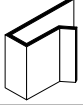
ANCHORS - DRYWALL

Item Description	Part Number	Package Number	Package Quantity	Package Price	Illustration
COMPRESSION ANCHOR					
For use on DW and K-Series frames, 2" face only					
Rabbeted frames	not available	3010	50	\$600	
Cased open frames	not available	3011			
BASE ANCHOR ATTACHING STRAP, FOR TWIST-IN BASE ANCHOR					
For use on DW-Series frames					
5 1/2" to 5 7/8" JD	not available	3012	50	\$300	
6 1/2" to 6 7/8" JD	not available	3013			
7 5/8" to 8 1/8" JD	not available	3014			
8 1/4" to 8 3/4" JD	not available	3015			
TWIST-IN BASE ANCHOR					
For use on DW-Series frames					
All jamb depths	not available	2848	100	\$175	
SECURITY JAMB ANCHOR					
For use on DW, K and MU-Series frames					
5/8" thick gypsum board	not available	2509	100	\$395	
1/2" thick gypsum board	not available	2510			
Two (2) layers 5/8" thick gypsum board	not available	2511			

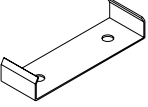
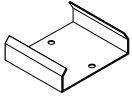
ANCHORS – MISCELLANEOUS



Item Description	Part Number	Package Number	Package Quantity	Package Price	Illustration
BASE ANCHORS FOR MULLION STICK ASSEMBLIES					
For use on F-Series sticks, 2" face only					
4 3/4" JD	not available	1085	25	\$306	
5 3/4" JD	not available	1086			
6 3/4" JD	not available	1087			
7 3/4" JD	not available	2875			
8 3/4" JD	not available	1088			
BASE ANCHORS - FOR SILL STICK ASSEMBLIES					
For use on F-Series sticks					
4 3/4" JD	not available	1099	10	\$186	
5 3/4" JD	not available	1100			
6 3/4" JD	not available	1101			
7 3/4" JD	not available	2877			
8 3/4" JD	not available	1102			
REMOVABLE VERTICAL MULLION ANCHOR, TOP AND BASE ASSEMBLY					
For use on F-Series frames, screws included					
Double rabbet	not available	2118	1 Set	\$46	
Single rabbet	not available	1104	1 Set	\$37	
CEILING STRUT ANCHOR					
For use on F-Series frames					
Adjustable for 8'0" to 12'0" ceiling heights	not available	1120	10	\$445	

NOTE: Shaded items are non-stock

Prices subject to change without notice.

CLOSER REINF. AND CORNER CLIPS

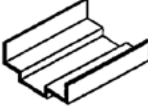
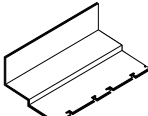
CLOSER REINF. AND CORNER CLIPS

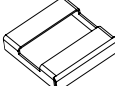
Item Description	Part Number	Package Number	Package Quantity	Package Price	Illustration
SLEEVE - FULL PROFILE					
For use on F, DW, K and MU-Series frames, 2" face only					
5 5/8" JD	not available	2595	6	\$194	
5 3/4" JD	not available	2199			
5 7/8" JD	not available	2596			
6 3/4" JD	not available	2542			
7 3/4" JD	not available	2879			
8 1/4" JD	not available	2469			
8 3/4" JD	not available	2468			
SLEEVE - HALF PROFILE, REINF. 115/16" RABBET ONLY					
For use on F, DW, K and MU-Series frames, 2" face only					
4 3/4" JD	not available	9612	6	\$123	
5 3/4" JD	not available	9616			
5 7/8" JD	not available	9617			
6 3/4" JD	not available	9624			
CORNER CLIPS					
F-Series frames, 2" face (25 right and 25 left)	not available	2910	25 Sets	\$120	
DW and K-Series frames, 2" face only	not available	2912	100	\$179	
F-Series frames, 4" face only	not available	2911	100	\$179	

Prices subject to change without notice.

NOTE: Shaded items are non-stock

GLAZING BEADS - FOR ALL STICK ASSEMBLIES, PRIME PAINTED

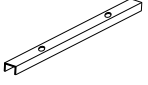
Item Description	Part Number	Package Number	Package Quantity	Package Price	Illustration
18 GAUGE, GALVANIZED, NO HOLES PUNCHED					
5/8" wide x 5/8" high x 120"	not available	4703	10	\$270	
1" wide x 5/8" high x 120"	not available	4704			
18 GAUGE, GALVANIZED, PRE-PUNCHED ON 9 1/2" CENTERS AND 3" FROM EACH END					
7/16" wide x 5/8" high x 120"	not available	4700	10	\$400	
5/8" wide x 5/8" high x 120"	not available	4701			
1" wide x 5/8" high x 120"	not available	4702			
18 GAUGE, GALVANIZED, PRE-PUNCHED ON 10" CENTERS AND 3" FROM EACH END					
1" wide x 3/4" high x 96"	not available	9658	10	\$400	
3/4" wide x 3/4" wide x 96"	not available	9659			

HARDWARE FILLER PLATES

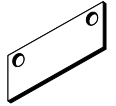
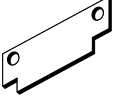
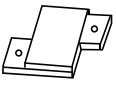



Item Description	Part Number	Package Number	Package Quantity	Package Price	Illustration
HINGE FILLER PLATES, SCREWS INCLUDED					
For use on F, FN, FE, DE, DW, K and MU-Series frames					
3 1/2" regular weight	not available	1191	12	132	
4 1/2" regular weight	not available	1192			
5" regular weight	not available	1193			
STRIKE FILLER PLATES, SCREWS INCLUDED					
For use on F, FN, DW, K and MU-Series frames					
ASA 4 7/8" ANSI-A115.1 and .2	not available	1194	12	\$99	
CYL 2 3/4" ANSI A115.3 for 1 9/16" rabbet	not available	1195			
CYL 2 3/4" ANSI A115.3 for 1 15/16" rabbet	not available	1196			
Reversible flushbolt strike filler	not available	5525	25	\$59	
VON DUPRIN 338 LATCH FILLER PLATE					
For use with retrofit application of Von Duprin Concealed Vertical Cable Device					
338 strike filler plate	not available	1205	4	\$279	

NOTE: Shaded items are non-stock

Prices subject to change without notice.

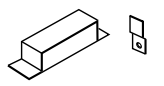
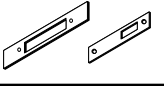
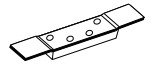
HARDWARE REINF. PLATES

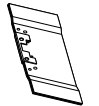
HARDWARE REINF. PLATES

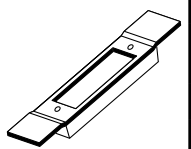
Item Description	Part Number	Package Number	Package Quantity	Package Price	Illustration	
ELECTRONIC POWER TRANSFER						
For use on 14 & 16 gauge frames with butt hinges						
Power transfer reinf. (Ex. EPT10)	not available	2930	6	\$133		
FLUSHBOLT STRIKE REINF.						
For use on F, FN, DW, K and MU-Series frames						
ANSI-A115.4 flushbolt strike, handed Two (2) reinf. plates and One (1) plaster guard per kit	not available	2040	4 Kits	\$86		
ANSI-A115.4 flushbolt strike, Reversible one (1) strike plate and One (1) reinf. and screws per kit		2899		\$82		
HINGE REINF. PLATES						
For use on F, FN, FE, DE, DW, K and MU-Series frames						
3 1/2" Regular weight, 10 gauge	not available	1183	40	\$560		
4 1/2" Universal, 7 gauge	not available	7001		\$400		
4 1/2" Universal, 7 gauge, bulk	not available	1141		200		\$1,323
5" Universal, 7 gauge	not available	9920		40		\$560
HIGH FREQUENCY REINF.						
F and DE-Series	not available	1188	12	\$112		
FE-Series	not available	1197				
HINGE REINF. PLATES - FULL JAMB DEPTH (4 1/2" X 4 1/2" HINGES ONLY)						
For use on F, DW, K and MU-Series frames						
5 3/4" JD	not available	3375	12	\$637		
6 3/4" JD	not available	3376		\$637		
7 3/4" JD	not available	3377		\$637		
8 3/4" JD	not available	3378		\$637		
HINGE SHIMS						
For use on F, DW, K and MU-Series frames						
For 4 1/2" hinge	not available	3529	200	\$339		
STRIKE REINF.						
For use on F, DW, K and MU-Series frames						
ASA 4 7/8" ANSI-A115.1 and .2 for 1 9/16" rabbet	not available	2907	20	\$140		
ASA 4 7/8" ANSI-A115.1 and .2 for 1 15/16" rabbet	not available	1189		\$140		
CYL 2 3/4" ANSI-A115.3 for 1 9/16" or 1 15/16" rabbet	not available	1190		\$140		
For use on FN Series frames						
ASA 4 7/8" ANSI-A115.1 and .2 for 1 9/16" rabbet	not available	2908	20	\$140		
ASA 4 7/8" ANSI-A115.1 and .2 for 1 15/16" rabbet	not available	1189		\$140		
CYL 2 3/4" ANSI-A115.3 for 1 9/16" or 1 15/16" rabbet	not available	2506		\$140		

Prices subject to change without notice.

NOTE: Shaded items are non-stock

HOSPITAL STOP KITS

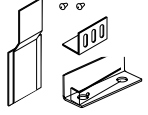
Item Description	Part Number	Package Number	Package Quantity	Package Price	Illustration
HOSPITAL STOP KIT FOR 45° CUT-OFF					
For use on F and FN Series frames					
5 1/2" high for 5 3/4" JD	not available	2369	5 Kits	\$150	
5 1/2" high for 6 3/4" JD	not available	2370			
5 1/2" high for 8 3/4" JD	not available	2217			

LEAD LINING CLIPS

Item Description	Part Number	Package Number	Package Quantity	Package Price	Illustration
For use on F, FN and MU-Series frames					
Clip only	not available	5507	30	144	

SILENCERS

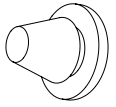
Item Description	Part Number	Package Number	Package Quantity	Package Price	Illustration
SILENCERS					
For use on F, FN, FE, DE, DW and MU-Series frames					
Open section frames	not available	Q146-100	100	\$55	
	not available	Q146-1000	1000	\$418	
Closed section frames	not available	Q146-2500	2500	\$810	
	not available	Q175-25	25	\$14	

KERFED FRAME SEALS (Fire rated up to 3 hours)

Item Description	Part Number	Package Number	Package Quantity	Package Price	Illustration
KERFED FRAME SEAL PIECES, BRONZE VINYL					
38" Lengths	not available	5371	10	\$55	
86" Lengths	not available	5376		\$130	
97" Lengths	not available	5377		\$148	

NOTE: Shaded items are non-stock



Prices subject to change without notice.

MISCELLANEOUS FRAME PARTS

FRAME

PARTS

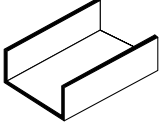
SPLICE SLEEVES

Item Description	Part Number	Package Number	Package Quantity	Package Price	Illustration
SPLICE SLEEVES - OPEN SECTION					
For use on F-Series frames, 2" face only					
4 ³ / ₄ " JD	not available	1128	6	\$111	
5 ³ / ₄ " JD	not available	1129			
6 ³ / ₄ " JD	not available	1130			
7 ³ / ₄ " JD	not available	2878			
8 ³ / ₄ " JD	not available	1131			
SPLICE SLEEVES - CLOSED SECTION					
For use on F-Series frames, 2" face only					
All jamb depths	not available	2462	12	\$103	



SPLICE REINF.

Item Description	Part Number	Package Number	Package Quantity	Package Price	Illustration
MULLION SPLICE CLIPS					
For use on F-Series frames, 2" face only					
All JD, double rabbeted 48 screws and 24 clips included	not available	1122	12 Sets	180	

THROAT FILLER

Item Description	Part Number	Package Number	Package Quantity	Package Price	Illustration
THROAT FILLER PIECE					
For use on DW, F and MU-Series frames					
87" long filler piece	not available	2518	50	738	

TRANSOM BAR AND PANEL KITS

Item Description	Part Number	Package Number	Package Quantity	Package Price	Illustration
K/D TRANSOM BAR CLIP					
For use on F-Series frames, 2" face only					
All jamb depths Four (4) angle brackets with screws	not available	2041	3 Sets	\$54	
ATTACHING KIT FOR 1 3/4" TRANSOM PANEL, NON-LABEL ONLY					
For use on F, FN, DW, K and MU-Series frames					
All jamb depths Two (2) angle brackets and Two (2) clips with screws	not available	2668	10	\$167	
MOUNTING CHANNELS FOR 1 3/4" TRANSOM PANELS, LABELED					
For use on F, FN and MU-Series frames					
96" long channels Four (4) verticals and Four (4) horizontal channels with screws	not available	4335	4	\$269	





WEATHERSTRIPPING

Item Description	Part Number	Package Number	Package Quantity	Package Price	Illustration
PS-074 WEATHERSTRIP PIECES, SELF ADHESIVE, BLACK VINYL					
36" lengths	not available	5372	50	\$240	
86" lengths	not available	5373		\$599	
120" lengths	not available	5374		\$759	

Prices subject to change without notice.

NOTE: Shaded items are non-stock

ASTRAGALS - OVERLAPPING "Z" TYPE FOR INACTIVE LEAF MOUNTING

Item Description	Part Number	Package Number	Package Quantity	Package Price	Illustration		
ASA 4 7/8" STRIKE AND ANSI FLUSHBOLT PREP							
For use on L, B, CE, A14 and T-Series doors							
6'8" R/L	not available	1285	1	\$91			
7'0" R	not available	1286					
7'0" L	not available	1287					
7'2" R	not available	1288					
7'2" L	not available	1289					
8'0" R @ 12" from top	not available	1292					
8'0" L @ 12" from top	not available	1293					
8'0" R @ 24" top and 12" bottom	not available	1294					
8'0" L @ 24" top and 12" bottom	not available	1295					
ASA 4 7/8" STRIKE PREP							
For use on L, B, CE, A14 and T-Series doors							
6'8" R/L	not available	1242	1	\$86			
7'0" R	not available	1243					
7'0" L	not available	1244					
7'2" R	not available	1245					
7'2" L	not available	1246					
8'0" R	not available	1269					
8'0" L	not available	1270					
SQUARE EDGE ASA 4 7/8" STRIKE AND ANSI FLUSHBOLT PREP							
For use on SL and SZ-Series doors							
6'8" R/L	not available	1304	1	\$91			
7'0" R	not available	1305					
7'0" L	not available	1306					
SQUARE EDGE ASA 4 7/8" STRIKE PREP							
For use on SL and SZ-Series doors							
6'8" R/L	not available	1274	1	\$86			
7'0" R	not available	1275					
7'0" L	not available	1276					
SQUARE EDGE BLANK							
For use on SL and SZ-Series doors							
7'0" Blank	not available	1310	1	\$59			

ASTRAGALS - OVERLAPPING "Z" TYPE FOR ACTIVE LEAF MOUNTING

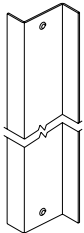
Item Description	Part Number	Package Number	Package Quantity	Package Price	Illustration
BLANK					
For use on L, B, CE, A14 and T-Series doors					
6'8" R	not available	15500	1	\$59	
6'8" L	not available	15501			
7'0" R	not available	15502			
7'0" L	not available	15503			
7'2" R	not available	15504			
7'2" L	not available	15505			
8'0" R	not available	15506			
8'0" L	not available	15507			

NOTES:

1. Z-Astragals are handed the same as the inactive leaf of pairs of doors.
2. Refer to the Steelcraft Tech Data Manual general section for handing illustrations and the Doors section for application details.
3. Astragals are prime painted, mounting screws are included.

NOTE: Shaded items are non-stock

Prices subject to change without notice.

2 PC ASTRAGALS - FOR ACTIVE LEAF MOUNTING RIGHT HAND APPLICATIONS

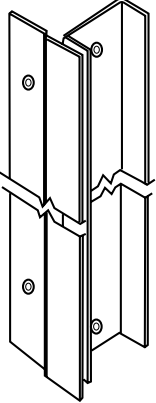
Item Description	Part Number	Package Number	Package Quantity	Package Price	Illustration	
ASA STRIKE AND FLUSHBOLT PREP						
For use on L-Series doors right hand application						
6'8"	not available	A001	1	\$119		
7'0"	not available	A003				
7'2"	not available	A004				
8'0"	not available	A006				
ASA STRIKE PREP ONLY						
6'8"	not available	A015	1	\$119		
7'0"	not available	A017				
7'2"	not available	A018				
8'0"	not available	A020				
FLUSHBOLT PREP ONLY						
6'8"	not available	A022	1	\$119		
7'0"	not available	A024				
7'2"	not available	A025				
8'0"	not available	A027				

2 PC ASTRAGALS - FOR ACTIVE LEAF MOUNTING LEFT HAND APPLICATIONS

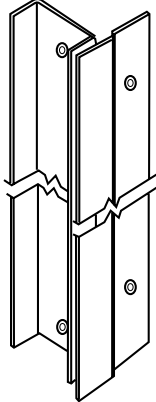
Item Description	Part Number	Package Number	Package Quantity	Package Price	Illustration	
ASA STRIKE AND FLUSHBOLT PREP						
For use on L-Series doors left hand application						
6'8"	not available	A029	1	\$119		
7'0"	not available	A031				
7'2"	not available	A032				
8'0"	not available	A034				
ASA STRIKE PREP ONLY						
6'8"	not available	A043	1	\$119		
7'0"	not available	A045				
7'2"	not available	A046				
8'0"	not available	A048				
FLUSHBOLT PREP ONLY						
6'8"	not available	A050	1	\$119		
7'0"	not available	A052				
7'2"	not available	A053				
8'0"	not available	A055				

ASTRAGALS - FLAT TYPE FOR ACTIVE LEAF MOUNTING

Item Description	Part Number	Package Number	Package Quantity	Package Price
FLAT BAR TYPE, 14 GAUGE FLAT STEEL, PRIME PAINTED, WITH MOUNTING HOLES AND SCREWS				
For use on L, B, CE, T and A14-Series doors				
7' 0" length x 1 1/2" wide	not available	15700	1	\$54
8' 0" length x 1 1/2" wide	not available	15750		

NOTES:

- Two piece astragals are handed the same as the inactive leaf of pairs of doors.
- Refer to the Steelcraft Tech Data Manual general section for handing illustrations and the Doors section for application details.
- Astragals are prime painted, mounting screws are included.

CAPS - STEEL TOP OR BOTTOM MOUNT

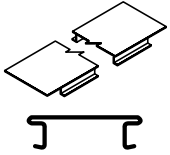
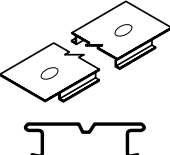
Item Description	Part Number	Package Number	Package Quantity	Package Price	Illustration
SNAP-IN TYPE, 24 GAUGE PRIME PAINTED					
For use on L, B, CE, A14 and T-Series doors					
2'0"	not available	9630	6	\$90	
2'4"	not available	9631			
2'6"	not available	9632			
2'8"	not available	9633			
2'10"	not available	9634			
3'0"	not available	9635			
3'4"	not available	9636			
3'6"	not available	9637			
3'8"	not available	9638			
3'10"	not available	9639			
4'0"	not available	9640			
SCREW-IN TYPE, 24 GAUGE PRIME PAINTED, DIMPLED FOR SCREW MOUNTING, SCREWS INCLUDED					
For use on L, B, CE, A14 and T-Series doors					
2'8"	not available	9633D	6	\$102	
3'0"	not available	9630D			
3'6"	not available	9632D			
4'0"	not available	9640D			
For use on SL and SZ-Series doors					
3'0"	not available	9656D	6	\$102	

CHANNELS

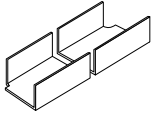
Item Description	Part Number	Package Number	Package Quantity	Package Price	Illustration	
TOP AND BOTTOM END CHANNELS, 14 GAUGE						
For use on L, B, A14 and T-Series doors (set contains 2 top and 2 bottom channel)						
3'0" door width	not available	4145	4	174		
4'0" door width	not available	4146		\$186		
REINF. CHANNEL, 18 GAUGE						
For cutouts in 13/4" doors						
15/8" wide x 93" long x 1/2" legs	not available	5501	10	\$329		



NOTE: Shaded items are non-stock

Prices subject to change without notice.

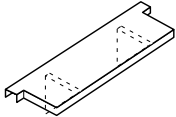
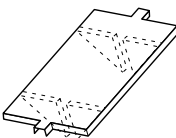
DUTCH DOOR SHELVES

Item Description	Part Number	Package Number	Package Quantity	Package Price	Illustration
HALF SHELF - 7" WIDE					
For use on L and B-Series doors					
2'0"	not available	1332	1	\$400	
2'4"	not available	1333			
2'6"	not available	1334			
2'8"	not available	1335			
2'10"	not available	4109			
3'0"	not available	1336			
3'4"	not available	1337			
3'6"	not available	1338			
3'8"	not available	1339			
3'10"	not available	1340			
4'0"	not available	1341			
FULL SHELF - 12" WIDE					
For use on L and B-Series doors					
2'0"	not available	4110	1	\$676	
2'4"	not available	4111			
2'6"	not available	4112			
2'8"	not available	4113			
2'10"	not available	4114			
3'0"	not available	4115			
3'4"	not available	4116			
3'6"	not available	4117			
3'8"	not available	4118			
3'10"	not available	4119			
4'0"	not available	4120			

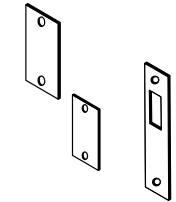
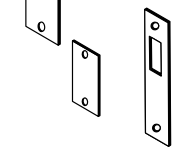
FILLER PLATES

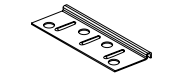
Item Description	Part Number	Package Number	Package Quantity	Package Price	Illustration
HINGE FILLER PLATES, 12 GAUGE, PRIME PAINTED					
For use with L, B, CE, A14, and T Series doors.					
4 1/2" regular weight	not available	1401	12	\$123	
LOCK EDGE FILLER PLATES					
161 edge (plastic) 1 1/8" wide x 2 1/4" long	not available	3293	12	\$105	
86 edge 1 1/8" wide x 8" long x 1/8" thick	not available	1404	6	\$96	
86 edge slotted filler allows for attachment of ASA strike	not available	2198		\$130	
LOCK FACE FILLER PLATES					
161 filler assembly (2 pieces)	not available	1405	2 Sets	\$52	
161 punch-out plate	not available	1422	100	\$275	
86 punch-out plate	not available	1424			
SQUARE EDGE HINGE FILLER PLATE, 20 GAUGE, PRIME PAINTED					
For use on SL and SZ-Series doors					
4 1/2" standard weight	not available	5531	100	\$180	





NOTES:

1. Dutch door shelves are prime painted. Mounting brackets and screws are included.

Prices subject to change without notice.

NOTE: Shaded items are non-stock

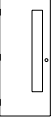
DEZIGNER TRIM KITS, standard sizes for 1/4" glass (3/8" glazing pocket)

Item Description	Exposed Glass Size	Part Number	Package Number	Package Quantity	Package Price	Illustration	
VISION AND NARROW LIGHTS							
V - vision light	9 1/2" x 9 1/2"	not available	10075	2 Kits	\$151		
N3 - narrow light	3" x 33"	not available	10164				
N4 - narrow light	4" x 25"	not available	10072				
N5 - narrow light	5" x 20"	not available	10165				
NARROW LIGHTS							
N for 6'8" high door	7 1/2" x 30 5/8"	not available	10066	2 Kits	\$229		
N for 7'0" high door	7 1/2" x 34 5/8"	not available	10068				
N for 7'2" high door	7 1/2" x 36 5/8"	not available	10069				
N for 8'0" high door	7 1/2" x 46 5/8"	not available	10071				
LONG NARROW LIGHTS							
LNL for 6'8" high door	7 1/2" x 58 1/8"	not available	10166	2 Kits	\$243		
LNL for 7'0" high door	7 1/2" x 62 1/8"	not available	10167				
LNL for 7'2" high door	7 1/2" x 64 1/8"	not available	10168				
LNL for 8'0" high door	7 1/2" x 74 1/8"	not available	10169				
HALF GLASS LIGHTS							
For 2'6" wide doors							
G for 6'8" high door	16 1/4" x 30 5/8"	not available	10012	2 Kits	\$243		
G for 7'0" high door	16 1/4" x 34 5/8"	not available	10014				
G for 7'2" high door	16 1/4" x 36 5/8"	not available	10015				
G for 8'0" high door	16 1/4" x 46 5/8"	not available	10170				
For 2'8" wide doors							
G for 6'8" high door	18 1/4" x 30 5/8"	not available	10018	2 Kits	\$251		
G for 7'0" high door	18 1/4" x 34 5/8"	not available	10020				
G for 7'2" high door	18 1/4" x 36 5/8"	not available	10021				
G for 8'0" high door	18 1/4" x 46 5/8"	not available	10171				
For 3'0" wide doors							
G for 6'8" high door	22 1/4" x 30 5/8"	not available	10030	2 Kits	\$265		
G for 7'0" high door	22 1/4" x 34 5/8"	not available	10032				
G for 7'2" high door	22 1/4" x 36 5/8"	not available	10033				
G for 8'0" high door	22 1/4" x 46 5/8"	not available	10172				
For 3'6" wide doors							
G for 6'8" high door	28 1/4" x 30 5/8"	not available	10042	2 Kits	\$287		
G for 7'0" high door	28 1/4" x 34 5/8"	not available	10044				
G for 7'2" high door	28 1/4" x 36 5/8"	not available	10045				
G for 8'0" high door	28 1/4" x 46 5/8"	not available	10173				
For 4'0" wide doors							
G for 6'8" high door	34 1/4" x 30 5/8"	not available	10060	2 Kits	\$306		
G for 7'0" high door	34 1/4" x 34 5/8"	not available	10062				
G for 7'2" high door	34 1/4" x 36 5/8"	not available	10063				
G for 8'0" high door	34 1/4" x 46 5/8"	not available	10174				
DEZIGNER TRIM KITS NON-STANDARD SIZE FOR 1/4" GLASS							
NET CUTOUT DIMENSION MUST BE SPECIFIED ON ORDER							
Special size light kit (see note #6)	As specified	not available	10217-SPCL	1 Kit	\$235		

NOTES:

- The parts above are standard size Dezigner Trim kits for L, B, SL and T-Series doors.
- 3/8" glazing pocket for use with 1/4" glass.
- Cutout of door and installation is by the distributor.
- The packages listed include parts for two (2) doors with mounting clips.
- Labeled doors require spacer channels (package #10332) when glass size exceeds 12" in either direction.
- Dezigner Trim light kits for non-standard sizes are ordered by the noted package number. Cutout width and height must also be specified.

NOTE: Shaded items are non-stock

Prices subject to change without notice.



GLASS TRIM - 1/2" GLASS

FOR DISTRIBUTOR INSTALLATION

DOOR

PARTS

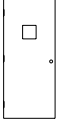
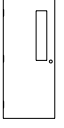
DEZIGNER TRIM KITS, standard sizes, for 1/2" glass (5/8" glazing pocket)

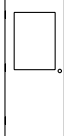
Item Description	Exposed Glass Size	Part Number	Package Number	Package Quantity	Package Price	Illustration	
VISION AND NARROW LIGHTS							
V - vision light	9 1/2" x 9 1/2"	not available	10175	2 Kits	\$165		
N3 - narrow light	3" x 33"	not available	10177				
N4 - narrow light	4" x 25"	not available	10176				
N5 - narrow light	5" x 20"	not available	10178				
NARROW LIGHTS							
N for 6'8" high door	7 1/2" x 30 5/8"	not available	10179	2 Kits	\$251		
N for 7'0" high door	7 1/2" x 34 5/8"	not available	10180				
N for 7'2" high door	7 1/2" x 36 5/8"	not available	10181				
N for 8'0" high door	7 1/2" x 46 5/8"	not available	10182				
LONG NARROW LIGHTS							
LNL for 6'8" high door	7 1/2" x 58 1/8"	not available	10183	2 Kits	\$265		
LNL for 7'0" high door	7 1/2" x 62 1/8"	not available	10184				
LNL for 7'2" high door	7 1/2" x 64 1/8"	not available	10185				
LNL for 8'0" high door	7 1/2" x 74 1/8"	not available	10186				
HALF GLASS LIGHTS							
For 2'6" wide doors							
G for 6'8" high door	16 1/4" x 30 5/8"	not available	10187	2 Kits	\$265		
G for 7'0" high door	16 1/4" x 34 5/8"	not available	10188				
G for 7'2" high door	16 1/4" x 36 5/8"	not available	10189				
G for 8'0" high door	16 1/4" x 46 5/8"	not available	10190				
For 2'8" wide doors							
G for 6'8" high door	18 1/4" x 30 5/8"	not available	10191	2 Kits	\$276		
G for 7'0" high door	18 1/4" x 34 5/8"	not available	10192				
G for 7'2" high door	18 1/4" x 36 5/8"	not available	10193				
G for 8'0" high door	18 1/4" x 46 5/8"	not available	10194				
For 3'0" wide doors							
G for 6'8" high door	22 1/4" x 30 5/8"	not available	10195	2 Kits	\$292		
G for 7'0" high door	22 1/4" x 34 5/8"	not available	10196				
G for 7'2" high door	22 1/4" x 36 5/8"	not available	10197				
G for 8'0" high door	22 1/4" x 46 5/8"	not available	10198				
For 3'6" wide doors							
G for 6'8" high door	28 1/4" x 30 5/8"	not available	10199	2 Kits	\$318		
G for 7'0" high door	28 1/4" x 34 5/8"	not available	10200				
G for 7'2" high door	28 1/4" x 36 5/8"	not available	10201				
G for 8'0" high door	28 1/4" x 46 5/8"	not available	10202				
For 4'0" wide doors							
G for 6'8" high door	34 1/4" x 30 5/8"	not available	10203	2 Kits	\$337		
G for 7'0" high door	34 1/4" x 34 5/8"	not available	10204				
G for 7'2" high door	3 1/4" x 36 5/8"	not available	10205				
G for 8'0" high door	34 1/4" x 46 5/8"	not available	10206				
DEZIGNER TRIM KITS NON-STANDARD SIZE FOR 1/2" GLASS							
NET CUTOUT DIMENSION MUST BE SPECIFIED ON ORDER							
Special size light kit (see note #6)	As specified	not available	10218-SPCL	1 Kit	\$235		

NOTES:

- The parts above are standard size Dezigner Trim kits for L, B, SL and T-Series doors.
- 5/8" glazing pocket for use with 1/2" glass.
- Cutout of door and installation is by the distributor.
- The packages listed include parts for two (2) doors with mounting clips.
- Labeled doors require spacer channels (package #10332) when glass size exceeds 12" in either direction.
- Dezigner Trim light kits for non-standard sizes are ordered by the noted package number. Cutout width and height must also be specified.

Prices subject to change without notice.

NOTE: Shaded items are non-stock

DEZIGNER TRIM PARTS

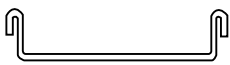
Item Description	Part Number	Package Number	Package Quantity	Package Price	Illustration
TRIM CLIPS AND SPACERS					
Mounting clips (for use with distributor cutout, 1/4" glass)	not available	10333	250	\$230	
Mounting clips (for use with distributor cutout, 1/2" glass)	not available	10335	250	\$230	
Label spacer channel	not available	10332	50	\$60	

CHANNEL AND BEAD TRIM PARTS

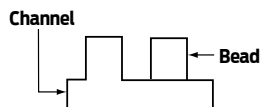
Item Description	Part Number	Package Number	Package Quantity	Package Price	Illustration
STEEL GLASS TRIM PIECES, FOR INSULATED GLASS THRU 5/8" THICK					
For use on L, B, A14 and T-Series doors					
93" length (3/4" high stops)	not available	3435	4 sets	\$289	

NOTE: Shaded items are non-stock

Prices subject to change without notice.

MISCELLANEOUS DOOR PARTS

DOOR

PARTS

HARDWARE REINF.

Item Description	Part Number	Package Number	Package Quantity	Package Price	Illustration
DEADLOCK KITS					
Strike reinf. Two (2) reinf. per kit	not available	2042	4 Kits	\$82	
Schlage B-Series kit Two (2) reinf. and One (1) spacer per kit	not available	2585		\$94	
FLUSHBOLT KITS					
ANSI Flushbolt reinf channel for use with or without astragal	not available	2453	2 Kits	\$31	
ANSI Flushbolt reinf angle for use with or without astragal	not available	2454	2 Kits	\$100	
HINGES					
4 1/2" Universal 7 gauge wire spacer included	not available	8531	40	\$410	
5" Universal 7 gauge wire spacer included	not available	9921			
LOCK REINF. BOXES					
161 x 2 3/4" backset	not available	4148	10	\$102	
86 x 2 3/4" backset	not available	4149	4	\$78	

NOSING - DOUBLE ACTING DOOR APPLICATIONS

Item Description	Part Number	Package Number	Package Quantity	Package Price	Illustration
EXTRUDED ALUMINUM					
For use on beveled edge doors only					
7'0" length	not available	2620	1	\$90	
8'0" length	not available	2621			

SWEEPS

Item Description	Part Number	Package Number	Package Quantity	Package Price	Illustration
FAS-SEAL DOOR BOTTOM SWEEP (NO PREP HOLES)					
Required for H Series Hurricane doors. May be used in the 3/4" pocket inverted bottom channel of any series door.					
Sweep for doors 3' wide max with (4) #10x3/4" self-drilling screws	not available	8424	25	\$351	
		5253	1	\$17	
Sweep for doors 4' wide max with (5) #10x3/4" self-drilling screws	not available	5251	25	\$446	
		5254	1	\$21	

SCREWS

Item Description	Part Number	Package Number	Package Quantity	Package Price
MISCELLANEOUS FASTENERS				
8 - 18 x 1 1/4" phillips OH type B Self drilling for glazing bead	not available	4169	144	\$106
1/4" - 20 phillips RHMS Type AB for adjustable base anchor	not available	4167		\$72
8 x 1/2" phillips Self drilling for astragals	not available	4168		\$52
8 - 18 x 5/8" phillips TSSMS type AB for UL DW and K-Series heads	not available	9930		

Prices subject to change without notice.

NOTE: Shaded items are non-stock

PAINT

Item Description	Package Number	Package Quantity	Package Price
PRIMER - STEELCRAFT BEIGE			
Beige: one (1) gallon can, water base	200	2 Cans (2 gallons total)	\$373
Beige: five (5) gallon pail, water base	205	2 Pails (10 gallons total)	\$1,243
Beige: 16 ounce spray can, 13 ounce net, solvent base	8421	12 Cans	\$315
Stainable primer, quart	8282	1	\$62
FRAME BACK COATING			
Asphaltic Coating*: one (1) gallon can	210	2 Cans (2 gallons total)	\$149
Asphaltic Coating*: five (5) gallon pail	211	1 Pail (5 gallons total)	\$326

* Bituminous Alternative (Modified Asphaltic Emulsion), Certified up to 3-hours in fire rated masonry applications, sprayable, VOC & HAPS Free

GRAINTECH™ STAINS

Item Description	Package Number	Package Quantity	Package Price
STANDARD COLOR STAINS			
Ash	8270	1 Quart	\$127
Birch	8271		
Mahogany	8272		
Maple	8273		
Oak	8274		
Walnut	8275		

Custom color setup charges given in Customer DOOR Options section

SAMPLE PRODUCTS

Item Description	Package Number	Package Quantity	Package Price
DOOR AND FRAME SAMPLES			
Suitcase samples	7170	1	\$207 Net
Typical wall section display	7152	1	\$60 Net
GRAINTECH™ door - Oak Finish	32	1	\$92 Net
Miniature B-Series door (16" x 18")	04500	1	\$132 Net
Dezigner Trim sample	7330	1	\$28 Net
Stainable steel panel - primed finish	5230	1	\$9 Net
GRAINTECH™ color chip set (6 colors)	4001	1	\$28 Net
CE-Series embossed panel section	7297	1	\$9 Net

NOTE: Shaded items are non-stock

Prices subject to change without notice.

TABLE OF CONTENTS

BLUE ASH..... 120

FRAME COMPONENTS..... 120

 F16-Series..... 120

 F16-Series Galvannealed 121

 F-14-Series Galvannealed 121

 FE16-Series Double Egress 122

 DW16-Series..... 122

WELDED 3 SIDED FRAMES 122

 F16-Series..... 122

STICK LENGTHS 123

 F16-Series..... 123

 F14-Series..... 123

FRAME KWIK-PAKS..... 124

 F16-Series 55 Pak Components 124

 DW16-Series 48 Pak Components 124

DOORS (UNITS AND KWIK-PAKS)..... 125

 L18-Series Flush Doors 125

 SL18-Series (Square Edge) Flush Doors..... 125

 SZ18-Series (Square Edge) Flush Doors..... 126

WEST COAST SERVICE CENTER 127

MODIFIED STOCK..... 127

 Frames..... 127

 Doors 128

FRAME COMPONENTS..... 129

 F16-Series..... 129

FRAME COMPONENTS..... 130

 F16-Series..... 130

 K16-Series 130

DOORS (UNITS)..... 131

 L18-Series Flush Doors 131

 L16-Series Flush Doors 132

 SZ18-Series Flush Doors..... 133

ORDERING INFORMATION

STOCK

- 1. Mark numbers on stock products are not available.
- 2. All stock hinge jambs and doors, as indicated, have a Warnock Hersey (WH) mylar label attached.
- 3. Standard loose jamb and base anchors are included with all **Stock Frame** orders. Sticks do not include anchors.
- 4. Items marked with (*) indicate **KWIK-PAK** availability.
- 5. Orders shall be placed using OEW or Steelcraft order forms.

KWIK-PAKS

- 1. KWIK-PAK products are at the following bulk rates:
 - Doors: 20 Pak prices are 5% less
 - 10 Pak prices are 3% less (Blue Ash Only)
 - Frames: 55 Pak prices are 8% less
 - 48 Pak prices are 5% less
- 2. Frames do not include jamb or base anchors. DW-Series frames have base anchor attaching strap installed.
- 3. Quoted discounts do not apply to the Kwik-Pak product discounts.
- 4. See KWIK-PAK page for exact bulk quantities by SKU.

WEST COAST STOCK AND MODIFIED STOCK

- 1. Orders for modified stock are limited to 20 doors and/or frames per order.
- 2. Quantities are subject to availability of each SKU. Please contact customer care for large quantity stock needs to confirm availability.
- 3. Welded 3-sided frames are included in the modified stock program.
- 4. For access to Blue Ash stock please order through the OEW RAPID program.

Prices subject to change without notice.

F16-SERIES JAMB COMPONENTS

Height	Description			5 ³ / ₄ "		7 ³ / ₄ "		8 ¹ / ₄ "		8 ³ / ₄ "	
				Part #	List \$	Part #	List \$	Part #	List \$	Part #	List \$
JAMB COMPONENTS											
6'8"	SJ	R	ASA	292*	\$112	713	\$121	7460	\$134	384	\$134
	SJ	R	BLK	7414	\$112	-	-	-	-	-	-
	SJ	L	ASA	295*	\$112	715	\$121	7461	\$134	387	\$134
	SJ	L	BLK	7415	\$112	-	-	-	-	-	-
	HJ	R	WH	294*	\$125	714	\$135	7462	\$150	386	\$150
	HJ	L	WH	297*	\$125	716	\$135	7463	\$150	389	\$150
7'0"	SJ	R	ASA	302*	\$118	717*	\$131	802*	\$139	390*	\$139
	SJ	R	BLK	303*	\$118	-	-	-	-	-	-
	SJ	L	ASA	305*	\$118	719*	\$131	806*	\$139	393*	\$139
	SJ	L	BLK	306*	\$118	-	-	-	-	-	-
	EJ	R†		7416	\$118	-	-	-	-	-	-
	EJ	L†		7417	\$118	-	-	-	-	-	-
	HJ	R	Less WH	760*	\$129	-	-	-	-	-	-
	HJ	L	Less WH	761*	\$129	-	-	-	-	-	-
	HJ	R	WH	304*	\$129	718*	\$143	803*	\$156	392*	\$156
7'2"	SJ	R	ASA	312	\$125	-	-	-	-	-	-
	SJ	L	ASA	315	\$125	-	-	-	-	-	-
	HJ	R	WH	314	\$138	-	-	-	-	-	-
	HJ	L	WH	317	\$138	-	-	-	-	-	-
8'0"	SJ	R	ASA	318*	\$148	-	-	-	-	-	-
	SJ	R	BLK	300	\$148	-	-	-	-	-	-
	SJ	L	ASA	320*	\$148	-	-	-	-	-	-
	SJ	L	BLK	301	\$148	-	-	-	-	-	-
	HJ	R	WH	319*	\$176	-	-	-	-	-	-
	HJ	L	WH	321*	\$176	-	-	-	-	-	-

F16-SERIES HEAD COMPONENTS

Width	Description			5 ³ / ₄ "		7 ³ / ₄ "		8 ¹ / ₄ "		8 ³ / ₄ "	
				Part #	List \$	Part #	List \$	Part #	List \$	Part #	List \$
HEAD COMPONENTS											
2'0"	HD			7420	\$53	-	-	-	-	-	-
2'4"	HD			7421	\$53	-	-	-	-	-	-
2'6"	HD			324*	\$53	-	-	-	-	-	-
2'8"	HD			325*	\$53	-	-	-	-	-	-
3'0"	HD			326*	\$53	706*	\$61	808*	\$70	400*	\$70
	HD	4" Face		334*	\$110	-	-	-	-	7479*	\$127
3'4"	HD			327	\$69	-	-	-	-	-	-
3'6"	HD			328	\$69	-	-	-	-	-	-
3'8"	HD			329	\$69	-	-	-	-	-	-
4'0"	HD			330*	\$69	-	-	7471	\$84	-	-
	HD	4" Face		7428	\$126	-	-	-	-	-	-
5'0"	HD	D		331	\$98	-	-	-	-	-	-
6'0"	HD	D		333*	\$108	-	-	7473	\$127	407	\$127
	HD	D	FB Strike	349*	\$165	-	-	-	-	-	-
	HD	D	4" Face	335	\$189	-	-	-	-	-	-
8'0"	HD	D		336	\$131	-	-	-	-	-	-

NOTES:

† End Jamb (EJ R/L) are handed the same as Blank Hinge Jambs (HJ R/L BLK), and will be invoiced as Blank Strike Jambs.

* Available as KWIK-PAK.

Prices subject to change without notice.

F16-SERIES GALVANNEALED JAMB COMPONENTS

Height	Description			5 ³ / ₄ " GALV		8 ³ / ₄ " GALV	
				Part #	List \$	Part #	List \$
JAMB COMPONENTS							
6'8"	SJ	R	ASA	685	\$132	-	-
	SJ	L	ASA	687	\$132	-	-
	HJ	R	WH	686	\$145	-	-
	HJ	L	WH	688	\$145	-	-
7'0"	SJ	R	ASA	681*	\$138	7527	\$159
	SJ	R	BLK	7510*	\$138	-	-
	SJ	L	ASA	682*	\$138	7529	\$159
	SJ	L	BLK	7511*	\$138	-	-
	HJ	R	WH	683*	\$149	7531	\$176
	HJ	L	WH	684*	\$149	7532	\$176
8'0"	SJ	R	ASA	7514	\$168	-	-
	SJ	L	ASA	7515	\$168	-	-
	HJ	R	WH	7516	\$196	-	-
	HJ	L	WH	7517	\$196	-	-

F16-SERIES GALVANNEALED HEAD COMPONENTS

Width	Description			5 ³ / ₄ " GALV		8 ³ / ₄ " GALV	
				Part #	List \$	Part #	List \$
HEAD COMPONENTS							
3'0"	HD			671*	\$66	-	-
	HD	4" Face		340*	\$123	7520	\$140
4'0"	HD			7501	\$82	-	-
	HD	4" Face		344	\$139	-	-
6'0"	HD	D		676	\$121	-	-
	HD	D 4" Face		347	\$202	-	-

F14-SERIES GALVANNEALED JAMB AND HEAD COMPONENTS

Height	Description			5 ³ / ₄ " GALV	
				Part #	List \$
JAMB COMPONENTS					
7'0"	SJ	R	ASA	904*	\$159
	SJ	L	ASA	906*	\$159
	HJ	R	WH	905*	\$173
	HJ	L	WH	907*	\$173
Width	Description			5 ³ / ₄ " GALV	
				Part #	List \$
HEAD COMPONENTS					
3'0"	HD			908*	\$86
	HD	4" Face		7533*	\$143
6'0"	HD	D 4" Face		7536	\$224

F14-SERIES GALVANNEALED KWIK-PAKS

Height	Description			5 ³ / ₄ " GALV	
				Part #	List \$
JAMBS - 2" FACE (55 PIECES PER PAK)					
7'0"	SJ	R	ASA	904	\$7,388
	SJ	L	ASA	906	\$7,388
	HJ	R	WH	905	\$8,096
	HJ	L	WH	907	\$8,096
Width	Description			5 ³ / ₄ " GALV	
				Part #	List \$
HEADS - 2" FACE (55 PIECES PER PAK)					
3'0"	HD			908	\$4,352
HEADS - 4" FACE (48 PIECES PER PAK)					
3'0"	HD	4" Face		7533	\$6,521

NOTES:

1. Stock frames listed as Galv are A-60 material.
2. * Available as KWIK-PAK.

Prices subject to change without notice.

FE16-SERIES DOUBLE EGRESS JAMB AND HEAD COMPONENTS

		5 ³ / ₄ "	
Height	Description	Part #	List \$
MITERED JAMB COMPONENTS			
6'8"	HJ R/R	7545	\$303
7'0"	HJ R/R	7546	\$306
		5 ³ / ₄ "	
Width	Description	Part #	List \$
MITERED HEAD COMPONENTS			
6'0"	HD R/R	7543	\$313
8'0"	HD R/R	7544	\$346

NOTES:

1. Door opening width for FE-Series heads is undersized 1/8".

DW16-SERIES JAMB AND HEAD COMPONENTS

		5 ⁵ / ₈ "		5 ⁷ / ₈ "		7 ¹ / ₈ "		8 ¹ / ₄ "	
Height	Description	Part #	List \$	Part #	List \$	Part #	List \$	Part #	List \$
JAMB COMPONENTS									
6'8"	SJ R ASA	519*	\$116	531*	\$116	-	-	-	-
	SJ L ASA	521*	\$116	533*	\$116	-	-	-	-
	HJ R WH	520*	\$127	532*	\$127	-	-	-	-
	HJ L WH	522*	\$127	534*	\$127	-	-	-	-
7'0"	SJ R ASA	523*	\$128	535*	\$128	754	\$140	7551*	\$145
	SJ L ASA	525*	\$128	537*	\$128	756	\$140	7552*	\$145
	HJ R Less WH	-	-	762*	\$136	-	-	-	-
	HJ L Less WH	-	-	763*	\$136	-	-	-	-
	HJ R WH	524*	\$136	536*	\$136	755	\$152	7553*	\$168
	HJ L WH	526*	\$136	538*	\$136	757	\$152	7554*	\$168
8'0"	SJ R ASA	-	-	540	\$150	-	-	-	-
	SJ L ASA	-	-	544	\$150	-	-	-	-
	HJ R WH	-	-	539	\$171	-	-	-	-
	HJ L WH	-	-	545	\$171	-	-	-	-
		5 ⁵ / ₈ "		5 ⁷ / ₈ "		7 ¹ / ₈ "		8 ¹ / ₄ "	
Height	Description	Part #	List \$	Part #	List \$	Part #	List \$	Part #	List \$
HEAD COMPONENTS									
2'6"	HD	-	-	541*	\$55	-	-	-	-
2'8"	HD	-	-	542*	\$55	-	-	-	-
3'0"	HD	530*	\$55	543*	\$55	759	\$71	7555*	\$82
4'0"	HD	-	-	547*	\$70	-	-	-	-
6'0"	HD	514	\$107	549*	\$107	-	-	-	-

F16-SERIES WELDED 3 SIDED FRAMES - 5³/₄" JAMB DEPTH

Width	Description					Part #	List \$	Pkg. Qty.
6'8" HIGH								
3'0"	RH	WH	ASA	RA/PA Reinf.	CRS	10212	\$8,660	20 total (10 RH, 10 LH)
	LH	WH	ASA	RA/PA Reinf.	CRS			
7'0" HIGH								
3'0"	RH	WH	ASA	PA Reinf. 4" face	GALV	10207	\$12,600	24 total (12 RH, 12 LH)
	LH	WH	ASA	PA Reinf. 4" face	GALV			
	LH	WH	ASA	RA/PA Reinf.	CRS	10211	\$10,632	24 total (12 RH, 12 LH)
	RH	WH	ASA	RA/PA Reinf.	CRS			
	LH	WH	ASA	RA/PA Reinf.	GALV	10214	\$11,904	24 total (12 RH, 12 LH)
	RH	WH	ASA	RA/PA Reinf.	GALV			
	RH	WH	ASA	PA Reinf. 4" face	GALV	7674	\$12,600	24
	LH	WH	ASA	PA Reinf. 4" face	GALV	7675	\$12,600	24
	RH	WH	ASA	RA/PA Reinf.	CRS	7676	\$10,632	24
LH	WH	ASA	RA/PA Reinf.	CRS	7677	\$10,632	24	

NOTES:

1. Welded 3 sided frame miters are face welded and finished and do not include jamb or base anchors.
2. One temporary spreader (shipping bar) included on each frame.
3. *Available as KWIK-PAK.

Prices subject to change without notice.

F16-SERIES OPEN SECTION STICKS (12'1" LENGTH)

TSF#	Description	4 ³ / ₄ "		5 ³ / ₄ "		5 ³ / ₄ " GALV		6 ³ / ₄ "		7 ³ / ₄ "		8 ¹ / ₄ "		8 ³ / ₄ "	
		Part #	List \$	Part #	List \$	Part #	List \$	Part #	List \$	Part #	List \$	Part #	List \$	Part #	List \$
OPEN SECTION - SQUARE CUT BOTH ENDS															
21	Blank rail	551	\$197	571	\$197	572	\$233	585	\$213	590	\$213	820	\$272	594	\$272
23	Blank rail – 4" face	-	-	573	\$263	596	\$294	-	-	613	\$285	-	-	620	\$361
40	Blank rail – cased open	-	-	583	\$197	-	-	-	-	-	-	-	-	-	-
24	R single hinge 6'8"	-	-	574	\$260	-	-	-	-	-	-	-	-	-	-
	L single hinge 6'8"	-	-	575	\$260	-	-	-	-	-	-	-	-	-	-
25	R single hinge 7'0"	-	-	576	\$260	-	-	-	-	-	-	-	-	-	-
	L single hinge 7'0"	-	-	577	\$260	-	-	-	-	-	-	-	-	-	-
26	R strike jamb ASA	-	-	578	\$218	-	-	-	-	-	-	-	-	-	-
	L strike jamb ASA	-	-	579	\$218	-	-	-	-	-	-	-	-	-	-
SILL SECTION - SQUARE CUT BOTH ENDS															
104	81/8" full sill	-	-	-	-	629	\$520	-	-	-	-	-	-	-	-
105	61/8" full sill	-	-	-	-	644	\$520	-	-	-	-	-	-	-	-
FILLER PLATES - SQUARE CUT BOTH ENDS (FOR CONVERTING OPEN TO CLOSED SECTION)															
22	Weld-in with stop	-	-	-	-	627	\$245	-	-	-	-	-	-	-	-
27	Weld-in w/o stop	-	-	-	-	628	\$245	-	-	-	-	-	-	-	-
89	Snap-in with stop	-	-	771	\$291	-	-	-	-	-	-	-	-	-	-

F16-SERIES CLOSED SECTION STICKS (10'6" LENGTHS)

TSF#	Description	4 ³ / ₄ "		5 ³ / ₄ "		5 ³ / ₄ " GALV		6 ³ / ₄ "		7 ³ / ₄ "		8 ¹ / ₄ "		8 ³ / ₄ "	
		Part #	List \$	Part #	List \$	Part #	List \$	Part #	List \$	Part #	List \$	Part #	List \$	Part #	List \$
CLOSED SECTION MULLION 10'6" OVERALL LENGTH - SQUARE CUT BOTH ENDS															
16	Blank mullion	5510	\$378	5691	\$378	5681	\$420	5841	\$432	5891	\$432	8211	\$480	59311	\$480
41	R single strike	-	-	2296	\$399	-	-	-	-	-	-	-	-	-	-
	L single strike	-	-	2304	\$399	-	-	-	-	-	-	-	-	-	-
43	R single hinge 7'0"	-	-	2297	\$441	-	-	-	-	-	-	-	-	-	-
	L single hinge 7'0"	-	-	2305	\$441	-	-	-	-	-	-	-	-	-	-

F16-SERIES CLOSED SECTION STICKS (OPENING HEIGHTS)

TSF#	Description	4 ³ / ₄ "		5 ³ / ₄ "		5 ³ / ₄ " GALV		6 ³ / ₄ "		7 ³ / ₄ "		8 ¹ / ₄ "		8 ³ / ₄ "	
		Part #	List \$	Part #	List \$	Part #	List \$	Part #	List \$	Part #	List \$	Part #	List \$	Part #	List \$
CLOSED SECTION MULLION 6'8" OVERALL LENGTH – NOTCHED FOR STOP AT HEAD															
10	R single strike 6'8"	-	-	564	\$280	-	-	-	-	-	-	-	-	-	-
	L single strike 6'8"	-	-	565	\$280	-	-	-	-	-	-	-	-	-	-
CLOSED SECTION MULLION 7'0" OVERALL LENGTH – NOTCHED FOR STOP AT HEAD															
20	Blank 7'0" mullion	-	-	570	\$271	-	-	-	-	-	-	-	-	-	-
14	R single hinge 7'0"	-	-	562	\$334	-	-	-	-	-	-	-	-	-	-
	L single hinge 7'0"	-	-	563	\$334	-	-	-	-	-	-	-	-	-	-
15	R single strike 7'0"	-	-	566	\$292	-	-	-	-	-	-	-	-	-	-
	L single strike 7'0"	-	-	567	\$292	-	-	-	-	-	-	-	-	-	-

F14-SERIES OPEN SECTION STICKS (12'1" LENGTHS)

TSF#	Description	4 ³ / ₄ "		5 ³ / ₄ "		5 ³ / ₄ " GALV		6 ³ / ₄ "		7 ³ / ₄ "		8 ¹ / ₄ "		8 ³ / ₄ "	
		Part #	List \$	Part #	List \$	Part #	List \$	Part #	List \$	Part #	List \$	Part #	List \$	Part #	List \$
OPEN SECTION 12'1" LENGTHS															
21	Blank rail	-	-	-	-	603	\$272	-	-	-	-	-	-	-	-

F14-SERIES CLOSED SECTION STICK (10'6" LENGTHS)

TSF#	Description	4 ³ / ₄ "		5 ³ / ₄ "		5 ³ / ₄ " GALV		6 ³ / ₄ "		7 ³ / ₄ "		8 ¹ / ₄ "		8 ³ / ₄ "	
		Part #	List \$	Part #	List \$	Part #	List \$	Part #	List \$	Part #	List \$	Part #	List \$	Part #	List \$
CLOSED SECTION MULLION 10'6" OVERALL LENGTH - SQUARE CUT BOTH ENDS															
16	Blank mullion	-	-	-	-	60211	\$473	-	-	-	-	-	-	-	-

NOTE: All items marked as GALV are A-60 material.

Prices subject to change without notice.

F16-SERIES JAMB KWIK-PAKS

Height	Description			5 ³ / ₄ "		5 ³ / ₄ " GALV		7 ³ / ₄ "		8 ¹ / ₄ "		8 ³ / ₄ "	
				Part #	List \$	Part #	List \$	Part #	List \$	Part #	List \$	Part #	List \$
JAMBS (55 PIECES PER PAK)													
6'8"	SJ	R	ASA	292	\$5,009	-	-	-	-	-	-	-	-
	SJ	L	ASA	295	\$5,009	-	-	-	-	-	-	-	-
	HJ	R	WH	294	\$5,667	-	-	-	-	-	-	-	-
	HJ	L	WH	297	\$5,667	-	-	-	-	-	-	-	-
7'0"	SJ	R	ASA	302	\$5,313	681	\$6,274	-	-	-	-	-	-
	SJ	R	BLK	303	\$5,313	7510	\$6,274	-	-	-	-	-	-
	SJ	L	ASA	305	\$5,313	682	\$6,274	-	-	-	-	-	-
	SJ	L	BLK	306	\$5,313	7511	\$6,274	-	-	-	-	-	-
	HJ	R	Less WH	760	\$5,870	-	-	-	-	-	-	-	-
	HJ	L	Less WH	761	\$5,870	-	-	-	-	-	-	-	-
	HJ	R	WH	304	\$5,870	683	\$6,831	-	-	-	-	-	-
	HJ	L	WH	307	\$5,870	684	\$6,831	-	-	-	-	-	-
8'0"	SJ	R	ASA	318	\$6,667	-	-	-	-	-	-	-	-
	SJ	L	ASA	320	\$6,667	-	-	-	-	-	-	-	-
	HJ	R	WH	319	\$8,083	-	-	-	-	-	-	-	-
	HJ	L	WH	321	\$8,083	-	-	-	-	-	-	-	-
JAMBS (48 PIECES PER PAK)													
7'0"	SJ	R	ASA	-	-	-	-	717	\$5,381	802	\$5,746	390	\$5,746
	SJ	L	ASA	-	-	-	-	719	\$5,381	806	\$5,746	393	\$5,746
	HJ	R	WH	-	-	-	-	718	\$5,928	803	\$6,521	392	\$6,521
	HJ	L	WH	-	-	-	-	720	\$5,928	807	\$6,521	395	\$6,521

F16-SERIES HEAD KWIK-PAKS

Height	Description			5 ³ / ₄ "		5 ³ / ₄ " GALV		7 ³ / ₄ "		8 ¹ / ₄ "		8 ³ / ₄ "	
				Part #	List \$	Part #	List \$	Part #	List \$	Part #	List \$	Part #	List \$
HEADS - 2" FACE (55 PIECES PER PAK)													
2'6"	HD			324	\$2,682	-	-	-	-	-	-	-	-
2'8"	HD			325	\$2,682	-	-	-	-	-	-	-	-
3'0"	HD			326	\$2,682	671	\$3,340	-	-	-	-	-	-
4'0"	HD			330	\$3,491	-	-	-	-	-	-	-	-
6'0"	HD	D		333	\$5,465	-	-	-	-	-	-	-	-
	HD	D	FB	349	\$8,349	-	-	-	-	-	-	-	-
HEADS - 2" FACE (48 PIECES PER PAK)													
3'0"	HD			-	-	-	-	706	\$2,782	808	\$3,192	400	\$3,192
HEADS - 4" FACE (48 PIECES PER PAK)													
3'0"	HD	4" face		334	\$5,016	340	\$5,609	-	-	-	-	-	-

DW16-SERIES JAMB KWIK-PAKS

Height	Description			5 ⁵ / ₈ "		5 ⁷ / ₈ "		8 ¹ / ₄ "	
				Part #	List \$	Part #	List \$	Part #	List \$
JAMBS (48 PIECES PER PAK)									
6'8"	SJ	R	ASA	519	\$5,141	531	\$5,141	-	-
	SJ	L	ASA	521	\$5,141	533	\$5,141	-	-
	HJ	R	WH	520	\$5,643	532	\$5,643	-	-
	HJ	L	WH	522	\$5,643	534	\$5,643	-	-
7'0"	SJ	R	ASA	523	\$5,689	535	\$5,689	7551	\$6,464
	SJ	L	ASA	525	\$5,689	537	\$5,689	7552	\$6,464
	HJ	R	Less WH	-	-	762	\$6,053	-	-
	HJ	L	Less WH	-	-	763	\$6,053	-	-
	HJ	R	WH	524	\$6,053	536	\$6,053	7553	\$7,513
	HJ	L	WH	526	\$6,053	538	\$6,053	7554	\$7,513

DW16-SERIES HEAD KWIK-PAKS

Height	Description			5 ⁵ / ₈ "		5 ⁷ / ₈ "		8 ¹ / ₄ "	
				Part #	List \$	Part #	List \$	Part #	List \$
HEADS (48 PIECES PER PAK)									
2'6"	HD			-	-	541	\$2,508	-	-
2'8"	HD			-	-	542	\$2,508	-	-
3'0"	HD			530	\$2,508	543	\$2,508	7555	\$3,739
4'0"	HD			-	-	547	\$3,192	-	-
6'0"	HD	D		-	-	549	\$4,879	-	-

NOTES:

1. Must be ordered in Kwik-Pak quantities for pricing.

Prices subject to change without notice.

L18-SERIES FLUSH DOORS - BEVELED EDGES AND HANDED

Width	Description				Part #	Unit Door \$	10 PAK \$	20 PAK \$
6'8" HIGH								
3'0"	R/LHR	161	C	WH	066	\$879	\$8,526	\$16,701
	L/RHR	161	C	WH	067			
	R/LHR	61L	C	WH	036			
	L/RHR	61L	C	WH	037			
	R/LHR	86ED	C	WH	076	\$927	\$8,992	\$17,613
	L/RHR	86ED	C	WH	077			
	R/LHR	RPD	C	WH	7602			
	L/RHR	RPD	C	WH	7603			
R/LHR	161	C	POLYS GALV	061	\$1,019	\$9,884	\$19,361	
L/RHR	161	C	POLYS GALV	062				
7'0" HIGH								
3'0"	R/LHR	161		WH	058	\$872	\$8,458	\$16,568
	L/RHR	161		WH	059			
	R/LHR	161	C	WH	068	\$908	\$8,808	\$17,252
	L/RHR	161	C	WH	069			
	R/LHR	61L	C	WH	038	\$908	\$8,808	\$17,252
	L/RHR	61L	C	WH	039			
	R/LHR	86ED	C	WH	082			
	L/RHR	86ED	C	WH	083			
	BLANK x BLANK	C (Top and Bottom)			070	\$944	\$9,157	\$17,936
	R/LHR	161	C	POLYS GALV	090			
	L/RHR	161	C	POLYS GALV	091	\$1,048	\$10,166	\$19,912
	R/LHR	86ED	C	POLYS GALV	084			
	L/RHR	86ED	C	POLYS GALV	085			
	R/LHR	INACTIVE	C ASA and FB	WH	7619			
	L/RHR	INACTIVE	C ASA and FB	WH	7620	\$1,003	\$9,729	\$19,057
	R/LHR	RPD	C	WH	088			
L/RHR	RPD	C	WH	089	\$956	\$9,273	\$18,164	
R/LHR	161	C	WH	064				
3'6"	L/RHR	161	C	WH	065	\$1,091	\$10,583	\$20,729
	R/LHR	161	C	WH	156			
4'0"	L/RHR	161	C	WH	157	\$1,200	\$11,640	\$22,800
	R/LHR	86ED	C	WH	7630			
	L/RHR	86ED	C	WH	7631			
	R/LHR	86ED	C	WH	7631			

NOTES:

1. Inactive doors require astragal. Order astragals from Parts Section of this price book.
2. The nomenclature designation "C" indicates closer reinf.
3. 4'0" 20 PAK doors are shipped as two (2) 10 PAK skids.

Prices subject to change without notice.

SZ18-SERIES FLUSH DOORS - SQUARE EDGES AND NON-HANDED

Width	Description					Part #	20 PAK \$
6'8" HIGH							
3'0"	R/L	61L	C - CLOSED TOP	WH	POLYS GALV	SZ001	\$11,157
	R/L	RPD	C - CLOSED TOP	WH	POLYS GALV	SZ002	\$12,094
	R/L	86ED	C - CLOSED TOP	WH	POLYS GALV	SZ003	\$11,157
	R/L	161	C - CLOSED TOP	WH	POLYS GALV	SZ004	\$11,157
	R/L	RPD	C	WH	HONEYCOMB CRS	SZ006	\$10,899
	R/L	86ED	C	WH	HONEYCOMB CRS	SZ007	\$9,962
	R/L	161	C	WH	HONEYCOMB CRS	SZ008	\$9,962
7'0" HIGH							
3'0"	R/L	61L	C - CLOSED TOP	WH	POLYS GALV	SZ010	\$11,539
	R/L	RPD	C - CLOSED TOP	WH	POLYS GALV	SZ011	\$12,475
	R/L	86ED	C - CLOSED TOP	WH	POLYS GALV	SZ012	\$11,539
	R/L	161	C - CLOSED TOP	WH	POLYS GALV	SZ013	\$11,539
	R/L	61L	C	WH	HONEYCOMB CRS	SZ014	\$10,331
	R/L	RPD	C	WH	HONEYCOMB CRS	SZ015	\$11,267
	R/L	86ED	C	WH	HONEYCOMB CRS	SZ016	\$10,331
	R/L	161	C	WH	HONEYCOMB CRS	SZ017	\$10,331

NOTES:

1. The nomenclature designation "C" indicates closer reinf.
2. The nomenclature designation "WH" indicates 1-1/2 hour Mylar fire label.
3. Only the Poly/Galv doors, noted above, have a closed top as standard.

Prices subject to change without notice.

WEST COAST SERVICE CENTER

AVAILABLE MODIFICATIONS TO STOCK FRAMES ONLY

FRAME MODS

STOCK

FRAME MOD PRICING Available on any West Coast Service Center stock frames

Item	Each \$	Available Options & Notes
STANDARD CONSTRUCTION OPTIONS		
*Label (per jamb)	Remove and install new metal or mylar label \$30	Metal: UL 3, 1-1/2, or 3/4 hour, 20 min; ITS/WHI 3, 1-1/2, or 3/4 hour, 20 min. Mylar: ITS/WHI 3 hr and 1-1/2 hr.
Welded 3-side frame	Face weld \$113	
	Continuous weld \$202	
Anchors (per anchor)	Existing Masonry -- Pierce & Dimple only \$9	Standard Quantities: - Jamb thru 7'1" (4 per jamb) - Jamb over 7'1 thru 8'9" (5 per jamb)
	EMA **Hat anchor -- P&D, welded-in with bolts \$30	
	EMA Tube & Strap -- P&D, welded-in with bolts \$40	
	Stud Wall -- weld-in (typ 3 per jamb) \$11	
Jamb: Weld-in wood, Flush steel, Wood strap, Recessed Z, Compression jamb Base: Fixed base, Weld-in Wood stud base, L-shaped base		
Frame Packaging	Polystyrene mortar guard strips \$68	Price per frame
STANDARD HARDWARE OPTIONS		
Hinge preps	14 gauge Continuous hinge reinforcement \$132	Available on blank jambs only
Strike preps	Deadlock / ASA strike prep \$65	Non-lip, includes dust (mortar) box. CYL-48, CYL-60; ASA: Cat. #535: S43 (Corbin Russwin 424F83, Falcon "D" Series - P10018, Sargent 404 Schlage 10-055 Yale 541); S40 (Best 38HSI, Corbin Russwin 424F83, Sargent 405 Yale 30S); S27 (Best 38SHI, Corbin Russwin 381F94, Sargent 405, Yale 30S)
	RPD Rim Panic Strike prep \$31	14ga, 44-9/16" top of reinforcement to bottom of frame
	SVRPD (Surface Vertical Rod) prep \$31	14ga, welded to soffit of frame header
	Universal (reversible) Flush Bolt Strike prep \$71	Only available on 6'0" heads. Includes mortar box.
Closers	RA (Regular arm), PA (Parallel arm), or Top Jamb \$31	14ga. reinf.
	Overhead Stop and Holder \$106	Glynn Johnson 100 series and ABH 1000 series only
Electric hardware preps	Power transfer prep (EPT) \$141	Von Duprin EPT2 and EPT10 only. Includes mortar box.
	Electric Hinge prep \$57	Reinforcement supports all manufacturers/products
	Electric Strike prep \$107	Von Duprin (4211, 4212, 5100, 6210, 6211, 6400) Adams Rite (7100, 7128, 7140, 7170, 7240, 7270, 7440, 7400/7401, 7900) Dorma (ES84, ES72, ES86, ES-95, ES96F, ES-111-A, ES112-B) Folger Adams (112, 202, 502, 712, 712-75, 732) HES (732, 742-75, 1003 SERIES, 1006 SERIES, 4500, 5000-501, 5200-501, 7000-701, 7001, 7501, 8000/8300, 8500) RCI (F1114, F2164), Rofu (1702), Trine (4100)
	Door position switch prep \$57	Schlage Elect. 679-05HM 1" Round concealed SPDT, 7764 Rect concealed, 7766 Rect Surface Sentrol 1076/1078 Series concealed models for 1" and 3/4", round, open/closed, SPDT, DPDT, and N/O

NOTES:

- * Refer to TD Manual for all labeled approvals. The included WHI label must be relabeled if a different fire label is required or requested.
- ** Default anchor if no choice is specified

Prices subject to change without notice.

DOOR MOD PRICING Available on any West Coast Service Center stock doors

Item	Each \$	Available Options & Notes	
STANDARD CONSTRUCTION OPTIONS			
Glass Lights/ louvers (price per cutout)	Glass light/louver cutout only	\$105	GS, NS, VS for lights and louvers. No trim available on mods. Specify DCS (door cutout size) and location.
	Glass light/louver cutout with *channels	\$194	
	Full glass light cutout with *channels	\$300	FGS lights. No trim available on mods. Specify DCS and location.
	Door Viewer	\$40	
Door Edges	Filled Edge Seam	\$201	
Top or Bottom Caps	Screw-in	\$49	
	Sealed	\$214	
*Label (per leaf)	Remove and Install new label (N/A for doors over 7'2" tall with labels over 20 min)	\$58	Metal: UL 3, 1-1/2, 1, 3/4 hr, 20 min; Mylar: ITS/WHI 3, 1-1/2, 1, 3/4 hr
	Add label to doors over 7'2" tall (includes required tack welds required for labels over 20 min)	\$187	Metal: UL 3, 1-1/2, 1, 3/4 hr, Mylar: ITS/WHI 3, 1-1/2, 1, 3/4 hr
STANDARD HARDWARE OPTIONS			
Locks - Primary	86ED lock function holes	\$89	Schlage L9010, L9040, L9050, L9070/L9080, L9453 only Falcon MA101, MA301, MA581, MA541, MA561, and MA371
**Locks - Secondary	Deadlock prep	\$150	161-48 only
Strikes - Secondary	Deadlock strike prep at 48" CL from frame bottom	\$150	Cat. #535: NA1, NA3 (w/ astragal) and NW1, NW3 (w/o astragal)
***Exit devices	Mortise or RIM exit device function holes	\$89	
Door Edge Prep	Attached Z-astragal with ASA & FB (L Series Door only). Includes astragal.	\$303	only available 12" from top and bottom to center of FB for 6'8, 7'0 and 8'0 heights (FB 24" from top avail on 8'0 door)
	Attached Flat bar astragal. Includes astragal.	\$225	Includes notching astragal for strike lip clearance
	Inactive leaf - Add ASA prep to stock 86ed	\$102	ANSI A115.1 & A115.2; CL 40-5/16" from frame bottom
	Inactive leaf - Add FB prep (top & bottom) to 86ed	\$225	
Electric hardware preps	Power transfer prep (EPT)	\$168	EPT2, EPT10 only. No raceways provided through mod stock.
	Electric hinge prep	\$30	Reinforcement supports all manufacturers/products
	Door position switch prep	\$33	Schlage Electronics 679-05HM 1" round concealed SPDT Sentrol 1076/1078 Series concealed models for 1" and 3/4" round, pen/closed, SPDT, DPDT, and N/O

NOTES:

- * Refer to TD Manual for all labeled approvals. Standard 1.5 hr WHI labels must be replaced if requirements change based on modifications.
- ** One additional lock allowed per opening.
- *** Exit devices should mod an RPD door as the active leaf and an 86ED through bolted, if an inactive ASA strike is needed.
- Strike prep available as mod to 86ED stock doors for inactive leaf.
- Use RPD door for push/pull (blank lock side).
- Surface flushbolt reinforcement not available.

Prices subject to change without notice.

F16-SERIES JAMB COMPONENTS

Height	Description			5-3/4"		6-1/4"		7-3/4"		8-1/4"	
				Part #	List \$	Part #	List \$	Part #	List \$	Part #	List \$
JAMB COMPONENTS											
6'8"	SJ	R	ASA	292	\$112	19044	\$121	713	\$121	7460	\$134
	SJ	R	RPD	19451	\$141	19457	\$150	19467	\$150	19485	\$163
	SJ	R	BLK	7414	\$112	-	-	-	-	-	-
	SJ	L	ASA	295	\$112	19045	\$121	715	\$121	7461	\$134
	SJ	L	RPD	19452	\$141	19458	\$150	19469	\$150	19487	\$163
	SJ	L	BLK	7415	\$112	-	-	-	-	-	-
	HJ	R	WH	294	\$125	19046	\$135	714	\$135	7462	\$150
HJ	L	WH	297	\$125	19047	\$135	716	\$135	7463	\$150	
7'0"	SJ	R	ASA	302*	\$118	19048	\$131	717	\$131	802	\$139
	SJ	R	RPD	19453	\$147	19459	\$160	19473	\$160	19492	\$168
	SJ	R	BLK	303	\$118	-	-	-	-	-	-
	SJ	L	ASA	305*	\$118	19049	\$131	719	\$131	806	\$139
	SJ	L	RPD	19454	\$147	19460	\$160	19475	\$160	19494	\$168
	SJ	L	BLK	306	\$118	-	-	-	-	-	-
	EJ	R†		-	-	-	-	19685	\$131	-	-
	EJ	L†		-	-	-	-	19686	\$131	-	-
	HJ	R	WH	304*	\$129	19052	\$143	718	\$143	803	\$156
	HJ	L	WH	307*	\$129	19053	\$143	720	\$143	807	\$156
8'0"	SJ	R	ASA	318	\$148	19463	\$153	19480	\$153	19499	\$168
	SJ	R	RPD	19455	\$177	19464	\$182	19481	\$182	19700	\$197
	SJ	L	ASA	320	\$148	19465	\$153	19482	\$153	19701	\$168
	SJ	L	RPD	19456	\$177	19466	\$182	19483	\$182	19702	\$197
	HJ	R	WH	319	\$176	19461	\$180	19478	\$180	19497	\$192
	HJ	L	WH	321	\$176	19462	\$180	19479	\$180	19498	\$192

F16-SERIES HEAD COMPONENTS

Width	Description			5-3/4"		6-1/4"		7-3/4"		8-1/4"	
				Part #	List \$	Part #	List \$	Part #	List \$	Part #	List \$
HEAD COMPONENTS											
2'6"	HD			324	\$53	19706	\$61	19713	\$61	19721	\$70
2'8"	HD			325	\$53	19707	\$61	19714	\$61	19722	\$70
2'10"	HD			19703	\$53	19708	\$61	19715	\$61	19723	\$70
3'0"	HD			326*	\$53	19062	\$61	706	\$61	808	\$70
	HD	4" face		334	\$110	-	-	-	-	-	-
3'6"	HD			328	\$69	19709	\$78	19717	\$78	19725	\$84
4'0"	HD			330	\$69	19710	\$78	19718	\$78	7471	\$84
5'0"	HD	D		331	\$98	19711	\$104	19719	\$104	19727	\$113
6'0"	HD	D		333	\$108	19586	\$116	19587	\$116	7473	\$127
8'0"	HD	D		336	\$131	19712	\$141	19720	\$141	19729	\$157

F16-SERIES JAMB AND HEAD KWIK-PAKS

Height	Description			5-3/4"	
				Part #	List \$
JAMBS - 2" FACE (55 PIECES PER PAK)					
7'0"	SJ	R	ASA	302	\$5,313
	SJ	L	ASA	305	\$5,313
	HJ	R	WH	304	\$5,870
	HJ	L	WH	307	\$5,870
Width	Description			5-3/4"	
				Part #	List \$
HEADS - 2" FACE (55 PIECES PER PAK)					
3'0"	HD			326	\$2,682

NOTES:

- † End Jambs (EJ R/L) handed same as Blank Hinge Jambs (HJ R/L BLK), and will be invoiced as Blank Strike Jambs.
- * Available as KWIK-PAK.
- Stock uses Steelcraft hinge and lock locations.

Prices subject to change without notice.

F16-SERIES WELDED 3 SIDED FRAMES - 5 3/4" JAMB DEPTH

Width	Description					Part #	List \$	Pkg. Qty.
7'0" HIGH								
3'0"	LH	WH	ASA	RA/PA Reinf.	CRS	10211	\$10,632	24 total (12 RH, 12 LH)
	RH	WH	ASA	RA/PA Reinf.	CRS			
	RH	WH	ASA	RA/PA Reinf.	CRS	7676	\$10,632	24
	LH	WH	ASA	RA/PA Reinf.	CRS	7677	\$10,632	24

K16-SERIES JAMBS AND HEAD

Height	Description			5-7/8"		6-1/4"		8-1/4"	
				Part #	List \$	Part #	List \$	Part #	List \$
JAMB COMPONENTS									
6'8"	SJ	R	ASA	19156	\$113	19761	\$126	19236	\$136
	SJ	R	RPD	19730	\$142	19736	\$155	19746	\$165
	SJ	L	ASA	19157	\$113	19179	\$126	19237	\$136
	SJ	L	RPD	19731	\$142	19737	\$155	19747	\$165
	HJ	R	WH	19158	\$124	19180	\$144	19238	\$157
	HJ	L	WH	19159	\$124	19181	\$144	19239	\$157
7'0"	SJ	R	ASA	19160	\$125	19182	\$137	19240	\$142
	SJ	R	RPD	19732	\$154	19738	\$166	19748	\$171
	SJ	L	ASA	19161	\$125	19183	\$137	19241	\$142
	SJ	L	RPD	19733	\$154	19739	\$166	19749	\$171
	HJ	R	WH	19164	\$133	19186	\$149	19242	\$165
	HJ	L	WH	19165	\$133	19187	\$149	19243	\$165
8'0"	SJ	R	ASA	19166	\$147	19740	\$160	19750	\$168
	SJ	R	RPD	19734	\$176	19741	\$189	19751	\$197
	SJ	L	ASA	19167	\$147	19742	\$160	19752	\$168
	SJ	L	RPD	19735	\$176	19743	\$189	19753	\$197
	HJ	R	WH	19168	\$168	19744	\$187	19754	\$201
	HJ	L	WH	19169	\$168	19745	\$187	19755	\$201

Width	Description		5-7/8"		6-1/4"		8-1/4"	
			Part #	List \$	Part #	List \$	Part #	List \$
HEAD COMPONENTS								
2'6"	HD		19756	\$55	19194	\$71	19768	\$82
2'8"	HD		19757	\$55	19195	\$71	19769	\$82
3'0"	HD		19174	\$55	19196	\$71	19252	\$82
3'6"	HD		19758	\$70	19197	\$86	19253	\$93
4'0"	HD		19759	\$70	19198	\$86	19254	\$93
5'0"	HD	D	19760	\$107	19766	\$115	19772	\$128
6'0"	HD	D	19177	\$107	19199	\$115	19255	\$128

NOTES:

1. † End Jambs (EJ R/L) handed same as Blank Hinge Jambs (HJ R/L BLK), and will be invoiced as Blank Strike Jambs.
2. * Available as KWIK-PAK.
3. Stock uses Steelcraft hinge and lock locations.

Prices subject to change without notice.

L18-SERIES FLUSH DOORS - BEVELED EDGES AND HANDED

Width	Description					6'8"		7'0"		'8'0" non-label	
						Part #	Unit \$	Part #	Unit \$	Part #	Unit \$
2'6"	R/LHR	161	C	WH	HONEYCOMB / CRS	19606	\$871	19630	\$902	19644	\$1,200
	L/RHR	161	C	WH	HONEYCOMB / CRS	19607	\$871	19631	\$902	19645	\$1,200
	R/LHR	86ED	C	WH	HONEYCOMB / CRS	19608	\$871	19632	\$902	19646	\$1,200
	L/RHR	86ED	C	WH	HONEYCOMB / CRS	19609	\$871	19633	\$902	19647	\$1,200
	R/LHR	RPD	C	WH	HONEYCOMB / CRS	19610	\$919	19634	\$950	19648	\$1,248
	L/RHR	RPD	C	WH	HONEYCOMB / CRS	19611	\$919	19635	\$950	19649	\$1,248
2'8"	R/LHR	161	C	WH	HONEYCOMB / CRS	19612	\$871	19636	\$902	19650	\$1,200
	L/RHR	161	C	WH	HONEYCOMB / CRS	19613	\$871	19637	\$902	19651	\$1,200
	R/LHR	86ED	C	WH	HONEYCOMB / CRS	19614	\$871	19638	\$902	19652	\$1,200
	L/RHR	86ED	C	WH	HONEYCOMB / CRS	19615	\$871	19639	\$902	19653	\$1,200
	R/LHR	RPD	C	WH	HONEYCOMB / CRS	19616	\$919	19640	\$950	19654	\$1,248
	L/RHR	RPD	C	WH	HONEYCOMB / CRS	19617	\$919	19641	\$950	19655	\$1,248
3'0"	R/LHR	61L	C	WH	HONEYCOMB / CRS	036	\$879	038	\$908	-	-
	L/RHR	61L	C	WH	HONEYCOMB / CRS	037	\$879	039	\$908	-	-
	R/LHR	161	C	WH	HONEYCOMB / CRS	066	\$879	068	\$908	19674	\$1,231
	L/RHR	161	C	WH	HONEYCOMB / CRS	067	\$879	069	\$908	19675	\$1,231
	R/LHR	86ED	C	WH	HONEYCOMB / CRS	076	\$879	082	\$908	19676	\$1,231
	L/RHR	86ED	C	WH	HONEYCOMB / CRS	077	\$879	083	\$908	19677	\$1,231
	R/LHR	RPD	C	WH	HONEYCOMB / CRS	7602	\$927	088	\$956	19678	\$1,279
	L/RHR	RPD	C	WH	HONEYCOMB / CRS	7603	\$927	089	\$956	19679	\$1,279
	R/LHR	INACTIVE	C ASA & FB	WH	HONEYCOMB / CRS	-	-	7619	\$1,003	-	-
	L/RHR	INACTIVE	C ASA & FB	WH	HONEYCOMB / CRS	-	-	7620	\$1,003	-	-
	R/LHR	WIDE INACT	C ASA & FB W/ TABS	WH	HONEYCOMB / CRS	-	-	19687	\$1,003	-	-
	L/RHR	WIDE INACT	C ASA & FB W/ TABS	WH	HONEYCOMB / CRS	-	-	19688	\$1,003	-	-
	R/LHR	161	C	WH	POLYS / GALV	-	-	090	\$1,048	-	-
	L/RHR	161	C	WH	POLYS / GALV	-	-	091	\$1,048	-	-
	R/LHR	86ED	C	WH	POLYS / GALV	-	-	084	\$1,048	-	-
	L/RHR	86ED	C	WH	POLYS / GALV	-	-	085	\$1,048	-	-
	R/LHR	RPD	C	WH	POLYS / GALV	-	-	092	\$1,096	-	-
	L/RHR	RPD	C	WH	POLYS / GALV	-	-	093	\$1,096	-	-
R/LHR	RPD	C & CH (undersized 5/16")	WH	POLYS / GALV	-	-	19642	\$1,096	-	-	
L/RHR	RPD	C & CH (undersized 5/16")	WH	POLYS / GALV	-	-	19643	\$1,096	-	-	
3'6"	R/LHR	161	C	WH	HONEYCOMB / CRS	19618	\$1,049	064	\$1,091	19656	\$1,373
	L/RHR	161	C	WH	HONEYCOMB / CRS	19619	\$1,049	065	\$1,091	19657	\$1,373
	R/LHR	86ED	C	WH	HONEYCOMB / CRS	19620	\$1,049	19672	\$1,091	19658	\$1,373
	L/RHR	86ED	C	WH	HONEYCOMB / CRS	19621	\$1,049	19673	\$1,091	19659	\$1,373
	R/LHR	RPD	C	WH	HONEYCOMB / CRS	19622	\$1,097	19670	\$1,139	19660	\$1,421
	L/RHR	RPD	C	WH	HONEYCOMB / CRS	19623	\$1,097	19671	\$1,139	19661	\$1,421
4'0"	R/LHR	161	C	WH	HONEYCOMB / CRS	19624	\$1,152	156	\$1,200	19662	\$1,478
	L/RHR	161	C	WH	HONEYCOMB / CRS	19625	\$1,152	157	\$1,200	19663	\$1,478
	R/LHR	86ED	C	WH	HONEYCOMB / CRS	19626	\$1,152	7630	\$1,200	19664	\$1,478
	L/RHR	86ED	C	WH	HONEYCOMB / CRS	19627	\$1,152	7631	\$1,200	19665	\$1,478
	R/LHR	RPD	C	WH	HONEYCOMB / CRS	19628	\$1,200	19680	\$1,248	19666	\$1,526
	L/RHR	RPD	C	WH	HONEYCOMB / CRS	19629	\$1,200	19681	\$1,248	19667	\$1,526

NOTES:

1. Stock uses Steelcraft hinge and lock locations.
2. CH (Continuous Hinge) undersizing is 5/16"
- * 3. 8'0" stock doors are not available with WH mylar labels. Fire labels may be added through Door Mods.

Prices subject to change without notice.

L16-SERIES FLUSH DOORS - BEVELED EDGES AND HANDED

Width	Description						Part #	Unit Door \$
7'0" HIGH								
3'0"	R/LHR	161	C	WH	POLYS / GALV	19335	\$1,221	
	L/RHR	161	C	WH	POLYS / GALV	19336	\$1,221	
3'0"	R/LHR	RPD	C	WH	POLYS / GALV	19668	\$1,269	
	L/RHR	RPD	C	WH	POLYS / GALV	19669	\$1,269	
3'6"	R/LHR	161	C	WH	POLYS / GALV	19689	\$1,420	
	L/RHR	161	C	WH	POLYS / GALV	19690	\$1,420	
3'6"	R/LHR	RPD	C	WH	POLYS / GALV	19691	\$1,468	
	L/RHR	RPD	C	WH	POLYS / GALV	19692	\$1,468	
4'0"	R/LHR	161	C	WH	POLYS / GALV	19693	\$1,517	
	L/RHR	161	C	WH	POLYS / GALV	19694	\$1,517	
4'0"	R/LHR	RPD	C	WH	POLYS / GALV	19695	\$1,565	
	L/RHR	RPD	C	WH	POLYS / GALV	19696	\$1,565	
8'0" HIGH								
3'0"	R/LHR	161	C		POLYS / GALV	19697	\$1,570	
	L/RHR	161	C		POLYS / GALV	19698	\$1,570	
3'0"	R/LHR	RPD	C		POLYS / GALV	19699	\$1,618	
	L/RHR	RPD	C		POLYS / GALV	19780	\$1,618	

NOTES:

1. Stock uses Steelcraft hinge and lock locations.
2. 8'0" stock doors are not available with WH mylar labels. Fire labels may be added through Door Mods.

SZ18-SERIES FLUSH DOORS - SQUARE EDGES AND NON-HANDED

Width	Description						Part #	Unit Door \$	20 PAK \$
6'8" HIGH									
3'0"	R/L	RPD	C - CLOSED TOP	WH	POLYS / GALV	SZ002	\$635	\$12,094	
	R/L	86ED	C - CLOSED TOP	WH	POLYS / GALV	SZ003	\$586	\$11,157	
	R/L	161	C - CLOSED TOP	WH	POLYS / GALV	SZ004	\$586	\$11,157	
	R/L	RPD	C	WH	HONEYCOMB / CRS	SZ006	\$572	\$10,899	
	R/L	86ED	C	WH	HONEYCOMB / CRS	SZ007	\$523	\$9,962	
	R/L	161	C	WH	HONEYCOMB / CRS	SZ008	\$523	\$9,962	
7'0" HIGH									
3'0"	R/L	61L	C - CLOSED TOP	WH	POLYS / GALV	SZ010	\$606	\$11,539	
	R/L	RPD	C - CLOSED TOP	WH	POLYS / GALV	SZ011	\$655	\$12,475	
	R/L	86ED	C - CLOSED TOP	WH	POLYS / GALV	SZ012	\$606	\$11,539	
	R/L	161	C - CLOSED TOP	WH	POLYS / GALV	SZ013	\$606	\$11,539	
	R/L	RPD	C	WH	HONEYCOMB / CRS	SZ015	\$592	\$11,267	
	R/L	86ED	C	WH	HONEYCOMB / CRS	SZ016	\$542	\$10,331	
	R/L	161	C	WH	HONEYCOMB / CRS	SZ017	\$542	\$10,331	

NOTES:

1. Stock uses Steelcraft hinge and lock locations.
2. Only the Poly/Galv doors, noted above, have a closed top as standard.

Prices subject to change without notice.

Prices subject to change without notice.

About Allegion

Allegion (NYSE: ALLE) is a global pioneer in seamless access. We keep people and their assets safe, wherever they are, bringing together simple solutions, convenient access and advanced technology.

For more, visit www.allegion.com

KRYPTONITE ■ LCN ■  ■ STEELCRAFT ■ VON DUPRIN