

# TENNESSEE



# EROSION & SEDIMENT CONTROL HANDBOOK

---

A Stormwater Planning and Design Manual  
for Construction Activities

---



Fourth Edition

AUGUST 2012

## *Acknowledgements*

This handbook has been prepared by the Division of Water Resources, (formerly the Division of Water Pollution Control), of the Tennessee Department of Environment and Conservation (TDEC). Many resources were consulted during the development of this handbook, and when possible, permission has been granted to reproduce the information. Any omission is unintentional, and should be brought to the attention of the Division.

We are very grateful to the following agencies and organizations for their direct and indirect contributions to the development of this handbook:

- TDEC Environmental Field Office staff
- Tennessee Division of Natural Heritage
- University of Tennessee, Tennessee Water Resources Research Center
- University of Tennessee, Department of Biosystems Engineering and Soil Science
- Civil and Environmental Consultants, Inc.
- North Carolina Department of Environment and Natural Resources
- Virginia Department of Conservation and Recreation
- Georgia Department of Natural Resources
- California Stormwater Quality Association

## *Preface*

Disturbed soil, if not managed properly, can be washed off-site during storms. Unless proper erosion prevention and sediment control Best Management Practices (BMP's) are used for construction activities, silt transport to a local waterbody is likely. Excessive silt causes adverse impacts due to biological alterations, reduced passage in rivers and streams, higher drinking water treatment costs for removing the sediment, and the alteration of water's physical/chemical properties, resulting in degradation of its quality. This degradation process is known as "siltation".

Silt is one of the most frequently cited pollutants in Tennessee waterways. The division has experimented with multiple ways to determine if a stream, river, or reservoir is impaired due to silt. The most satisfactory method has been biological surveys that include habitat assessments. For those streams where loss of biological integrity can be documented, the habitat assessment can determine if this loss is due to excessive silt deposits. As reported in the latest 305b Report ([http://www.tn.gov/environment/wpc/publications/pdf/2010\\_305b.pdf](http://www.tn.gov/environment/wpc/publications/pdf/2010_305b.pdf)), the division has determined that 21% of its assessed rivers and streams, almost 6,000 miles, are polluted due to siltation.

Soil loss from pastureland averages 1.5 tons/acre-year, cropland cultivation can lose 20 tons/acre-year, whereas construction activities can result in 150 to 200 tons/acre-year in the stormwater runoff. Therefore, even a minor uncontrolled construction activity can cause major impairment in the receiving waters. Erosion prevention and sediment control BMP's are the key parameter for successful water quality protection.

This Erosion Prevention and Sediment Control Handbook has been designed to provide standardized and comprehensive erosion prevention and sediment control BMP's for use throughout Tennessee. This handbook serves as the primary reference for the development and implementation of Stormwater Pollution Prevention Plans (SWPPP), as required per the Tennessee General NPDES Permit for Discharges Associated with Construction Activities (<http://www.tn.gov/environment/wpc/stormh2o/TNR100000.pdf>) and individual NPDES permits. These permits allow the use of innovative or alternative BMPs or other controls, whose performance can be shown to be equivalent or superior to BMPs identified in this manual.

This handbook has been developed in loose-leaf format with the intention of allowing periodic updates. The handbook is available by attending one of the Erosion Prevention and Sediment Control courses offered by the Department (<http://www.tnepsc.org/>), or by download from the Department's web page ([http://www.tn.gov/environment/wpc/sed\\_ero\\_controlhandbook/](http://www.tn.gov/environment/wpc/sed_ero_controlhandbook/)).

## *Disclaimer*

*The erosion prevention and sediment control measures presented in this manual represent those that are currently being recommended, however their effectiveness is dependent on proper selection, combination, installation and maintenance. No guarantee is implied by the Tennessee Department of Environment and Conservation either by inclusion in this manual or acceptance of a Stormwater Pollution Prevention Plan (SWPPP) containing these measures. The General Permit for the Discharge of Stormwater from a Construction Activity (CGP) requires that when one of these measures are specified in the SWPPP, it be installed as presented in this manual.*



## *Table of Contents*

<b>1. Introduction</b> .....	1
<b>2. Regulations</b>	
2.1. General NPDES Permit for discharges of stormwater associated with construction activities .....	3
2.1.1. Impaired and Exceptional TN Waters Streams .....	5
2.1.2. Total Maximum Daily Load .....	7
2.2. Other permits .....	7
2.3. TVA permits .....	10
2.4. Water quality standards related to construction .....	11
2.5. Local stormwater regulations .....	11
2.6. Stormwater multi-sector general NPDES Permit .....	12
2.7. Endangered Species Act .....	13
2.8. Other invasive species, Federal Executive Order 13112 .....	14
<b>3. Predicting soil loss</b>	
3.1. RUSLE2 model .....	15
3.2. Other models .....	22
<b>4. Overview of Management Practices</b>	
<i>This section goes through each management practice in a manner to help     the user understand when to use the practice (fact sheet style)</i> .....	24
<b>5. Preparing the SWPPP</b>	
5.1. Principles of a SWPPP .....	72
5.2. SWPPP Content .....	73
5.2.1. Field reconnaissance .....	74
5.2.2. Local requirements .....	76
5.2.3. Staged drawings .....	76
5.2.4. Construction schedule .....	77
5.2.5. Construction details .....	78
5.2.6. Other considerations .....	80
5.3. Managing the SWPPP .....	84
5.3.1. Multiple operators, new operators, termination of operators .....	84
5.3.2. Onsite records management .....	84
<b>6. Integrating post construction requirements during construction</b>	
6.1. Low Impact Development Principles .....	86
6.2. How to manage construction without impacting your post construction practices .....	86

## 7. Management Practices

### Site preparation

7.1. Identifying sensitive areas or critical areas .....	90
7.2. Construction sequencing .....	93
7.3. Topsoiling .....	95
7.4. Tree preservation .....	98
7.5. Surface roughening and tracking .....	102

### Stabilization Practices

7.6. Stabilization with straw mulch .....	104
7.7. Stabilization with other mulch materials .....	107
7.8. Temporary vegetation .....	109
7.9. Permanent vegetation .....	113
7.10. Sod .....	122
7.11. Rolled erosion control products .....	126
7.12. Hydro applications .....	129
7.13. Soil binders .....	131
7.14. Emergency stabilization with plastic .....	137
7.15. Soil Enhancement .....	139

### Pollution Prevention

7.16. Concrete washout .....	142
7.17. Vehicle maintenance .....	145
7.18. Chemical storage .....	147
7.19. Trash and debris management .....	149

### Runoff Control and Management

7.20. Check dam .....	152
7.21. Dewatering treatment practice .....	155
7.22. Diversion .....	159
7.23. Outlet protection .....	165
7.24. Slope Drain .....	173
7.25. Tubes and wattles .....	177
7.26. Level spreader .....	181
7.27. Channels (stable channel design) .....	184

### Sediment Control Practices

7.28. Construction Exit (CE) .....	205
7.29. Tire washing facility .....	209
7.30. Filter ring (FR) .....	212
7.31. Sediment basin (SB) .....	215
7.32. Sediment trap .....	241
7.33. Baffles .....	246
7.34. Silt fence .....	250

7.35. Inlet protection .....	258
• Excavated inlet .....	262
• Hardware cloth and gravel .....	263
• Block and gravel .....	264
• Sod inlet .....	265
• Rock pipe .....	266
7.36. Construction road stabilization .....	269
7.37. Tubes and wattles .....	273
7.38. Filter berm .....	276
7.39. Turbidity curtain .....	279
7.40. Flocculants .....	282
<b>Stream Protection Practices</b>	
7.41. Stream buffers .....	286
7.42. Stream diversion .....	289
7.43. Temporary stream crossing .....	299
7.44. Bioengineered streambank stabilization .....	303
<b>8. Problem Solving</b>	
8.1. Interim steps .....	308
8.2. Design related problems .....	308
8.3. Construction related problems .....	309
8.4. Sediment releases .....	309
8.5. Spills .....	309
8.6. Buffer disturbance .....	310
<b>9. Inspections</b>	
9.1. The role of the inspector .....	311
9.2. Performing the inspection .....	312
9.3. Documentation .....	314
<b>10. Appendices</b>	
Appendix A – General NPDES Permit	
Appendix B – SWPPP preparation checklist	
Appendix C – Example Storm Water Pollution Prevention Plan (SWPPP)	
Appendix D – Channel design example	
Appendix E – Sediment basin design example	
Appendix F – Standard Drawings	

## Introduction

Soil is formed when chemical, physical, and biological weathering processes break down underlying bedrock. It may take hundreds or thousands of years for one foot of soil to develop. Soils have properties like texture, structure, porosity, and chemistry that are determined by the parent bedrock material, but may also be influenced by the actions we take to alter the soil profile. Soil fertility, or the ability of soil to sustain life, is the product of a combination of those properties. The alteration or destruction of one or more of these properties may have serious adverse effect on the soil's ability to grow stabilizing vegetative cover.

Erosion is the detachment of a portion of the soil profile or soil surface. This can occur by either the impact of raindrops, or by the shear forces of water flowing across the soil surface. Soil particles can be transported a short distance (like the splash from a raindrop impact), or may be transported a longer distance (to the bottom of the slope, or into a water conveyance) before being deposited. The transport and deposition process is called sedimentation.

Erosion and sedimentation are natural processes. These processes occur daily, on all land, as the result of wind, water, ice, and gravity. However, the effect of natural erosion is usually only noticeable on a geologic time scale. The global average, natural geologic rate of soil erosion is about 0.2 tons per acre per year. This is approximately equal to the rate that soil is being created by the weathering of bedrock and parent material. Disturbance of the soil surface, including activities like construction, farming, or logging, greatly increases the amount of sediment loss from the site due to erosion. Soil loss from pastureland averages 1.5 tons per acre per year. Cultivated cropland can lose 20 tons per acre per year. Major land disturbances, such as mines or construction sites, can experience annual soil loss from 150 to 200 tons per acre. Erosion may occur unnoticed on exposed soil even though large amounts of soil are being lost. One millimeter of soil removed from an area of one acre weighs about five tons. Five tons of silty clay loam equates to about 4.5 cubic yards of soil. Lost soil is a lost resource of the property. Lost soil may carry off important nutrients needed for reestablishing effective, attractive vegetation after the site development is complete. If erosion is severe enough, soil might have to be brought in from other locations to regrade eroded areas, or to provide a suitably fertile growing medium for vegetation establishment.

Sediments that escape the site will eventually enter a stream or wetland. Solids suspended in the water column will interfere with the photosynthesis of plant life that form the base of the aquatic system food web. Sediments may carry other pollutants, in the form of metals, pesticides, or nutrients, into streams, or cause organic enrichment of streams, which also disrupts the food web. Suspended sediments increase the costs of drinking-water treatment for municipalities.

Sediment deposition changes the flow characteristics of a water body. These changes may result in physical hindrances to navigation or increased possibility of flooding. Deposits may actually cause further erosion within a water body if the deposit occurs at a critical spot. Sedimentation in wetlands can alter the hydrology or destroy hydric vegetation. Sedimentation that occurs in streams can cover up habitat that certain integral parts of the food web rely on. Certain types of soil particles actually bind to the gills of aquatic insects or fish. Sediment may also smother nesting sites for fish or amphibians, or cover mussel beds that filter significant quantities of pollutants from water that ultimately becomes our drinking water.

The average erosion from a designated area over a designated time may be computed by using the Revised Universal Soil Loss Equation (RUSLE). RUSLE is an erosion model developed by the U. S.

Department of Agriculture to help make good decisions in soil conservation planning. It is a set of mathematical equations used to determine what conservation practices might be applied to a landscape to reduce or limit the amount of erosion and sediment loss. The original application for RUSLE was agriculture, primarily cropland production. Subsequent revisions have widened the program's applicability to be useful to other land-disturbing activities like mining, forest management, and construction sites.

The four major factors that RUSLE uses to compute the amount of soil loss from a site are: climate, soil erodibility, topography, and land use. The important climatic variables are the amount of rainfall and the intensity of the rainfall. Soils differ in their inherent erodibility, which is based on the previously mentioned properties: texture, structure, porosity, and chemistry. Climate and soil information are obtained from regionally mapped or surveyed data. Climatic and soil variables are independent of the activities we undertake at a worksite, however, the length of time that a bare area is exposed to precipitation is considered within the climate factor of RUSLE and may considerably affect the soil loss from the worksite. In this way, phasing and sequencing the surface disturbing activities at a worksite reduces the total erosion and reduces the amount of sediment that must be controlled by other means.

Site topography, ground cover, and BMPs use are the most variable factors in determining erosion. These three factors are also what we have control over. Slope length, slope steepness, and slope shape are the important components of topography. Much of the work done at construction sites is to change the slope length, steepness, or shape to make the property better suited for development. Obviously, the original vegetation must be disturbed to accomplish this work, however, ground cover is the single most influential variable in determining soil loss. The soil loss from a site that has been graded bare and has no BMP's in use may be 100 times the soil loss from the same site with an average stand of grass present. BMP's can reduce the amount of sediment leaving the site, but no single practice is 100% effective.

There are two types of BMP's. One type, **erosion prevention practices** are ground covers that prevent any of the types of erosion from occurring. Ground covers include vegetation, riprap, mulch, and blankets that absorb the energy of a raindrop's impact and reduce the amount of sheet erosion. Diversions, check dams, slope drains, and storm drain protection, while they may also trap sediment, are primarily used to prevent rill and gully erosion from starting. Rill and gully erosion are more difficult and expensive to repair, and result in greater volumes of sediment to control.

The second type, **sediment control practices** attempt to prevent soil particles that are already being carried in stormwater from leaving the site and entering streams or rivers. Silt fence, sediment traps, sediment basins, check dams, and even vegetative cover are sediment control practices. Of course, all BMP's must be chosen carefully, located and installed correctly, and maintained well to be effective at keeping sediment on a site.

It is important to note that a particular BMP may be an erosion prevention practice, or a sediment control practice, or it may serve both purposes at the same time.

Using RUSLE as our model, we can see that a combination of erosion prevention, consisting of leaving original vegetation and reestablishing vegetative cover, as well as sediment controls, like silt fences and sediment basins can prevent sediment loss from a construction site.

## 2.0 REGULATIONS

### Introduction

Stormwater discharges from construction sites often contain pollutants in quantities that can adversely affect water quality. Stormwater discharges are considered point sources and require coverage by a National Pollutant Discharge Elimination System (NPDES) permit. Authorized by the Clean Water Act, NPDES permits control water pollution by regulating point sources that discharge pollutants into waters of the United States. In Tennessee, the NPDES permit program is administered by the Tennessee Department of Environment and Conservation, Division of Water Pollution Control (TDEC-WPC).

This section provides an overview of the regulations governing erosion prevention and sediment control (EPSC), stormwater management, and related programs. Note that local jurisdictions can have stormwater and/or EPSC regulations. Note that each regulation must be met, with the more stringent requirement taking precedent.

### 2.1 GENERAL NPDES PERMIT FOR DISCHARGES OF STORMWATER ASSOCIATED WITH CONSTRUCTION ACTIVITIES

Tennessee is authorized by the Environmental Protection Agency under the Federal Water Pollution Control Act, as amended by the Clean Water Act of 1977 and Water Quality Act of 1987 and the Tennessee Water Quality Control Act of 1977 to implement the state's NPDES permit program. Construction stormwater is regulated under Tennessee's General NPDES Permit for Discharges of Stormwater Associated with Construction Activities (referred to as the CGP), Permit No. TNR100000.

#### Application.

This permit authorizes discharges from construction activities including clearing, grubbing, grading, filling and excavating (including borrow pits containing erodible material) or other similar construction activities that result in the disturbance of one acre or more of total land area.

Projects or developments of less than one acre of land disturbance are required to obtain authorization under this permit if the construction activities are part of a larger common plan of development or sale that is at least one acre in size. The CGP also authorizes stormwater discharges from support activities (concrete or asphalt batch plants, equipment staging yards, material storage areas, excavated material disposal areas, borrow areas) if the support activity is primarily related to a construction site that is covered under this general permit.

The CGP contains the *requirements* for managing construction related stormwater discharges. This manual contains the *required BMPs or equivalent* to meet the requirements of the CGP. Together, they form the foundation of Tennessee's EPSC program.

#### Obtaining coverage under the CGP

To obtain coverage under the CGP, operators of regulated construction sites are required to submit a complete stormwater pollution prevention plan (SWPPP), a Notice of Intent (NOI) and required permit fees. An NOI form is provided in the CGP document. If possible, the owner/developer and all contractors should apply for permit coverage on the same NOI form, but the TDEC-WPC may accept separate NOI forms from different operators for the same construction site when warranted.

Once the Notice of Coverage (NOC) has been issued for the site, construction activities can begin. The NOC is a written notice from the TDEC-WPC sent to the permittee, informing the permittee that the NOI was received and stormwater discharges from the construction activity have been authorized under this general permit; it is not an approval of the SWPPP. The operator is then authorized to discharge stormwater associated with construction activity, according to the SWPPP and the terms and conditions of the CGP, as of the effective date of the NOC. Operators wishing to terminate coverage under a permit must submit a completed Notice of Termination (NOT) in accordance with requirements of the CGP using the NOT form.

### **What is not covered by the CGP**

Except for discharges from support activities and certain non-stormwater discharges, all discharges covered by the CGP shall be composed entirely of stormwater. The following discharges are *not* authorized by this permit:

- Post-Construction Discharges – Stormwater discharges associated with construction activity that originate from the construction site after construction activities have been completed, the site has undergone final stabilization, and the coverage under this permit has been terminated.
- Discharges Mixed with Non-Stormwater – Discharges that are mixed with sources of non-stormwater.
- Discharges Covered by Another Permit – Stormwater discharges associated with construction activity that have been issued an individual permit.
- Discharges Threatening Water Quality – Stormwater discharges from construction sites that the director determines will cause, have the reasonable potential to cause, or contribute to violations of water quality standards.
- Discharges into Impaired Streams – The CGP does not authorize discharges that would add loadings of a pollutant that is identified as causing or contributing to the impairment of a water body on the list of impaired waters.
- Discharges into Outstanding National Resource Waters – The director shall not grant coverage under this permit for discharges into waters that are designated by the Water Quality Control Board as Outstanding National Resource Waters.
- Discharges into Exceptional TN Waters – The director shall not grant coverage under this permit for potential discharges of pollutants which would cause degradation to waters designated by TDEC as high quality waters.
- Discharges Not Protective of Federal or State listed Threatened and Endangered Species, Species Deemed in Need of Management or Special Concern Species – Stormwater discharges and stormwater discharge-related activities that are not protective of legally protected listed or proposed threatened or endangered aquatic fauna (or species proposed for such protection) in the receiving stream(s); or discharges or activities that would result in a “take” of a state or federal listed endangered or threatened aquatic or wildlife species, or such species’ habitat.
- Discharges from a New or Proposed Mining Operation – Discharges from a new or proposed mining operation are not covered by this permit.

- Discharges Negatively Affecting a Property on the National Historic Register – Stormwater discharges that would negatively affect a property that is listed or is eligible for listing in the National Historic Register maintained by the Secretary of Interior.
- Discharging into Receiving Waters With an Approved Total Maximum Daily Load (TMDL) Analysis – Discharges of pollutants of concern to waters for which there is an EPA-approved total maximum daily load (TMDL) are not covered by this permit unless measures or controls that are consistent with the assumptions and requirements of such TMDL are incorporated into the SWPPP.

### 2.1.1 Impaired and Exceptional TN Waters Streams

As required by Section 303(d) of the Clean Water Act, the state identifies streams and lakes that are not meeting their designated uses. This list is commonly called the impaired streams list or 303(d) list. The water bodies in the 303(d) list have been determined by TDEC-WPC, based on water quality assessment, to have one or more properties that violate water quality standards and are not fully meeting their designated uses or are expected to exceed water quality standards in the next two years and need additional pollution controls. Therefore, a higher degree of protection is necessary for these streams to prevent additional pollutant loading. The Construction General Permit supports this concept by requiring a higher degree of protection for streams impaired due to sediment and Exceptional Tennessee Waters (ETW). These streams have more stringent design criteria.

Similarly, TDEC reviews streams to determine if they meet the criteria for an exceptional TN waters designation. ETWs also include a category of streams classified as Outstanding National Resource Waters (ONRW). These stream classifications are described below.

**ONRW.** ONRWs are exceptional TN waters which constitute an outstanding national resource, such as waters of national and state parks and wildlife refuges and waters of exceptional recreational or ecological significance. In surface waters designated as ONRWs, no new discharges, expansions of existing discharges, or mixing zones will be permitted unless such activity will not result in measurable degradation of the water quality. Existing water quality is the criteria in these waters. Physical alterations that cause degradation to the ONRW are not allowed.

**ETW.** ETWs are waters that are within state or national parks, wildlife refuges, forests, wilderness areas, or natural areas; State Scenic Rivers or Federal Wild and Scenic Rivers; waters federally designated as critical habitat or other waters with documented non-experimental populations of state or federally-listed threatened or endangered aquatic or semi-aquatic plants, or aquatic animals; waters within areas designated as Lands Unsuitable for Mining because of impacts to water resource values; naturally reproducing trout streams; exceptional biological diversity; or other waters with outstanding ecological, or recreational values. In ETWs no degradation will be allowed unless it is demonstrated to the TDEC-WPC that a change is justified as a result of necessary economic or social development and will not interfere with or become injurious to any classified uses existing in such waters.

A list of impaired streams, ONRWs and ETWs is maintained on TDEC Water Pollution Control's website:

<http://tennessee.gov/environment/wpc/publications/hqwlist.mht>



A listing of impaired streams can be found here, under the Water Quality Assessment Publications:

<http://tennessee.gov/environment/wpc/publications/>

The CGP has specific requirements for impaired and exceptional TN waters streams. To be eligible to obtain and maintain coverage under the CGP, an operator must satisfy these additional requirements for discharges into waters impaired by siltation or high quality waters.

- The SWPPP must certify that EPSCs used at the site protect the resource at a higher level. When clay and other fine particle soils are found on sites, additional physical or chemical treatment of stormwater runoff may be required.
- The permittee shall perform required inspections as specified in the approved construction general permit.
- In the event the TDEC-Water Pollution Control (WPC) finds that a discharger is complying with the SWPPP, but contributing to the impairment of a receiving stream, then the discharger will be notified by the TDEC-WPC in writing that the discharge is no longer eligible for coverage under the general permit. The permittee may be required to update their SWPPP and implement changes designed to eliminate further impairment of the receiving stream if TDEC-WPC finds that the site is contributing to impairment of receiving stream. An individual permit may be required for the site if SWPPP changes are not implemented per CGP requirements. The project must be stabilized until such time as the SWPPP is re-developed and the individual permit is issued. No earth disturbing activities, except those necessary for stabilization, are authorized to continue until the individual permit is issued.
- For an outfall in a drainage area of a total of 5 or more acres, a temporary (or permanent) sediment basin that provides storage for a calculated volume of runoff from a 5 year, 24 hour storm and runoff from each acre drained, or equivalent control measures, shall be provided until final stabilization of the site. A drainage area of 5 or more acres includes both disturbed and undisturbed portions of the site or areas adjacent to the site, all draining through the common outfall. Where an equivalent control measure is substituted for a sediment retention basin, the equivalency must be justified. Runoff from any undisturbed acreage should be diverted around the disturbed area and the sediment basin and, if so, can be omitted from the volume calculation. Sediment storage expected from the disturbed areas must be included and a marker installed signifying a cleanout need.
- For sites that contain and/or are adjacent to a receiving stream designated as impaired or Exceptional Tennessee waters a 60-foot natural riparian buffer zone adjacent to the receiving stream shall be preserved, to the maximum extent practicable, during construction activities at the site. The natural buffer zone should be established between the top of stream bank and the disturbed construction area. The 60-foot criterion for the width of the buffer zone can be established on an average width basis at a project, as long as the minimum width of the buffer zone is more than 30 feet at any measured location.

A 30-foot natural riparian buffer zone adjacent to all streams at the construction site shall be preserved, to the maximum extent practicable, during construction activities at the site. The riparian buffer zone should be preserved between the top of stream bank and the disturbed construction area. The 30-foot criterion for the width of the buffer zone can be established on an average width basis at a project, as long as the minimum width of the buffer zone is more than 15 feet at any measured location.

### 2.1.2 Total Maximum Daily Load

Additionally, TDEC-WPC develops Total Maximum Daily Loads (TMDLs) for 303(d)listed waters. A TMDL is a study that quantifies the amount of a pollutant in a designated segment of a water body, identifies the sources of the pollutant, and recommends regulatory or other actions that may need to be taken in order for the stream to no longer be polluted. A TMDL also allocates pollutant loadings among point and nonpoint pollutant sources, including stormwater runoff. For a project discharging into a TMDL-listed segment of a stream, coverage under the CGP can be obtained only if the SWPPP addresses the following additional items:

Documentation supporting a determination of permit eligibility with regard to waters that have an approved TMDL for a pollutant of concern, including:

- a) identification of whether the discharge is identified, either specifically or generally, in an approved TMDL and any associated allocations, requirements, and assumptions identified for the discharge;
- b) summaries of consultation with the division on consistency of SWPPP conditions with the approved TMDL, and
- c) measures taken to ensure that the discharge of pollutants from the site is consistent with the assumptions and requirements of the approved TMDL, including any specific wasteload allocation that has been established that would apply to the discharge.

For more information on TMDLs, see TDEC WPC's website:

<http://tennessee.gov/environment/wpc/tmdl/>

## 2.2 OTHER PERMITS

A construction project may need additional types of permits, depending on the resources within the project boundaries and the potential impacts to those resources. This section briefly describes some of these permits. If these permits will be needed on a construction project, more detailed information will be necessary from the permitting agency. A website address for more information has been provided in each section.

### Underground Injection Wells

Anyone discharging stormwater to an improved sinkhole is required to submit an underground injection control (UIC) application to the Tennessee Division of Water Supply (DWS), Ground Water Management Section for coverage as a Class V injection well. More information on injection well permits and groundwater protection can be found here:

<http://tennessee.gov/environment/gwp/>

### ARAP/COE

Any activity that results in physical alterations to Waters of the State (which includes streams, rivers, lakes and wetlands) requires an Aquatic Resource Alteration Permit (ARAP) or §401 Water Quality Certification. The ARAP affirms that the discharge would not violate Tennessee's

water quality standards. These permitted activities fall into two categories: those that can be authorized under other general permits or those that require an application for an individual ARAP. Many, if not most, of the activities requiring an ARAP also require coverage under the CGP. If a U.S. Army Corps of Engineers (COE) Section 404 permit is required, TDEC-WPC processes the application as a 401 Certification. The majority of alterations that require an ARAP will also require a COE Section 404 and possibly a Section 10 permit from the COE for projects that include the discharge of dredged or fill material into waters of the U. S. including wetlands. The COE should be contacted directly for a definitive answer. When a 404 is required from the COE, a 401 certification must first be obtained from the TDEC-WPC.

General ARAPs provide a streamlined means for the TDEC-WPC to approve activities that are considered to result in minor impacts. Some General ARAPs require prior TDEC notification and/or approval before beginning the activity. Others only require that the activity be conducted in accordance with the conditions of the General ARAP. The following table summarizes the types of General ARAPs and when prior notification and/or approval is required. This table does NOT include the exclusions for each General ARAP, which must be met to obtain coverage.

More information on each permit type can be found at TDEC's ARAP website:

[www.state.tn.us/environment/permits/arapgps.shtml](http://www.state.tn.us/environment/permits/arapgps.shtml)

**Table 2-1. General ARAP Types**

General Permit Name	Notice to TDEC required?	Prior Approval Required?	Notes
Alteration of Wet Weather Conveyances	No		
Bank Stabilization	No	No	<50ft of bank length and <10yd <sup>3</sup> soil, sand, gravel deposited; allowed once
	Yes	Yes	>50ft of bank length and >10yd <sup>3</sup> soil, sand, gravel deposited
Construction and Removal of Minor Road Crossings	Yes	No	<25' length of stream channel disturbed, cumulative
	Yes	Yes	>25' length of stream channel disturbed
Construction of Launching Ramps and Public Access Structures	No	No	If located on TVA or COE managed easements
	Yes	Yes	All other areas
Construction of Intake and Outfall Structures	Yes	Yes	Doesn't authorize intake or discharge of waters

Emergency Road Repair	No	No	Must notify TDEC by phone and follow-up within 10 days of repair in writing to TDEC
Maintenance Activities	No	No	Removal of sediments and bedload 100' upstream and downstream of culvert inlet and outlet
	Yes	Yes	All other activities
Minor Alterations to Wetlands	Yes	Yes	Up to 0.25 acre of isolated wetlands or 0.1 acre non-isolated wetland impact, cumulative
Minor Dredging and Filling	No	No	TVA or COE managed reservoirs
	Yes	Yes	All other reservoirs or impoundments
Sand and Gravel Dredging	No	No	Collected from and used on a private residence of farm; where trees growing on sand bar are less than 2" in diameter
	Yes	Yes	All other areas
Sediment Removal for Stream Remediation	Yes	Yes	Sediment deposited from construction sites; two step submittal process
Stream Restoration and Habitat Enhancement	Yes	Yes	
Surveying and Geotechnical Exploration	No	No	
Utility Line Crossings	Yes	Yes	More than one crossing of the same stream by gravity sewer lines requires an individual ARAP
Wetlands Restoration and Enhancement	Yes	Yes	

## SAFE DAMS

The Division of Water Supply's Safe Dam Program is responsible for conducting certifications, inspections and approval of dams and reservoir projects. This program is designed to assure public safety from dangers of failures.

Dams are regulated under the Safe Dam Program if the structure can impound at least 30 acre-feet of water or is least 20 feet high. An acre-foot is an acre of water one foot deep, a 1/2 acre two feet deep, etc., or 43,560 ft<sup>3</sup>. Height is the difference between the elevation of the downstream toe and the elevation of the low point of the dam crest.

The following structures are exempt:

- Any dam owned or operated by the federal government, such as TVA and the Corps of Engineers.
- Any dam licensed by the Federal Energy Regulatory Commission (FERC).

- 1. “Diversion weirs”, “roadbeds”, “water tanks”, and “wastewater impoundment barriers” as defined in the Act.
- 2. “Farm Pond”: any dam that is used for conservation, recreation, or agriculture only by the owner and which is closed to the general public. “Farm Pond” status is based on use of the lake. Farm Ponds can be any size or hazard category.

All non-federal dams are required to have a certificate of approval from the Commissioner to construct, alter, or operate an impoundment. Non-federal dams may also require other environmental permits. Specifically, non-federal dams may require an ARAP (Aquatic Resource Alteration Permit), Storm Water Runoff Permit, and/or a Corps of Engineers' 404 Permit even though the dam may not be subject to the Safe Dams Act.

Safe Dam Program responsibilities include:

- Inspect Dams to assure ability to withstand storm events and evaluate stability
- Issue or deny certificates for construction, alteration, or operation of dams
- Assess civil penalties for violations of the Act or of the regulations and to institute court proceedings as necessary to enforce the Act or the regulations.
- Hear appeals from orders issued, certificates denied or suspended, etc.
- Request that the governor declare a state of emergency, if necessary and take whatever actions needed to render a dam safe.

### **2.3 TVA PERMITS**

The Tennessee Valley Authority (TVA) is a federal agency serving several purposes: to improve the navigability and to provide for the flood control of the Tennessee River; to provide for reforestation and the proper use of marginal lands in the Tennessee Valley; and to provide for the agricultural and industrial development of the valley. The TVA Act Section 26A requires that TVA approval be obtained before any construction activities can be carried out that affect navigation, flood control, or public lands along the shoreline of the TVA reservoirs or in the Tennessee River or its tributaries. TVA 26A is designed to ensure that construction along the shoreline does not have a negative effect on the agency's management of the river system. These regulations apply to the entire Tennessee River watershed which is divided into 12 sections, each overseen by a TVA Watershed Team that issues the 26A permits for shoreline construction activities in its area. Permit approvals for construction under Section 26A are considered federal actions and are therefore subject to the National Environmental Policy Act and other federal laws. Typical structures and projects that require TVA Section 26A approval include boat docks, piers, boat ramps, bridges, culverts, commercial marinas, barge terminals and mooring cells, water intake and sewage outfalls, and fill or construction within the floodplain.

For more information on TVA 26A permits, see their website:

[www.tva.gov/river/26apermits/](http://www.tva.gov/river/26apermits/)

## 2.4 WATER QUALITY STANDARDS RELATED TO CONSTRUCTION

Tennessee's water quality is regulated through the following regulations:

- Water Quality Control Act, T.C.A., §69-3-101, et seq., and
- *Rules of Tennessee Department of Environment and Conservation Division of Water Pollution Control*, Chapter 1200-4-3, General Water Quality Criteria and Chapter 1200-4-4, Use Classifications for Surface Water.

These regulations outline designated uses for streams as well as discharge quality from many different types of discharges.

The CGP contains specific discharge quality criteria for those activities covered by the CGP, as follows:

- a) The construction activity shall be carried out in such a manner that will prevent violations of water quality criteria as stated in the TDEC Rules, Chapter 1200-4-3-.03. This includes, but is not limited to, the prevention of any discharge that causes a condition in which visible solids, bottom deposits, or turbidity impairs the usefulness of waters of the state for any of the uses designated for that water body by TDEC Rules, Chapter 1200-4-4.
- b) There shall be no distinctly visible floating scum, oil or other matter contained in the stormwater discharge.
- c) The stormwater discharge must not cause an objectionable color contrast in the receiving stream.
- d) The stormwater discharge must result in no materials in concentrations sufficient to be hazardous or otherwise detrimental to humans, livestock, wildlife, plant life, or fish and aquatic life in the receiving stream.

## 2.5 LOCAL STORMWATER PROGRAMS

In the early 1990's and then again in 2003, EPA finalized regulations requiring local cities and counties that met specific criteria to develop their own stormwater management programs. In Tennessee, TDEC is the agency with regulatory oversight over these jurisdiction's programs. Approximately 85-90 local jurisdictions in TN are required by TDEC to have their own stormwater programs. These programs are required to meet minimum control measures established by TDEC through the NPDES permitting program. Substantial overlap exists with the municipal NPDES stormwater permit and the CGP, in that the municipal permit requires the covered MS4s to develop construction site runoff control programs. Each covered jurisdiction is required to develop the following, as a minimum:

- Construction site runoff control programs that are at least as restrictive as the CGP requirements. Most jurisdictions require the submittal of a SWPPP prior to issuing development plans or a building permit.
- Permanent water quality buffer program for streams. While the CGP requires a water quality buffer along all streams within a construction project, once the CGP Notice of Termination has been issued, the buffer restriction is no longer in place. However, the buffer program established by each regulated jurisdiction requires perpetual water quality buffers. Each jurisdiction has the flexibility to develop water quality buffers that are protective of the natural resources in their jurisdictions, including establishing a minimum buffer width.
- Permanent stormwater quality management controls. The CGP is a temporary permit so once construction activity has been completed and the site has been stabilized, the permit can be terminated. However, runoff from built-upon land can carry stormwater pollutants to streams, ponds and wetlands. Through the NPDES municipal stormwater permit, regulated jurisdictions must develop permanent stormwater quality management programs addressing pollutants from built upon surfaces after construction is complete. These measures must be integrated into the overall development plan and considered during construction. Each jurisdiction has the flexibility to develop their stormwater quality management program based upon their unique geology, hydrology, and pollutants of concern.

When developing a site plan or planning for construction activities, check with your local jurisdiction early in the planning process to understand their unique requirements and how those requirements may affect your SWPPP. Both local requirements *and* state requirements related to construction sites must be met.

## 2.6 STORMWATER MULTI-SECTOR GENERAL NPDES PERMIT

All new and existing point source *industrial* stormwater discharges associated with industrial activity require coverage under TN's Stormwater Multi-Sector NPDES Permit (TMSP) issued by TDEC. The most common industrial stormwater permit is the general permit which is available to almost any industry, but there is also an option to obtain an individual NPDES permit. Construction activities that mix construction stormwater with industrial stormwater may need coverage under the TMSP. The TMSP states the permit "may authorize stormwater discharges associated with industrial activity that are mixed with stormwater discharges associated with industrial activity from construction activities provided that the stormwater discharge from the construction activity is authorized by and in compliance with the terms of a different NPDES general permit or individual permit authorizing such discharges." Requirements of the TMSP are separated by standard industrial classification, or SIC code. For more information about industrial activities and the TMSP, see TDEC-WPC's website:

[www.state.tn.us/environment/permits/tmsp.shtml](http://www.state.tn.us/environment/permits/tmsp.shtml)



## 2.7 ENDANGERED SPECIES ACT

Through federal action and by encouraging the establishment of state programs, the 1973 Endangered Species Act provides for the conservation of ecosystems upon which threatened and endangered species of fish, wildlife, and plants depend.

The Endangered Species Act:

- authorizes the determination and listing of species as endangered and threatened;
- prohibits unauthorized taking, possession, sale, and transport of endangered species;
- provides authority to acquire land for the conservation of listed species, using land and water conservation funds;
- authorizes establishment of cooperative agreements and grants-in-aid to States that establish and maintain active and adequate programs for endangered and threatened wildlife and plants;
- authorizes the assessment of civil and criminal penalties for violating the Act or regulations; and
- authorizes the payment of rewards to anyone furnishing information leading to arrest and conviction for any violation of the Act or any regulation issued.

A developer or his engineer must determine prior to submitting a NOI for coverage under the CGP whether listed species are located on or near the project area by contacting the local offices of the U.S. Fish and Wildlife Service (FWS), TDEC Natural Heritage Inventory Program and Tennessee Wildlife Resources Agency (TWRA). These agencies handle the legal listings of protected species in Tennessee. The TDEC Natural Heritage Inventory Program publishes a list of the rare animals of Tennessee, which can be queried online by county or watershed. If you are aware that state-listed species are located within or adjacent to your project, it is strongly suggested that the Natural Heritage Inventory Program and FWS be informally consulted.

If the TDEC-WPC or the TDEC Natural Heritage Inventory Program find that stormwater discharges or stormwater related activities are likely to result in discharges not protective of or results in a “take” of listed species or such species’ habitat, the division will deny the coverage under the CGP until project plans are changed to adequately protect the species in receiving stream(s). The TDEC-WPC may require revisions to the SWPPP necessary to prevent a negative impact to legally protected state or federally listed aquatic fauna, their habitat, or the receiving waters. For more information on the Natural Heritage Inventory Program, see their website:

[www.state.tn.us/environment/na/nhp.shtml](http://www.state.tn.us/environment/na/nhp.shtml)

### U.S. Fish & Wildlife

The FWS is the government agency dedicated to the conservation, protection, and enhancement of fish, wildlife and plants, and their habitats. FWS is responsible for implementing and enforcing of the Endangered Species Act, Migratory Bird Treaty Act, and Marine Mammal Protection and maintains the list of federally listed endangered or threatened species. If there are listed species



in the project county, the list of critical habitat needs to be examined to determine if that area overlaps or is near the project area. Critical habitat areas may be designated independently from the listed species for the county, so even if there are no listed species in the project area county, FWS should be contacted to determine if there are any critical habitat areas on or near the project area. For more information, see the US Fish and Wildlife Service website here:

[www.fws.gov/](http://www.fws.gov/)

## **2.8 OTHER INVASIVE SPECIES, FEDERAL EXECUTIVE ORDER 13112**

On Feb 3, 1999, a federal Executive Order was signed by the President establishing the National Invasive Species Council. The Executive Order requires that a Council of Departments dealing with invasive species be created to prevent the introduction of invasive species; provide for their control; and minimize the economic, ecological, and human health impacts that invasive species cause. This order defines invasive species, requires federal agencies to address invasive species concerns and to not authorize or carry out new actions that would cause or promote the introduction of invasive species, and established the National Invasive Species Council (NISC).

For more detailed information and a copy of the Executive Order, please visit USDA's Invasive Species website:

[www.invasivespeciesinfo.gov/laws/execorder.shtml](http://www.invasivespeciesinfo.gov/laws/execorder.shtml)

NISC ensures that Federal programs and activities to prevent and control invasive species are coordinated, effective and efficient. NISC provide invasive species control, management and restoration information on their website:

<http://www.invasivespecies.gov/>

## 3.0 PREDICTING SOIL LOSS

### Introduction

Construction project personnel may find it very helpful to estimate soil loss at specific site locations during various stages of construction. These soil loss estimates can help with EPSC measure planning and can help show which project stages have the largest predicted soil losses. There are many computer models that can be used to estimate soil losses on project sites. However, these computer models do not replace EPSC measure design procedures. It is also important to recognize that all computer models include assumed conditions and are not applicable to all situations. Knowing how to properly use the model and how to correctly interpret the model's results are critical for success.

One of the most well-known models for estimating long-term soil loss is the Universal Soil Loss Equation (USLE) and later revisions and updates to the original USLE method. One reason for the popularity of the USLE family of models is that there are few required inputs, and the inputs have remained user-friendly. This section will discuss using the Revised Universal Soil Loss Equation 2 (RUSLE2), which is a more recent update for the USLE model family. The References at the end of this section include other RUSLE2 references for more in-depth information about the model's development and use.

There are also other computer models that also allow users to estimate eroded sediment amounts for a target area (slope, watershed, etc.). However, many of the other models usually require using more model inputs for the model to run than the USLE family of models. Some of the other models incorporate some version of one of the USLE models. The section also provides a brief introduction for other computer models that may be used for estimating construction site soil loss. The References at the end of this section include further reference information about the models discussed in this section.

### 3.1 RUSLE2 MODEL

The RUSLE2 model and other related support materials are available through the United States Department of Agriculture's Agricultural Research Service (USDA-ARS) official RUSLE2 website here:

[http://fargo.nserl.purdue.edu/rusle2\\_dataweb/RUSLE2\\_Index.htm](http://fargo.nserl.purdue.edu/rusle2_dataweb/RUSLE2_Index.htm)

This section discusses the basics of the methodology behind and use of RUSLE2, and how RUSLE2 results relate to construction sites. It does not include detailed information about how to use the model's Windows interface or how to set up a RUSLE2 model run. The references at the end of the section provide supplemental information on how to set up and use RUSLE2.

The RUSLE2 model calculates long-term sediment loss on slopes from rill and interrill erosion. Rainfall and runoff actions cause soil particle removal during rill and interrill erosion. The interrill erosion process starts with raindrop impact detaching soil particles and allowing these particles to move across the soil surface. Detached soil particles will be referred to as sediment. Interrill

erosion may also be called sheet erosion. Interrill erosion runoff collects and forms rills on the hill slope. Sediment is then transported through the rills down the slope until the runoff flow slows down enough to allow the sediment to be deposited on either the land surface or in concentrated flow areas such as channels.

### **RUSLE2 Model Applicability**

The RUSLE2 model can be used to help with EPSC and construction planning for construction sites. Some scenarios where RUSLE2 can be used as a planning tool are listed below:

- Calculating a baseline estimated soil loss to use for comparison with other scenarios;
- Comparing slope erosion rates at different construction stages;
- Comparing effect of erosion control measures in reducing erosion (rank practices for evaluating performance, cost-benefit);
- Calculating estimated sediment yields for phased and timed projects to minimize soil exposure to erosive rain events;
- Diverting runoff away from potentially high-erosion areas;
- Reducing overland flow path length where erosion control practices do not provide desired control (e.g., shorten overland flow path length, reduce steepness and more favorable slope shape);
- Showing the effects of stabilizing disturbed areas with vegetation, mulch or gravel soon after soil exposure;
- Selecting local environment vegetation types for long-term erosion control and management practices;
- Adding flat segments at end of overland flow paths to allow for deposition; and
- Using sediment trapping devices.

All computer models involve assumed conditions and calculations that help in defining to which situations the model is (or is not) applicable. The RUSLE2 computer model can be used to calculate rill and interrill erosion for slopes with mineral soils. However, there are situations where RUSLE2 is not applicable. The model developers do not recommend using RUSLE2 results directly for EPSC measure design procedures, but RUSLE2 output may be used to evaluate relative effectiveness of different EPSC measures. RUSLE2 does NOT apply for the scenarios in the following list:

- Concentrated flow areas (e.g., gullies, ditches, streams);
- Undisturbed forestland;
- Erosion by piping;
- Erosion caused by snowmelt;
- Erosion by mechanical processes (mass movement such as landslides, movement by tillage operations);

- Organic soils;
- Slope lengths longer than 1000 feet (maximum slope length used for deriving RUSLE2 data was 650 feet);
- Slope steepness greater than 100% (data used to derive RUSLE2 included very little slope data for slopes above 30%);
- Sediment basins beyond small, very simple sediment basins; and
- Sediment basin and diversion engineering designs

### **RUSLE2 Model Equation**

To use RUSLE2, the user inputs climate, soil, slope, landuse and management information and the model output is the net average annual sediment loss. The equation format for RUSLE2 is the same as the equation format for most of the USLE family of models, and is shown in Equation 3.1. Each factor in the equation will be briefly introduced.

#### **Equation 3.1 RUSLE2 Equation.**

$$A = RKLSCP$$

A = average soil loss from rill and interrill erosion caused by rainfall and associated overland flow (tons/acre/time) – timeframe for loss calculations may be set by the user.

R = climate erodibility

K = soil erodibility for standard condition

L = slope length

S = slope steepness

C = cover management factor

P = support practices factor

#### **Average Soil Loss (A)**

The RUSLE2 model output (A) gives the average soil losses for the user-specified timeframe and is actually a net loss amount because the model allows for deposited sediment to be removed from the average soil loss. The RUSLE2 model involves some calculation differences from the calculations used in the USLE and RUSLE1. The USLE and RUSLE1 are used to calculate annual average soil losses, but cannot calculate average soil losses for shorter timeframes.. RUSLE2 includes daily soil loss calculations that allow the user to better refine soil loss estimates for a user-specified timeframe. The daily loss calculations are summed to get the loss for the user-specified timeframe as well as for annual loss estimates. Therefore, RUSLE2 model output for A may be based on a shorter timeframe (i.e., per day, week or month) as well as on an annual basis. More information about how RUSLE2 calculations are computed and how the RUSLE2 factors are calculated can be found in the reference materials.

The average loss can also be viewed as the net sum of soil losses related to the following four processes:

- soil loss on the eroding portion the slope;
- soil detachment on the entire slope;
- conservation planning soil loss; and
- sediment delivery for the slope length.

The soil loss on the eroding slope portion and the soil detachment on the entire slope describe the rill and interrill erosion processes. Conservation planning soil loss allows the user to include specific measures or practices that reduce slope erosion losses. Sediment delivery for the slope length gives a net amount of sediment that is not lost to sediment deposition along the slope.

Another way to view the model calculation process .can be summarized with Equation 3.2. The net annual soil loss may also be referred to as the sediment yield.

### **Equation 3.2. Net soil loss relationship equation**

$$\text{Net Soil Loss} = \text{Soil Loss} - \text{Deposition}$$

### **Climate Erodibility (R)**

The climate erodibility factor (R-value) is also known as an erosivity index and accounts for rainfall amount and intensity for the specified location. Temperature is also included in this factor since temperature can indirectly affect erosion by affecting decomposition rates for vegetation and other organic materials used for erosion control. This R value is allowed to vary by month to account for seasonal variations. However, RUSLE2 is not equipped to account for other seasonal vegetation growth and variations. Climate data for the R-value may be obtained from the national RUSLE2 databases and supplemented as needed based on local conditions.

The R factors for RUSLE2 for an area are typically developed on an average annual basis similar to the methods used for USLE. For the daily calculations performed by RUSLE2, the average annual R factor is multiplied by the fraction that occurs on a given day. This fraction is based on seasonal variations in temperature and rainfall.

### **Soil Erodibility (K)**

The soil erodibility factor (K-value) is set based on how susceptible the soil is to erosion. The K factor are determined empirically based on specific slope conditions known as a RUSLE2 unit plot. The unit plot method allows the K factor to be set using consistent conditions for various soil types and conditions. The unit plot is 72.6 feet long, 9% steep, maintained in a continuous fallow (no vegetation) and has a seedbed that is tilled up and down slope. Using the unit plot method as a common basis for testing soils produces K-factors that are independent of other variables such as ground cover, management practices, etc. that also affect erosion on slopes. These other variables are accounted for with other RUSLE2 variables.

The K-factor is based on a combination of soil and site properties. The soil texture is the most important soil information included in the K-factor. The soil texture is based on the distribution

(percentages) of clay, silt and sand particles in the soil. The soil's type is specified by the percentages of each of these soil particle types. K-factors can also be affected by seasonal changes (e.g., soil moisture content, freeze and thaw cycles) and local variations.

In general, soils with higher clay content have lower K-values because clay particles produce strong forces between soil particles that help the soil particles resist being detached by raindrop impact and by overland flow. Soils with high sand content also have lower K-values because sandy soils have higher infiltration rates that lead to reduced runoff and erosion. Soils with high percentages of silt particles are the soils most likely to be eroded because silt particles can be easily detached by raindrops and by runoff, and silty soils also produce more runoff for a given rainfall amount than sandy soils.

Most non-disturbed soils in the United States have a K-value assigned that can be located in the Natural Resources Conservation Service's (NRCS) national RUSLE2 database. For highly disturbed soils where the soil layers have been mixed, K-values are not predetermined. This highly disturbed condition can exist on construction sites, and should be considered when performing RUSLE2 calculations. RUSLE2 can help with estimating K-values for highly disturbed soils, but the user may have to collect and analyze soil samples to help with developing these input estimates. For determining the K-factor for highly disturbed soils, the RUSLE2 user's manual suggests first looking for a suitable soil within the NRCS database. The selected soil and the disturbed soil should match well for the following variables: erodibility factor K-value, soil texture for upper 4 to 6 inches of soil, hydrologic soil group and rock cover on the soil surface.

### **Slope Length (L) and Slope Steepness (S)**

The slope length (L-value) and slope steepness (S-value) factors are often referred to in combination since both help define the overland flow path and topography used in RUSLE2. Some models within the USLE family of models treat these as a combined "LS" factor rather than as two separate factors. The three main topographic factors in RUSLE2 that define the overland flow path are average steepness, overland flow path length and flow path profile (slope) shape. The slope length is defined as the distance from where overland flow begins to occur to where flow becomes concentrated or to where deposition begins. However, this definition can be too simplified for certain complex slopes. As slope steepness increases, erosion also increases. Erosion also increases for longer overland flow path lengths because more runoff accumulates over the longer length. The overland flow path length contributes more to erosion on steep slopes than on areas with flatter slopes. The profile or slope shape also affects erosion and net soil loss. RUSLE2 allows users to input the following four main types of slope shapes:

- Uniform;
- Convex;
- Concave; and
- Complex.

Figure 3.1 shows examples of the different types of slope shapes. Uniform slopes have consistent steepness, soil and cover management conditions throughout the whole slope with no variations. Concave slopes are slopes where the steepness increases along the slope, and can produce higher erosion rates at the end of these slopes. Convex slopes have decreased steepness along the slope, and can have sediment deposition areas at the end of the slope if the end of the slope is flat enough to slow down runoff and allow sediment to deposit. Complex slopes are used where conditions along a slope are variable. Complex slopes include slopes that involve a combination of concave and convex sections as well as slopes where soil and land use conditions vary along a slope. RUSLE2 allows the user to break a slope into multiple segments for complex slopes, and to specify properties for each slope segment.

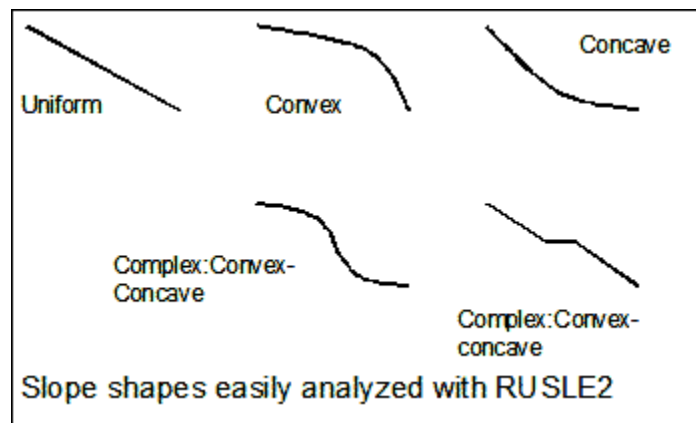

**Figure 3.1. The four main types of RUSLE2 slope shapes**

### **Cover Management Factor (C) and Support Practices (P)**

The cover management factor (C-value) includes land use conditions for the slope and the support practices factor (P-value) allows the user to specify what support practices may be in use on the slope. These two factors are inter-related, but are two different factors in RUSLE2.

The C-value depends on vegetation type and growth, application of surface and buried materials (e.g., mulch, manure), crop rotation, conservation tillage and random roughness. The C factor is split into subfactors in earlier USLE models. RUSLE2 includes subfactors for the following items:

- Canopy;
- Ground cover (e.g., vegetation, mulch, rock);
- Surface roughness;
- Ridges;
- Below ground biomass (e.g., roots);
- Soil consolidation; and
- Antecedent soil moisture.



These subfactors are independent of landuse and can interact with one another. For example, the user must avoid “double counting” the same vegetation areas toward both canopy and ground cover subfactors. RUSLE2 uses equations to determine how these subfactors interact and how the subfactors affect soil loss. Further information about subfactors and how these affect RUSLE2 calculations is available in the reference materials. The user’s manual notes that for temporary (1-year) disturbed condition runs, it is important to select “NO” for crop rotation – this prompts RUSLE2 to set initial conditions for cover-management. For disturbed land, initial condition is important because erosion depends on previous land use conditions. Users should also note that RUSLE2 does not adjust vegetation-related factors for local conditions.

Examples of P factor practices include contouring, strip systems (e.g., buffer strips, filter strips), terrace/diversions, small impoundments such as small sediment basins and tile drainage. More information about these practices and modeling the practices in RUSLE2 can be found in the reference materials. One RUSLE2 output that can be linked with the P factor practices is critical slope length.

Users should be careful when specifying cover management and supporting practice factor inputs. As mentioned earlier, avoid inadvertently “double counting” for the cover management subfactors. Practice installation is also sensitive to installation and location. Overland flow practices modeled in RUSLE2 such as silt fence and grass strips are assumed to be installed right on the contour. For installations that are not well aligned with the contour, sediment deposition decreases and concentrated flow occurs sooner (i.e., the practice’s effectiveness is reduced). The model developers do not recommend using grass strips for steep slopes since RUSLE2 will greatly reduce sediment yield for the slopes beyond what would be observed in an actual installation.

### **Model Output**

RUSLE2 provides multiple model outputs that can be used for gauging model performance and for planning different management scenarios. One output value is the average soil loss for the user-specified timeframe. Soil loss values can be compared for different management scenarios and different timeframes to determine if construction project EPSC measures and/or construction timing can help reduce estimated soil losses. RUSLE2 also gives a critical slope length output that gives the maximum slope length before the contouring management practice begins to fail. If the actual slope length is greater than the critical slope length, the slope may be more vulnerable to EPSC failures. Cover management systems that increase slope roughness and/or ground cover can be implemented to increase the critical slope length. Other measures such as grass strips or terraces may also be used to increase the critical slope length. It is desirable for the actual slope length to be less than the critical slope length for erosion control applications. Model users should carefully review RUSLE2 model input and output information to check that the model inputs and results are reasonable and consistent with accepted values from the model’s user’s manual.

### **Model Summary**

Table 3.1.1 gives a brief summary of some key properties, abilities and limitations for using RUSLE2. Users should consult the RUSLE2 user’s manual and other related references for more detailed information.



**Table 3.1-1 RUSLE2 Model Summary**

<b>Model Description</b>	<b>Model Information</b>
Model Area Scale	<ul style="list-style-type: none"> <li>• Slope-based or watershed-based</li> </ul>
Model Time Scale	<ul style="list-style-type: none"> <li>• Range covers daily to long-term (annual and multi-year)</li> </ul>
Key Equations Included	<ul style="list-style-type: none"> <li>• RUSLE2 equation</li> </ul>
Model Format	<ul style="list-style-type: none"> <li>• Computer-based (Windows program)</li> </ul>
GIS Compatibility	<ul style="list-style-type: none"> <li>• ArcMUSLE add-on tool</li> <li>• Model inputs such as drainage area, slopes, etc. can be calculated using GIS, typically using gridded data such as digital elevation models (DEMs)</li> </ul>
Key Assumptions/Limitations	<ul style="list-style-type: none"> <li>• User's understanding of how to perform Q and q<sub>P</sub> calculations will greatly affect model's results</li> <li>• Watershed-based and slope-based calculations will depend on the user's knowledge of condition of slopes (steepness, amount of cover, slope type, etc.)</li> </ul>
Pros	<ul style="list-style-type: none"> <li>• Ease of use (does not require computer analysis)</li> </ul>
Cons	<ul style="list-style-type: none"> <li>• Users need more knowledge than for RUSLE2 use (need to know how to calculate Q and q<sub>P</sub>)</li> <li>• Model contains empirical parts</li> </ul>

### 3.2 OTHER MODELS

Other computer models are also available that can be used to calculate soil loss for slopes and for larger areas. Brief overviews for several of these models are presented in this section.

#### MUSLE

The Modified Universal Soil Loss Equation (MUSLE) was developed as an alternative to the USLE that allowed the user to calculate sediment yield from rill and interrill erosion and to apply the model to single storm events. The MUSLE method was originally developed by Williams and Berndt, 1976. In MUSLE, the RUSLE2 rainfall energy factor (R) is replaced with a runoff factor (Q x q<sub>P</sub>). The MUSLE equation is presented below:

#### Equation 3.2-1 MUSLE

$$T = 95(V \times Q_p)^{0.56} \times K \times LS \times C \times P$$

Where:

- T = sediment yield per storm event in tons
- V = volume of runoff per storm event in acre-feet
- Q<sub>P</sub> = peak flow per storm event in cubic feet per second
- K, LS, C, and P are RUSLE factors

Values for V and Q<sub>P</sub> are determined from the sites drainage analysis.

The runoff volume (V) is calculated using the commonly used NRCS curve number method found in NRCS National Engineering Handbook Section 4: Hydrology (NEH-4). The peak discharge (Q<sub>P</sub>) can be calculated using the graphical peak discharge method that is described in the user's

manual for NRCS model Technical Release 55 (TR-55). The graphical peak discharge calculation requires the user to determine travel times for both sheet flow and shallow concentrated flow to calculate a time of concentration ( $T_c$ ).

**Table 3.2-1 MUSLE Model Summary**

Model Description	Model Information
Model Area Scale	<ul style="list-style-type: none"> <li>Watershed-based (<math>V</math> and <math>Q_P</math> calculations require watershed parameters)</li> </ul>
Model Time Scale	<ul style="list-style-type: none"> <li>Single storm events (<math>V</math> and <math>Q_P</math> calculations for single storm events)</li> </ul>
Key Equations Included	<ul style="list-style-type: none"> <li>MUSLE</li> <li>NRCS curve number method for <math>V</math> calculation</li> <li>NRCS graphical peak discharge method and travel time equations for <math>q_P</math> calculation</li> </ul>
Model Format	<ul style="list-style-type: none"> <li>Equation-based</li> <li>Does not require computer calculations, but use can be expanded to larger areas with computer calculations</li> </ul>
GIS Compatibility	<ul style="list-style-type: none"> <li>ArcMUSLE add-on tool</li> <li>Model inputs such as drainage area, slopes, etc. can be calculated using GIS, typically using gridded data such as digital elevation models (DEMs)</li> </ul>
Key Assumptions/Limitations	<ul style="list-style-type: none"> <li>User's understanding of how to perform <math>V</math> and <math>Q_P</math> calculations will greatly affect model's results</li> <li>Watershed-based and slope-based calculations will depend on the user's knowledge of condition of slopes (steepness, amount of cover, slope type, etc.)</li> </ul>
Pros	<ul style="list-style-type: none"> <li>Ease of use (does not require computer analysis)</li> </ul>
Cons	<ul style="list-style-type: none"> <li>Users need more knowledge than for RUSLE2 use (need to know how to calculate <math>V</math> and <math>Q_P</math>)</li> <li>Model contains empirical parts</li> </ul>

## REFERENCES

*Integration of Modified Universal Soil Loss Equation (MUSLE) into a GIS Framework to Assess Soil Erosion Risk.* Y. Zhang, J. Degroote, C. Wolter and R. Sugumaran. 2009. *Land Degradation and Development*. Volume 20, pp. 84-91.

*RUSLE2 User Manual for Highly Disturbed Lands: Construction, Reclaimed, Mined, Landfills, Military Training Grounds, and Similar Lands.* George R. Foster and Terry Toy. 2005. USDA – Agricultural Research Service.

*Soil-Loss Estimation for Construction Lands Using RUSLE 2.0.* Terrence Toy, Ph.D., CPESC and George Foster. Ph.D. February 2007. IECA Training Course.











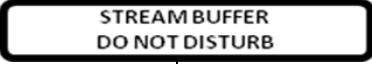

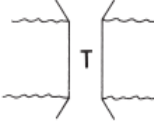

## 4.0 OVERVIEW OF MANAGEMENT PRACTICES











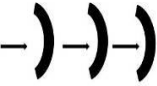

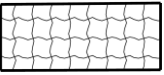
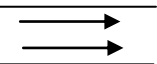

This section covers each management practice in a manner to help the user understand when each practice can or should be used. It should be the first step towards determining which practices should be incorporated into the Stormwater Pollution Prevention Plan (SWPPP). This section does not contain design information and guidance. Section 7 of this manual should be consulted for that information.

### 4.1 SYMBOLS

The following table contains standard symbols for structural management practices. Note that Site Preparation management practices (Practices 7.1 through 7.5) are a component of the initial site planning and overall site management and therefore do not have specific symbols. Management practices are grouped by management practice category: Site Preparation, Stabilization, Pollution Prevention, Runoff Control and Management, Sediment Control, and Stream Protection Practices.

**Table 4.1 Management Practices Symbols**

<b>STREAM PROTECTION PRACTICES</b>		<b>POLLUTION PREVENTION PRACTICES</b>	
	7.41 Stream Buffers		7.16 Concrete washout
	Stream Diversion Channel		7.17 Vehicle maintenance
	7.43 Temporary Stream Crossing		7.18 Chemical storage
	7.44 Bioengineered Stream Bank Stabilization		7.19 Trash and debris
<b>RUNOFF CONTROL PRACTICES</b>		<b>STABILIZATION PRACTICES</b>	
	7.20 Check Dam		7.6 Disturbed Area Stabilization with straw mulch
	7.21 Dewatering Treatment Practice		7.7 Disturbed area stabilization with other mulches
	7.23 Outlet Protection		7.8 Disturbed Area Stabilization with Permanent Vegetation

	7.24 Slope Drain	<b>SO</b>	7.9 Disturbed Area Stabilization with Sod
	7.25 Tubes and Wattles	<b>TS</b>	7.10 Disturbed Area Stabilization with Temporary Vegetation
	7.26 Level Spreader		7.11 Rolled Erosion Control Products
	7.27 Channels	<b>HYD</b>	7.12 Hydro Applications
<b>SEDIMENT CONTROL PRACTICES</b>			7.13 Soil binders and tackifiers
	7.28 Construction Exit	<b>PLAS</b>	7.14 Emergency stabilization with plastic
	7.29 Tire washing facility	<b>SE</b>	7.15 Soil Enhancement
	7.30 Filter Ring	<b>SEDIMENT CONTROL PRACTICES</b>	
	7.31 Sediment Basin	<b>CRS</b>	7.36 Construction Road Stabilization
	7.32 Sediment Trap		7.37 Tubes and Wattles (Sediment Control)
	7.33 Baffles	---F Berm ---F Berm ---F Berm ---	
	7.34 Silt Fence		7.38 Filter berm
	7.35 Inlet Protection		7.39 Turbidity curtain
			7.40 Flocculants

**PRACTICE 7.1: IDENTIFYING SENSITIVE OR CRITICAL AREAS**

*See Chapter 7, Page 90*

*Orange safety fencing was used as a visual marker to keep construction activity out of a stream buffer.*

*Purpose and Application.* Identifying sensitive areas on a development site in preparation for construction has many benefits, including lowering the cost of the development. Protecting these areas is much more cost effective than replacing or repairing them after they have been impacted by construction.

*Description.* Before construction begins on the project, locate and visually mark sensitive areas such as streams and Aquatic Resources Alteration Permit boundaries, buffers, wetlands, sinkholes, caves, critical habitat, and historical areas. Markers can include brightly colored flagging or barrier fencing but should be different from other construction marking and flagging. Areas that pose certain neighborhood danger should also be marked such as sediment ponds.

*Limitations* Local requirements for tree protection may be more stringent than orange construction fencing such as requiring chain link fence.

*Maintenance.* Whatever method is chosen to identify sensitive or critical areas must be maintained to ensure the measures remain in good repair and visible. This is especially important when there are multiple subcontractors on a project which may be otherwise unaware of the sensitive or critical areas.



**PRACTICE 7.2: CONSTRUCTION SEQUENCING**

*See Chapter 7, Page 93*

*The construction sequence noted that fill slopes were to be stabilized as construction above the slopes continued.*

*Purpose and Application.* Following a specified work schedule that coordinates the timing of land-disturbing activities and the installation of control measures is perhaps the most cost-effective way of minimizing erosion and controlling sediment during construction. The removal of surface ground cover leaves a site vulnerable to accelerated erosion. Construction procedures that limit land clearing, provide the timely installation of erosion and sedimentation controls, and restore protective cover quickly can significantly reduce the erosion potential of a site.

*Description.* The construction sequence schedule is an orderly listing of all major land-disturbing activities together with the necessary erosion and sedimentation control measures planned for a project. The construction schedule must be included in the SWPPP and be modified in the field as site conditions change. This type of schedule guides the contractor on work to be done before other work is started so that serious erosion and sedimentation problems can be avoided.

*TN Requirements.* There may be specific sequencing requirements such as the time of year that clearing can occur on a project due to the presence of endangered or threatened species.

*Limitations.* Construction sequencing is done on every project to some degree by necessity due to the various trades that may be employed to construct a project. Erosion prevention and sediment control needs to be a factor considered in the construction schedule while balancing other scheduling demands. For example, a clearing contractor may want to make one trip to a project to clear the entire area even though active grading may progress more slowly resulting in cleared areas that will be subject to erosion for a long period of time placing a greater demand on sediment control measures.

*Maintenance.* Revising the construction schedule to continually consider the erosion prevention and sediment control factor along with the other competing factors such as weather, subcontractor availability, coordination of different trades, etc. is essential.

**PRACTICE 7.3: TOPSOILING**

*See Chapter 7, Page 95*

*The contractor applied topsoil over the cut slope before applying seed and mulch.*

*Purpose and Application.* Topsoil provides the major zone for root development and biological activities for plants, and should be stockpiled and spread wherever and whenever (i.e. in a timely manner) practical for establishing permanent vegetation.

*Description.* Topsoiling is a common practice where ornamental plants or high maintenance turf will be grown. It may also be required to establish vegetation on shallow soils, soils containing potentially toxic materials, very stony areas, and soils of critically low pH.

Advantages of topsoil include higher organic matter, more friable consistency, and greater available water-holding capacity and nutrient content. In addition, infiltration can be enhanced by re-spreading topsoil in areas that have been disturbed by construction activity. In some cases, however, handling costs may be too high to make this practice cost-effective. In site planning, the option of topsoiling should be compared with that of preparing a suitable seedbed in the existing subsoil.

*Limitations.* Do not place topsoil on slopes steeper than 2:1 without additional engineered slope stabilization practices to avoid slippage.

*Maintenance.* Establishment of vegetation as soon as possible after spreading topsoil is essential for preventing erosion of the topsoil.

**PRACTICE 7.4: TREE PRESERVATION**

*See Chapter 7, Page 98*



*The contractor installed chain-link fence around the “drip line” of the trees prior to construction.*

*Purpose and Application.* Preserving and protecting trees can often result in a more stable and aesthetically pleasing site. Trees stabilize the soil and help prevent erosion, decrease storm water runoff, moderate temperature, provide buffers and screens, filter pollutants from the air, supply oxygen, provide habitat for wildlife, and increase property values.

*Description.* Some desirable characteristics to consider in selecting trees to be protected include: tree vigor, tree species, tree age, tree size and shape, tree location, and use as wildlife food source. Trees on stream banks may be required to be protected if they are located in a regulated stream buffer area. Construction activities are likely to injure or kill trees unless adequate protective measures are taken close to the trees. Direct contact by equipment is the most obvious problem, but damage is also caused by root zone stress from filling, excavating, or compacting too close to trees. Trees to be saved should be clearly marked so that no construction activity will take place within the “drip line” of the tree.

*Limitations.* Isolating the areas around trees may severely limit the available land at a construction site and may require special planning by the contractor to access some parts of the project.

*Maintenance.* Tree preservation methods must be maintained to ensure the measures remain in good repair and visible. This is especially important when there are multiple subcontractors on a project which may be otherwise unaware of the sensitive or critical areas.



**PRACTICE 7.5: SURFACE TRACKING**

*See Chapter 7, Page 102*

*This slope has been tracked, seed applied and then mulched. Tracking helps control erosion, hold seed in place, and aids uniform vegetation germination.*

*Purpose and Application.* Roughening a sloping bare soil surface with horizontal depressions helps control erosion by aiding the establishment of vegetative cover with seed, reducing runoff velocity, and increasing infiltration. The depressions also trap sediment on the face of the slope.

*Description.* Tracking is typically performed with a bulldozer, working up and down a slope. Tracking should always leave horizontal tracks, as opposed to vertical tracks. Equipment such as bulldozers with rippers or tractors with disks may also be used. The final face of slopes should not be bladed or scraped to give a smooth hard finish.

*Limitations.* Consider tracking on all slopes. The amount of tracking required depends on the steepness of the slope and the type of soil. Stable rocky faces of a slope may not require tracking or stabilization, while erodible slopes steeper than 3:1 require special surface roughening. This measure needs to be used in conjunction with other practices such as temporary seeding and mulch to prevent erosion and sedimentation.

*Maintenance.* Seed and mulch should be applied as soon as practicable on a tracked slope.

**PRACTICE 7.6: STABILIZATION WITH STRAW MULCH**

See Chapter 7, Page 104

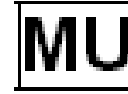

*The cut slopes have been rough graded but not final graded. Straw mulch provides a temporary groundcover that reduces erosion until the final grading can occur.*

**Purpose and Application.** Surface mulch is the most effective, practical means of controlling erosion on disturbed areas before establishing vegetation. Mulch protects the soil surface, reduces runoff velocity, increases infiltration, slows soil moisture loss, helps prevent soil crusting and sealing, moderates soil temperatures, and improves the microclimate for seed germination.

**Description.** Organic mulch such as straw is effective for general use where vegetation is to be established. Straw mulch is most effective when it has been anchored with matting, crimping or a tackifier to prevent its movement. In recent years a variety of mats and fabrics have been developed that make effective mulches for use in critical areas such as waterways and channels. Various types of tacking and netting materials are used to anchor organic mulches. Netting is generally not effective when used alone.

**TN Requirements.** Application of temporary or permanent stabilization must be initiated within 14 days to disturbed areas of a site where construction activities have temporarily or permanently ceased.

**Limitations.** Mulch is not intended to withstand the shear stress of concentrated flow; therefore, mulching a ditch must be accomplished in conjunction with other velocity reducing measures such as check dams or through the use of an engineered ditch lining material such as a turf reinforcement mat.

**Maintenance.** Maintenance of a good cover of mulch is one of the most effective erosion prevention measures because it helps prevent movement of the soil thereby reducing the need for sediment control measures. Maintenance of mulch can include but is not limited to applying more mulch where it has blown or washed away, securing the mulch through such actions as crimping or diverting run-on storm water from the mulched area to prevent future wash-outs.



**PRACTICE 7.7: STABILIZATION WITH OTHER MULCH MATERIALS**

See Chapter 7, Page 107



*Shredded wood chip mulch applied 2-3" thick can be used as temporary stabilization*

*Purpose and Application.* Surface mulch is the most effective, practical means of controlling erosion on disturbed areas before establishing vegetation. Mulch protects the soil surface, reduces runoff velocity, increases infiltration, slows soil moisture loss, helps prevent soil crusting and sealing, moderates soil temperatures, and improves the microclimate for seed germination.

*Description.* There are many types of mulches. Selection of the appropriate type of mulch should be based on the type of application, site conditions, and compatibility with planned or future uses. Besides straw mulch (practice 7.6), other materials can be used as mulches, including wood chips, shredded bark and gravel. Use of onsite materials as mulch is strongly encouraged to reduce the environmental footprint of the site. For example, trees and other vegetation cleared from the site can be ground and used as mulch material for the site.

*TN Requirements.* Application of temporary or permanent stabilization must be initiated within 14 days to disturbed areas of a site where construction activities have temporarily or permanently ceased.

*Limitations.* Some mulch materials float when in contact with stormwater runoff and should not be placed in areas receiving concentrated flow. In addition, offsite mulch materials should be certified as free from fire ants. Mulch is not intended to withstand the shear stress of concentrated flow; therefore, mulching a ditch must be accomplished in conjunction with other velocity reducing measures such as check dams or through the use of an engineered ditch lining material such as a turf reinforcement mat.

*Maintenance.* Maintenance of a good cover of mulch is one of the most effective erosion prevention measures because it helps prevent movement of the soil thereby reducing the need for sediment control measures. Maintenance of mulch can include but is not limited to applying more mulch where it has blown or washed away, securing the mulch through such actions as crimping, or diverting run-on storm water from the mulched area to prevent future wash-outs.

**PRACTICE 7.8: TEMPORARY VEGETATION**

See Chapter 7, Page 109

**TS**

*A temporary ground cover was applied to this area because final grading was not to occur until spring.*

***Purpose and Application.*** Protective cover must be established on all disturbed areas within 14 days after a phase of grading is completed. Temporary seeding and mulching are the most common methods used to meet this requirement. Temporary vegetation is used to protect earthen sediment control practices and to stabilize denuded areas that will not be brought to final grade for several weeks or months. Temporary vegetation can also provide a nurse crop for permanent vegetation, provide residue for soil protection and seedbed preparation, and help prevent dust during construction.

***Description.*** Annual plants that are adapted to site conditions and that sprout and grow rapidly should be used for temporary plantings. Proper seedbed preparation and the use of quality seed are also important.

***TN Requirements.*** Application of temporary or permanent stabilization must be initiated within 14 days to disturbed areas of a site where construction activities have temporarily or permanently ceased.

***Limitations.*** Because temporary seedings provide protective cover for less than one year, areas must be reseeded annually or planted with perennial vegetation.

***Maintenance.*** Generally, the more effort put into proper seedbed preparation, applying appropriate and adequate seed and mulch, and initial watering during germination, the less maintenance needs such as overseeding, reapplying mulch, and extended watering will be required.



**PRACTICE 7.9: PERMANENT VEGETATION**

See Chapter 7, Page 113



*Permanent vegetation is the most effective erosion prevention practice.*

**Purpose and Application.** Permanent vegetation controls erosion by physically protecting a bare soil surface from raindrop impact, flowing water, and wind. Vegetation binds soil particles together with a dense root system and reduces the velocity and volume of overland flow. It is the preferred method of surface stabilization wherever site conditions permit.

**Description.** Seeding with permanent grasses and legumes is the most common and economical means of establishing a protective cover. The advantages of seeding over other means of establishing plants include the relatively small initial cost, wide variety of grasses and legumes available, lower labor input, and ease of application. Problems to consider are potential for erosion during the establishment period, the need to reseed areas, seasonal limitations on seeding dates, weed competition, and the need for water during germination and early growth. Give special attention to selecting the most suitable plant material for the site and intended purpose. Good seedbed preparation such as topsoiling (see practice 7.3), adequate liming and fertilization, and timely planting and maintenance are also important for good germination and establishment of a permanent groundcover.

**TN Requirements.** Application of temporary or permanent stabilization must be initiated within 14 days to disturbed areas of a site where construction activities have temporarily or permanently ceased.

**Limitations.** Establishing permanent vegetation within concentrated flow paths such as swales and ditches will likely require special considerations such as rolled erosion control products (see practice 7.11) to protect the seed and seedbed during (and possibly after) germination.

**Maintenance.** Generally, the more effort put into proper seedbed preparation, applying appropriate and adequate seed and mulch, and initial watering during germination, the less maintenance needs such as overseeding, reapplying mulch, and extended watering will be required.

**PRACTICE 7.10: SOD**

See Chapter 7, Page 122



*Sod is a fast and effective method of stabilizing bare soils.*

*Purpose and Application.* Sodding provides an immediate and effective groundcover. It allows the use of vegetation to protect channels, spillways, and drop inlets where design flow velocities may reach the maximum allowable for the type of vegetation to be used. Sod is preferable to seed in waterways and swales because of the immediate protection of the channel after application. The installation of sod should also be considered in locations where a specific plant material cannot be established by seed or when immediate use is desired for aesthetics such as landscaping. Some additional advantages of sod are nearly year-round establishment capability, less chance of failure, freedom from weeds, and immediate protection of steep slopes.

*Description.* Sod consists of grass or other vegetation-covered surface soil held together by matted roots.

*Limitations.* Disadvantages include high installation costs, especially on large areas, and the necessity for irrigation in the early weeks. Sod also requires careful handling and is sensitive to transport and storage conditions.

*Maintenance.* Soil preparation, installation, and proper maintenance are as important with sod as with seed. Choosing the appropriate type of sod for site conditions and intended use is of utmost importance. Sod may need to be pinned in place on steep slopes and in channel applications.

**PRACTICE 7.11: ROLLED EROSION CONTROL PRODUCTS**

See Chapter 7, Page 126

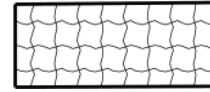

*Turf reinforcement mats are appropriate where concentrated flows exceed the design shear stress for the channel. (source: NCSU)*

**Purpose and Application.** Rolled erosion control products (RECPs) hold seed in good contact with the soil to promote seed germination and soil stabilization.

**Description.** These products are temporary degradable or long-term nondegradable material manufactured or fabricated into rolls designed to reduce soil erosion and assist in the growth, establishment and protection of vegetation. Use RECP's to help permanent vegetative stabilization of slopes 2:1 or greater and with more than 10 feet of vertical relief, as well as, channels when shear stress in the channel exceeds the allowable shear stress for the 2 year storm event.

**Limitations.** Installation is critical to the effectiveness of these products. When close ground contact is not properly achieved, runoff can concentrate under the product causing significant erosion.

**Maintenance.** Monitor the products on a regular basis to avoid significant problems caused by rainfall and high flows.



**PRACTICE 7.12: HYDRO APPLICATIONS**

See Chapter 7, Page 129



*Hydraulically applied seed, mulch and binder*

*Purpose and Application.* Hydro applications such as hydroseeding and bonded fiber matrices (BFM) are an economical means of applying and securing seed. Its greatest applications are on steep slopes with limited equipment access or on flat terrain where there will be very limited sheet flows.

*Description.* BFM's contain fibers joined together by adhesive and mineral binders to create a continuous, three dimensional erosion control blanket, which adheres to the soil surface. Hydroseeding materials typically consist of a slurry of seed, fertilizer, mulch, and a tackifier.

*Limitations.* Hydraulic mulch applications do not provide erosion protection on slopes generally greater than 4:1 or 5:1. However, BFM can be applied on steeper slopes effectively. Failure of either material is typically due to low application rates or improper mixing of materials.

*Maintenance.* Ensuring that adequate coverage of the slurry is applied is critical; otherwise, maintenance needs such as reapplication or supplementing with other forms of temporary or permanent stabilization will increase.



**PRACTICE 7.13: SOIL BINDERS AND TACKIFIERS**

See Chapter 7, Page 131

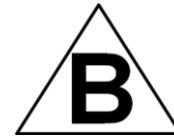

*A soil binder is sprayed over a bare soil surface that has been properly tracked (see practice 7.5).*

*Purpose and Application.* Soil binders are materials that are typically used alone to provide erosion control and surface protection for exposed soils. In general, soil binding materials do not provide the microclimatic modification that is provided by mulches or blankets and therefore do not have the same successful germination that mulches provide. They work by binding the upper layer of soil together, forming a crust on the surface so that soil particles resist being suspended in surface flows. Although they form a surface crust, most of the materials do not seal the surface to the point where infiltration is prevented, so they do not prevent the establishment of vegetation.

*Description.* Tackifiers are materials used to bind mulches together to achieve better adhesion of materials to the soil. When straw or hay mulch is spread, it must either be crimped or bound together with a tackifier to keep it from blowing away or migrating down the slope. The tacking material must be applied uniformly over the surface of the mulch or soil. The result of a properly applied tackifier is a continuous and connected blanket of mulch and tackifier.

*TN Requirements.* Application of temporary or permanent stabilization must be initiated within 14 days to disturbed areas of a site where construction activities have temporarily or permanently ceased.

*Limitations.* Soil binders are temporary and must be re-applied after exposure to rain.

*Maintenance.* Soil binders or tackifiers need to be re-applied after exposure to rain if these measures continue to be necessary because construction activities have ceased temporarily.

**PRACTICE 7.14: EMERGENCY STABILIZATION WITH PLASTIC**

See Chapter 7, Page 137



*Temporary covering was used to protect the topsoil stockpile from erosion.*

*Purpose and Application.* Exposed slopes are common around box culvert construction, utility work and stockpile areas. Often, temporary seeding of these areas is not feasible due to the slope or activity on or around them. In situations where soils are exposed and in close proximity to receiving streams, plastic sheeting can provide a temporary ground cover that prevents erosion and off site sediment discharges.

*Description.* Plastic sheeting must be anchored or held in place to prevent the material from moving. Rocks or other weight can be placed on the sheeting or the sheeting can be trenched in at the top and toe of the slope.

*Limitations.* Plastic sheeting is a very short term practice for use on exposed slopes in close proximity to streams or wetlands.

*Maintenance.* Plastic sheeting should be replaced when torn, and care should be taken when overlapping sections of plastic by doing so in a shingle fashion to shed storm water.

**PRACTICE 7.15: SOIL ENHANCEMENT**

See Chapter 7, Page 139

SE

*Development practices often lead to compacted soils, drought sensitive lawns, and high storm runoff contributing to downstream flooding.*

*Purpose and Application.* Soil enhancement refers to techniques employed at a construction project that can enhance infiltration and establishment of a permanent groundcover. Any portion of a construction site that has been graded can benefit from soil enhancement techniques.

*Description.* Soil enhancement includes the addition of materials to promote vegetative establishment and infiltration. Urban areas are plagued with drainage problems caused, in part, by poor soil management practices at new development sites. Removing the existing vegetation and disturbing and compacting soils is inherent to construction. When disturbance is unavoidable, several techniques can be employed at a site to reverse at least a portion of the damage caused to the soil structure and to increase infiltration. Those techniques include preserving and redistributing topsoil over disturbed areas, deeply tilling disturbed soils to break any crusted or hard panned soils, adding organic matter such as compost to the top 6 inches of soil, reintroducing soil biota, adjusting soil fertility to support vegetation, and planting deep rooted vegetation.

*Limitations.* These techniques must be used in conjunction with other techniques, such as rolled erosion control products, seed and mulch, to establish a permanent vegetative cover.

*Maintenance.* Continue to maintain sediment controls down gradient from areas where soil enhancement techniques are being employed. Repair erosion rills early to avoid reapplication or reworking areas where soil enhancement has been applied.



**PRACTICE 7.16: CONCRETE WASHOUT**

See Chapter 7, Page 142

CONCRETE  
WASHOUT

*Concrete washout areas should be provided on each construction site where concrete work occurs.*

*Purpose and Application.* Concrete washout areas are areas on a construction site designated for concrete trucks and other equipment to clean liquid or slurry concrete off the equipment without causing stormwater pollution. When washout areas are used, the slurry is given time to harden and then can be removed without discharging pollutants from the project.

*Description.* Concrete is a very common building material which is used in road and street construction, drainage structures, retaining walls, footings and foundations, building construction and many other applications. Concrete slurry has the potential to pollute storm water runoff, especially when washout occurs next to natural drainage channels or storm drain inlets. Concrete is most harmful to streams in the slurry form, though once hardened, it can cause blockage of storm drain systems and severely reduce the capacity of the storm drain system or waters of the state. Designated locations for concrete washout should be provided with clearly visible signage on each construction site. Concrete washout areas can be constructed above ground or below ground. They include a storage area lined with a geotextile fabric to allow infiltration of water while preventing the discharge of solids. Some liners are impermeable and rely on evaporation and concrete hardening to remove the liquid. Once the concrete has hardened, it can be busted up and removed from the project.

*TN requirements.* Measures must be contained in the SWPPP and reflected in the field to control construction related wastes, such as concrete slurry, and prevent the discharge of pollutants from the site.

*Limitations.* Do not locate concrete washout areas close to streams, sinkholes, wetlands or other sensitive features.

*Maintenance.* Remove concrete once hardened to ensure there is storage for additional concrete washout. Inspect the liner for rips and replace when necessary.

**PRACTICE 7.17: VEHICLE MAINTENANCE**

See Chapter 7, Page 145



*When fuel or lubricants are stored on a construction project, measures must be taken to prevent spills from causing storm water pollution. No measures were taken around the tanks above.*

**Purpose and Application.** Materials used to maintain and service vehicles onsite can mix with stormwater and discharge pollutants off the construction project and into waters of the state. Where solvents, fuels and other chemicals are stored on a project, precautions must be taken to prevent pollutant discharge.

**Description.** Equipment on construction sites may need maintenance during the life of the project. It is preferable for equipment to be serviced and maintained off the construction project in a location that has a treatment system in place to prevent pollutant discharges such as oil or vehicle spills. However, offsite maintenance may not be an option. Maintenance activities on construction equipment or vehicles on the construction project require specific attention to potential sources of pollution, such as fuel and lubricant drums. These materials must be handled and disposed of in a manner that prevents the material from mixing with stormwater and discharging into the storm drain system or waters of the state.

Use controls such as drip pans and containment barriers when maintenance activities occur on a project to prevent stormwater contamination. If maintenance activities require fuel and lubricant storage tanks to be stored on the project, secondary containment or weatherproof covers must be provided to prevent spills. Designate an area for vehicle maintenance and keep spill containment and cleanup materials at this location.

**Limitations.** Where spills have occurred and soils are saturated, contact TDEC's EFO. Soils may have to be excavated and treated or disposed of offsite.

**Maintenance.** Watch for signs that construction equipment needs maintenance, such as soil staining from oils and lubricants, and have equipment repaired to prevent discharges.

**PRACTICE 7.18: CHEMICAL STORAGE**

See Chapter 7, Page 147

CHEMICAL  
STORAGE

*Pouring chemicals into storm drains causes an illicit discharge of pollutants that ultimately reach waters of the state.*

**Purpose and Application.** Proper storage and disposal of chemicals on a construction site prevents or reduces the discharge of pollutants to stormwater from leaks and spills by reducing the chance for spills, stopping the source of spills, containing and cleaning up spills, properly disposing of spill materials.

**Description.** Accidental releases of materials from aboveground liquid storage tanks, drums, dumpsters, or other containers have the potential for contaminating stormwater with many different pollutants. Materials spilled, leaked, or lost from storage containers and dumpsters may accumulate in soils or on the surfaces and be carried away by stormwater runoff into waters of the state. Chemicals stored on a construction site should be stored in a weatherproof building or container. Other options include storing chemicals within a containment system. Store chemicals in a centralized location. Keep spill containment and cleanup materials at the chemical storage area. Do not washout or pour leftover chemicals into the storm drain system.

**Limitations.** Specific spill containment and clean up procedures should be developed for each site, based upon the materials being stored. Use MSDS sheets provided with the chemicals for guidance on storage, cleanup and disposal.

**Maintenance.** Ensure all employees and subcontractors on the construction project have been trained on the proper use, storage and disposal of the chemicals.



**PRACTICE 7.19: TRASH AND DEBRIS MANAGEMENT**

*See Chapter 7, Page 149*

**DEBRIS  
MANAGEMENT**

*Construction material waste and trash should be isolated and managed in designated areas to prevent offsite damage and pollution.*

*Purpose and Application.* Construction inherently produces waste materials, including building waste debris, employee-generated trash, waste concrete and asphalt. These materials can mix with stormwater and discharge off the construction site.

*Description.* Designated waste management areas should be identified throughout the construction project, separating trash from reusable or recyclable materials. Materials prone to leaching should be stored in covered dumpsters. All materials should be stored in a manner to prevent wind from blowing the material off site.

*TN Requirements.* The Construction General Permit states that the SWPPP shall include a description of controls used to reduce pollutants from materials stored on site, including storage practices to minimize exposure of the materials to storm water, and spill prevention and response.

*Limitations.* Locate trash and debris stockpile areas away from streams, storm drains, sinkholes and other sensitive features.

*Maintenance.* Ensure that any debris containment measures are in good working condition. Pick up and dispose of trash located throughout the project. Educate employees and contractors about the proper disposal of all waste.



**PRACTICE 7.20: CHECK DAM**

See Chapter 7, Page 152



*Check dams can be used to reduce velocities in channels to aid in permanent stabilization. (source: NCSU)*

**Purpose and Application.** Check dams are structures installed in channels to reduce velocities and erosion. Check dams also provide some sediment control benefit. Check dams may be installed to reduce velocity in small temporary channels that are degrading, but where permanent stabilization is impractical due to their short period of usefulness; or to reduce velocity in small eroding channels where construction delays or weather conditions prevent timely installation of non-erosive liners.

**Description.** A check dam is a small, temporary structure constructed across a drainageway (not a stream). Most check dams are constructed of rip rap. However, other manufactured check dam devices are available. Check dams must contain a center spillway section that is lower than the check dam sides. When rip rap is used, geotextile or filter fabric must be installed at the soil-rock interface. Place washed stone on the face of the rip rap check dam.

**Limitations.** The drainage area is limited to 5 acres maximum. Problems with check dams typically occur at the abutments when the sides are lower than the middle spillway, causing erosion around the abutments. Erosion can also occur at the downstream toe of the check dam. These measures must be monitored and sediment cleaned out from behind the structures to prevent overtopping and failure. In addition, ponding behind the structures must not cause a traffic hazard.

**Maintenance.** Sediment should be cleaned out from behind check dams when 50% of the storage capacity has been filled with sediment. Particular attention must be given to check dam abutments and the downstream toe, as these areas are susceptible to erosion.

**PRACTICE 7.21: DEWATERING TREATMENT PRACTICE**

See Chapter 7, Page 155

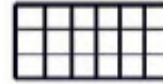

*Dewatering structures are often needed when working in a stream on the construction of box culverts.*

*Purpose and Application.* Dewatering treatment practices treat water that is pumped from excavations into the treatment areas. Treatment can include filtering, chemical flocculation, or settling of sediments prior to discharging stormwater. Dewatering treatment practices are typically necessary in conjunction with utility work and instream construction activities such as box culvert, pipe or bridge construction.

*Description.* Dewatering treatment practices are temporary practices that include manufactured and non-manufactured products. Where fine clay soils are present in stormwater runoff, chemical treatment with flocculants may be necessary. These practices must be identified and sited during SWPPP preparation to ensure that there is room for the practice and that the practice can be maintained while in use.

*Limitations.* Problems with dewatering structures typically occur when the pump discharges a higher volume of water than the structure can handle or when the structure is not maintained. Removal and disposal of geotextile bags, like the one shown above, can also cause problems if overfilled or located too close to a stream.

*Maintenance.* Ensure that the treatment practice is either cleaned out or removed once the storage is full. Visually verify that discharges from the treatment practices are not turbid. Filter bag removal method must be considered before relying on a filter bag for dewatering treatment.

**PRACTICE 7.22: DIVERSION**

See Chapter 7, Page 160

→ TD →

*Diversions convey stormwater around or through a site. They can be temporary or permanent measures.*

*Purpose and Application.* Diversions carry runoff around a construction area; to reduce slope length and minimize erosion; or to carry sediment laden runoff to a treatment practice. They can be designed as temporary or permanent measures and must be stabilized accordingly.

*Description.* Diversions can be created through excavation or by building a ridge. This practice applies to construction areas where runoff can be diverted and disposed of properly to control erosion, sedimentation, or flood damage. Specific locations and conditions include above disturbed existing slopes, and above cut or fill slopes to prevent runoff over the slope; across unprotected slopes, as slope breaks, to reduce slope length; below slopes to divert excess runoff to stabilized outlets; where needed to divert sediment-laden water to sediment traps; at or near the perimeter of the construction area to keep sediment from leaving the site; and above disturbed areas before stabilization to prevent erosion, and maintain acceptable working conditions. Temporary diversions may also serve as sediment traps when the site has been over excavated on a flat grade. They may also be used in conjunction with silt fence.

*Limitations.* Unless stabilized, diversions can exacerbate erosion prevention and sediment control on a project.

*Maintenance.* After diversions have been constructed, stabilize them against erosion. Sediment deposits should be removed to prevent overtopping of the diversion. Additional erosion controls, such as check dams, may be necessary to reduce erosion.



**PRACTICE 7.23: OUTLET PROTECTION**

See Chapter 7, Page 165



*Outlet protection is necessary at the outlets of pipes, ditches and other conveyances where shear stress exceeds the allowable shear stress for grass-lined channels.*

*Purpose and Application.* Outlet protection provides permanent stabilization for the material at the outlet of the pipe, channel or other conveyance system. Outlet protection is also needed at outlets to temporary slope drains to prevent scour while the slope drain is in place.

*Description.* Outlet protection can be constructed of many different types of erosion-resistant materials but must be designed based upon the velocity and shear stress at the outlet of the conveyance. Rip rap is a common outlet protection material. Outlet protection must be keyed into the existing ground and constructed as close to a zero grade as possible. For rip rap outlet protection, a geotextile underlayment or filter fabric is required to prevent piping.

*TN Requirements.* Outfall installation and outlet protection at the end of a stream crossing within a stream must always be specifically permitted through the Aquatic Resource Alteration Permit for the culvert or bridge.

*Limitations.* An often-overlooked consideration in outlet protection installation is the over excavation required to sufficiently key in the riprap. In addition, the size of riprap required to withstand the force of the water exiting the pipe may be prohibitive (i.e. too large) and other methods may need to be considered.

*Maintenance.* Monitoring for bypassing of the outlet protection and scour of the surrounding area is critical. This is a common problem when the outlet protection has either not been sufficiently keyed into the soil or the outlet protection is not sufficiently wide.

**PRACTICE 7.24: SLOPE DRAIN**

See Chapter 7, Page 173



*The goal of a slope drain is to convey stormwater down a slope to prevent erosion while the slope is being stabilized.*

**Purpose and Application.** Slope drains are temporary measures that are used where sheet or concentrated storm water flow could cause erosion as it moves down the face of a slope to prevent erosion from sheet or concentrated flow on or below the slope. Special attention is needed at entrance, tight joints, pipe anchors, and exit. These structures are removed once the slope has been stabilized and the permanent storm water conveyance system has been installed.

**Description.** Temporary slope drains consist of flexible tubing or conduit extending from the top to the bottom of a cut or fill slope. Sediment controls are installed at the inlet and erosion controls at the outlet. Prior to installing slopes drains, the slope being protected must be stabilized.

**Limitations.** The maximum drainage area to any one slope drain is 1 acre.

**Maintenance.** Stabilize the diversion berm at the top of the slope. Ensure that the slope drain is located in the low point above the slope. Remove sediment from the sediment control practice when 50% of the sediment storage volume has been filled. Ensure that the slope drain has been secured properly to the slope to prevent disconnection of pipe joints. Failure of the slope drains can occur when the anchor berm installed over the slope drain at the top of the slope hasn't been compacted or stabilized.

**PRACTICE 7.25: TUBES AND WATTLES**

See Chapter 7, Page 177

-)-)-)

*Wattles are used primarily as a flow interruption device to slow the velocity of storm water runoff across slopes and in roadside ditches and swales.*

*Purpose and Application.* Wattles and tubes may be utilized on slopes or in small ditches to reduce flow velocities. While they are generally used at regular intervals on a slope, they may also be placed at the top or toe of the slope or at breaks in grade.

*Description.* Wattles and tubes consist of flexible tubes of biodegradable netting or geotextile fabric filled with natural fibers, hardwood mulch or other porous material. The filler material must have sufficient density to hold its shape when saturated, but must also have sufficient open space to allow sediment-laden water to pass through. These measures act to slow flow velocities so that sediments being carried in the runoff can drop out. The middle section of the wattle, tube or sock should be lower than the ends to prevent scour around the ends, and they must be securely staked in place. Manufacturer's installation instructions must be followed.

*Limitations.* Biodegradable wattles and tubes have a limited lifespan and may have to be replaced during the project. Wattles and tubes may have to be stacked to provide adequate erosion control.

*Maintenance.* Ensure flow is not bypassing the structures and that no evidence of scour is present on the downstream toe. Remove deposited sediments when 50% of the storage height is filled.



**PRACTICE 7.26: LEVEL SPREADER**

See Chapter 7, Page 180

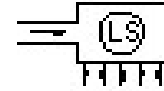

*Level spreaders convert concentrated flow into sheet flow. (Source: NCSU)*

**Purpose and Application.** Level spreaders convert concentrated flow to sheet flow. The most prevalent application of level spreaders is converting concentrated flow into sheet flow before discharging into stream buffers.

**Description.** Level spreaders can be constructed out of many different materials. They consist of a conveyance (a channel or diversion), energy dissipation, a ponding area, and a level lip. Stormwater should flow as sheet flow across the level lip. Construct level spreaders in undisturbed soil. The lip must be level to ensure uniform spreading of storm runoff, and the outlet slope uniform to prevent the flow from concentrating. Water containing high sediment loads should enter a sediment trap before release in a level spreader. The drainage area limitation is 5 acres and the spreader must be sized based on design runoff.

**Limitations.** If the lip of the level spreader is not level, stormwater will re-concentrate and cause erosion.

**Maintenance.** All areas draining to the level spreader must be stabilized. Sediment and other debris must be removed from the ponding area to prevent bypassing. Repair erosion areas.



**PRACTICE 7.27: CHANNEL LININGS**

See Chapter 7, Page 184

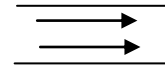

*Stabilized channels convey stormwater non-erosively, encouraging infiltration and filtering runoff.*

*Purpose and Application.* Channels are permanent structures that convey concentrated runoff. Many methods of permanent stabilization are available, including vegetation, vegetation with a permanent liner, rip rap, and concrete.

*Description.* The preferred channel lining is vegetation. Grass lined channels provide benefits above simply conveying stormwater runoff while maintaining a stable channel. The grass provides some filtering of stormwater after the site has been stabilized. In addition, grass lined channels are typically on gentle slopes with low velocities and promote infiltration. As shear stresses and slopes increase, rolled erosion control products (RECPs) should be incorporated into the channel stabilization design, leaving rip rap and concrete lined channels as the last options for stabilization, only where site conditions will not allow stabilization with grass and a liner (temporary or permanent). Temporary linings should be designed based upon the 2 year storm, while permanent linings are designed based upon the 10 year storm.

*Limitations.* Channels are designed based upon the 2-year and 10-year storm events. Storms larger than the design storm can cause channel linings to fail.

*Maintenance.* Once established, grass lined channels are easier to maintain long term than rip rap and concrete lined channels. However, once the channels are temporarily or permanently stabilized, they should be protected from construction activity – particularly runoff with heavy loads of sediment.

**PRACTICE 7.28: CONSTRUCTION EXIT**

*See Chapter 7, Page 205*

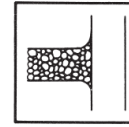

*Rock construction exits should be installed at each location that construction traffic leaves the construction project.*

*Purpose and Application.* Construction exits are temporary sediment control devices installed where ever construction traffic leaves an active construction site. Most often, construction exits are constructed of clean stone. However, several manufactured construction exits are available that do not include stone.

*Description.* Construction exits reduce or eliminate the transport of sediment from the construction site onto a public right of way. Rock construction exits should be constructed with 2"-3" sized clean stone, installed at least 6" deep. A geotextile underliner must be installed under the rock to prevent sediment from piping up through the rock from the underlying soil surface. In addition, the geotextile fabric underliner makes maintenance of construction exists easier. The rock construction entrance should extend the full width of the entrance area, sufficiently long for vehicles to drop mud and sediment and stable enough for construction traffic. Avoid entrances on steep grades or at curves in public roads. Stormwater must be properly managed around the construction exit to prevent washing sediment off the construction exit. In situations where a properly installed and maintained construction exit does not adequately clean tires before leaving the construction site, a more robust tire washing facility (see practice 7.29) may be necessary.

*Limitations.* Soils that contain a high percentage of clay may require a more robust tire washing facility.

*Maintenance.* When visual inspections note an excessive build up of sediment on the construction exit, the sediment and rock should be removed and replaced with clean stone. Sediment tracked off the construction project must be cleaned up before the next rain event or within 7 days, whichever is shorter.

**PRACTICE 7.29: TIRE WASHING FACILITY**

*See Chapter 7, Page 209*

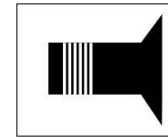

*Where tire washing facilities are installed, particular attention should be given to runoff management to prevent sediment from being discharged from the site.*

*Purpose and Application.* Tire washing facilities should be used where rock construction exits do not provide adequate protection from tracking sediment and mud off the construction sites. Sites with high clay content soils may benefit from tire washing facilities. Long term construction projects may also benefit from tire washing facilities.

*Description.* Several different types of tire washing facilities can be constructed based upon the project longevity and the desire for an active or passive washing facility. Washing facilities can simply be a cattle guard design coupled with a water source and hose with sprayer or more robust such as a pre-fabricated tire washing facility. The washing facility must have provisions for intercepting and treating the sediment-laden wash water and directing it into a deposition area.

*Limitations.* If using this practice, an adequate source of water must be provided. In addition, the dirty water generated by the washing activity must be directed to a sediment basin or trap to be treated before being discharged. Stormwater runoff and process water handling around the tire washing facility must be adequately addressed in the SWPPP and throughout the life of construction to avoid traffic hazards and the discharge of untreated process water.

*Maintenance.* When visual inspections note sediment deposition in the wash water treatment practices, sediment must be removed and properly disposed. Sediment tracked off the construction project must be cleaned up before the next rain event or within 7 days, whichever is shorter.



**PRACTICE 7.30: FILTER RING**

See Chapter 7, Page 212



*Filter rings should be part of an overall system of BMPs. Above, the filter ring is providing sediment control while the mulch is providing erosion control.*

*Purpose and Application.* Filter rings are temporary sediment controls, constructed of rip rap and installed at the entrance to storm drains and culverts. To enhance settling, washed stone is placed on the upstream face of the filter ring.

*Description.* Filter rings include the rock berm and sediment storage area. They are installed at the entrance to storm drains and prevent sediment from entering, accumulating in and being transferred through the culvert or storm drain system. Filter rings are installed with a sediment storage area on the upstream side of the filter ring to aid in sediment deposition. Geotextile fabric is installed at the interface between the rock and soil to prevent piping under the structure.

*Limitations.* These practices are used at storm drain inlets with large drainage areas or at drop inlets that receive high velocity water flows, possibly from many directions. Sediment is captured in an excavated depression surrounding the inlet. When drainage area exceeds 1 acre, additional measures are necessary. This practice must not divert water away from the storm drain.

*Maintenance.* Sediment deposits must be cleaned out when half the storage capacity of the sediment deposition area has been filled. **It is important that all stormwater flow over the structure into the storm drain, and not past the structure.** Temporary diking below the structure may be necessary to prevent bypass flow.

**PRACTICE 7.31: SEDIMENT BASIN**

See Chapter 7, Page 215



*A slotted drain pipe has been installed to dewater this basin. Note that discharge doesn't occur from this basin until the water level in the storage area reaches the bottom of the slotted drain pipe.*

**Purpose and Application.** Sediment basins are temporary engineered structures designed to capture sediment from construction site stormwater runoff prior to being discharged.

**Description.** Sediment basins contain the following components: an embankment, a sediment storage area, a permanent pool, a sediment forebay, a principal and emergency spillway system, outlet protection at the outlet of the spillway barrel, and a dewatering mechanism. Sediment basins are constructed by building a low earthen dam across a drainageway, by excavating a storage area, or by a combination of both to form the sediment storage pool. A properly designed spillway outlet system with adequate freeboard is essential. The embankment should be well compacted and vegetated. A permanent pool of water is required to provide better settling efficiency, and dewatering from the top of the basin pool is required to also aid in settling efficiency.

**TN Requirements.** For an outfall in a drainage area of a total of 10 or more acres, a temporary sediment basin (or equivalent controls) is required that provides storage and a spillway system for controlling runoff from a 2 year, 24 hour storm for each acre drained. For impaired and high quality waters, sediment basins are required for a drainage area of 5 or more acres, and the basin must be designed to control volume of runoff from a 5 year, 24 hour storm. A permanent pool must be designed into the sediment storage zone. In addition, a sediment forebay is required to aid in maintenance. Discharges from sediment basins cannot cause an objectionable color contrast with the receiving stream.

**Limitations.** Sediment basins must be designed by an engineer or landscape architect. Basins typically require large areas for adequate settling, as the crucial design component for basins is available sediment storage zone surface area. A 4:1 length to width ratio is required.

**Maintenance.** Ease of basin cleanout and spoil disposal must be considered in site selection. The forebay decreases the frequency of dredging or cleaning out the sediment storage area in the basin.

**PRACTICE 7.32: SEDIMENT TRAP**

See Chapter 7, Page 241



*Half of the sediment storage volume should be in wet storage or a permanent pool to increase settling efficiency.*

*Purpose and Application.* Sediment traps are temporary ponding areas formed by excavating a sediment storage area and constructing an earthen embankment with a simple rip rap spillway. They serve small drainage areas.

*Description.* Sediment traps have sediment storage areas, a permanent pool, an embankment, a spillway, and often also have porous baffles. Sediment traps should be constructed as a first step in any land disturbing activity, often in conjunction with diversions and other temporary measures. Geotextile fabric is installed at the interface of the rock spillway and soil. Sediment trap trapping efficiency can be improved by installing one or more baffles in the sediment storage area to remove turbulent flow, increasing the flow length through the measure, or facing the rip rap spillway with washed stone.

*Limitations.* The drainage area limitation for sediment traps is 5 acres or less of total contributing area. Supplemental stormwater runoff treatment may be necessary for clayey soils to lower the turbidity.

*Maintenance.* Sediment should be removed when 50% of the storage capacity has been filled with sediment to prevent overtopping and failure of the measure. Access to the sediment trap must be considered in the design and location of traps to facilitate cleanout. Ensure that stormwater doesn't bypass the measure by constructing diversions and/or berms to direct flow into the trap.



**PRACTICE 7.33: BAFFLES**

See Chapter 7, Page 246



*Baffles increase the settling efficiency of sediment traps and basins.*

*Purpose and Application.* Porous barriers installed in sediment basins, sediment traps, or skimmer basins to reduce the velocity and turbulent flow of the water flowing through the structure. Baffles facilitate settling and sediment before discharge.

*Description.* Baffles are constructed out of porous materials such as jute or coir and installed perpendicular to flow through the practice. Two to three baffles should be installed in each sediment storage area to divide the storage area into deposition zones. Polymers, such as polyacrylamide, can be used in conjunction with baffles to greatly improve settling in the practice.

*Limitations.* Baffles should not be installed immediately down gradient from pipe outlets. It is essential to install the measure securely to avoid blow outs and other malfunctions. If baffles aren't installed correctly, short-circuiting around the sides or scour along the toe can occur.

*Maintenance.* The design life of the fabric is 6-12 months, but may need to be replaced more often if clogging occurs. Also, the majority of the settling in the sediment storage area will occur above the first baffle, making clean out of basins and traps easier.



**PRACTICE 7.34: SILT FENCE**

*See Chapter 7, Page 250*



*Properly installed silt fence provides good sediment control around the perimeter of a construction site.*

*Purpose and Application.* Silt fence is a permeable sediment barrier erected near small disturbed areas to capture sediment from sheet flow. Silt fence reduces the velocity of flow, allows deposition, and retains sediment. Silt fence should be installed along the contour to encourage sheet flow.

*Description.* Temporary silt fence is composed of woven geotextile fabric supported by steel or hardwood posts, buried at the bottom. The permeability of the fabric is fairly low, so that water can pass through it only slowly. This causes stormwater runoff from disturbed areas to form a pool on the upstream side of the fence so that sediments can settle out, thus preventing them from leaving the construction site. Because silt fence is not designed to withstand high heads, the drainage area must be restricted and the fence located so that water depth does not exceed 1.5 feet at any point. Silt fence may be designed to store all the runoff from the design storm, or located to allow bypass flow when the temporary sediment pool reaches a predetermined level.

*Limitations.* The maximum drainage area to a section of silt fence is  $\frac{1}{4}$  acre per 100 feet of silt fence. However, as drainage area slopes increase, the treatment capability of silt fence decreases. In addition, silt fence is not allowed in areas of concentrated flows, as flow capacities of the silt fence fabric will be exceeded and the silt fence will fail. Concentrated flow areas include channels and pipe outlets. Where sections of silt fence are joined, these joints can become failure points if the joints are not constructed correctly.

*Maintenance.* The effectiveness of silt fence is largely dependent on the proper installation and maintenance. Sediment should be removed from behind the silt fence when half the storage depth has been filled. If runoff concentrates along the toe of the silt fence, erosion will occur. J-hooks or stable silt fence outlets should be considered in these areas. Silt fence should be maintained or replaced when it begins to sag, as sagging points typically are points of overtopping and downstream scour. The design life of silt fence fabric is 6-12 months.

**PRACTICE 7.35: INLET PROTECTION**

See Chapter 7, Page 258

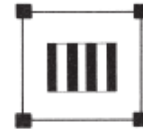

*The effectiveness of inlet protection is dependent on routine maintenance.*

**Purpose and Application.** Inlet protection is installed at the entrance to storm drain systems to prevent sediment from construction sites from getting into the storm drain system.

**Description.** Inlet protection practices can be manufactured devices or can be constructed on the project. All inlet protection devices have the following components: a sediment storage area, a sediment barrier or filter, and a stormwater overflow mechanism to manage larger storm events. Inlet protection measures provide filtration or a temporary detention area to allow settling. Where filtration is the primary means of providing protection careful maintenance of the filter media is essential. Silt fence inlet protection must have bracing installed to prevent inward collapse of the structure.

**Limitations.** Inlet protection devices can only manage runoff from one acre or less per structure. These devices should be installed as secondary sediment control measures, as their effectiveness is low. Ponding behind inlet protection can cause a traffic hazard, if the device is located near travel lanes. Drop inlets are often in series, and when an upstream measure is bypassed due to clogging or lack of storage, downstream measures will fail as the drainage areas for downstream measures will increase.

**Maintenance.** If filter fabric gets clogged, significant ponding will occur and the BMP is likely to fail. Replace the filter fabric when evidence of clogging is visually noted. Sediment should be removed when 50% of the sediment storage volume has been filled with sediment or other debris. Diversions and/or berms may be needed to prevent stormwater runoff from bypassing treatment.

**PRACTICE 7.36: CONSTRUCTION ROAD STABILIZATION**

See Chapter 7, Page 269

**CRS**

*The construction roadway has been stabilized with stone to prevent erosion of the roadbed.*

*Purpose and Application.* Construction road stabilization techniques should be applied to all temporary or permanent construction access routes, haul roads, on-site vehicle transportation routes, and construction parking areas to prevent erosion. This will reduce erosion and subsequent re-grading of permanent roadbeds between time of grading and final stabilization. Unstabilized roadways can generate sediment and/or dust. During wet weather, unstabilized roads can become unusable, causing a delay in construction.

*Description.* Construction roads and parking areas should be stabilized early in the project. Different types of materials can be used to stabilize these areas; however, gravel and other types of rock are the most prevalent material used for stabilization. If crusher run is used, the fine material in the mix must be managed so it does not contribute to off-site sedimentation or turbidity. Maintain and monitor construction exits when crusher run is used for construction road stabilization (crusher run is NOT allowed for construction exits). Regardless of the material used, controlling surface runoff from the roadway and adjoining areas is a key erosion control consideration.

*Limitations.* Avoid steep slopes, wet or rocky areas, and highly erosive soils.

*Maintenance.* Where material migrates off the roadway or wears thin, the construction roadway or parking area may need another application of rock. Topdress with new gravel as needed. Inspect drainage ditches and other areas for evidence of rock and sediment migration from the roadway.



**PRACTICE 7.37: TUBES AND WATTLES (SEDIMENT CONTROL)**

See Chapter 7, Page 273



*Wattles and tubes perform as velocity reduction and sediment reduction practices, and many are biodegradable.*

*Purpose and Application.* Wattles and tubes can be used as velocity reduction or sediment control practices, depending on the application. For this practice, the focus is on sediment control. Their primary sediment control applications are: 1) installed on slopes to slow sheet flow, promote infiltration, trap sediment and reduce runoff volume; 2) installed around storm drain inlets to prevent sediment from migrating into the storm drain system; and 3) installed along the perimeter of a small site with minimal slope to slow sheet flow and promote sediment deposition. These practices can be used in place of silt fence at the perimeter of a small site. They are very good practices to install on a residential lot.

*Description.* Wattles and tubes have a mesh or netting material around an inner filter media material. Some wattles and socks are fully biodegradable, while others have degradable components. All wattles and tubes must have an intimate contact with the ground to prevent piping under the measure. The ends of wattles and tubes should extend up the sides of channels and ditches when installed in areas of concentrated flow. Design is based upon the primary application as either a velocity control in channels and ditches or as sediment control.

*Limitations.* Common diameters of these practices are from 8" to 20". Sediment storage area behind these measures is, therefore, limited. Wattles and tubes must be staked down so they can't be installed on pavement or rock.

*Maintenance.* Depending on the material, these practices can have a very short life span (3-6 months) or a longer life span (12 months or more). The maintenance plan accompanying the EPSC plan should clearly identify the expected life span for the practice being used. An advantage of using biodegradable wattles or socks is realized when construction is complete and measures are being removed. For many wattles and socks with biodegradable filter material inside webbing, the webbing can be cut and removed, leaving the filter media in place.

**PRACTICE 7.38: FILTER BERM**

See Chapter 7, Page 276

— F Berm — — F Berm — — F Berm — —

*Filter berm installed with silt fence to prevent mulch migration  
(Source: TDOT, SR840, Williamson County)*

*Purpose and Application.* Filter berms act first by reducing runoff flow velocities so that eroded sediments can be settled upstream of the filter. They also act to filter the runoff as it passes through the materials in the berm. Filter berms are installed along the contour to intercept sheet flow. Filter berms may also be used where silt fence would not be feasible due to exposed rock or other conditions which would prevent the fence from being trenched in.

*Description.* Filter berms are a linear sediment trapping measure composed of wood chips. Woody material that is ground onsite can be used to construct filter berms if the material is not composted before use. To prevent the migration of mulch materials, the berms can be installed in conjunction with other measures such as silt fence (see the picture at the top). Compost material should be avoided, due to its potential to leach nutrients and cause a color contrast. The maximum drainage area to a section of filter berm is  $\frac{1}{4}$  acre per 100 feet of berm. However, as drainage area slopes increase, the treatment capability of filter berms decreases.

*Limitations.* Mulch is highly effective at solids reduction. However, some filter berm materials can leach nutrients and should not be installed near nutrient sensitive streams. Filter berms should not be installed in areas of concentrated flow. Even in areas of high sheet flow, filter berm material may have a tendency to migrate due to the buoyancy of the mulch material.

*Maintenance.* Repair filter berms if material migrates or the berm is breached. It may be necessary to install additional downstream measures to prevent mulch migration, such as silt fence. Once the project has been completed, filter berms can be knocked down and seeded.



**PRACTICE 7.39: TURBIDITY CURTAIN**

See Chapter 7, Page 279

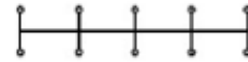

*Turbidity curtains isolate active work areas in a stream or on the bank of a stream from the rest of the stream, minimizing sediment movement from the work area.*

*Purpose and Application.* Turbidity curtains may be applied adjacent to the shoreline of a river or lake to contain sediments which may be carried into the water by construction site runoff. They should be considered only where adequate or conventional shoreline sediment control measures are not feasible or possible. They may also be used to surround a work site within the channel of a river (i.e. bridge pier construction, dredging or filling) or within a larger water body in order to prevent worksite sediments from being dispersed.

*Description.* An in-stream sediment control measure is designed to trap or filter sediment, not to halt the movement of the water itself. This device consists of a filter fabric curtain suspended from floats and held vertically in the water by means of a bottom ballast chain. This measure is placed around a construction site located either adjacent to, or within a water body, to provide an isolated work zone where sediments generated by the project can settle. In this way, it prevents the migration of these sediments into the larger remaining water body.

*Limitations.* Turbidity curtains should not be considered a primary sediment control and should not be installed across flowing water. This practice should not be applied where anticipated flow velocities will exceed 5 ft./sec.

*Maintenance.* Repair ripped or separated sections. If water elevation changes significantly causing the floating turbidity curtain to fail, the mooring and anchoring system may need to be adjusted.

**PRACTICE 7.40: FLOCCULANTS**

See Chapter 7, Page 282



*A flocculant log has been installed at the end of the pipe in turbulent flow to mix the flocculant and stormwater. A sediment basin has been installed below this pipe to provide a settling zone for the flocs.*

**Purpose and Application.** Flocculants are chemicals that are used to reduce turbidity in stormwater runoff. Construction sites with clayey soils benefit from the addition of a flocculant. Flocculants are typically applied in a treatment train approach that provides a mixing zone, settling zone and polishing zone.

**Description.** Flocculation is the process of causing small, suspended materials to stick to each other to form “flocs”. These flocs more readily settle out compared to the individual particles. Soil that is exposed during construction or stormwater runoff can be picked up and carried to the nearest water conveyance. As the flow rate slows, the larger sand or pebble particles will settle out of the water, however, the smaller particles take a much longer time to settle out. The flocculants will cause the clay particles to clump together and settle out more quickly. Many types of flocculants are available such as Polyacrylamide (PAM), gypsum and other coagulants. However, sediment at each site must be evaluated for responsiveness to the flocculant. PAM comes in solid (floc logs), liquid, and powder form. Most other flocculants come in powder form. Flocculants are typically introduced in ditches or at pipe outlets to encourage mixing. The treatment train approach is necessary to provide mixing zones in a ditch or other turbulent flow area, a settling area such as a sediment basin, and final polishing through a skimmer or other dewatering device. Anionic PAM is acceptable for use in TN. Cationic PAM is not allowed because of its toxicity to fish and aquatic life.

**Limitations.** A treatment train must be provided that introduces the flocculant upgradient from the settling zone.

**Maintenance.** The flocculant will need to be replaced routinely, with the frequency of replacement directly tied to the form of flocculant used. Visual monitoring of the discharge quality of runoff below the treatment train system using flocculant should be performed to ensure that the flocs are settling in the settling area.

**PRACTICE 7.41: STREAM BUFFERS**

*See Chapter 7, Page 286*

**STREAM BUFFER  
DO NOT DISTURB**

*While the vegetation may not look desirable, the buffer area between the construction project and the river has not been disturbed.*

**Purpose and Application.** Stream buffers have numerous benefits including increased stormwater infiltration and reduced runoff; final polishing of storm water before it's discharged to a stream; habitat creation or protection; and stream corridor protection. Deep rooted vegetation in the buffer area also provides streambank protection and shade to the stream.

**Description.** A stream buffer is a strip of undisturbed, natural, restored or enhanced vegetation between an active construction site and a stream. Stream buffers are not primary sediment controls and are easily overwhelmed by sediment-laden runoff. Primary sediment controls should treat stormwater runoff prior to discharging into a buffer. Buffers should be identified prior to the start of land disturbing activities and clearly marked throughout the life of the construction activity. Construction equipment should be prevented from entering or disturbing buffers. Construction related materials should not be stored in buffers. Stormwater must be maintained as sheet flow across the length of the buffer to prevent erosion.

**TN Requirements.** For sites that contain and/or are adjacent to a receiving stream designated as impaired or Exceptional Tennessee waters a 60-foot natural riparian buffer zone adjacent to the receiving stream shall be preserved, to the maximum extent practicable, during construction activities at the site. The natural buffer zone should be established between the top of stream bank and the disturbed construction area. The 60-foot criterion for the width of the buffer zone can be established on an average width basis at a project, as long as the minimum width of the buffer zone is more than 30 feet at any measured location.

A 30-foot natural riparian buffer zone adjacent to all streams at the construction site shall be preserved, to the maximum extent practicable, during construction activities at the site. The riparian buffer zone should be preserved between the top of stream bank and the disturbed construction area. The 30-foot criterion for the width of the buffer zone can be established on an average width basis at a project, as long as the minimum width of the buffer zone is more than 15 feet at any measured location.

*Limitations.* Stormwater must enter and flow through the buffer as sheet flow. Level spreaders may be required to turn concentrated flow into sheet flow.

*Maintenance.* Where sediment deposits are identified in buffers, the sediment should be removed by hand, raked out and stabilized, or seeded in place if the deposition will not negatively affect flow through the buffer. Erosion in the buffer must be repaired once identified. Level spreaders should be installed to maintain sheet flow through the buffer.



**PRACTICE 7.42: STREAM DIVERSION CHANNEL**

See Chapter 7, Page 289



When work is occurring in the natural stream channel, the stream is often diverted around the work area and carried in a stabilized diversion channel.

*Purpose and Application.* Stream diversion channels are constructed to allow construction in the natural stream channel under dry conditions. Lined stream diversions non-erosively carry the stream flow while isolating it from the active work zone.

*Description.* Stream diversion channels are temporary structures that non-erosively convey streams around the work zone and reconnect with the natural stream channel below the work zone. Materials that can be used to stabilize the diversion include geotextile fabric, heavy plastic sheeting, and rock. They are used to allow in-stream work to be completed in the dry, separate from flowing water. This reduces the amount of sedimentation which will occur in the stream as a result of the construction activity. Upstream and downstream plugs must be installed in the natural channel to prevent the stream from flowing into the natural channel and into the work zone. Once the work in the natural channel has been completed, the stream is directed back into the stabilized natural channel and the stream diversion channel is removed.

*TN Requirements.* **All work in a stream must have prior approval from TDEC through the Aquatic Resource Alteration Permit process and all conditions of the ARAP must be followed.**

*Limitations.* Space limitations around the stream must be considered when preparing the stream diversion channel design. Sediment controls cannot be placed in the diversion channel while it is carrying the stream flow. Work around a stream should be planned to minimize the length of time the diversion will be required.

*Maintenance.* When a storm event occurs that breaches a stream diversion plug, the plug must be re-established as soon as possible. A non-erodible lining must be maintained on all sections of the stream diversion channel and replaced or repaired if torn or loose.

**PRACTICE 7.43: TEMPORARY STREAM CROSSING**

*See Chapter 7, Page 299*

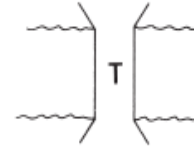

*Clean stone should be used in temporary stream crossings to prevent the migration of fines into the stream.*

**Purpose and Application.** Temporary stream crossings allow construction equipment to cross a stream without negatively impacting the stream. They should be installed anywhere construction activity crosses a stream channel, even when the channel is dry.

**Description.** Stream crossings are of three general types: bridges, culverts, and fords. In selecting a stream crossing practice consider: frequency and kind of use, stream channel conditions, overflow areas, potential flood damage, surface runoff control, safety requirements, and installation and maintenance costs. Temporary crossings may overflow during peak storm periods, however, the structure and approaches must remain stable. Clean stone should be used for temporary stream crossings. If fines are included in the stone mix, the fines can migrate downstream and cause sedimentation or water quality problems. The stream should also be isolated from the active work area.

**TN Requirements.** **All work in a stream must have prior approval from TDEC through the Aquatic Resource Alteration Permit process and all conditions of the ARAP must be followed.**

**Limitations.** Incorrectly designed or installed stream crossings can be direct sources of water pollution and flooding. They can also be expensive to construct. If washed out or damaged, they can also cause costly construction delays.

**Maintenance.** Ensure that flow is maintained through the stream crossings. Remove debris and any blockages. Isolate the stream from the active work areas.

**PRACTICE 7.44: BIOENGINEERED STREAMBANK STABILIZATION**

See Chapter 7, Page 303



*Vegetation and structural components are used together to stabilize streambanks. In the picture above, the coir rolls are used to reinforce the toe against erosive velocities.*

*Purpose and Application.* Bioengineered streambank stabilization incorporates natural and readily available plant material as well as engineered controls. Anywhere streambanks are disturbed, the preferred method for stabilization is to use bioengineered techniques.

*Description.* Bioengineered streambank stabilization involves using natural materials such as root wads, coconut fiber rolls, and rock veins to direct stream flow away from eroding banks and stabilize the bank. Bioengineering is the preferred method of streambank stabilization.

Some streambank stabilization designs involve redirecting stream forces through deflection or creating settling zones. It is highly recommended that individuals with specialized geomorphological design experience be consulted when working in the stream and changing flow patterns. Improperly designed or placed veins or deflectors can cause more damage to the streambank. Such detailed geomorphological analysis and design of streams is not covered in this design manual.

***TN Requirements.* All work on streambanks must be conducted in accordance with a valid Aquatic Resource Alteration Permit.**

*Limitations.* Vegetative and structural materials used to stabilize the stream must not reduce the hydraulic capacity of the stream channel. Sediment control must be practiced to isolate the active construction area from the stream to the extent feasible.

*Maintenance.* The streambank being stabilized must be monitored while vegetation is getting established to quickly repair damaged vegetation and erosion that may occur. In addition, the channel may need to have routine maintenance on the vegetation after it has established to maintain the hydraulic capacity of the channel.



## 5.0 PREPARING THE SWPPP

This section is designed to aid the engineer or plan preparer in the development and implementation of an effective stormwater pollution prevention plan (SWPPP).

A SWPPP is a site-specific, written document that:

- Identifies potential sources of pollution at the construction site;
- Describes practices to reduce pollutants
- Describes practices to reduce the quantity of stormwater discharges from the construction site during and after construction
- Identifies procedures the operator will implement to comply with the terms and conditions of a construction general permit.
- Is updated as conditions change on the project.

Operators of construction activities disturbing one or more acre of land, or less than one acre if the site is part of a larger common plan of development, must develop and submit a site-specific comprehensive SWPPP with a NOI for coverage under the CGP along with the associated permit fee to the TDEC field office to gain coverage. The initial, comprehensive SWPPP developed and submitted by the initial permittee (typically owner/developer) should address all construction-related activities from the date construction commences to the date of termination of permit coverage. The SWPPP must be prepared prior to submission of an NOI, and it must be developed, implemented, and updated according to the CGP. SWPPPs should be prepared in accordance with Management Practices in Sections 7, 8 and 9 of this manual, which describe practices to be used to reduce pollutants in stormwater discharges from the construction site. A SWPPP is designed to provide information to planners, developers, engineers, and contractors on the proper selection, installation, and maintenance of Management Practices. It identifies all potential sources of pollution which are likely to affect the quality of stormwater discharges from the construction site. SWPPPs must also be prepared in accordance with good engineering practices. Where a SWPPP includes structural, hydraulic or hydrologic design, it must be prepared by a licensed registered engineer or landscape architect. Individuals with a working knowledge of EPSC, such as Certified Professionals in Erosion and Sediment Control (CPESCs) Level II, can develop the narrative portion.

An example of a SWPPP can be found in Appendix C.



## 5.1 PRINCIPLES OF A SWPPP

The SWPPP should outline the steps to be taken to comply with the terms and conditions of the CGP. Keeping the following principles in mind in preparing the SWPPP will help address permit requirements and protect water quality. Using the information collected during the site analysis, apply these principles to the overall development plan.

- ***Fit the development to the site***  
Follow the natural contours as much as possible. Design the development to work with the natural features on the property, such as floodplain areas, stream buffers, steep slopes, and soils. Consider how these areas will affect your site development costs, stormwater management, and erosion control.
- ***Minimize the area and duration of exposed soils***  
Clear only the land that will be under construction in the near future, a practice known as construction phasing. Minimize the duration of soil exposure by stabilizing soils as soon as possible.
- ***Avoid disturbing critical areas***  
Areas such as sinkholes, wetlands and stream buffers should be preserved when possible, as these features provide long term stormwater management and water quality benefits to the property. Also, avoid highly erodible soils and steep slopes to the extent feasible. Avoiding these areas greatly reduces the potential for EPSC measure failure.
- ***Minimize impervious surfaces***  
Impervious surfaces are hardened surfaces such as concrete or asphalt pavement and rooftops. These surfaces prevent rainfall from infiltrating into the ground and increase the amount (volume) of stormwater runoff. Stormwater runoff is the mechanism by which pollutants are transported to streams. Minimizing the use of impervious surfaces on a development minimizes the potential stormwater impact a development site may have on natural resources. Consider incorporating pervious areas into the overall development plan to facilitate runoff infiltration.
- ***Manage stormwater***  
Divert stormwater coming on to the site by conveying it safely around, through, or under the construction site. Avoid allowing run-on to mix with runoff from the disturbed areas of the construction site.
- ***Limit potential for other stormwater pollution***  
Eliminate exposure of hazardous materials and chemicals to stormwater and provide proper containers for waste and garbage on site.

## 5.2 SWPPP CONTENT

A SWPPP is more than just an erosion prevention and sediment control plan. SWPPPs are dynamic site-specific written documents. They should be constantly updated and revised as site conditions change or as new conditions are identified. A SWPPP should contain and address the following:

### ✓ Site Description and Supporting Information (Narrative)

- A description of all construction activities at the site (not just grading and street construction): Estimated total area expected to be disturbed by excavation, grading, or other construction activities, including dedicated off-site borrow and fill areas; estimated project start and end dates. Project type or function (for example, low-density residential, shopping mall or highway)
- Sequence of major activities which disturb soils for major portions of the site (e.g., grubbing, excavation, grading, utilities and infrastructure installation, etc.);
- Estimated area of the site and the total area that is expected to be disturbed;
- Soil Data: how the soil type will dictate the needed control measures and the expected quality of any discharge from the site;
- Estimated runoff coefficient and curve numbers of the site after construction activities are completed and how the runoff will be handled to prevent erosion at the permanent outfall and receiving stream;
- A description of any discharge associated with industrial activity other than construction stormwater that originates on site and the location of that activity and its permit number;
- Identification of any stream or wetland on or adjacent to the project, a description of any anticipated alteration of these waters and the permit number or the tracking number of the Aquatic Resources Alteration Permit (ARAP) or Section 401 Certification issued for the alteration;
- The name of the receiving water(s), and approximate size and location of affected wetland acreage at the site;
- For projects that will have separate and common stormwater features, such as residential developments or industrial parks, the developer/owner must describe how he/she will prevent erosion and/or control any sediment from portions of the property that will be sold prior to completion of construction; once the property is sold, the new operator must obtain coverage under this CGP, and assume operational control and responsibility of that portion of the site;
- For projects of more than 50 acres, the construction phases must be described; however, phasing of all projects is highly recommended;
- If only a portion of the total acreage of the construction site is to be disturbed, then the protections employed to limit the disturbance must be discussed, i.e., caution fence, stream side buffer zones, etc.
- Pollution prevention measures for non-stormwater discharges
- Documentation of permit eligibility related to Total Maximum Daily Loads, TMDL.

- Summary of supporting calculations for the design of sediment basins, channel linings, inlet protection, outlet protection, etc. While it is not necessary to include every calculation performed, enough information should be included with the SWPPP to show that the proper design criteria were used.
- ✓ **Erosion Prevention and Sediment Control Plan**
  - Site development plan with the proposed construction area clearly outlined;
  - Boundaries of the permitted area;
  - Topographic information for the site and the adjacent properties (to determine run-on and watershed boundaries);
  - Approximate slopes anticipated after major grading activities;
  - Areas of soil disturbance, including an outline of areas which are not to be disturbed;
  - Location of major structural and nonstructural controls identified in the SWPPP;
  - Location of areas where stabilization practices are expected to occur;
  - Location and boundaries of buffer zones, if any, established to protect waters of the state located within the boundaries of the project;
  - Locations of surface waters including wetlands, sinkholes, and careful identification on the map of outfall points for stormwater discharges from the site;
  - Locations of other permit boundaries, such as ARAP, TVA 26A or COE permits, including locations of stream realignments or mitigation areas;
  - Locations of temporary and permanent stormwater management structures;
  - Locations of stockpile and/or borrow areas;
  - Separate sheets for staged plans to show detail. For projects greater than 5 acres, at least 3 staged plan sheets should be provided: the clearing and grubbing phase, initial grading plan with perimeter controls and the final grading plan with final EPSC and stormwater management controls in place;
  - Construction details with dimensions, cross sectional views and/or plan views with enough information for the contractor to understand how to install the practice.

### 5.2.1 Field Reconnaissance

The development of a site-specific SWPPP requires a great deal of information about a site. Much of the base information can be obtained from existing data sets, such as soil surveys, contours, and known stream locations. However, existing general data sets alone should not be the sole source of site information used to develop the SWPPP. Often times, these data sets are invalid due to recent development and may lead a designer to incorrect assumptions that can negatively affect components of a SWPPP. After collecting the existing base information, the designer should visit the site and perform a full site assessment prior to preparing the SWPPP.

### Site Assessment

The best place to start on the preparation of a SWPPP is in the field, at the site. While some pre-site visit information can and should be gathered to give a holistic understanding of the

site, this information coupled with a comprehensive site assessment provides the most complete picture of the site. The approximate locations of salient features should be identified during field reconnaissance and marked on a base map (USGS topographic map works well). Describe the undeveloped site and identify features of the land that can be incorporated into the final plan and natural resources that should be protected. Understanding the hydrologic and other natural features will aid in developing a better SWPPP and, ultimately, to more effectively prevent stormwater pollution. Too many SWPPPs have been prepared and submitted from an aerial photo and topographic map to save time and man hours. While it may appear that a desktop analysis is the most cost effective manner to produce a SWPPP, significantly more money and time may be necessary to revise a plan if a feature, such as a stream or sinkhole, is encountered after the SWPPP has been developed or construction begins.

The following items should be considered during the field reconnaissance:

#### **Site Suitability**

Developers and builders can minimize erosion, sedimentation, and other construction problems by selecting areas appropriate for the intended use. Tracts of land vary in suitability for development. Knowing the soil type, topography, natural landscape values, drainage patterns, flooding potential, and other pertinent data helps identify both beneficial features and potential problems of a site.

#### **Areas to protect.**

Sinkholes, streams, wetlands, critical habitat, steep slopes, and cemeteries are example features that should be avoided and protected on a project. Identifying these early in the project development process prevents costly changes to development plans. If streams or wetlands are to be impacted by the development, additional permits may be required, meaning additional permitting time should be added to your overall project development schedule.

#### **Drainage patterns.**

Understand the watersheds and subwatersheds around your project. Know if your site is located at the bottom of a watershed or at the top. Identify areas where run-on from adjacent properties could affect your project design. Identify springs, wet weather conveyances and streams early in your project to avoid potential problems as the project goes into construction.



### 5.2.2 Local Requirements

Local municipalities (cities and counties) may have their own requirements for construction sites that are more stringent than state requirements (e.g., local permits for grading or sediment and erosion control, utilities, etc.). Compliance with both state and local requirements is necessary. Check with your local jurisdiction early in the SWPPP preparation process to understand their requirements.

### 5.2.3 Staged Drawings

For all but the simplest sites, grades on a development will change substantially from the initial grading to the final grade. To address EPSC and stormwater management during each stage of construction, staged drawings should be provided. Staging is an important tool in managing EPSC on a project, and it is important that EPSC measures follow the flow of work through construction staging and phasing. For the purposes of this manual *staging* refers to the different construction stages, such as clearing and grubbing, initial or rough grading, and final grading. *Phasing*, on the other hand, references the day-to-day site management that balances disturbed, undisturbed and stabilized areas. Phasing on larger projects may be necessary to limit the overall disturbed area at any one time to less than 50 acres, as required by the CGP.

Design plans should also contain basic information such as a scale, north arrow, topographic information at a level of detail to understand flow patterns and slopes, limits of disturbance, drawing revision dates, and a location map. Construction details for each management practice should also be included.

Often times, one EPSC plan is developed based upon final grades, making the initial installation of measures infeasible and the ongoing construction site management difficult. The number and level of detail of EPSC plan drawings will vary dependent on the complexity of the design. However, at least 3 staged drawings will be needed:

1. The clearing and grubbing plan,
2. Interim grading plan and
3. The final grading plan.

The **initial clearing and grubbing plan** should show site contours with enough grading to install initial and perimeter measures. These measures may include a construction entrance, silt fence, sediment basins, diversions, etc. This plan simplifies the installation of the initial measures and steps the site operators through EPSC management on the site in a sequential manner.

For more complex sites with a substantial amount of earthwork, an **interim grading plan** may also be needed. Interim grading plans are necessary when contours on the site change between the clearing and grubbing stage and final grading stage to the extent that the proposed practices for those stages don't fit for an interim grading stage. Often, the interim grading plan and EPSC controls are modified as construction progresses. Note that anytime measures are changed, deleted, or added on an EPSC plan, the field plan (a component of the SWPPP document) should be updated. Each staged drawing should clearly show the area to be disturbed,

areas to be protected from construction activities, existing and proposed contours, and measures to be installed in that stage.

The **final grading plan** should show the final, finished contours and any permanent erosion and stormwater management controls. Permanent controls include permanent stream buffers, energy dissipaters, permanent stormwater detention basins, rip rap lined channels, etc.

#### 5.2.4 Construction Schedule

Construction sequencing requires creating and following a construction schedule that balances the timing of land disturbance activities and the installation of measures to control erosion and sedimentation, in order to reduce on-site erosion and off-site sedimentation. One of the primary focuses of the construction schedule should be to minimize the amount of disturbed area at the site at any one time. Limiting the area of disturbance and stabilizing areas as quickly as possible can be the most effective management practices and most cost-effective way of controlling erosion during construction.

Construction drawings should clearly state the designer's intentions, and an appropriate sequence of construction should be shown on the plans. This sequence should be discussed at the pre-construction meeting and then enforced by an appropriate inspection program throughout the construction period. While the pre-construction conference isn't required by the CGP, it is strongly encouraged and should include the on-site responsible construction personnel.

Appropriate parts of the SWPPP must be implemented before clearing, grubbing, grading, and excavating activities begins. After construction activities begin, the SWPPP should describe when additional erosion prevention and sediment controls will be installed (generally after initial clearing and grubbing activities are complete).

Each construction site should have a site specific construction schedule included with the SWPPP. However, initial activities in a construction sequence are often very similar. Table 5-1 contains some schedule considerations for typical construction activities. Note that when a construction site has other permits besides just the CGP, such as an ARAP, the construction sequence should include those activities and specific scheduling requirements as well.

**Table 5.2-1 Example Construction Schedule**

Construction Activity	Schedule Consideration
Installation of erosion prevention and sediment control, EPSC, measures	a) Perform selective vegetation removal for silt fence installation b) Install stabilized construction entrance c) Install silt fence and diversions d) Install high visibility fencing around areas not to be disturbed
Construction access, entrance to site, construction routes, areas designated for equipment parking	This is the first land-disturbing activity. As soon as construction begins, stabilize any bare areas with gravel and temporary vegetation.

Sediment traps and barriers, sediment basin, silt fences, outlet protection	After construction site is accessed, sediment basins should be installed, with the addition of more traps and barriers as needed during grading.
Roadbed and haul road stabilization and slope stabilization	To prevent overloading other measures, construction haul roads, roadbeds, and slopes should be stabilized either temporarily or permanently. Storm drain pipes associated with roadways should also be stabilized.
Runoff control, diversions, perimeter dikes, water bars, outlet protection	Key practices should be installed after the installation of sediment basins and traps and before land grading. Additional runoff control measures may be installed during grading.
Runoff conveyance system, stabilize stream banks, storm drains, channels, inlet and outlet protection, slope drains	If necessary, stabilize stream banks as soon as possible, and install principal runoff conveyance system with runoff control measures. The remainder of the systems may be installed after grading.
Land clearing and grading, site preparation (cutting, filling, and grading, sediment traps, barriers, diversions, drains, surface roughening)	Implement major clearing and grading after installation of principal sediment and key runoff-control measures, and install additional control measures as grading continues. Clear borrow and disposal areas as needed, and mark trees and buffer areas for preservation. Stockpile topsoil for use in final stabilization later.
Surface stabilization, temporary and permanent seeding, mulching, sodding, riprap	Temporary or permanent stabilizing measures should be applied immediately to any disturbed areas where work has been either completed or delayed. Temporarily stabilize topsoil stockpiles (seed stockpile and silt fence around toe of slope)
Building construction, buildings, utilities, paving	During construction, install any erosion and sediment control measures that are needed.
Landscaping and final stabilization, topsoiling, trees and shrubs, permanent seeding, mulching, sodding, riprap	This is the last construction phase. Stabilize all open areas, including borrow and spoil areas, and remove all temporary control measures. Stabilize disturbed areas associated with temporary measure removal.

### 5.2.5 Construction Details

The SWPPP must also include typical construction details with enough information to convey construction information to the site inspector and, more importantly, the contractor. Construction details can be cross sectional or plan views of the measure but need to show elevations, installation and type of materials for a measure. The details can be located on a separate detail sheet of the EPSC drawings or on sheets where each measure will be installed, depending on the site detail.

The details can be generic for some measures, such as silt fence or wattles but must show the correct sizes and installation. However, it is likely that a construction detail will be necessary for each complex measure, such as a sediment basin on a project to show the basin-specific materials and sizes. For example, each basin on a project may have different permanent pool elevations, riser pipe diameters and outlet geometry.

Note in Figure 5.2-1 below that two different typical construction details are given for EPSC measures used throughout the project. The silt fence detail gives enough information for a contractor to correctly install the measure, and the detail applies to silt fence installations specified throughout the project. The diversion berm detail, however, does not provide enough detail. Note the “maximum” and “minimum” notes on the cross sectional view. These values should be inserted specifically, as should the top width, height and stabilization method so the contractor can install the correctly dimensioned measures in the field.

Appendix F contains standard drawing details that can be incorporated into the design plans and customized for each site.

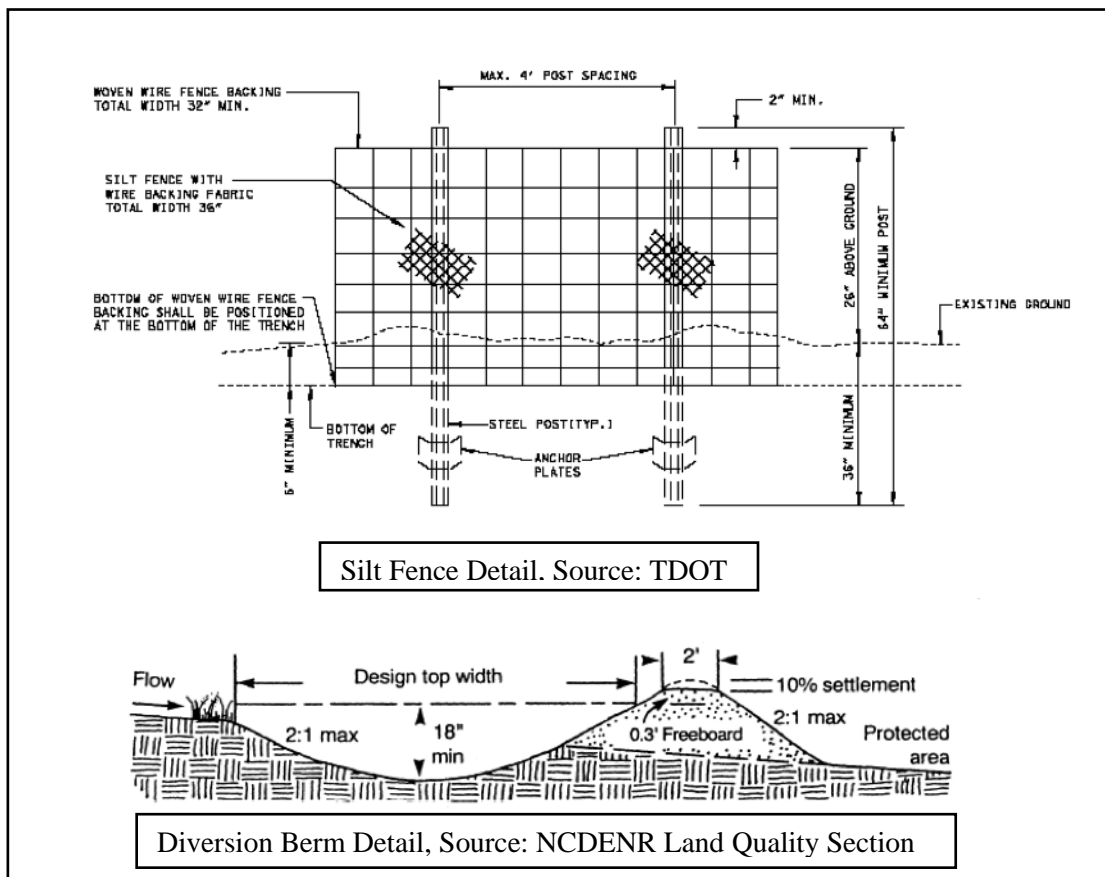

Figure 5.2-1 Typical Construction Detail



## 5.2.6 Other Considerations

### Impaired or Exceptional TN Waters

The CGP contains additional design related requirements for construction sites that discharge into streams that are either designated by TDEC as Exceptional Tennessee Waters or as impaired due to siltation (sediment). Erosion prevention and sediment control measures must be designed to control runoff generated by the 5-yr, 24-hr storm event. Also, sediment basins (or equivalent measures) are required for outfalls that have a total drainage area of 5 acres or more. The basin must be designed to provide treatment for the volume of runoff from a 5-yr, 24-hr storm event from each acre drained.

### Buffer Zones for Impaired or Exceptional TN Waters NOTE:

For sites that contain and/or are adjacent to a receiving stream designated as impaired or Exceptional Tennessee waters a 60-foot natural riparian buffer zone adjacent to the receiving stream shall be preserved, to the maximum extent practicable, during construction activities at the site. The natural buffer zone should be established between the top of stream bank and the disturbed construction area. The 60-foot criterion for the width of the buffer zone can be established on an average width basis at a project, as long as the minimum width of the buffer zone is more than 30 feet at any measured location.

A 30-foot natural riparian buffer zone adjacent to all streams at the construction site shall be preserved, to the maximum extent practicable, during construction activities at the site. The riparian buffer zone should be preserved between the top of stream bank and the disturbed construction area. The 30-foot criterion for the width of the buffer zone can be established on an average width basis at a project, as long as the minimum width of the buffer zone is more than 15 feet at any measured location.

### Total Maximum Daily Loads (TMDL)

The SWPPP must include documentation addressing an approved TMDL for a pollutant of concern, including:

- a) identification of whether the discharge is identified in an approved TMDL and any associated allocations, requirements, and assumptions identified for the discharge;
- b) summaries of consultation with the TDEC-WPC on consistency of SWPPP conditions with the approved TMDL, and
- c) measures taken to ensure that the discharge of pollutants from the site is consistent with the approved TMDL, including any specific waste load allocation that has been established that would apply to the discharge.

### Pollution Prevention Principles for Good Housekeeping

Besides sediment, the SWPPP must address other potential stormwater pollutants on the construction site. It must include a description of construction and waste materials expected to be stored on-site and include a description of controls used to reduce pollutants from those materials, including storage practices to minimize exposure of the materials to stormwater, and spill prevention and response.

The principles described below are designed to aid in identifying pollution prevention practices that should be described in the SWPPP and implemented on site.

**1. Provide for waste management.**

Practices such as trash disposal, recycling, proper material handling, and cleanup measures can reduce the potential for construction site waste materials from becoming stormwater pollutants. Keep dumpsters covered to prevent trash from being blown out and into the stormwater system. For larger, solid construction debris, an open containment system (as simple as a wire fenced in area) can provide enough protection from materials moving around the construction site and into the storm drain system.

**2. Establish proper construction materials staging area(s).**

The SWPPP should include comprehensive handling and management procedures for construction related materials, especially those that are hazardous or toxic. Paints, solvents, pesticides, fuels and oils, other hazardous materials or any building materials that have the potential to contaminate stormwater should be stored inside the construction trailer, in a storage building, or under cover whenever possible. If such a scenario isn't feasible on the construction site, secondary containment should be provided. Secondary containment systems provide a means to capture spills and prevent them from moving offsite in stormwater runoff. More information on secondary containment systems can be found in Section 7.19. Training employees and subcontractors on materials storage and spill prevention is essential to the success of this pollution prevention principle.

**3. Designate concrete washout areas.**

Designate specific on-site washout areas and design facilities to handle the anticipated volume of concrete washout. The washout area should be clearly marked, and operators and contractors made aware of its location. Once the concrete washout slurry sets up, the material can be broken up and removed or used where allowed as suitable fill material. In slurry form, concrete washout can impact a receiving stream or watercourse in numerous ways, including covering habitat, clogging fish gills, and altering the pH of the water .

**4. Establish proper equipment/vehicle fueling and maintenance practices**

Performing equipment/vehicle fueling and maintenance at an off-site facility is preferred over performing these activities on the site. However, on some projects, onsite vehicle maintenance may be necessary. The goal of this pollution prevention principle is to keep fuel, oils and greases from coming into contact with stormwater. Create an on-site fueling and maintenance area that is clean and dry, equipped with a spill kit, and staff should be trained in how to properly use it. Maintenance and refueling stations should be established well away from streams, wetlands and storm drain systems. Drip pans should be installed under any leaky equipment. Any material in the drip pans should be collected and taken offsite for proper disposal. Lubricants, solvents and fuels should be stored under cover or have secondary containment systems installed to prevent spills or leaks from mixing with stormwater.

**5. Develop a spill prevention and response plan**

A comprehensive spill prevention and response plan is needed where any fluids are stored on a construction project. The plan should clearly identify the site contact for spills; identify ways to reduce the chance of spills; identify methods to stop the source of spills; describe

how to contain and clean up spills; identify the location of the closest stormwater system component, stream or wetland; describe the disposal method for materials contaminated by spills; and provide a mechanism to train personnel responsible for spill prevention and response. Chapter 7 contains additional information on spill prevention and response.

### **Endangered or Threatened Species**

A determination should be made if listed endangered or threatened species or their critical habitats are located on or near the construction activities. A description of measures taken to avoid disturbance should be listed. Contact local offices of the U.S. Fish and Wildlife Service (FWS) and TDEC Division of Natural Areas for listings of protected species and habitats.

### **Permanent Stormwater Management**

While the CGP's primary focus is on construction related stormwater management activities, construction is typically the initial step towards a built-out environment, where permanent stormwater management controls are included and incorporated into the overall development plan. These permanent controls are designed to reduce stormwater discharges to a non-erosive velocity, reduce runoff volumes to prevent degradation of receiving stream channels, and reduce pollutants in stormwater runoff quality to prevent degradation of receiving streams. Integrating these permanent controls into the development plans in the SWPPP manages the site and its resources more comprehensively.

The CGP includes a general requirement to manage stormwater runoff after development. The SWPPP must include a description of measures that will be installed during the construction process to control pollutants in stormwater discharges that will occur **during and after** construction operations have been completed such as practices that control pollutants and any increase in the quantity of stormwater discharges that will occur after construction operations have been completed. The planning and citing of permanent stormwater controls can affect decisions concerning site design, location of buildings and other structures, grading, and preserving natural features.

Low impact development techniques (see Chapter 6) that emphasize reducing the generation of stormwater runoff, preserving natural drainage patterns, and preserving natural vegetation offer the best opportunities to protect a site's natural resources as well as nearby streams, rivers, lakes, and wetlands. Incorporating these ideas and concepts into the design and planning for a project before it is built can also translate to reduced capital infrastructure and long-term maintenance costs.

In addition to the requirements contained in the CGP, local jurisdictions may also have permanent stormwater management requirements. Prior to preparing the SWPPP, the designer should contact the local jurisdiction for guidance on their stormwater program requirements. Understanding their requirements early in the planning and design process can avoid costly redesigns and schedule adjustments. Note that both the state and local stormwater management requirements must be met.

### Special Site Conditions

Many difficult site conditions can occur at a construction site. Some of the more common and problematic conditions are highlighted below.

- 1. Steep slope areas.** Development in mountainous areas requires specific attention to stormwater runoff management, both during and after construction. During the SWPPP development, techniques to reduce flow length and velocities must be incorporated into the SWPPP, such as ditch turnouts with outlet protection, frequent diversions, check dams, and slope drains. Roadway layout should strive for longer roadways with flatter grades and many ditch turnouts. Fill slopes should be 3:1 or flatter and incorporate slope breaks. Stabilization of diversions and channels should be a priority.
- 2. Sensitive streams.** Development near streams must incorporate stream buffers. However, additional consideration should be given to these sites for short-term and long-term stormwater management, including buffer enhancement where the existing buffer does not have adequate woody vegetation; a site layout that incorporates limited stream crossings; wider buffers where adjacent slopes are steep; and the incorporation of level spreaders to convert concentrated flow to sheet flow prior to discharging into the stream buffer.
- 3. Difficult soils.** When developing the SWPPP, the soils on the project should be determined.
  - If the potential exists for your site to have difficult soils, additional measures may be necessary to ensure successful implementation of the SWPPP at the site. For clayey soils, include provisions in the SWPPP for passive or active treatment for turbidity. While clay soils are less erosive, once eroded and in the stormwater column, settling is very difficult. Flocculants may be necessary to reduce the turbidity of the discharge.
  - If the potential exists at your site for highly acidic soils such as pyritic soil formations, include provisions for managing acid runoff. These provisions can include capping onsite, treatment onsite or disposing the soils properly offsite.
  - If your site has non-cohesive soils, refined stabilization techniques should be incorporated into the SWPPP. Non-cohesive soils may require very flat slopes and low velocities. RECPs that are pinned in place may require specialty pins or anchors that go deeper than regular pins. For steep fill slopes, a geotechnical engineer may be required for the design.
- 4. Active and passive treatment systems.** To meet effluent limitations, construction sites may be required to include either passive or active treatment systems to manage turbidity in their discharge. The designer must include design components such as the treatment type, soil type and discharge polishing. Many of these treatment components require a settling area, a treatment delivery mechanism, and a method to repair or maintain each component.
- 5. Rock outcrops.** Many areas in Tennessee have bedrock either exposed or very close to the surface. Shallow bedrock can cause difficulties on a construction project, as it deters infiltration and impacts the measures that can be installed to manage runoff. However, soil erosion is typically minimized where the majority of the site surface is rock. Particular attention should be given to sediment control. Many common BMPs cannot be constructed. For example, silt fence cannot be trenched in at the toe. Wattles and other controls that need minimal site preparation should be included in the SWPPP for sites with shallow bedrock. Stabilization techniques, such as bonded fiber matrix, may also be necessary to get vegetation established on rocky slopes.



- 6. Sinkholes.** Where sinkholes are known or suspected, the SWPPP should identify them and protect them from sediment laden runoff. Where the throat of the sinkhole is open, mulch should not be used in the sinkhole basin, as clogging of the sinkhole and flooding may occur. Stormwater runoff should be treated before discharging into the sinkhole. A Class-V Injection Well permit may be needed when the sinkhole drainage is improved.

### **5.3 MANAGING THE SWPPP**

The SWPPP is a dynamic document that manages EPSC and stormwater runoff throughout the life of the construction activity. Typically, field conditions change once construction starts due to unforeseen site conditions such as the location of utilities, soils, and/or other materials encountered on the project. While a thorough site analysis during SWPPP development and preparation limits the level of unforeseen conditions that may affect construction, it is likely that construction schedules and stormwater management needs will change as the project progresses. For this reason, the SWPPP must be updated to reflect site conditions. This section provides background on how a site operator should manage his SWPPP.

#### **5.3.1 Multiple operators, new operators, termination of operators**

Multiple operators may operate under the same SWPPP, but responsibilities must be clearly described. There is always a primary permit holder for each permit, while there can be several secondary permit holders, depending on how work is being completed on the project. However, depending on the type of development, there may be several permits with primary holders. Preparation and implementation of the SWPPP may be a cooperative effort between more than one operator at a site. Other primary permittees at the site may develop a SWPPP addressing only their portion of the project, as long as the management practices are compatible with the comprehensive SWPPP and comply with conditions of the general permit. New operators with design and operational control over their portion of the construction site are not precluded from developing and implementing their own SWPPP, but are encouraged to adopt, modify, update, and implement a comprehensive SWPPP. Separate SWPPPs cannot cause a conflict with a comprehensive SWPPP in the same development.

When new operators are added to a SWPPP, a supplemental NOI should be completed and submitted to the TDEC field office at least 2 days prior to the new operator taking operational control over any portion of the site. When a contractor (a secondary permittee) is no longer a contractor on a site covered by the CGP, he can request termination of his coverage through the NOT.

Permits can be reassigned if the original operator is no longer involved with the development and the new operator agrees to accept the responsibility of the permit.

#### **5.3.2 Onsite records management**

A copy of the SWPPP must be maintained on the site at all times; a copy of the NOC must be posted on site in a location visible to the public. (Note: if this is not possible, contact your local TDEC field office and discuss alternatives). If a construction trailer is onsite, keep the SWPPP documents in the trailer in a designated location. If there is no construction trailer, a SWPPP box should be constructed for the SWPPP document to be stored. The location of the SWPPP should be clearly identified in the original SWPPP submitted for coverage under the CGP. If the site is

inactive or does not have an onsite location adequate to store the SWPPP, the location of it, along with a contact phone number, shall be posted on the project. If the SWPPP is located offsite, reasonable local access to the plan, during normal working hours, must be provided. Updated plans and inspection reports must be available upon request by inspectors, local agency approving EPSC plans, grading plans, or stormwater management plans, or the operator of the local MS4.

Besides the original SWPPP documents submitted for coverage under the CGP, additional information is needed to manage the construction site and SWPPP.

**Inspection reports.** Routine inspections are required by the CGP. Copies of the written reports must be kept with the SWPPP and provide enough information that a regulator is given a full picture of the management techniques employed onsite, including problems, maintenance needs, and corrective actions taken. The inspection report becomes a document of a site's compliance with the CGP. These reports need to clearly note the dates that problems or maintenance needs were identified and the dates that these activities were addressed, as well as dates when major grading activities occurred, the dates when construction activities temporarily or permanently ceased on a portion of the site, and the dates when stabilization measures were initiated. An inspection report form can be found in Appendix B.

**Rainfall data.** A rainfall gauge is required on the construction site and should be read at least once a day at approximately the same time to get a 24 hour rainfall depth total. In addition, when a rain event occurs, the approximate beginning and ending time should be documented to provide the rain event duration. The rainfall depth and duration together can be used to determine the storm frequency and related back to the permit and design requirements. Rainfall data should be kept with the field SWPPP.

**EPSC plan revisions.** The original EPSC plans submitted for coverage under the CGP will likely need to be updated and/or revised at various times throughout the life of the project. A set of EPSC plans should be designated as the "field plans" and used to show modifications and updates, which can be hand-written on the sheets. For major revisions or updates requiring engineering (such as hydrologic or hydraulic design modification or substantial site grade changes), an engineer may need to reissue a set of drawings. In any event, modifications should be noted to keep the SWPPP current and the date that the modification was implemented in the field should also be noted. These field plans should be available for state and local regulators to view and should reflect current site conditions.

**Rainfall records.** The CGP requires at least one rain gauge for monitoring rainfall on a project. For consistency, it is recommended that the rain gauge is read at the same time each day. Rainfall should be recorded in a rainfall log, and rainfall log kept with the onsite SWPPP. These records document the amount of rain a project has received (whether the rain was above or below the design standard for a measure).

## **6.0 INTEGRATING POST CONSTRUCTION REQUIREMENTS DURING CONSTRUCTION**

### **6.1 Low Impact Development Principles**

Low impact development, LID, is a site development management practice approach to managing storm water, addressing water where it falls: infiltrating it, preserving natural drainage patterns, and natural vegetation. These practices offer an opportunity to protect nearby streams, rivers, lakes, and wetlands. Practices, such as infiltration/bioretention basins and vegetated swales, are designed to mimic the predevelopment hydrological conditions through runoff volume control, maintaining base flows, peak runoff rate and water quality control. LID measures can result in less disturbance of the development area, conservation of natural features and can be less cost intensive than traditional control mechanisms. Cost savings are not only for construction but also for long term post construction maintenance and life cycle cost consideration.

#### **Ten common LID practices**

1. Rain Gardens and Bioretention
2. Infiltration trenches
3. Created wetlands
4. Vegetated Swales
5. Roof Drain Disconnection
6. Permeable Pavers
7. Soil Amendments
8. Sand filters

### **6.2 How to manage construction without impacting your post construction practices**

Installing LID Management Practices such as bioretention areas and infiltration swales, prior to construction site stabilization, may result in failure of the measures due to sedimentation and/or compaction. Timing their installation (pre-planning) is important to protecting these practices and avoiding sometimes extensive post-construction rehabilitation or complete re-installation. Infiltration practices depend on quality of soils and their porosity. These practices depend on soil mixtures, types, and pH. A standard functional bioretention facility should have sand, loam and compost mixture. No other materials or substance should be mixed in it that may be harmful to plant growth or prove a hindrance to planting or maintenance to operations. The planting soil must be free of plant or seed material of non-native invasive species or noxious weeds. Sediment run-on from disturbed areas can clog practices and change the soils composition and pH. Also, compaction due to construction disturbance can also impact their effectiveness and result in the necessity of spending more resources to restore their functionality.

### **Construction Staging**

To ensure the greatest potential of success of a LID facility, practices should not be installed until construction activity is completed and stabilized within the entire contributing drainage area; this means having all areas both fully landscaped and mulched or having well established grass or other ground cover. Construction drawings should clearly state the designer's intentions and an appropriate stage of construction should be shown on the plans. This staging should be covered in detail at the pre-construction meeting (including the on-site responsible construction personnel) and then enforced by an appropriate inspection program throughout the construction period. On-site education of contractor and/or subcontractors would also be advised. Storing and reestablishing top soil on site is important to reestablishing the overall infiltration of the site.

Each site is unique, and this strict construction staging approach may not be necessary, such as in the case of bioretention in parking lot islands with little contributing pervious areas. It is critical that the designer understands these realities and plans accordingly.

### **Erosion prevention and sediment controls**

Erosion prevention and sediment control plans (EPSC) should be developed at the same time as the permanent stormwater management plan concept with an eye for potential hot spots; these potential trouble areas should have redundant practices installed in an effort to protect the LID facility from unusually extreme or long duration storm events that could inundate the protection. An enforceable inspection program is a critical component of this approach as well. In the event that a breach of the protection practices occurs that results in adverse impact of the facility, mandatory reconstruction of the facility should be enforceable, if needed.

Site control practices are grouped into two categories: temporary practices during construction and permanent practices for permanent stormwater management runoff control. Practices that are installed for the construction phase that are meant to persist and become post-construction management practices such as sediment basins and vegetative swales depend on specific design parameters such as:

- Soil type, pH, and permeability
- Practice volume and freeboard
- Infiltration
- Open space

### **Temporary Flow Control**

If the decision is made to construct a LID facility, such as a retention/infiltration area or constructed wetland, in conjunction with the overall site the drainage from up-gradient disturbed areas should be diverted around the facility. The diversion must remain in place until all disturbed areas contributing to the facility are stabilized. The diversion must employ sediment control devices such as earth dikes, diversion swales, etc. as soon as possible before construction begins. Depending on the soil type, the diversion channel may require some type of surface protection to prevent erosion of the channel surface. Diversion channels must be designed with a cross section sufficiently large to carry the required design storm. Even in this case, sequencing should be established to delay the facilities' construction as long as possible and timed to minimize the potential of sedimentation.



**Permanent Control**

Detention and sediment ponds installed initially during construction and to be used for post-construction management as well. In those instances, the ponds must be cleaned out with pertinent elevations and storage and treatment capacities reestablished as noted in the approved storm water management plan. The final as-built certification must verify that final elevations and volumes are established per plans. The principal and emergency spillways should also be verified to meet permanent stormwater management plan parameters. Reduction of erosion and sediment draining to them can reduce the time and effort to maintain these practices and establish their post-construction functions. Many municipalities will not release construction bonds without approved as-builts.

**Undisturbed Areas**

Open space/undisturbed areas which have been set aside for post construction amenities should be identified on the plans, fenced off from any construction traffic, protected from sedimentation run-on and addressed specifically in pre-construction meetings. Disturbance and compaction of these areas can impact their functions and can result in costly rehabilitation and potential notice of violation and penalties. Extensive disturbance and compaction of these areas could result in redesign of site and of the storm water treatment train. Again continuous education of contractors and subcontractors by the permit holder or the inspector is vital.

**Minimize impact area**

Minimize the adverse impacts of the development on water quality and the hydrologic site conditions by avoiding construction or land disturbance in the most sensitive areas. These would include steep slopes, wooded areas, erodible soils, natural drainage ways, and stream buffers to name a few. These areas should be clearly delineated on the plan sheets and in the field and contractors and subcontractors should be educated on avoidance of these areas. By realizing that site development is a dynamic process, the site designer is challenged to choose an erosion sediment and management strategy that will accommodate the changing landscape of the site during phases of construction.

## **7.0 MANAGEMENT PRACTICES**

Chapter 7 contains design information and guidance for each management practice. The purpose of this section is to provide the design professional preparing the Stormwater Pollution Prevention Plan (SWPPP) and Erosion Prevention and Sediment Control (EPSC) Plan with detailed design and implementation guidelines for each management practice and to provide the inspector with installation and maintenance information. This information is intended to minimize the time required to design each management practice under general site conditions, but it is not intended to apply to all sites and all applications. Unusual site conditions may dictate that management practices be designed as a special case with corresponding construction specifications written specifically for the special case. In most cases, these management practices should be designed as a comprehensive system of controls rather than stand alone devices.

Each management practice presented herein contains a stated definition, purpose, application, additional considerations, design criteria, construction specifications, and maintenance and inspection information. Additional information and design examples may be found in the Appendices.

## 7.1 IDENTIFYING SENSITIVE AREAS OR CRITICAL AREAS



- Definition** Marking, flagging, or fencing areas in the field that should be protected from construction activities such as clearing, grading, mowing, staging activities, materials storage, and/or other related activities.
- Purpose** To protect sensitive areas from being disturbed or encroached upon by construction or construction-related activities.
- Conditions Where Practice Applies** Any site containing features considered to be sensitive to the impacts from construction, regardless of the project size. Areas that should be protected include tree preservation areas, Aquatic Resources Alteration Permit (ARAP) boundaries, streams, wetlands, endangered or protected species habitat, water quality buffers, mitigation or stream relocation boundaries, sinkholes, stormwater treatment areas, caves, and historic preservation areas. There may also be special cases in which the land owner or design professionals deem an area critical for preservation that should be clearly marked to prevent disturbance.
- Planning Considerations** Any sensitive or critical areas within the project boundaries should be identified in the SWPPP and on the EPSC plans. The design professional should clearly label all areas on construction plans and specify the type of marking materials to be used.
- Design Criteria** When a construction project contains wetlands or streams, additional permits are typically required (see Section 2 for more information on other permits that may be needed). Before any construction activity begins on a project in the vicinity of streams and wetlands, all permit boundaries should be identified on the project and marked in the field.
- Temporary and permanent water quality buffers should also be identified. Maintenance and disturbance restrictions can vary, depending on the regulatory

agency's requirements. For example, some portions of buffers can be disturbed and revegetated, while other buffers must remain completely undisturbed. Before staking the outer limits of the buffer, understand the local and state requirements relative to temporary and permanent water quality buffer zone disturbance and long term vegetation management. The SWPPP must clearly document these for the site.

In addition to streams and wetlands, other sensitive areas should be protected during construction. Any portions of the development that are designed as undisturbed natural areas should be clearly marked in the field to prevent disturbance. If these areas are disturbed, additional site design components may be needed to meet local or state requirements.

Areas that should be identified and clearly marked as sensitive areas in the field include the following:

- **Streams and wetland buffers.** Note that the buffer requirements in the Construction General Permit (See Appendix A) may not be the same as the locally required stream and wetland buffers. The more restrictive of the two must be followed.
- **ARAP boundaries.** If the ARAP allows a specific footage or acreage of stream or wetland encroachment, going beyond these boundaries can result in a violation. Clearly marking these boundaries in the field aids in maintaining compliance with the ARAP conditions.
- **Stream mitigation or relocation boundaries.** It is likely that a two step field marking process is necessary for stream relocations and/or mitigation. The first boundaries should identify the permitted impacts to the natural resource and should occur prior to work in the area. Once the relocation or mitigation has been installed and stabilized, these areas should be marked to show the outer limits and prevent disturbance or damage to plants.
- **Sinkholes.** Depending on the drainage patterns of the site, the only discharge point from a site may be a sinkhole. Sinkholes are a vital component of the drainage network and are subject to clogging by sediment and debris. Sinkhole basins should be protected from sediment from construction sites by using appropriate erosion prevention and sediment controls upgradient from the basin. Leaving sinkhole basins undisturbed provides an additional measure of protection. It should be noted that discharges to sinkholes may require a underground injection well permit from the TDEC Division of Water Supply.
- **Undisturbed areas.** Often, undisturbed open space requirements are established and enforced by the local jurisdiction. The amount of undisturbed open space per development is typically a percentage of the development. Disturbing these areas can lead to additional development restrictions or mitigation requirements. In addition, undisturbed areas of a site affect sediment control design. The less disturbed area on a site, the smaller the sediment storage required. If an area is shown on the SWPPP as undisturbed and is disturbed during construction, the sediment control measures can easily be overwhelmed, causing a failure and potential violation.
- **Threatened and/or Endangered species habitat.** Critical habitat for threatened or endangered species should be protected from land disturbing activities and



to avoid a potential “taking.” These areas should be clearly identified on the plans and in the field to prevent inadvertent disturbance or encroachment.

- **Stormwater management areas.** Land disturbing activities destroy the infiltration capacity of soils by changing the soil structure, compacting the soils, and subjecting soil organic matter to a more rapid decay process. Many stormwater management practices, such as bioretention areas and water quality swales rely on the soil infiltration capacity. When the infiltration capacity of the in situ soils is substantially altered, the area may no longer be suitable for permanent stormwater management controls.

### **Construction Specifications**

Many types of boundary markers are available. Flags, stakes, posts or fencing can be used as field boundary markers. Whatever type is used, it should be highly visible and installed along the outer perimeter of the feature’s boundaries. Bright colors and highly distinguishable marking materials should be specified, such as orange fencing, neon or brightly colored flags, or highly visible signage. Some markers will be temporary (such as ARAP permit boundaries) while others may be more permanent (such as permanent water quality buffer boundaries). The decision about the type of marker to be used at the site may in part be dictated by the lifespan of the feature being marked.

### **Maintenance and Inspection Points**

- Boundary markers should be maintained throughout the lifespan for the feature.
- Boundary markers should be inspected during each inspection, with inspections being performed as required by the CGP.
- Any markers that have been damaged, removed or degraded to the point that they are no longer visible should be replaced.
- Boundary markers should be removed at the end of construction, unless required by an agency or local government to be left in place.

### **References**

*TDOT Manual for Management of Stormwater Discharges Associated with Construction Activities*

*North Carolina Erosion and Sediment Control Planning and Design Manual*

## 7.2 CONSTRUCTION SEQUENCING



**Definition** A work schedule specific to each project that coordinates the timing of land disturbing activities, installation of erosion prevention and sediment control measures, permanent stormwater management controls and stabilization.

**Purpose** To minimize the erosion and sedimentation by performing land disturbing activities, installing EPSC measures, installing permanent stormwater controls and stabilization in accordance with a planned schedule. Note that phasing is a site management technique within an overall construction schedule, but should not be mistaken for the construction schedule itself.

**Conditions Where Practice Applies** All construction sites disturbing one or more acres are required to have a construction schedule in their SWPPP. However, sites that affect less than one acre can benefit from a planned construction schedule as well.

**Design Criteria** The construction sequence should be designed and written so that it is easily understood and followed by contractors and subcontractors. The sequence should clearly state the order in which erosion prevention and sediment control devices are to be installed, including stating what measures should be in place before other activities are begun. See Table 5.2-1 in Chapter 5 for an example construction sequence.

An example of construction sequencing could be as follows:

- Install Construction entrance, mark sensitive areas, and designate equipment and chemical storage areas.
- Install sediment basins and traps, silt fencing, and other sediment barriers for Phase 1.
- Install runoff controls such as diversion structures, silt fence, wattles, and outlet protection for Phase 1.
- Perform land clearing and grading, installing EPSC components at the earliest possible time during grading activities for Phase 1. Maintain EPSC measures throughout the grading process.
- Stabilize surfaces immediately in areas where work is delayed or completed.
- Mark sensitive areas and install perimeter measures for Phase 2.
- Clear and grub Phase 2.
- Install sediment traps and other internal controls. Maintain controls.
- Install permanent stabilization measures in Phases 1 and 2, such as seeding and mulching, sodding, and riprap at earliest possible time following completion of grading and construction activities.
- Remove temporary controls and stabilize all disturbed areas.

As in the CGP, project sites exceeding 50 acres of disturbance require phasing. In some cases individual construction sequences may be provided for each individual planned phase, while in other cases the designer may find it necessary to provide an overall construction sequence which interconnects the phases and encompasses the project as a whole.

**Construction Specifications**

The construction sequence is a part of the SWPPP and therefore shall be maintained onsite and be available to all contractors and subcontractors at all times. Efforts to adhere to construction sequence should be a coordinated effort between all parties onsite.

**Maintenance and Inspection Points**

Follow the construction sequence throughout the entire project development. When changes in construction activities are needed, amend the sequence schedule in advance to maintain management control.

**References**

*North Carolina Erosion and Sediment Control Planning and Design Manual*  
*TDOT Design Division Drainage Manual*

### 7.3 TOPSOILING



**Definition** The act of scraping topsoil from a construction site and reserving it for use to aid final stabilization.

**Purpose** To provide a suitable soil medium to support vegetation growth.

**Conditions Where Practice Applies** Topsoiling should be utilized on all construction sites where topsoil is available at the surface of the soil. Preserving topsoil for use at final stabilization ensures a healthy stand of vegetation. Topsoil storage areas should have EPSC measures applied, such as stockpile perimeter controls and temporary cover. Topsoil should only be placed on slopes less than 2:1 unless additional engineered slope stabilization is applied to prevent slippage.

**Planning Considerations** Topsoil is the major zone of root development and biological activity. It is generally darker than the subsoils due to enrichment with organic matter, but not all darker soils are topsoils. Questionable soils available for topsoiling should be analyzed by a soils specialist or soil scientist to insure that the soils can in fact support vegetation growth.

Although topsoil may improve growth capabilities for vegetation, there are some disadvantages to topsoiling. Stripping, stockpiling, hauling, and spreading topsoil, or importing topsoil, may not be cost-effective for some projects. In addition, some topsoil contains weed seeds which compete with desirable vegetation species.



In planning for the final grading and vegetation of a site, the designer should compare the options of topsoiling with preparing a seedbed in the available subsoils.

Subgrade elevations and finished grade elevations should be considered when planning for topsoil thickness.

Topsoil stockpiling should be conducted early in the project as large disturbed areas are scheduled. Placement of topsoil should be completed at the end of construction just before permanent vegetation is to be installed.

**Design Criteria** Topsoil should be stripped and stockpiled onsite before grading activities are commenced in any new area of the site. Stockpiled topsoil should be stabilized utilizing temporary vegetation practices (*refer to Sections 7.8 and 7.10 for more information*). Include a topsoil stockpile area on the EPSC Plan and in the construction sequence. Stockpile areas should be located where topsoil is less likely to discharge into streams and other sensitive areas if measures failed; where it does not block natural or artificial drainage ways; and where it does not interfere with work on the site.

**Construction Specifications** The topsoil stockpile must be protected against erosion. Stabilize the stockpile with a temporary or permanent groundcover. In addition, perimeter measures should be provided around the stockpile area to prevent sediment migration.

Once grading on any portion of the site has reached final grade, topsoil should be spread prior to final stabilization. Topsoil placement should not be specified in areas where slopes are steeper than 2:1.

Good quality topsoil has the following characteristics:

**General Characteristics** – Topsoil should be friable and loamy, free of debris, objectionable weeds and stones, and contain no toxic substances that may be harmful to plant growth. Topsoil should be handled only when it is dry enough to work without damaging the soil structure.

**Texture** – Loam, sandy loam, and silt loam are best; sandy clay loam, silty clay loam, clay loam, and loamy sand are fair. Heavy clay and organics such as peat or muck should not be used as topsoil.

**Organic Matter Content** – Organic materials should be greater than 2% by weight.

**Fertility and nutrients** – pH range should be 5.5 to 7.0; liming may be specified if pH is less than 5.5. Soil test for nutrients as well, based upon the type of vegetation to be established.

Organic and inorganic soil amendments (see Chapter 7) may be applied to topsoil to achieve the desired characteristics.

The depth of topsoil to be applied should be 5 inches (unsettled).

### **STRIPPING**

Strip topsoil only from areas that will be disturbed by excavation, filling, paving, or compaction by equipment. Stripping depth varies and should be site-specific.

### **STOCKPILING**

Topsoil stockpiles should be located to avoid slopes, natural and artificial drainage ways, and construction traffic. Multiple stockpiles near areas to be stripped may be specified on large sites so that re-spreading topsoil is more efficient and economical.

Sediment controls should be specified where necessary around stockpiles to prevent eroded topsoils from leaving the stockpile area. Temporary seeding practices should be performed no more than 15 days after the formation of the stockpile. Permanent groundcovers should be considered where topsoil stockpiles are to be inactive for longer periods of time.

### **TOPSOIL SPREADING**

Topsoil should be spread only when grading activities have been completed and permanent vegetation is to be applied. Grades should be maintained according to the approved plan, and final grades should not be altered by adding topsoil. The subgrade surface should be roughened by disking or scarifying to a minimum depth of 4 inches prior to spreading topsoil to ensure bonding of the topsoil and subsoils. Apply lime or fertilizer to subgrade before roughening.

Topsoil should be uniformly distributed to a minimum depth of 5 inches and compacted. Do not spread topsoil while it is excessively wet or frozen. Uniformly moisten excessively dry soil that is not workable or too dusty. Correct any irregularities in the surface to prevent the formation of depressions or water pockets. After topsoil application, follow procedures for permanent vegetation.

### **Maintenance and Inspection Points**

Topsoiled areas should be inspected for erosion, depressions or ridges, rocks, and other foreign materials prior to beginning permanent vegetation applications. These areas are subject to ongoing inspections and maintenance until final permanent stabilization has been achieved and a Notice of Termination has been submitted.

### **References**

*TDOT Design Division Drainage Manual*

*North Carolina Erosion and Sediment Control Planning and Design Manual*

*AIA Masterspec 95 Format, section 02920*

## 7.4 TREE PRESERVATION



**Definition** Practices to preserve and protect desirable trees from damage during construction activities.

**Purpose** To preserve and protect trees that have present or future value for environmental or aesthetic benefits.

**Conditions Where Practice Applies** On construction sites to be developed or disturbed that contain desirable existing trees.

**Planning Considerations** Preserving and protecting trees and other natural plant groups often results in a more stable and aesthetically pleasing development. During the site evaluation, note where valuable trees and other natural landscape features should be preserved, then consider these trees and plants when determining the location of roads, buildings, or other structures.

Trees that are near construction zones should either be protected or removed because damage during construction activities may cause the death of the tree at a later time.

Trees should be considered for preservation for the following benefits:

- They stabilize the soil and prevent erosion.
- They moderate temperature changes, promote shade, and reduce the force of wind.

- They provide buffers and screens against noise and visual disturbance, providing a degree of privacy.
- They filter pollutants from the air, remove carbon dioxide from the air, and produce oxygen.
- They provide a habitat for animals and birds.
- They increase property values and improve site aesthetics.

Consider the following characteristics when selecting trees to be protected and saved:

- **Tree vigor** – Preserve healthy trees. A tree of low vigor is susceptible to damage by environmental changes that occur during site development. Healthy trees are less susceptible to insects and disease. Indications of poor vigor include dead tips of branches, small annual twig growth, stunted leaf size, sparse foliage, and pale foliage. Hollow or rotten trees, cracked, split or leaning trees, or trees with broken tips have less chance for survival.
- **Tree age** – Old, picturesque trees may be more aesthetically valuable than smaller, younger trees, but they may require more extensive protection.
- **Tree species** – Preserve those species that are the most suitable for site conditions and landscape design. Trees that are short-lived or brittle or are susceptible to attack by insects and disease may be poor choices for preservation.
- **Tree aesthetics** – Choose trees that are aesthetically pleasing, shapely, large, and colorful. Avoid trees that are leaner and in danger of falling. Occasionally, an odd-shaped tree or one of unusual form may add interest to the landscape if strategically located. However, be sure the tree is healthy.
- **Wildlife benefits** – Choose trees that are preferred by wildlife for food, cover, or nesting. A mixture of evergreens and hardwoods may be beneficial. Evergreen trees are important cover during winter months, whereas hardwoods are more valuable for food.

Construction activities can significantly injure or kill trees unless protective measures are taken. Although direct contact by equipment is an obvious means of damaging trees, most serious damage is caused by root zone stress from compacting, filling, or excavating too close to the tree. Clearly mark boundaries to maintain sufficient undisturbed area around the trees.



- Design Criteria** The following general criteria should be considered when developing in a wooded area:
- Leave critical areas (such as floodplains, steep slopes, and wetlands) with desirable trees in their natural condition or only partially cleared.
  - Locate roadways, storage areas, and parking pads away from valuable tree stands. Follow natural contours, where feasible, to minimize cutting and filling in the vicinity of trees.
  - Select trees to be preserved before siting roads, buildings and other structures.
  - Minimize trenching in areas with trees. Place several utilities in the same trench.
  - Designate groups of trees and individual trees to be saved on the EPSC plan sheets and in the SWPPP.
  - **Do not excavate, traverse, or fill closer than the drip line, or perimeter of the canopy, of trees to be preserved.**
- Construction Specifications**
1. Place barriers to prevent the approach of equipment within the drip line of the trees to be preserved.
  2. Do not nail boards to trees during building operations.
  3. Do not cut tree roots inside the drip line.
  4. Do not place equipment, construction materials, topsoil, or fill dirt within the limit of the drip line of trees to be preserved.
  5. If a tree marked for preservation is damaged, remove it and replace it with a tree of the same or similar species, 2-inch caliper or larger, from balled and burlaped nursery stock when activity in the area is complete.
  6. During final site cleanup, remove barriers from around trees.
- Maintenance and Inspection Points**
- In spite of precautions, some damage to protected trees may occur. In such cases, repair any damage to the crown, trunk or root system immediately.
- Repair roots by cutting off the damaged. Spread peat moss or moist topsoil over exposed roots.
  - Repair damage to bark by trimming around the damaged area, taper the cut to provide drainage, and paint with tree paint.
  - Cut off all damaged tree limbs above the tree collar at the trunk or main branch. Use three separate cuts to avoid peeling bark from healthy areas of the tree.

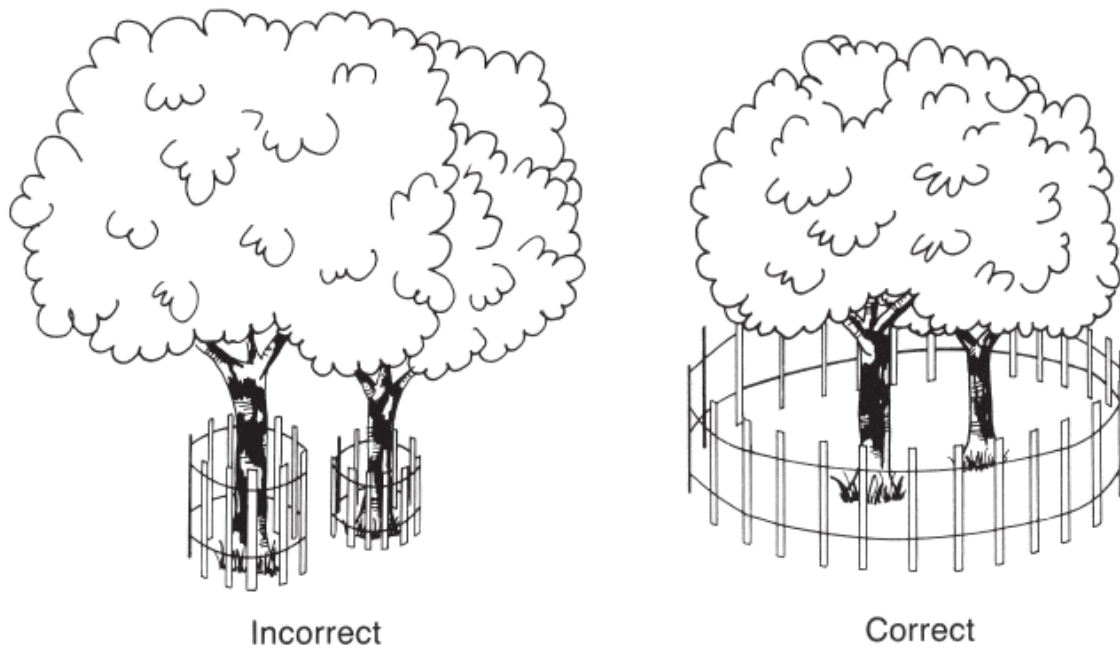

**Figure 7-1** Construction barriers should be installed at the drip line of the tree branches.

**References** *North Carolina Erosion and Sediment Control Planning and Design Manual*

## 7.5 SURFACE ROUGHENING AND TRACKING



**Definition** Roughening a bare soil surface with horizontal grooves running across the slope, stair stepping, or tracking with construction equipment.

**Purpose** To aid the establishment of vegetative cover from seed, to reduce runoff velocity and increase infiltration, and to reduce erosion and provide for sediment trapping.

**Conditions Where Practice Applies** All construction slopes require surface roughening to facilitate stabilization with vegetation, particularly slopes steeper than 3:1. Slopes to be covered with rolled erosion control products need not be roughened.

**Planning Considerations** Rough slope surfaces are preferred because they aid the establishment of vegetation, improve water infiltration, and decrease runoff velocity. Graded areas with smooth, hard surfaces may be initially attractive, but such surfaces increase the potential for erosion. A rough, loose soil surface gives a mulching effect that protects lime, fertilizer, and seed. Nicks in the surface are cooler and provide more favorable moisture conditions than hard, smooth surfaces; this aids seed germination.

There are different methods for achieving a roughened soil surface on a slope, and the selection of an appropriate method depends upon the type of slope. Roughening methods include stair-step grading and tracking. Factors to be considered in choosing a method are slope steepness, mowing requirements, and whether the slope is formed by cutting or filling.

**Design Criteria** No formal design is required.

**Construction Specifications****CUT SLOPE ROUGHENING FOR AREAS NOT TO BE MOWED**

- Stair-step grade slopes with a gradient steeper than 3:1.
- Use stair-step grading on any erodible material soft enough to be ripped with a bulldozer. Slopes consisting of soft rock with some subsoil are particularly suited to stair-step grading.
- Make the vertical cut distance less than the horizontal distance, and slightly slope the horizontal position of the “step” in toward the vertical wall.
- Do not make individual vertical cuts more than 2 feet in soft materials or more than 3 feet in rocky materials.

**FILL SLOPE ROUGHENING FOR AREAS NOT TO BE MOWED**

- Place fill slopes with a gradient steeper than 3:1 in lifts not to exceed 9 inches, and make sure each lift is properly compacted. Ensure that the face of the slope consists of loose, uncompacted fill 4 to 6 inches deep.
- Do not blade or scrape the final slope.

**CUTS, FILLS AND GRADED AREAS THAT WILL BE MOWED**

- Make mowed slopes **no steeper than 3:1**.
- Roughen these areas to shallow grooves by normal tilling, disking, harrowing, or use of cultipacker-seeder. Make the final pass of any such tillage implement on the contour.
- Make grooves, formed by such implements, close together (less than 10 inches) and not less than 1 inch deep.
- Excessive roughness is undesirable where mowing is planned.

**ROUGHENING WITH TRACKED MACHINERY**

- Limit roughening with tracked machinery to sandy soils to avoid undue compaction of the soil surface. Tracking is generally not as effective as the other roughening methods described.
- Operate tracked machinery up and down the slope to leave horizontal depressions in the soil. Do not back-blade during the final grading operation.
- **Seeding** – Immediately seed and mulch roughened areas to obtain optimum seed germination and growth.

**Maintenance and Inspection Points**

Periodically check the seeded slopes for rills and washes. Fill these areas slightly above the original grade, then reseed and mulch as soon as possible.

If a storm event occurs, it is likely that the surface roughening will have to be redone. Surface roughening is a temporary measure. If roughening is washed away in a heavy storm, the surface will have to be re-roughened and new seed laid.

**References**

*North Carolina Erosion and Sediment Control Planning and Design Manual*

## STABILIZATION PRACTICES

### 7.6 STABILIZATION WITH STRAW MULCH



STABILIZATION WITH STRAW MULCH

- Definition** Application of a temporary protective blanket of straw to the soil surface.
- Purpose** To protect the soil surface from the forces of raindrop impact and overland flow. Mulch reduces runoff and erosion, conserves soil moisture, promotes seed germination, insulates soil, suppresses weed growth, and prevents surface crusting.
- Conditions Where Practice Applies** Mulch seeded areas immediately. Areas that cannot be seeded because of the season should be mulched to provide temporary protection of the soil surface.
- Planning Considerations** A surface mulch is considered the most effective, practical means of controlling runoff and erosion on disturbed land prior to vegetative establishment. Mulch reduces soil moisture loss by evaporation, prevents crusting and sealing of the soil surface, moderates soil temperatures, provides a suitable microclimate for seed germination, and may increase the infiltration rate of soil.
- Straw mulch is the most common type of mulch used in conjunction with seeding or providing a temporary groundcover. The straw should come from wheat or oats (“small grains”), and may be spread by hand or with a mulch blower. Note that straw may be lost to wind and must be tacked down. The recommended application rate for straw mulch is 2 tons per acre, dry unchopped, unweathered.
- Note that the goal is 70% uniform coverage over 100% of the site. Straw mulch is often used in conjunction with some channel liners.
- Design Criteria** No formal design is required.



**Construction Specifications**

Before applying mulch, complete the required grading, install sediment control practices, and, if applying seed, prepare the seed bed. When applying seed in combination with mulch, apply the seed before mulch except in the following cases:

- Seed is applied as a part of a hydroseeder slurry containing mulch.
- A hydroseeder slurry is applied over straw.

**Application:**

Spread mulch uniformly by hand or with a mulch blower. When spreading mulch by hand, divide the area to be mulched into sections of approximately 1000 ft<sup>2</sup> and place 70-90 lbs of straw (1.5 to 2 bales) in each section to facilitate uniform distribution. After spreading mulch, no more than 25% of the soil surface should be visible. In hydroseeding applications a green dye added to the slurry assures a uniform application.

**Anchoring:**

**Straw mulch must be anchored immediately after spreading.** The following methods may be used.

**Mulch Anchoring Tool:** Straw mulch may be pressed into the soil immediately after the mulch is spread. A special crimper or disk harrow with the discs set straight may be used. Serrated discs are preferred and should be 20 inches or more in diameter and 8 to 12 inches apart. The edges of the discs shall be dull enough to press the mulch into the ground without cutting it. Mulch should not be plowed into the soil. This method is limited on slopes no steeper than 3:1, where equipment can operate safely. Operate machinery on the contour.

**Liquid Mulch Binders:** Application of liquid mulch binders and tackifiers should be heaviest at the edges, crests of ridges, and banks to resist wind. Binders should be applied uniformly to the remaining area. Binders must be applied after the mulch is spread, or may be sprayed into the mulch as it is being applied. Applying the straw and binder together is the most effective method. Liquid binders include emulsified asphalt and an array of commercially available synthetic binders.

Emulsified asphalt is the most commonly used mulch binder. Any type thin enough to be blown from spray equipment is satisfactory. Asphalt is classified according to the time it takes to cure. Rapid setting (RS or CRS designation) is formulated for curing in less than 24 hours, even during periods of high humidity. It is best used in fall and spring. Medium setting (MS or CMS) is formulated for curing in 24 to 48 hours, and slow setting (SS or CSS) is formulated for use during hot, dry weather, requiring 48 hours or more curing time.

Apply asphalt at 0.10 gallons per square yard (10 gal/1000 ft<sup>2</sup>). Heavier applications cause straw to “perch” over rills.

In traffic areas, uncured asphalt can be picked up on shoes and cause damage to rugs, clothing, etc. Use types RS or CRS to minimize such problems. Synthetic binders may be used to anchor mulch. Follow the manufacturer’s recommended application method and rate. Most synthetic binders are expensive and are therefore used mostly in small areas or in residential areas where asphalt may be a problem.

**Mulch Nettings:** Lightweight plastic, cotton, jute, wire, or paper nets may be stapled over the mulch according to manufacturer's recommendations. Note that single net RECPs with integrated mulch may be used instead of separate mulch with netting.

**Maintenance and Inspection Points** Inspect all mulches periodically, and after rainstorms to check for rill erosion, dislocation or failure. Where erosion is observed, apply additional mulch. If washout occurs, repair the slope grade, reseed and reinstall mulch. Continue inspecting mulched areas until vegetation has firmly established or until construction activities resume in the area.

**References** *North Carolina Erosion and Sediment Control Planning and Design Manual*

## STABILIZATION PRACTICES

### 7.7 STABILIZATION WITH OTHER MULCH MATERIALS



STABILIZATION WITH OTHER MULCHES

*Ground trees were used to stabilize the flat portion of the site above.*

<b>Definition</b>	Application of a protective blanket of plant residues, wood chips, or other organic material, produced on the site if possible, to the soil surface.
<b>Purpose</b>	To protect the soil surface from the forces of raindrop impact and overland flow. Mulch reduces runoff and erosion, conserves soil moisture, promotes seed germination, insulates soil, suppresses weed growth, and prevents surface crusting.
<b>Conditions Where Practice Applies</b>	This practice is applicable for areas that require temporary stabilization until permanent vegetation can establish. These mulches should be applied on areas that are not to be mowed. In addition, do not use in drainages or areas of concentrated flow. Specific applications include: <ul style="list-style-type: none"> <li>• Exposed areas that cannot be seeded due to seasonal conditions.</li> <li>• On areas that are not to be mowed, such as trees, shrubs, or ground covers to stabilize the soil between plants.</li> </ul>
<b>Planning Considerations</b>	Woody plant residue, wood chips and mulches that cannot be anchored down are susceptible to floating and movement by water. These materials should not be used in areas of concentrated flow or high sheet flow.
<b>Design Criteria</b>	The choice of materials for mulching should be based on soil conditions, season, type of vegetation, and size of the area. <p><b>Wood Chips:</b> Wood chips are suitable for areas that will not be closely mowed, and around ornamental plantings. Chips do not require tacking. Because they decompose slowly they must be treated with 12 lbs of nitrogen per ton to prevent nutrient deficiency in plants. This can be an inexpensive mulch if chips are obtained from trees cleared on the site.</p>

**Bark Chips and Shredded Bark:**

Bark chips and shredded bark are byproducts of timber processing that are often used in landscape plantings. Bark is also suitable mulch for areas planted to grasses and not closely mowed. It may be applied by hand or with a mulch blower; do not use a tackifier. Unlike the use of wood chips, bark does not require additional nitrogen fertilizer.

**Wood Fiber:**

Wood fiber refers to short cellulose fibers applied as a slurry in hydroseeding operations. Wood fiber does not require tacking, although tacking agents or soil binders could be easily added to the slurry. Wood fiber hydroseeder slurries may be used to tack straw mulch on steep slopes, critical areas, and where harsh climatic conditions exist. Wood fiber does not provide sufficient erosion protection to be used alone.

**Construction Specifications**

Before applying mulch, complete the required grading and install sediment control practices. Woody plant residue mulch should not be used where seed is being or has been applied.

**Materials:** Organic mulch such as wood chips or bark shall be applied at a rate that provides 70% or greater soil coverage. Organic material from the clearing stage of development should remain on site, be chipped, and applied as mulch. This method of mulching greatly reduces erosion control costs. This method however, should not be used in conjunction with seeding due to soil acidification and nitrogen reduction problems that the decomposition of the “green” material will produce.

**Maintenance and Inspection Points**

Inspect all mulches periodically, and after rainstorms to check for rill erosion, dislocation or failure. Where erosion is observed, apply additional mulch. If washout occurs, repair the slope grade, reseed and reinstall mulch. Continue inspections until vegetation has firmly established.

**References**

*North Carolina Erosion and Sediment Control Planning and Design Manual*  
*CALTRANS Roadside Management Toolbox*

## STABILIZATION PRACTICES

### 7.8 TEMPORARY VEGETATION

**TS**

 STABILIZATION WITH TEMPORARY  
VEGETATION

**Definition** The establishment of temporary vegetative cover with fast growing species for seasonal protection on disturbed or denuded areas.

**Purpose** To temporarily stabilize denuded areas that will not be brought to final grade for a period of more than 14 days.

Temporary seeding controls runoff and erosion until permanent vegetation or other erosion control measures can be established. Seeding with a temporary groundcover provides temporary stabilization until permanent stabilization can be achieved. In addition, it provides residue for soil protection and seedbed preparation, and reduces problems of mud and dust production from bare soil surfaces during construction.

**Conditions Where Practice Applies** On any cleared, unvegetated, or sparsely vegetated soil surface where vegetative cover is needed for less than 1 year.

For permanent seeding specifications, see Section 7.9.

**Planning Considerations** Annual plants that sprout and grow rapidly and survive for only one season are suitable for establishing initial or temporary vegetative cover. Temporary seeding preserves the integrity of earthen sediment control structures such as dikes, diversions, and the banks of dams and sediment basins. It can also reduce the amount of maintenance associated with these devices. For example, the frequency of sediment basin cleanouts will be reduced if the watershed areas outside the active construction zone are stabilized.

Proper seedbed preparation, selection of appropriate species, and the use of quality seed are important. Failure to follow established guidelines and recommendations carefully may result in an inadequate or short-lived stand of vegetation that will not control erosion. Temporary seeding provides protection for no more than 1 year, during which time permanent stabilization should be initiated.



**Design Criteria** Complete grading before preparing seedbeds, and install all necessary erosion control practices such as dikes, waterways, and basins. Minimize steep slopes because they make seedbed preparation difficult and increase the erosion hazard. If soils become compacted during grading, loosen them to a depth of 6-8 inches using a ripper, harrow, or chisel plow.

**Construction Specifications** **Grading and Shaping:** Excessive water runoff shall be reduced by properly designed and installed erosion control practices such as ditches, dikes, diversions, and sediment basins. No shaping or grading is required if slopes can be stabilized by hand-seeded vegetation or if hydraulic seeding equipment is to be used.

**Seedbed Preparation:** Good seedbed preparation is essential to successful plant establishment. A good seedbed is well pulverized, loose and uniform. Where hydroseeding methods are used, the surface may be left with a more irregular surface of large clods and stones.

**Liming:** Apply lime according to soil test recommendations. If the pH (acidity) of the soil is not known, an application of ground agricultural limestone at the rate of 1 to 1½ tons/acre on coarse textured soils and 2-3 tons/acre on fine textured soils is usually sufficient. Apply limestone uniformly and incorporate into the top 4-6 inches of soil. Soils with a pH of 6 or higher do not need to be limed.

**Fertilizer:** Base application rates on soil tests. When soil tests are not possible, apply a 10-10-10 grade fertilizer at 700-1000lb/acre. Both fertilizer and lime should be incorporated into the top 4-6 inches of soil. If a hydraulic seeder is used, do not mix seed and fertilizer more than 30 minutes before the application.

**Surface Roughening:** If recent tillage operations have resulted in a loose surface, additional roughening may not be necessary, except to break up large clods. If rainfall caused the surface to become sealed or crusted, loosen it just prior to seeding by disking, raking, harrowing, or other suitable methods. Groove or furrow slopes steeper than 3:1 on the contour before seeding.

**Seeding:** Select a non-invasive grass or grass-legume mixture suitable to the area and season of the year. See Figures 7.8-1 to 7.8-3 for suggestions of temporary seeding species. Although native plants are preferred, there are currently no available native species that are not cost prohibitive. Non-invasive annual plants are preferred. Seed shall be applied uniformly by hand, cyclone seeder, drill, cultipacker seeder, or hydraulic seeder. Drill or cultipacker seeders should normally place seed ¼ to ½ inches deep. Appropriate depth of planting is 10 times the seed diameter. Soil should be raked lightly to cover seed with soil if seeded by hand.

**Mulching:** The use of mulch will help ensure establishment under normal conditions, and is essential to seeding success under harsh site conditions. Harsh site conditions include:

- Seeding in fall for winter cover
- Slopes steeper than 3:1
- Excessively hot or dry weather
- Adverse soils (shallow, rocky, or high in clay or sand), and
- Areas receiving concentrated flow.

**Irrigation:** During times of drought, water shall be applied at a rate not causing runoff and erosion. The soil shall be thoroughly wetted to a depth that will ensure germination of the seed. Subsequent applications should be made as needed. Newly seeded areas require more water than more mature plants.

<b>Species</b>	<b>Rate (lb/acre)</b>
Rye	120
<b>Seeding dates</b>	
East .....	Above 2500 feet: Feb. 15 - May 15 Below 2500 feet: Feb. 1- May 1
Middle .....	Jan. 1 - May 1
West .....	Dec. 1 - Apr. 15
<b>Soil amendments</b>	
Follow recommendations of soil tests or apply 2,000 lb/acre ground agricultural limestone and 750 lb/acre 10-10-10 fertilizer.	
<b>Mulch</b>	
Apply 4,000 lb/acre straw. Anchor straw by tacking with asphalt, netting, or a mulch anchoring tool. A disk with blades set nearly straight can be used as a mulch anchoring tool.	
<b>Maintenance</b>	
Refertilize if growth is not fully adequate. Reseed, refertilize and mulch immediately following erosion or other damage.	

**Figure 7.8-1 Temporary Seeding Recommendation for Late Winter and Early Spring**

<b>Species</b>	<b>Rate (lb/acre)</b>
Oats	60
Brown top millet	30
<b>Seeding dates</b>	
East .....	May 15 - Aug. 15
Middle .....	May 1 - Aug. 15
West .....	Apr. 15 - Aug. 15
<b>Soil amendments</b>	
Follow recommendations of soil tests or apply 2,000 lb/acre ground agricultural limestone and 750 lb/acre 10-10-10 fertilizer.	
<b>Mulch</b>	
Apply 4,000 lb/acre straw. Anchor straw by tacking with asphalt, netting, or a mulch anchoring tool. A disk with blades set nearly straight can be used as a mulch anchoring tool.	
<b>Maintenance</b>	
Refertilize if growth is not fully adequate. Reseed, refertilize and mulch immediately following erosion or other damage.	

**Figure 7.8-2 Temporary Seeding Recommendation for Summer**

<b>Species</b>	<b>Rate (lb/acre)</b>
Oats	30
Winter wheat	30
 <b>Seeding dates</b>	
East .....	Aug 15 – Dec 15
Middle .....	Aug. 15 – Dec 30
West .....	Aug. 15 – Dec 30
 <b>Soil amendments</b>	
Follow recommendations of soil tests or apply 2,000 lb/acre ground agricultural limestone and 750 lb/acre 10-10-10 fertilizer.	
 <b>Mulch</b>	
Apply 4,000 lb/acre straw. Anchor straw by tacking with asphalt, netting, or a mulch anchoring tool. A disk with blades set nearly straight can be used as a mulch anchoring tool.	
 <b>Maintenance</b>	
Refertilize if growth is not fully adequate. Reseed, refertilize and mulch immediately following erosion or other damage. If necessary to extend temporary cover beyond June 15, overseed with 50 lb/ac crimson clover in late February or early March.	

**Figure 7.8-3 Temporary Seeding Recommendations for Fall**

**Maintenance and Inspection Points**      Reseed and mulch areas where seedling emergence is poor or where erosion occurs, as soon as possible. Do not mow.

**References**      *North Carolina Erosion and Sediment Control Planning and Design Manual*

## STABILIZATION PRACTICES

### 7.9 PERMANENT VEGETATION



STABILIZATION WITH PERMANENT  
VEGETATION

**Definition** The planting of native perennial vegetation such as ground covers, shrubs, vines, trees, and/or flowering plants (forbs) on exposed areas for erosion control and final stabilization. Permanent perennial vegetation is required to achieve final stabilization. Native perennial plants are preferred for erosion control because of the following reasons:

- In appropriate habitats, native plants are better adapted to environmental and site conditions, resulting in lower maintenance costs
- Natives are not typically aggressive and do not allow the site to become a source of exotic invasive plants that can spread to other locations and become costly to remove
- Unlike most non-natives, native plants support native insect, bird, and other wildlife for pollinations, food sources, and nesting
- Using native plants provides opportunities to educate and demonstrate various sustainable approaches for the public
- The Tennessee Exotic Pest Plant (TNEPPC) council has ranked non-native plants in Tennessee based on their invasiveness and threats to the natural environment. The following plants that have been used for erosion control by TDEC and TDOT are listed in TNEPPC's publication "**Invasive Exotic Pest Plants in Tennessee – 2009**":
  - Korean (and Kobe) lespedeza – “Severe Threat” Category (Kobe is not ranked but has same invasive characteristics as Korean)
  - Tall fescue – “Significant Threat” Category

- Foxtail millet – “Significant Threat” Category
- Crown vetch – “Alert” Category

We are providing native and non-invasive alternative species as the preferred choice for erosion control and soil stabilization for TDEC projects. (Table 7.9-1)

<b>Purpose</b>	To reduce stormwater runoff velocity, maintain sheet flow, protect the soil surface from erosion, promote infiltration of runoff into the soil, and improve aesthetics and provide diversity. Many native grasses have very deep and fibrous roots, a minimum of one foot and up to fifteen feet, and provide long-term erosion control.
<b>Conditions Where Practice Applies</b>	Apply to fine-graded areas on which permanent, long-lived vegetative cover is the most practical or most effective method of stabilizing the soil. Permanent seeding may also be used on rough-graded areas that will not be brought to final grade for a year or more. Areas to be seeded with permanent vegetation must be seeded or planted within 14 days after the construction activity in that portion of the site has permanently ceased.
<b>Planning Considerations</b>	<p>The most common and economical means of stabilizing disturbed soils is by seeding a mixture of grasses and forbs. The advantages of seeding over other means of establishing plants include the smaller initial cost, lower labor input, and greater flexibility of method. The disadvantages of seeding include the potential for erosion during the establishment stage, the need to reseed areas that fail to establish, seasonal limitations on suitable seeding dates, and a need for water and appropriate temperatures during germination and early growth. The probability of successful plant establishment can be maximized through good planning, knowledge of the soil characteristics, selection of suitable plant materials for the site, good seedbed preparation, adequate liming and fertilization, and timely planting and maintenance.</p> <p>Native grasses can be planted by drilling or seeding. The ground should be prepared by discing or rotovating prior to seeding in the spring or summer. Annual grains such as rye or oats can be planted prior to sowing the grass seed for erosion control. Grass seed can be planted in the dormant season as well.</p> <p>Permanent perennial vegetation is used to provide a protective cover for exposed areas including cuts, fill, and other denuded areas that will not be regraded. Permanent stabilization should be applied where topsoil was never stripped, or has been returned and incorporated into the soil surface.</p> <ul style="list-style-type: none"> <li>• When stripping a site, topsoil should be stockpiled for later use.</li> <li>• Stockpiled topsoil should be stabilized using temporary vegetation.</li> <li>• Where a suitable planting medium is not present, topsoil shall be imported and incorporated into the site.</li> <li>• Block sod provides immediate cover; it is especially effective in controlling erosion adjacent to concrete flumes and other structures. .</li> <li>• When mixed plantings are done during marginal planting periods, companion crops shall be used.</li> <li>• No-till planting can be effective when planting is done following a summer or winter annual cover crop.</li> <li>• Irrigation should be used when the soil is dry or when summer plantings are done.</li> </ul>



- Native species are low maintenance plants and are preferred to ensure long-lasting erosion control.
- Wildlife plantings of native species should be included when applicable.

**Wildlife Plantings:** Commercially available plants beneficial to wildlife species include the following:

- Mast Bearing Trees: Beech, Black Cherry, Blackgum, Chestnut, Oak, Hackberry, Hickory, Honey Locust, Black Locust, and Persimmon.
- Shrubs and Small Trees: Serviceberry, Crabapple, Pawpaw, Spicebush, Hazelnut, Dogwood, Highbush and Lowbush Blueberries, native Holly, Red Cedar, Red Mulberry, Sumac, Wild Plum, Blackhaw and Blackberry. Plant shrubs in patches without tall trees to develop stable shrub communities. All produce fruit used by many kinds of wildlife.

**Design Criteria** The state is divided into three planting regions designated I, II and III as shown in the figure below. Native seed mixes are preferred and the recommendations are shown in Table 7-9.1. Note that the rates are based upon Pure Live Seed (PLS).

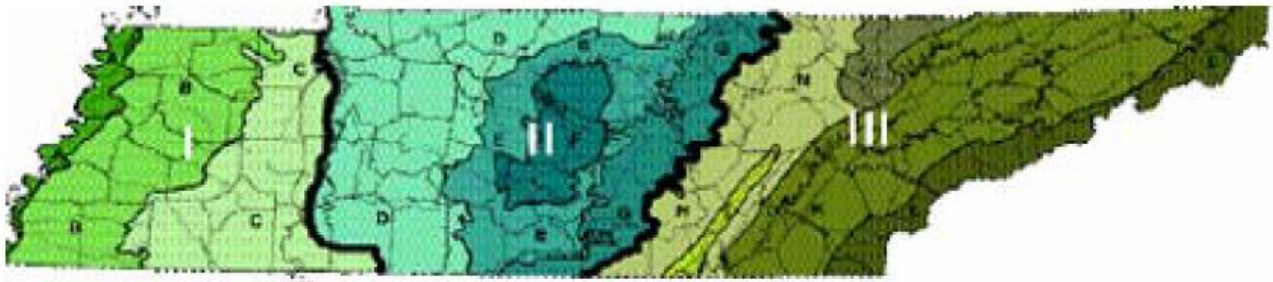

**Figure 7.9-1: TN Planting Regions**

**Table 7.9-1 Preferred seed mixes using natives or naturalized plants and planting dates.***\*non-native but do not spread.*

Zone		Best	Marginal	Preferred Rate/Mix (lb/ac PLS)
<b>Region I</b>	Poorly drained soils	Feb 1 – Mar 20 Sept 1 – Sept 30	Mar 20 – Apr 30 Sept 30 – Oct 31	15 Browntop millet* (nurse crop) 2 switch grass 4 little bluestem 4 Virginia wild rye 4 purpletop 2 partridge pea 2 black-eyed susan
	Well drained soils	Apr 1 – July 15		15 Browntop millet* (nurse crop) 4 little blue stem 4 purpletop 2 sideoats gramma 2 partridge pea 2 black-eyed susan
	High maintenance	Apr 1 – July 15		15 Browntop millet* (nurse crop) 2 partridge pea 45 Red fescue* 45 hard fescue* 25 chewing fescue*
<b>Region II</b>	Low maintenance; Slopes and Poor, shallow soils	Aug 25 – Sept 15 <b>Feb 15 – May 30</b>	Sept 15 – Oct 25 Mar 21 – May 30	15 Browntop millet* (nurse crop) 5 little bluestem 2 switch grass 2 tall dropseed 5 sideoats gramma 2 black-eyed susan 2 partridge pea 1 greyheaded coneflower
	Low maintenance; Moderate slopes; soils >6 in. depth	Aug 25 – Sept 15 <b>Feb 15 – May 30</b>	Sept 15 – Oct 25 Mar 21 – Apr 15	15 Browntop millet* (nurse crop) 5 purpletop 5 little bluestem 5 Virginia wild rye 2 black-eyed susan 2 partridge pea 1 greyheaded coneflower
	High maintenance	Aug 30 – Oct 15	Feb 15 – Apr 15	15 Browntop millet* (nurse crop) 2 partridge pea 45 Red fescue* 45 hard fescue* 25 chewing fescue*
<b>Region III</b>	>2500 ft elevation; steep slopes	Mar 20 – Apr 30	Aug 15 – Aug 30 Mar 1 – Mar 20 Apr 20 – June 15	15 Browntop millet* (nurse crop) 5 purpletop 10 little bluestem 10 Indian grass
	<2500 ft elevation; steep slopes	Aug 15 – Sept 1 <b>Mar 1 – Apr 1</b>	Sept 1 – Sept 15 Apr 1 – June 10	2 black-eyed susan 0.5 monarda (bergamot) 4 Maryland senna

<b>Region III</b> <i>cont'd</i>	>2500 ft elev.; Shallow soils	Mar 20 – Apr 20	Aug 15 – Aug 30 Mar 5 – Mar 20 April 20 – June 15	15 Browntop millet* (nurse crop) 4 purpletop 10 little bluestem 10 broomsedge 2 partridge pea 2 black-eyed susan 0.5 monarda (bergamot)
	<2500 ft elev.; Shallow soils	Aug 15 – Sept 1 <b>Mar 1 – Apr 1</b>	Sept 1 – Sept 15 Apr 1 – June 10	15 Browntop millet* (nurse crop) 4 purpletop 10 little bluestem 10 Indian grass 2 black-eyed susan 0.5 monarda (bergamot) 4 Maryland senna
	>2500 ft. elev.; Moderate slopes	Mar 20 – Apr 20	Aug 15 – Aug 30 Mar 5 – Mar 20 Apr 20 – June 15	15 Browntop millet* (nurse crop) 4 purpletop 10 little bluestem 10 Indian grass 2 black-eyed susan 0.5 monarda (bergamot) 4 Maryland senna
	<2500 ft. elev.; Moderate slopes	Aug 15 – Sept 1 <b>Mar 1 – Apr 1</b>	Sept 1 – Sept 15 Apr 1 – June 10	15 Browntop millet* (nurse crop) 45 Red fescue* 45 hard fescue* 25 chewing fescue*
	>2500 ft elev.; High maintenance	<b>Mar 20 – Apr 20</b>	Aug 15 – Aug 30 Mar 5 – Mar 20 Apr 20 – June 15	15 Browntop millet* (nurse crop) 45 Red fescue* 45 hard fescue* 25 chewing fescue*
	<2500 ft elev.; High maintenance	Aug 15 – Sept 1 <b>Mar 1 – Apr 1</b>	Sept 1 – Sept 15 Apr 1 – June 10	15 Browntop millet* (nurse crop) 45 Red fescue* 45 hard fescue* 25 chewing fescue*

In Table 7.9-1, the bold dates are the preferred dates for seeding. Also, high maintenance areas include lawns and other grassed areas that will be maintained for aesthetics.

**Table 7.9-2 Allowable seed mixes and planting dates.**

	<b>Zone</b>	<b>Best</b>	<b>Marginal</b>	<b>Rate/Mix (lb/ac PLS)</b>
<b>Region I</b>	Poorly drained soils	Feb 1 – Mar 20 Sept 1 – Sept 30	Mar 20 – Apr 30 Sept 30 – Oct 31	80 Pensacola bahiagrass 30 Bermudagrass (hulled) 20 Korean lespedeza** 10 Kobe lespedeza**
	Well drained soils	Apr 1 – July 15		50 Pensacola bahiagrass 15 Bermudagrass (hulled) 30 Korean lespedeza** 15 Foxtail millet**
	High maintenance	Apr 1 – July 15		40 Bermudagrass (hulled)
<b>Region II</b>	Low maintenance; Slopes and Poor, shallow soils	Aug 25 – Sept 15 <b>Feb 15 – Mar 21</b>	Sept 15 – Oct 25 Mar 21 – Apr 15	100 Pensacola bahiagrass 40 Bermudagrass (hulled) 20 Korean lespedeza** 10 Kobe lespedeza**
	Low maintenance; Moderate slopes; soils >6 in. depth	Aug 25 – Sept 15 <b>Feb 15 – Mar 21</b>	Sept 15 – Oct 25 Mar 21 – Apr 15	80 Pensacola bahiagrass 30 Bermudagrass (hulled) 20 Korean lespedeza** 10 Kobe lespedeza**
	High maintenance	Aug 15 – Oct 15	Feb 15 – Apr 15	200 KY 31 fescue**

<b>Region III</b>	>2500 ft elevation; steep slopes	July 25 - Aug 15 <b>Mar 20 – Apr 20</b>	July 15 – July 25 Aug 15 – Aug 30 Mar 1- Mar 20 Apr 20 – May 15	100 KY 31 fescue** 20 Kobe lespedeza** 10 Korean lespedeza** 5 Redtop
	<2500 ft elevation; steep slopes	Aug 15 – Sept 1 <b>Mar 1 – Apr 1</b>	July 25 – Aug 15 Sept 1 – Sept 15 Apr 1 – May 10	
	>2500 ft elev.; Shallow soils	July 25 - Aug 15 <b>Mar 20 – Apr 20</b>	July 15 – July 25 Aug 15 – Aug 30 Mar 5 – Mar 20 Apr 20 – May 15	40 KY 31 Fescue** 10 Korean lespedeza** 10 Redtop
	<2500 ft elev.; Shallow soils	Aug 15 – Sept 1 <b>Mar 1 – Apr 1</b>	July 25 – Aug 15 Sept 1 – Sept 15 Apr 1 – May 10	10 Crown vetch**
	>2500 ft. elev.; Moderate slopes	July 25- Aug 15 <b>Mar 20 – Apr 20</b>	July 15 – July 25 Aug 15 – Aug 30 Mar 5 – Mar 20 Apr 20 – May 15	60 KY 31 fescue** 15 Korean lespedeza** 15 Kobe lespedeza**
	<2500 ft. elev.; Moderate slopes	Aug 15 – Sept 1 <b>Mar 1 – Apr 1</b>	July 25 – Aug 15 Sept 1 – Sept 15 Apr 1 – May 10	
	>2500 ft elev.; High maintenance	July 25 - Aug 15 <b>Mar 20 – Apr 20</b>	July 15 – July 25 Aug 15 – Aug 30 Mar 5 – Mar 20 Apr 20 – May 15	200 KY 31 fescue**
	<2500 ft elev.; High maintenance	Aug 15 – Sept 1 <b>Mar 1 – Apr 1</b>	July 25 – Aug 15 Sept 1 – Sept 15 Apr 1 – May 10	



Figure 7.9-2 Typical Seed

Roundstone Native Seed, LLC  
9764 Raider Hollow Road, Upton, KY 42784

<i>Kind: Switchgrass</i>		<i>Lot No: 11074</i>	
<i>Variety:</i>	<i>Cave-in-Rock</i>	<i>Inert Matter:</i>	<i>1.78</i>
<i>Origin:</i>	<i>KY</i>	<i>Weed Seeds:</i>	<i>0.00</i>
<i>Test Date:</i>	<i>02/12</i>	<i>Crop Seeds:</i>	<i>0.00</i>
<i>Pure Seed:</i>	<i>98.22</i>	<i>Hard Seed:</i>	<i>0.00</i>
<i>Total Germ:</i>	<i>95.32</i>	<i>Germ:</i>	<i>95.32</i>
<i>Pure Live Seed:</i>	<i>93.62</i>	<i>Noxious:</i>	<i>0.00</i>

**Seeding rates:** Seed rates in Table 7.9-1 are based upon Pure Live Seed (PLS), which is the product of the purity shown on the seed tag multiplied by the germination. The PLS for the seed tag shown in Figure 7.9-2 would be  $0.9362 \times 0.95 = 0.89$ . Thus only 89% of the seed are considered live. If the plan calls for a seed rate of 2 lb/acre of switchgrass find the actual seed rate for the conditions shown on the tag. Actual seed rate required is  $2 \text{ lb/ac} / 0.95 \text{ PLS} = 2.15 \text{ lb/acre}$ . In other words, to get an actual rate of 2 lb. per acre it will require 2.15 lb. of seed.

Temporary seed may be required when seeding outside of the preferred seeding dates. See Section 7.8 for more information on temporary seeding.

**Construction Specifications**

**Grading and Shaping:** Grading and shaping may not be required where hydraulic seeding and fertilizing equipment is to be used. Vertical banks shall be sloped to enable plant establishment.

When conventional seeding and fertilizing are to be done, grade and shape the slope, where feasible and practical, so that equipment can be used safely and efficiently during seedbed preparation, seeding, mulching, and maintenance of vegetation.

Concentrations of water that could cause excessive soil erosion should be diverted to a safe outlet. Diversions and other treatment practices must conform to the appropriate standards and specifications.

**Plant Selection: Only certified seed shall be used.** Refer to Table 7.9-1 for suggested species. Grass type should be selected on the basis of species characteristics; site and soil conditions; planned use and maintenance of the area; time of year of planting, method of planting; and the needs and desires of the land user.

Plant selection may also include annual companion crops. Annual companion crops should be used only when the perennial species are not planted during their optimum planting period. Care should be taken in selecting companion crop species and seeding rates because annual crops will compete with perennial species for water, nutrients, and growing space. A high seeding rate of the companion crop may prevent the establishment of perennial species.

**Ryegrass shall not be used in any seeding mixtures containing permanent, perennial species due to its ability to out-compete desired species chosen for permanent perennial cover. However, crimson, clover, oats and winter wheat can be planted any time of the year and are recommended as a cover crop with native perennial species.**

**Topsoil:** Topsoil should be replaced on all areas to be seeded. See Practice 7.3 for more information on the removal, storage and reapplication of topsoil.

**Seedbed Preparation:** When conventional seeding is to be used, topsoil should be applied to any area where the disturbance results in subsoil at the final grade surface. Figure 7.9-3 provides guidance on the volume of topsoil required to provide specific topsoil depths. Soil pH should be above 5 – preferably between 6.0 and 6.5. Soil on the site should be tested to determine lime and fertilizer rates. Soil should be submitted to a soils specialist or County Agricultural Extension agent for testing and soil amendment recommendations. In the absence of soil test results, the following application rates can be used:

- **Ground agricultural limestone:**

- Light-textured, sandy soils: 1- 1 1/2 tons/acre

- Heavy-textured, clayey soils: 2-3 tons/acre

- **Fertilizer:**

- Grasses: 800-1200 lb/acre of 10-10-10 (or the equivalent)

- Grass-legume mixtures: 800-1200 lb/acre of 5-10-10 (or the equivalent)



**Broadcast Seeding:**

- Seedbed preparation may not be required where hydraulic seeding equipment is to be used.
- Tillage, at a minimum, shall adequately loosen the soil to a depth of 4 to 6 inches; alleviate compaction; incorporate topsoil, lime, and fertilizer; smooth and firm the soil; allow for the proper placement of seed, sprigs, or plants; and allow for the anchoring of straw or hay mulch if a crimper is to be used.
- Tillage may be done with any suitable equipment.
- Tillage should be done parallel to the contour where feasible.
- On slopes too steep for the safe operation of tillage equipment, the soil surface shall be pitted or trenched across the slope with appropriate hand tools to provide consecutive beds, 6 to 8 inches apart, in which seed may lodge and germinate. Hydraulic seeding may also be used.

Depth (Inches)	Per 1,000 Square Feet	Per Acre
1	3.1	134
2	6.2	268
3	9.3	403
4	12.4	537
5	15.5	672
6	18.6	806

**7.9-3 Cubic yards of topsoil required to attain various soil depths**

**Inoculants:** Native legume seeds do not need to be inoculated. All non-native legume seed shall be inoculated with appropriate nitrogen fixing bacteria. The inoculants shall be pure culture prepared specifically for the seed species and used within the dates on the container. A mixing medium recommended by the manufacturer shall be used to bond the inoculants to the seed. For conventional seeding, use twice the amount of inoculants recommended by the manufacturer.

**No-Till Seeding:** No-till seeding is permissible into annual cover crops when planting is done following maturity of the cover crop or if the temporary cover stand is sparse enough to allow adequate growth of the permanent (perennial) species. No-till seeding shall be done with appropriate no-till seeding equipment. The seed must be uniformly distributed and planted at the proper depth. Native grasses respond very well to drill seeding at a depth of one-fourth inch.

**Mulch:** Straw mulch is required for all permanent vegetation applications and must be applied immediately after the application of seed. The application rate for mulch is 2 tons per acre with overall uniform soil coverage of 70%. All mulch must be anchored. See Practice 7.6 for more information on straw mulch.

**Maintenance  
and Inspection  
Points**

Any areas that have washed out due to high stormwater flows, areas that have been disturbed by blowing wind, and areas that do not show good germination should be retreated.

Inspect seeded areas for failure and make necessary repairs and reseedings within the same season, if possible.

**Reseeding:** If a stand has inadequate cover, re-evaluate choice of plant materials and quantities of lime and fertilizer. Re-establish the stand after seedbed preparation or over-seed the stand. Consider seeding temporary, annual species if the time of year is not appropriate for permanent seeding.

**References**

*North Carolina Erosion and Sediment Control Planning and Design Manual*

## STABILIZATION PRACTICES

### 7.10 SOD

**SO**

STABILIZATION WITH SOD

**Definition** Permanently stabilizing areas by laying a continuous cover of grass sod.

**Purpose** To prevent erosion and damage from sediment and runoff by stabilizing the soil surface with permanent vegetation where specific goals might be:

- to establish immediate ground cover,
- protect the soil surface from erosion,
- reduce stormwater runoff,
- to stabilize disturbed areas with a suitable plant material that cannot be established by seed, or
- to stabilize drainageways, channels, and other areas of concentrated flow where flow velocities will not exceed that specified for a grass lining.

**Conditions Where Practice Applies** This practice is applicable for areas that require immediate and permanent vegetative cover, or where sodding is preferred over other means of grass establishment. Specific applications include:

- Grass swales or waterways carrying intermittent flow.
- Areas around drop inlets.
- Steep critical areas where vegetative cover may be hard to establish.

**Planning Considerations** Quality turf can be established with either seed or sod; site preparation for the two methods is similar. The practice of sodding for soil stabilization eliminates both the seeding and mulching operations, and is a much more reliable method of producing adequate cover and sediment control. However, compared to seed, sod is more expensive, difficult to obtain, transport, and store.

Advantages of properly installed sod include:

- immediate erosion and dust control,

- nearly year-round establishment capability,
- less chance of failure than with seedings,
- less weeds, and
- rapid stabilization of surfaces for traffic areas, channel linings, or critical areas.

Sod can be laid during times of the year when seeded grasses may fail, provided there is adequate water available for irrigation in the early weeks. Irrigation is essential, at all times of the year, to install sod. It is initially more costly to install sod than to plant seed. However, the higher cost may be justified for specific applications where sod performs better than seed.

In waterways and channels that carry concentrated flow, properly pinned sod is preferable to seed because it provides immediate protection. For channel design, refer to Section 7.27. Drop inlets placed in areas to be grassed can be protected from sediment by placing permanent sod strips around the inlet. Sod also maintains the necessary grade around the inlet.

Because sod is composed of living plants that must receive adequate care, final grading and soil preparation should be completed before sod is delivered. If left rolled or stacked, heat can build up inside the sod, causing severe damage and loss of costly plant material.

**Design Criteria**    **Choosing appropriate types of sod:** The type of sod selected should be composed of plants adapted to both the site and the intended purpose. A complete and current listing of sod recommendations can be obtained from suppliers or the State Agricultural Extension office. Sod composed of a mixture of varieties may be preferred because of its broader range of adaptability. Sod that consists of native species is preferred if available.

In general, warm season grasses such as bermudagrass sod should be used in West TN and cool season grasses such as fescue sod should be used in East TN. Both can be used in Middle TN, with warmer season grasses in southern Middle TN and cooler season grasses in northern Middle TN.

**Construction Specifications**    **Quality of sod: Use only high-quality sod of known genetic origin, free of noxious weeds, disease, and insect problems. It should appear healthy and vigorous, and conform to the following specifications:**

- Sod should be machine cut and contain  $\frac{3}{4}$ " of soil, not including shoots or thatch.
- Sod should not have been cut in excessively wet or dry weather.
- Sod should be cut to the desired size. Torn or uneven pads should be rejected.
- Harvest, delivery, and installation of sod should take place within a period 36 hours.
- Sections of sod should be strong enough to support their own weight and retain their size and shape when lifted by one end.
- Avoid planting when subject to frost heave or hot weather if irrigation is not available.

**Soil Preparation:** Bring the soil surface to final grade. Clear surface of trash, woody debris, stones and clods larger than 1". Fill or level low spots in order to avoid standing water. Mix fertilizer and/or lime into soil surface where necessary. See Section 7.9 for more information on soil amendments.

**Installation:**

- Moistening the sod after it is unrolled helps maintain its viability. Store it in the shade during installation.
- Rake the soil surface to break the crust just before laying sod. During the summer, lightly irrigate the soil, immediately to cool the soil, reduce root burning, and dieback.
- Ensure that the sod is in good contact with the prepared soil surface.
- Do not stretch the sod strips. Instead, maintain the shape of the sod and cut pieces to fit rather than stretching sections.
- Do not install sod on gravel, frozen soils, or soils that have been treated recently with sterilants or herbicides.
- Lay the first row of sod in a straight line with subsequent rows placed parallel to and butting tightly against each other. Stagger strips in a brick-like pattern (see Figure 7-7.10-1). Be sure that the sod is not stretched or overlapped and that all joints are butted tightly to prevent voids.
- Install strips of sod with their longest dimension perpendicular to the slope. On slopes 3:1 or steeper, or wherever erosion may be a problem, secure with pegs or staples.
- As sodding of clearly defined areas is complete, roll sod to provide firm contact between roots and soil.
- After rolling irrigate until the soil is wet 4" below the sod.
- Keep sodded area moist to a depth of 4" until the grass takes root. This can be determined by gently tugging on the sod.
- Mowing should not be attempted until the sod is firmly rooted, usually 2-3 weeks.

**Sodded Waterways:** The sod must be able to withstand the flow velocity specified in the channel design. Lay sod strips perpendicular to the direction of flows, with the lateral joints staggered in a brick-like pattern. Edges should be butted tightly together.

1. Sodded slopes may require pinning to prevent sod from sliding while it is getting established.





**Figure 7-7.10-1. Correct sod placement**

**Maintenance and Inspection Points** After the first week, water as necessary to maintain adequate moisture in the root zone and prevent the sod from going dormant. Grass height should not be cut to less than 2" to 3". Re-sod areas where an adequate stand of sod is not obtained.

**References** *North Carolina Erosion and Sediment Control Planning and Design Manual*

## STABILIZATION PRACTICES

### 7.11 ROLLED EROSION CONTROL PRODUCTS

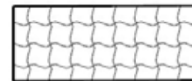

ROLLED EROSION CONTROL PRODUCT

**Definition** Rolled erosion control products (RECPs) are manufactured sheets of mulch materials (e.g., straw, coir, wood fibers, curled wood, etc.) that are bound into netting composed of either photodegradable synthetic or natural materials. They are usually delivered to a construction site in rolls which are then installed as a protective covering designed to protect soil and hold seed and mulch in place on slopes and in channels so that vegetation can become well established. **This section only addresses RECPs applied to slopes. RECPs as channel linings are covered in Section 7.27 Channels.**

**Purpose** To reduce soil erosion and assist in the growth, establishment and protection of temporary or permanent vegetation on steep slopes.

**Conditions Where Practice Applies** RECPs can be applied to steep slopes where erosion hazards are high and conventional seeding is likely to be too slow in providing adequate protective cover. RECPs shall be applied to cut or fill slopes of 2.5:1 or steeper with a height of 10 feet or greater in need of protection during establishment of temporary or permanent ground cover.

**Planning Considerations** There are many types of erosion control nets and blankets on the market that may be appropriate in certain circumstances. In general, most nets require mulch in order to prevent erosion because they have a fairly open structure. Blankets typically do not require mulch because they usually provide complete protection of the surface.

Good ground contact is critical to the effectiveness of these products. If good ground contact is not achieved, runoff can concentrate under the product, resulting in significant erosion. It is preferred that loose woven netting made with natural fibers be used.

Most netting used with blankets is photodegradable, meaning they break down under sunlight (not UV stabilized). However, this process can take months or years even under bright sun. Once vegetation has established, sunlight does

not reach the mesh. It is not uncommon to find non-degraded netting still in place several years after the installation. This can be a problem if maintenance requires the use of mowers or ditch cleaning equipment. In addition, birds and small animals can become trapped in the netting.

Biodegradable blankets are available for use in sensitive areas. These organic blankets are usually held together with a fiber mesh and stitching which may last up to one year.

**Design Criteria** Formal design of RECPs applied to slopes is not required. However, for each location erosion control blankets are used, the type of blanket should be indicated in the EPSC Plans.

The use of erosion control blankets on cut or fill slopes may be considered for the following conditions:

- In flat or rolling terrain, on 2H:1V or 3H:1V fill slopes and/or 2H:1V or 3H:1V cut slopes (in soils) that are 20 feet or greater in height;
- In mountainous or hilly terrain, 2H:1V or 3H:1V fill slopes and/or 2H:1V or 3H:1V cut slopes (in soils) that are 30 feet or greater in height;
- On slopes built of highly erodible soils such as sandy/loess soils in West Tennessee;
- On slopes running adjacent to a stream or adjacent to a large ditch or channel that empties directly into high-quality or sediment-impaired waters near the roadway construction;
- At point of stormwater runoff concentration where off-site runoff threatens stability of cut slopes.

On sites with flat slopes or short slope lengths, it may be possible to substitute mulch control netting or open weave textiles for erosion control blanket, based on economic considerations.

In addition to the above criteria, the designer should consider the design life of the erosion control blanket. The designer should ensure that it is possible for the permanent vegetation to become well established before the degradable portions of the blanket have degraded to the point that their resistance to erosion is significantly reduced.

**Construction Specifications** Even if properly designed, if not properly installed, erosion control blankets will likely not function as desired. Proper installation is imperative. Even if properly installed, if not properly timed and nourished, vegetation will likely not grow as desired. Proper seed/vegetation selection is also imperative.

Grade the surface of installation areas so that the ground is smooth and soil loose. When seeding prior to installation, follow the steps for seed bed preparation, soil amendments, and seeding. All gullies, rills, and any other disturbed areas must be fine graded prior to installation. Spread seed before blanket installation. **(Important:** Remove all large rocks, dirt clods, stumps, roots, grass clumps, trash, and other obstructions from the soil surface to allow for direct contact between the soil

surface and the blanket.) Terminal anchor trenches are required at blanket end. Terminal anchor trenches should be a minimum of 12 inches in depth and 6 inches in width.

**Installation for Slopes:** Place the blanket 2-3 feet over the top of the slope and into an excavated end trench measuring approximately 12 inches deep by 6 inches wide. Pin the blanket at 1 foot intervals along the bottom of the trench, backfill, and compact. Unroll the blanket down (or along) the slope maintaining direct contact between the soil and the blanket. Overlap adjacent rolls a minimum of 3 inches. Pin the blanket to the ground using staples or pins in a 3 foot center-to-center pattern or as recommended by manufacturer.

**Anchoring Devices:** 11 gauge, at least 6 inches length by 1 inch width, staples or 12 inch minimum length wooden stakes are recommended for anchoring the blanket to the ground.

Drive staples or pins so that the top of the staple or pin is flush with the ground surface. Anchor each blanket every 3 feet along its center. Longitudinal overlaps must be sufficient to accommodate a row of anchors and uniform along the entire length of overlap and anchored every 3 feet along the overlap length. Roll ends may be spliced by overlapping 1 foot (in the direction of water flow), with the upstream/upslope mat placed on top of the downstream/downslope blanket. This overlap should be anchored at 1 foot spacing across the blanket. When installing multiple width mats heat seamed in the factory, all factory seams and field overlaps should be similarly anchored.

### **Maintenance and Inspection Points**

Good contact with the ground must be maintained, and erosion must not occur beneath the blanket.

Any areas of the blanket that are damaged or not in close contact with the ground shall be repaired and stapled.

If erosion occurs due to poorly controlled drainage, the problem shall be fixed and the eroded area repaired.

Monitor and repair the blanket as necessary until ground cover is established. Inspections should include walking across the slope to check for erosion gullies that can be felt rather than seen.

### **References**

*TDOT Design Division Drainage Manual*

*TDOT Erosion Control Standard Drawing EC-STR-34*

*North Carolina Erosion and Sediment Control Planning and Design Manual*

## STABILIZATION PRACTICES

### 7.12 HYDRO APPLICATIONS



HYDRO APPLICATIONS

**Definition** A hydraulically applied mixture containing mulch, tackifiers, soil amendments and/or seed in a water based slurry, applied to slopes to establish of vegetation. Hydro applications include hydroseeding, hydromulching, and bonded fiber matrix applications.

**Purpose** To provide a method of stabilization to slopes that are often difficult to otherwise vegetate.

**Conditions Where Practice Applies** This practice is applicable on cut or fill slopes and stockpiles where surface protection is needed. Specific applications include:

- Seeding inaccessible and/or steep slopes
- Seeding stock piles
- Seeding flat slopes

**Planning Considerations** Hydro applications such as hydroseeding and bonded fiber matrices (BFM) are an economical means of applying and securing seed. Its greatest applications are on steep slopes with limited access or on flat terrain where there will be very limited sheet flows.

Hydraulic mulch applications do not provide protection on slopes generally greater than 4:1 or 5:1. Additional measures may be necessary to manage stormwater runoff and provide additional erosion control. Hydro applications should not be applied to channels and ditches.

BFM differs from general hydroseeding in that a BFM is applied at a higher rate of product (3,500-4,000 lbs/ac) and can be used on steep slopes up to 2:1. The BFM is



applied uniformly over a prepared and planted seed bed so that there are no areas where the soil surface is visible. Proper coverage provides soil stabilization and protection of the seed bed for approximately one growing season.

**Design Criteria** The following recommendations relating to design may enhance the use of, or avoid problems with the practice:

- Hydraulic applications have limited application on non-cohesive soils
- Ensure material is applied at the correct rate with the appropriate seed ratio, if applicable.

**Construction Specifications** Apply hydromulch/BFM within 24 hours of seed application. Do not apply any type of hydraulic seeding or mulching during high wind conditions or very dry conditions.

Prohibit foot, equipment and vehicle traffic across the area after application.

Hydraulic equipment and adequate water supply are necessary.

Apply the hydroseed/hydromulch/BFM uniformly leaving no visible soil. To aid in visually verifying the correct application, a dye is typically added to the mixture. To ensure the proper application rate, mark off a section on the ground, such as a 1,000 ft<sup>2</sup> area, and calibrate the sprayer to apply the correct seeding rate for 1,000 ft<sup>2</sup>.

**Maintenance and Inspection Points** Inspect slopes for rill formation. If necessary, make repairs, reseed and reapply hydraulic material.

If rilling occurs this means that slopes are too steep for hydro application. Repair the surface reseed and cover with a straw mulch to prevent erosion. Mulch should be tacked or crimped depending on the soil type.

**References** *TDOT Construction Manual*

*North Carolina Erosion and Sediment Control Planning and Design Manual*

## STABILIZATION PRACTICES

### 7.13 SOIL BINDERS



SOIL BINDERS AND TACKIFIERS

- Definition** Soil binders are a large family of products that include polyacrylamides, vegetable based products and other chemical based products that are employed as a primary short-term surface protection material.
- Purpose** To reduce soil surface erosion due to wind and/or water forces.
- Conditions Where Practice Applies** Soil binders are typically applied to disturbed areas requiring short term temporary protection. Because soil binders can often be incorporated into the work, they are a good alternative to mulches in areas where grading activities will soon resume. Soil binders are also suitable for use on stockpiles.
- Planning Considerations** Soil binders are materials that are typically used alone to provide surface protection for exposed soils. In most cases, they are not used in conjunction with seeding although they can be. In general, soil binding materials do not provide the microclimatic modification that is provided by mulches or blankets. They work by binding the upper layer of soil together, forming a crust on the surface so that soil particles resist being suspended in surface flows. Although they form a surface crust, most of the materials do not seal the surface to the point where infiltration is prevented, so they do not prevent the establishment of vegetation.
- Polyacrylamides have been used successfully to help bind cohesive soils and to reduce the suspension of fine clay particles. It is critical when using polymer based materials to use the type specified and to check carefully to be sure it is properly applied. Some polyacrylamides can be highly toxic to aquatic life if released into a water body but these are not labeled for use as soil binding materials used in erosion control.
- General Considerations**
- Regional soil types will dictate appropriate soil binders to be used.
  - A soil binder must be environmentally benign (non-toxic to plant and animal life), easy to apply, easy to maintain, economical, and should not stain paved or painted surfaces. Soil binders should not pollute stormwater.

- Some soil binders may not be compatible with existing vegetation.
- Performance of soil binders depends on temperature, humidity, and traffic across treated areas.
- Avoid over spray onto roads, sidewalks, drainage channels, existing vegetation, etc.

### Selecting a Soil Binder

Properties of common soil binders used for erosion control are provided in Table 7.13-1. Use this table to select an appropriate soil binder. Factors to consider when selecting a soil binder include the following:

- Suitability to situation – Consider where the soil binder will be applied, if it needs a high resistance to leaching or abrasion, and whether it needs to be compatible with any existing vegetation. Determine the length of time soil stabilization will be needed, and if the soil binder will be placed in an area where it will degrade rapidly. In general, slope steepness is not a discriminating factor for the listed soil binders.
- Soil types and surface materials – Fines and moisture content are key properties of surface materials. Consider a soil binder's ability to penetrate, likelihood of leaching, and ability to form a surface crust on the surface materials.
- Frequency of application – The frequency of application can be affected by subgrade conditions, surface type, climate, and maintenance schedule. Frequent applications could lead to high costs. Application frequency may be minimized if the soil binder has good penetration, low evaporation, and good longevity. Consider also that frequent application will require frequent equipment clean up.

#### *Plant-Material Based (Short Lived) Binders*

**Guar:** Guar is a non-toxic, biodegradable, natural galactomannan based hydrocolloid treated with dispersant agents for easy field mixing. It should be mixed with water at the rate of 11 to 15 lb per 1,000 gallons. Recommended minimum application rates are as follows:

#### **Application Rates for Guar Soil Stabilizer**

Slope (H:V):	Flat	4:1	3:1	2:1	1:1
lb/ac:	40	45	50	60	70

**Psyllium:** Psyllium is composed of the finely ground muciloid coating of plantago seeds that is applied as a dry powder or in a wet slurry to the surface of the soil. It dries to form a firm but rewettable membrane that binds soil particles together but permits germination and growth of seed. Psyllium requires 12 to 18 hours drying time. Application rates should be from 80 to 200 lb/acre, with enough water in solution to allow for a uniform slurry flow.

**Starch:** Starch is non-ionic, cold water soluble (pre-gelatinized) granular cornstarch. The material is mixed with water and applied at the rate of 150 lb/acre. Approximate drying time is 9 to 12 hours.

***Plant-Material Based (Long Lived) Binders***

**Pitch and Rosin Emulsion:** Generally, a non-ionic pitch and rosin emulsion has a minimum solids content of 48%. The rosin should be a minimum of 26% of the total solids content. The soil stabilizer should be non-corrosive, water dilutable emulsion that upon application cures to a water insoluble binding and cementing agent. For soil erosion control applications, the emulsion is diluted and should be applied as follows:

- For clayey soil: 5 parts water to 1 part emulsion
- For sandy soil: 10 parts water to 1 part emulsion

Application can be by water truck or hydraulic seeder with the emulsion and product mixture applied at the rate specified by the manufacturer.

***Polymeric Emulsion Blend Binders***

**Acrylic Copolymers and Polymers:** Polymeric soil stabilizers should consist of a liquid or solid polymer or copolymer with an acrylic base that contains a minimum of 55% solids. The polymeric compound should be handled and mixed in a manner that will not cause foaming or should contain an anti-foaming agent. The polymeric emulsion should not exceed its shelf life or expiration date; manufacturers should provide the expiration date. Polymeric soil stabilizer should be readily miscible in water, non-injurious to seed or animal life, non-flammable, should provide surface soil stabilization for various soil types without totally inhibiting water infiltration, and should not re-emulsify when cured. The applied compound should air cure within a maximum of 36 to 48 hours. Liquid copolymer should be diluted at a rate of 10 parts water to 1 part polymer and the mixture applied to soil at a rate of 1,175 gallons/acre or according to manufacturer specifications.

**Liquid Polymers of Methacrylates and Acrylates:** This material consists of a tackifier/sealer that is a liquid polymer of methacrylates and acrylates. It is an aqueous 100% acrylic emulsion blend of 40% solids by volume that is free from styrene, acetate, vinyl, ethoxylated surfactants or silicates. For soil stabilization applications, it is diluted with water in accordance with manufacturer's recommendations, and applied with a hydraulic seeder at the rate of 20 gallons/acre. Drying time is 12 to 18 hours after application.

**Copolymers of Sodium Acrylates and Acrylamides:** These materials are non-toxic, dry powders that are copolymers of sodium acrylate and acrylamide. They are mixed with water and applied to the soil surface for erosion control at rates that are determined by slope gradient:

Slope Gradient (H:V)	lb/acre
Flat to 5:1	3.0 – 5.0
5:1 to 3:1	5.0 – 10.0
2:2 to 1:1	10. – 20.0

**Table 7.13-1 Properties of Soil Binders for Erosion Control**  
(Source: *Ca BMP Manual*)

Evaluation Criteria	Binder Type			
	Plant Material Based (Short Lived)	Plant Material Based (Long Lived)	Polymer Emulsion Blends	Cementitious-Based Binders
Relative Cost	Low	Low	Low	Low
Resistance to Leaching	High	High	Low to Moderate	Moderate
Resistance to Abrasion	Moderate	Low	Moderate to High	Moderate to High
Longevity	Short to Medium	Medium	Medium to Long	Medium
Minimum Curing Time before Rain	9 to 18 hrs	19 to 24 hrs	0 to 24 hrs	4 to 8 hrs
Compatibility with Existing vegetation	Good	Poor	Poor	Poor
Mode of Degradation	Biodegradable	Biodegradable	Photodegradable/ Chemically Degradable	Photodegradable/ Chemically Degradable
Labor Intensive	No	No	No	No
Specialized Application Equipment	Water Truck or Hydraulic Mulcher	Water Truck or Hydraulic Mulcher	Water Truck or Hydraulic Mulcher	Water Truck or Hydraulic Mulcher
Liquid/Powder	Powder	Liquid	Liquid/Powder	Powder
Surface Crusting	Yes, but dissolves on rewetting	Yes	Yes, but dissolves on rewetting	Yes
Clean Up	Water	Water	Water	Water
Erosion Control Application Rate	Varies	Varies	Varies	4,000 to 12,000 lbs/ac

**Design Criteria** The following recommendations relating to design may enhance the use of, or avoid problems with the practice:

- Use 25 foot setbacks when applying soil binders near natural water bodies.
- Vegetable based materials have up to 6 month longevity; some polyacrylamides have as much as 12 month longevity.
- Consider that performance of binders decreases over time and exposure to ultraviolet light.
- The effectiveness of the practice decreases in concentrated flow paths.
- Excessive application can lower the infiltration rate or suspend solids in water, rather than promote settling.



**Construction Specifications** *Applying Soil Binders*

After selecting an appropriate soil binder, the untreated soil surface must be prepared before applying the soil binder. The untreated soil surface must contain sufficient moisture to assist the agent in achieving uniform distribution. In general, the following steps should be followed:

- Follow manufacturer's written recommendations for application rates, pre-wetting of application area, and cleaning of equipment after use.
- Prior to application, roughen embankment and fill areas.
- Consider the drying time for the selected soil binder and apply with sufficient time before anticipated rainfall. Soil binders should not be applied during or immediately before rainfall.
- Avoid over spray onto roads, sidewalks, drainage channels, sound walls, existing vegetation, etc.
- Soil binders should not be applied to frozen soil, areas with standing water, under freezing or rainy conditions, or when the temperature is below 40°F during the curing period.
- More than one treatment is often necessary, although the second treatment may be diluted or have a lower application rate.
- Generally, soil binders require a minimum curing time of 24 hours before they are fully effective. Refer to manufacturer's instructions for specific cure time.
- For liquid agents:
  - o Crown or slope ground to avoid ponding.
  - o Uniformly pre-wet ground at 0.03 to 0.3 gal/yd<sup>2</sup> or according to manufacturer's recommendations.
  - o Apply solution under pressure. Overlap solution 6 to 12 in.
  - o Allow treated area to cure for the time recommended by the manufacturer; typically at least 24 hours.
  - o Apply second treatment before first treatment becomes ineffective, using 50% application rate.
  - o In low humidities, reactivate chemicals by re-wetting with water at 0.1 to 0.2 gal/yd<sup>2</sup>.

The effectiveness of these products depends on rate, slope, and weather. Most will be effective until vegetation is established.

- Application rates should conform to manufacturer's guidelines for application.
- Application of binders and tackifiers should be heaviest at the edges, crests of ridges, and banks to resist wind. Binders should be applied uniformly to the remaining area.
- Use a color dye to achieve more uniform coverage.

**Maintenance and Inspection Points** Reapply soil binders to disturbed areas including high use traffic areas that interfere in the performance of this practice. If the application rate is too light reapply over the entire site. If seed application is too light or not uniform as evidenced by spotty germination, reseed the exposed areas.

**References** *TDOT Construction Manual*  
*North Carolina Erosion and Sediment Control Planning and Design Manual*  
*California Stormwater BMP Handbook*

## STABILIZATION PRACTICES

### 7.14 EMERGENCY STABILIZATION WITH PLASTIC



EMERGENCY STABILIZATION WITH PLASTIC

<b>Definition</b>	A plastic cover or sheeting used to protect stockpiles or slopes for short periods of time for immediate protection.
<b>Purpose</b>	To prevent erosion on slopes for short periods of time.
<b>Conditions Where Practice Applies</b>	<p>This practice is suitable in sheet flow applications. Specific examples include:</p> <ul style="list-style-type: none"> <li>• On stockpiles or slopes where vegetation cannot be achieved due to soils, slopes, or seasonal limitations.</li> <li>• In flood situations to prevent steep hillsides, in particular in mountainous areas, from becoming further saturated which may lead to slope failure.</li> </ul>
<b>Planning Considerations</b>	<p>Plastic sheeting is easily vandalized, easily torn, photodegradable, and must be disposed of at a landfill. While plastic sheeting can protect a slope against erosion, it results in 100% runoff, which may cause serious erosion problems in the areas receiving the increased flow.</p> <p>The use of plastic should be limited to covering stockpiles or very small graded areas for short periods of time (such as through one imminent storm event) until alternative measures, such as seeding and mulching, may be installed.</p>
<b>Design Criteria</b>	Plastic sheeting shall be polyethylene and have a minimum thickness of 6 mils.
<b>Construction Specifications</b>	<ul style="list-style-type: none"> <li>• Firmly secure the plastic at the top of the slope with sandbags or other weights placed no more than 10 feet apart.</li> <li>• Overlap and tape or weigh down seams down their entire length. The overlap should be seams at least 12 inches to 24 inches.</li> <li>• Embed edges in a minimum of 6 inches in soil.</li> </ul>

**Maintenance and Inspection Points** All sheeting must be inspected after installation and after significant rainstorms to check for erosion, undermining, and anchorage failure. Any failures must be repaired immediately. If washout or breakages occur, the material should be re-installed after repairing the damage to the slope. Watch for erosion at the end of the plastic.

**References** *TDOT Design Division Drainage Manual*  
*California Stormwater BMP Handbook*

## STABILIZATION PRACTICES

### 7.15 SOIL ENHANCEMENT



SOIL ENHANCEMENT

**Definition** Soil enhancement consists of incorporating compost within the root zone to improve soil quality, plant viability and soil hydraulic conductivity.

**Purpose** Naturally occurring (undisturbed) soil and vegetation provide important stormwater functions including:

- water infiltration;
- nutrient, sediment, and pollutant adsorption;
- sediment and pollutant biofiltration;
- water interflow storage and transmission; and
- pollutant decomposition.

The primary soil impact from construction is compaction. Compaction impacts relate to a change in soil porosity. Bulk density is an indicator of soil compaction. As bulk density increases, soil porosity decreases as does a soil's capacity for water infiltration and storage, and plant root penetration and growth. The result of compaction is poor vegetative vigor. Generally this occurs as bulk densities reach 99 lbs./ft<sup>3</sup> (1.58g/cm<sup>3</sup>).

Soil functions are largely lost when development strips away native soil and vegetation and replaces it with minimal topsoil and seed or sod. Not only are these important stormwater functions lost, but the landscapes themselves become pollution-generating pervious surfaces due to increased use of pesticides, fertilizers and other landscaping and household/industrial chemicals, the concentration of pet wastes, and pollutants that accompany roadside litter.

Establishing soil quality and depth regains greater stormwater functions in the post development landscape. This provides increased treatment of pollutants and sediments that result from development and habitation, and minimizes the need for some landscaping chemicals, thus reducing pollution through prevention.

Establishing a minimum soil quality and depth is not the same as preservation of naturally occurring soil and vegetation. However, establishing a minimum soil



quality and depth will provide improved onsite management of stormwater flow and water quality.

Soil organic matter can be attained through numerous materials such as compost, composted woody material, biosolids, and forest product residuals. It is important that the materials used to meet the soil quality and depth be appropriate and beneficial to the plant cover to be established. Likewise, it is important that imported topsoils improve soil conditions and do not have an excessive percent of clay fines.

**Conditions  
Where Practice  
Applies**

At any construction site using vegetation as a component of the overall stabilization plan.

**Planning  
Considerations**

Prior to beginning work on the construction site, identify sources of soil enhancement materials, such as compost.

**Design Criteria**

**Soil retention.** The native topsoil should be retained onsite (see Section 7.3 Topsoiling) to the maximum extent practicable. In any areas requiring grading, remove and stockpile topsoil on site in a designated, controlled area, not adjacent to water resources and critical areas, to be reapplied to other portions of the site where feasible.

**Soil quality.** All areas subject to clearing and grading that have not been covered by impervious surface, incorporated into a drainage facility or engineered as structural fill or slope shall, at project completion, demonstrate the following:

1. A topsoil layer with a minimum organic matter content of 10% dry weight in planting beds, and 5% organic matter content in turf areas, and a pH from 6.0 to 8.0 or matching the pH of the original undisturbed soil. The topsoil layer shall have a minimum depth of eight inches except where tree roots limit the depth of incorporation of amendments needed to meet the criteria. Subsoils below the topsoil layer should be scarified at least 4 inches with some incorporation of the upper material to avoid stratified layers, where feasible.
2. Planting beds must be mulched with 2 inches of organic material.
3. Quality of compost and other materials used to meet the organic content requirements:
  - a) The compost must have an organic matter content of 35% to 65%, and a carbon to nitrogen ratio below 25:1.
  - b) Calculated amendment rates may be met through use of composted materials as defined above.
  - c) The resulting soil should be conducive to the type of vegetation to be established.

**Construction Specifications**

The soil quality design guidelines listed above can be met by using one of the methods listed below:

- 1) Leave undisturbed native vegetation and soil, and protect from compaction during construction.
- 2) Amend existing site topsoil or subsoil either at default “pre-approved” rates, or at custom calculated rates based on specifiers tests of the soil and amendment.
- 3) Stockpile existing topsoil during grading, and replace it prior to planting. Stockpiled topsoil must also be amended if needed to meet the organic matter or depth requirements, either at a default “pre-approved” rate or at a custom calculated rate.
- 4) Import topsoil mix of sufficient organic content and depth to meet the requirements. More than one method may be used on different portions of the same site. Soil that already meets the depth and organic matter quality standards, and is not compacted, does not need to be amended.

**Maintenance and Inspection Points**

Soil quality and depth should be established toward the end of construction and once established, should be protected from compaction, such as from large machinery use, and from erosion.

Soil should be planted and mulched after installation.

Plant debris or its equivalent should be left on the soil surface to replenish organic matter.

It should be possible to reduce use of irrigation, fertilizers, herbicides and pesticides. These activities should be adjusted where possible, rather than continuing to implement formerly established practices.

**References**

*TDOT Design Division Drainage Manual*  
*Stormwater Management Manual for Western Washington*

## POLLUTION PREVENTION

### 7.16 CONCRETE WASHOUT



CONCRETE WASHOUT

- Definition** A designated area where concrete wash can harden, can be broken up, and can then be placed in the dumpster or backfilled.
- Purpose** To prevent or reduce the discharge of pollutants to stormwater from concrete waste by conducting washout offsite or performing onsite washout in a designated area.
- Conditions Where Practice Applies** Concrete washout areas are applicable where:
- Concrete trucks and other concrete-coated equipment are washed onsite.
  - Slurries containing portland cement concrete or asphalt concrete are generated, such as from saw cutting, coring, grinding, grooving, and hydro-concrete demolition.
  - Washing of exposed aggregate concrete.
  - Building or house construction mortar mixer waste
- Planning Considerations** There are two main types of concrete washouts to be considered, prefabricated washout containers and site-built washouts.

#### PREFABRICATED WASHOUT CONTAINERS

Many private companies offer heavy-duty, prefabricated concrete washout containers that are delivered to the site. Some services provide only the containers while others also provide the maintenance and disposal of the materials. Utilizing full-service concrete washout companies removes much of the burden from the jobsite superintendent and tends to result in a more maintained washout facility. When selecting a company to handle concrete waste, ensure that they are properly disposing of all materials. If the project utilizes a concrete pump truck, the prefabricated container should have an adequate ramp to accommodate the concrete pump truck.

## SITE-BUILT WASHOUTS

There are many design options for the site-built washout, but preference should be given to those built below-grade to prevent breaches and reduce the likelihood of runoff. Above-grade structure can also be used if they are sized properly to avoid spillage, constructed properly to prevent leaks, and diligently maintained.

An important factor that dictates the success of concrete washout facilities is whether or not concrete truck drivers and subcontractors are educated on the use of the washout facilities. The site superintendent should educate all appropriate parties on proper use of concrete washout facilities. Signs should be posted indicating the location and designated use of the facilities.

**Design Criteria** When using prefabricated washout containers, ensure containers can withstand heavy impacts and are watertight.

Site-built washouts should be constructed by providing a temporary pit or bermed area sized large enough to handle solids, wash slurry, and rainfall to prevent overflow and include a minimum of 4" freeboard. Above-grade washouts should allow adequate at least 4" of freeboard for structural stability of berms or containment walls. The temporary pit containing dry waste concrete may be incorporated into fill areas as needed. The waste concrete may be broken into smaller pieces to allow proper soil compaction. The storage area should be lined with geotextile fabric to allow water to infiltrate, further aiding the dewatering and drying process.

Consideration should be given to locating washout facilities. The designer should included suggested concrete washout areas on all applicable SWPPPs. Each facility should be located conveniently for concrete trucks, preferably near the area where concrete is being poured, and away from heavy volume construction traffic or access areas to prevent disturbance or tracking. Facilities should also be located a minimum of 50 feet away from storm drains, open ditches, and waterbodies. Appropriate gravel or rock should cover paths to concrete washout facilities if the facilities are located in undeveloped areas.

On large sites with extensive concrete work, concrete washouts should be located in multiple areas for ease of use.

### Construction Specifications

- The storage pit area should be lined with a permeable geotextile fabric.
- Do not allow runoff from the storage area. Construct a temporary pit or bermed area large enough to contain anticipated slurry amount, solid waste, and direct rainwater.
- Wash out wastes into the temporary pit where the concrete can set, be broken up, and then disposed properly.
- Avoid creating runoff by draining water to a bermed or level area when washing concrete to remove fine particles and expose the aggregate.

**Maintenance  
and Inspection  
Points**

Ensure contractors avoid mixing excess amounts of fresh concrete and perform washout of concrete trucks offsite or in designated areas only. Do not allow concrete trucks to wash into storm drains, open ditches, streets, or streams. Do not allow excess concrete to be dumped onsite, except in designated areas. Do not wash sweepings from exposed aggregate concrete into the street or storm drains.

Temporary concrete washout facilities should be maintained to provide adequate holding capacity with a minimum freeboard of 4 inches for above grade facilities and 12 inches for below grade facilities. Inspect plastic linings and sidewalls of site-built washouts to ensure they have not been damaged during construction activities. Inspect all surfaces of prefabricated washouts to ensure the container is not leaking.

Washout facilities must be cleaned, or new facilities must be constructed and ready for use once the washout is 75% full.

Inspectors should note whether washout facilities are being used and maintained regularly. If inspector finds that concrete trucks are being washed out in locations other than designated washout areas, the inspector should notify the site superintendent immediately and the site superintendent should correct the issue.

**References**

*California Stormwater BMP Handbook*

*City of Knoxville Best Management Practices Manual*

*Hamilton County, TN BMP Manual*

*EPA National Pollutant Discharge Elimination System Concrete Washout*



## POLLUTION PREVENTION

### 7.17 VEHICLE MAINTENANCE

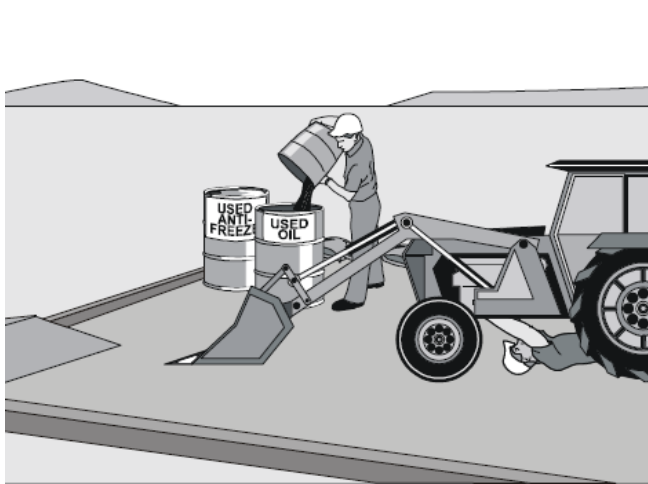

VEHICLE MAINTENANCE

**Definition** Procedures and practices to reduce the discharge of pollutants to storm drain systems, or to watercourses as a result of vehicle and equipment maintenance.

**Purpose** To prevent or reduce the contamination of stormwater resulting from vehicle and equipment maintenance.

**Conditions Where Practice Applies** These procedures are suitable on all construction projects where heavy equipment and vehicles are maintained onsite.

**Planning Considerations** Outdoor vehicle or equipment maintenance is a potentially significant source of stormwater pollution. Activities that can contaminate stormwater include engine repair and service, changing or replacement of fluids, equipment fueling, and outdoor equipment storage and parking (engine fluid leaks).

Onsite vehicle and equipment maintenance should only be used where it is impractical to send vehicles and equipment offsite for maintenance and repair.

**Design Criteria** There is no formal design for this measure. However, the following requirements may affect your site design and SWPPP:

Locate maintenance areas where they are protected from stormwater run-on and runoff and at least 50 feet from downstream drainage facilities and watercourses. Dedicated maintenance areas should be covered and paved wherever practical. Washing and maintenance areas should be properly contained, and liquids should be treated before discharging. Utilizing a municipal sanitary sewer system may be practical, but proper coordination and permitting should be obtained before doing so.

Develop a spill prevention and cleanup plan and provide to maintenance personnel. The site superintendent should educate workers on the spill prevention and cleanup procedures.

**Construction Specifications**

Inspect construction equipment for leaks daily, and repair immediately. Soil staining under or near equipment could be evidence of equipment leaks. Recycle or properly dispose of used oils, antifreeze, solvents, and automotive-related chemicals. Maintain drip pans, absorbent materials and covered trash receptacles in maintenance areas to dispose of spills and leakage. Place a stockpile of spill cleanup materials where it will be readily accessible.

Use vacuums or blowers instead of water to remove dry material from equipment and vehicles whenever possible. Utilize high-pressure water alone for washing instead of detergents whenever possible.

Use offsite repair shops as much as possible. These businesses are better equipped to handle vehicle fluids and spills properly. Performing this work offsite can also be economical by eliminating the need for a separate maintenance area.

If maintenance must occur onsite, use designated areas located away from drainage courses and stream buffer zones.

Drip pans or absorbent pads should be used during vehicle and equipment maintenance work that involves fluids. All fueling trucks and fueling areas are required to have spill kits and/or use other spill protection devices. Use adsorbent materials on small spills. Remove the absorbent materials after using and dispose of properly.

Segregate and recycle wastes, such as greases, used oil or oil filters, antifreeze, cleaning solutions, automotive batteries, hydraulic and transmission fluids. Provide secondary containment and covers for these materials if stored onsite.

Do not place used oil in a dumpster or pour on ground or into a storm drain or watercourse.

Properly dispose of or recycle used batteries.

**Maintenance and Inspection Points**

Vehicles and equipment should be inspected on each day of use. Leaks should be repaired immediately or the problem vehicle(s) or equipment should be removed from the project site.

Keep ample supplies of spill cleanup materials onsite.

**References**

*Hamilton County BMP Manual*

## 7.18 CHEMICAL STORAGE



CHEMICAL  
STORAGE

CHEMICAL STORAGE

**Definition** A designated storage area equipped to minimize the risk stormwater pollution of storing chemicals on a construction site.

**Purpose** To prevent, reduce, or eliminate the discharge of pollutants from material storage to the stormwater system or watercourses by minimizing the storage of materials onsite, storing materials kept on site in a designated area, installing secondary containment, conducting regular inspections, and training employees and subcontractors.

**Conditions  
Where Practice  
Applies**

This practice is applicable for storage of the following materials:

- Soil stabilizers and binders
- Pesticides and herbicides
- Fertilizers
- Detergents
- Plaster
- Petroleum products such as fuel, oil, and grease
- Asphalt and concrete components
- Hazardous chemicals such as acids, lime, glues, adhesives, paints, solvents, and curing compounds
- Concrete compounds
- Other materials that may be detrimental if released to the environment.

**Planning  
Considerations**

Space limitation may preclude indoor storage.

Storage sheds often must meet building and fire code requirements.

Storage areas should not be located near wetlands, streams and other sensitive features.

**Design Criteria** There is no formal design for this measure. However, the following requirements may affect your site design and SWPPP:

All chemicals must be stored in covered areas or with containment systems constructed in or around the storage areas. These areas should also be designed for easy access for materials delivery and storage. Show storage areas on the SWPPP and site development plans. Locate temporary storage areas away from high volume vehicular traffic and waterways. Ensure that the site has an accessible 55-gal drum (or similar) container to receive and contain small spill amounts and resulting cleanup materials.

Storage of reactive, ignitable, or flammable liquids must comply with the fire codes of your area.

**Construction Specifications** Do not store chemicals, drums, or bagged materials directly on the ground. Place these items on a pallet and in secondary containment. Whenever possible, store materials in a covered area and within secondary containment such as an earthen dike or prefabricated storage unit. If drums must be kept uncovered, store them at a slight angle to reduce ponding of rainwater on the lids to reduce corrosion. Domed plastic covers are inexpensive and snap to the top of drums, preventing water from collecting.

Chemicals should be kept in their original labeled containers.

If significant residual materials remain on the ground after construction is complete, properly remove materials and any contaminated soil. If the area is to be paved, pave as soon as materials are removed to stabilize the soil.

**Maintenance and Inspection Points** Keep an up-to-date inventory of materials stored onsite.

Contain and clean up any spill immediately. Dispose of chemicals and materials used for cleaning up after use. Include emergency contact information for spills, such as the local emergency management agency contact information. This spill response information should be prominently displayed. Contact TDEC Water Pollution Control's EFO in the event that a chemical spill reaches a stream or wetland or exceeds 50 gallons.

Keep storage areas clean, well organized, and equipped with ample cleanup supplies as appropriate for the materials being stored.

Repair or replace perimeter controls, containment structures, covers, and liners as needed to maintain proper function.

**References** *California Stormwater BMP Handbook*  
*Hamilton County BMP Manual*  
*Knox County BMP Manual*

## POLLUTION PREVENTION

### 7.19 TRASH AND DEBRIS MANAGEMENT

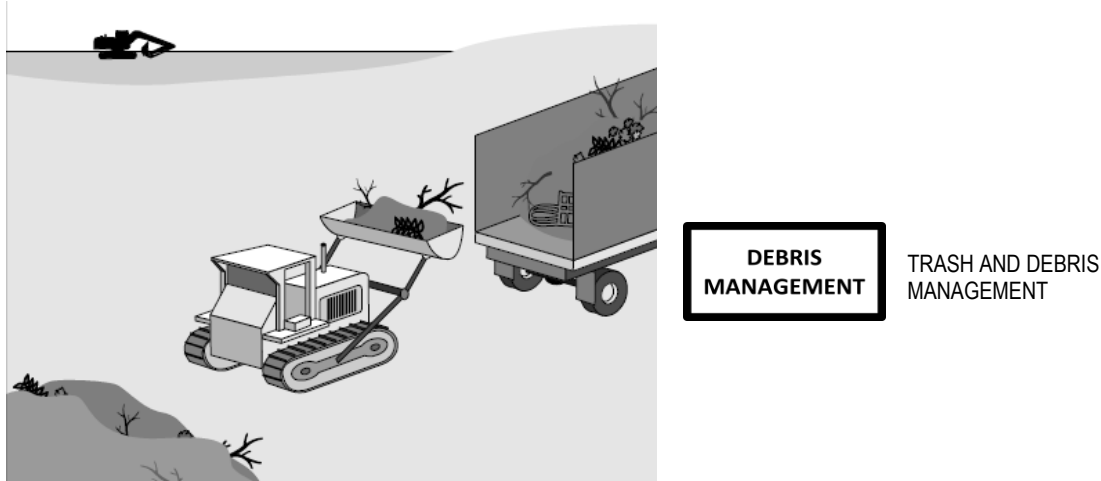

**Definition** The management of waste materials and debris on the construction site.

**Purpose** To prevent or reduce the discharge of pollutants to stormwater from solid or construction waste by providing designated waste collection areas and containers, and arranging for regular disposal.

**Conditions Where Practice Applies** This practice is applicable when the following items may be found on the construction site:

- Waste generated from trees and shrubs removed during land clearing, demolition of existing structures (rubble), and building construction.
- Packaging materials including wood, paper, and plastic.
- Scrap or surplus building materials including scrap metals, rubber, plastic, glass pieces and masonry products.
- Domestic wastes including food containers such as beverage cans, coffee cups, paper bags, plastic wrappers, and cigarettes.
- Construction wastes including brick, mortar, timber, steel and metal scraps, pipe and electrical cuttings, non-hazardous equipment parts, Styrofoam and other materials used to transport and package construction materials.
- Construction crew sanitary waste management facilities.

**Planning Considerations** All construction trash and debris must be properly collected and managed for proper offsite disposal. A debris storage area should be included on the SWPPP when the materials noted above will be encountered on the project.

Consider using onsite ground trees and brush as mulch. Identify other recyclable materials, and keep them sorted for easy removal.



- Design Criteria** Select designated waste collection areas onsite. These areas should be located well away from sensitive site features such as streams, wetlands, and sinkholes.
- Locate containers in an easily accessible area and post signage designating waste disposal areas if needed. Provide enclosed containers or locate containers in covered areas to prevent direct rainwater contact or loss of waste due to wind. If using large containers, ensure they have lids to prevent rain from mixing with the debris and trash.
- Make sure that toxic liquid wastes (used oils, solvents, and paints) and chemicals (acids, pesticides, additives, curing compounds) are not disposed of in dumpsters designated for construction debris. Post signage and provide worker education related to items that should not be disposed of in municipal waste and construction debris containers.
- Construction Specifications** Do not hose out dumpsters on the construction site. Dumpster cleaning should be taken care of by the solid waste management company providing the containers. Do not allow solid waste management workers to clean their containers on the construction site.
- Arrange for regular waste collection before containers overflow.
- Stormwater runoff should be prevented from contacting stored waste through the use of berms, dikes, or other temporary diversion structures or through the use of measures to elevate waste from site surfaces.
- Waste storage areas should be located at least 50 feet from drainage facilities and watercourses and should not be located in areas prone to flooding or ponding or in the stream buffer zone.
- Clean up immediately if a container does spill.
- Ensure that construction debris and trash are not being used as fill onsite unless approved by the local municipality and TDEC.
- Maintenance and Inspection Points** Inspect the site for evidence of trash and construction debris being placed outside of the designated trash and debris collection area. Make sure that construction waste is collected, removed, and disposed of only at authorized disposal areas. Contractors should ensure all waste and debris is removed from construction site after construction is completed before leaving.
- To prevent clogging of the storm drainage system, litter and debris removal from drainage grates, trash racks, and ditch lines should be a priority.
- Litter from work areas within the construction limits of the project site should be collected and placed in watertight dumpsters before a rain event, regardless of whether the litter was generated by the contractor, the public, or others. Collected litter and debris should not be placed in or next to drain inlets, stormwater drainage systems, or watercourses.
- Inspect trash and debris collection areas after wind and/or rain events to ensure that they are keeping the trash and debris contained.
- References** *California Stormwater BMP Handbook*

## RUNOFF CONTROL AND MANAGEMENT

This section contains measures that are permanent or temporary. They are designed to convey storm water runoff non-erosively. Rip rap is a material incorporated into many of the management practices. The following rip rap classes and stone sizes apply to measures throughout this manual:

**Table 7.20-1 TDOT Rip Rap Classification and Sizes**

<b>TDOT Classification</b>	<b>D<sub>50</sub> Stone Size (inches)</b>	<b>Overall Stone Sizes (inches)</b>	<b>Placement Depth</b>
Class A-1	9	2 – 15	18 inches
Class A-3	4	2 – 6	As noted on plans
Class B	15	3 – 27	2.5 feet
Class C	20	5 – 36	3.5 feet

## 7.20 CHECK DAM



**Definition** A small temporary barrier, grade control structure or dam constructed across a swale, drainage ditch, or area of concentrated flow.

**Purpose** To minimize the erosion rate by reducing the velocity of stormwater in areas of concentrated flow. While check dams are primarily erosion control devices, they provide limited sediment control by slowing velocities and ponding runoff. Note that wattles and tubes installed as check dams are addressed in Section 7.25.

**Conditions Where Practice Applies** This practice is applicable for use in ditches and small open channels and **is not to be used in a stream**. Specific applications include:

- Temporary or permanent swales or ditches in need of protection during establishment of grass linings.
- Temporary or permanent swales or ditches that, due to their short length of service or for other reasons, cannot receive a permanent non-erodible lining for an extended period of time.
- Other locations where small localized erosion and sedimentation problems exist in areas of concentrated flow.

**Planning Considerations** Check dams are an expedient way to reduce gullying in the bottom of channels that will be filled or stabilized at a later date. The dams should only be used while permanent stabilization measures are being put into place.

Check dams installed in grass-lined channels may kill the vegetative lining if submergence after it rains is too long and/or silting is excessive. All stone and riprap must be removed if mowing is planned as part of vegetative maintenance.

The main function of a check dam is to decrease velocity, not to collect sediment, although sediment capture is an added benefit.

**Design Criteria** The channel and check dam must be designed to adequately convey the design storm for the associated drainage area.

**Spacing:** Maximum spacing between dams should be such that the toe of the upstream dam is at the same elevation as the top of the downstream dam. Two or more check dams in series should be used when the drainage area exceeds the limitation for one dam.

**Height:** The height of the check dam from the bottom of the channel to the bottom of the weir should be a minimum of 1 foot above the ditch bottom.

**Weir:** The depth of flow on the center of the structure (weir) shall be computed for the peak flow rate generated by the 2-year, 24-hour storm in order to ensure that the top of the structure will not be overtopped. For sites draining to high quality streams or streams listed as impaired by sediment, the depth must be determined for the 5-year, 24-hour peak flow rate. The weir must be at least 9 inches deep.

**Side Slopes:** The side slopes should be 2:1 or flatter.

**Materials:** A geotextile should be used as a separator between the graded stone and the soil base and abutments. The geotextile will prevent the migration of soil particles from the subgrade into the graded stone. Geotextiles should be “set” into the subgrade soils. The geotextile should be placed immediately adjacent to the subgrade without any voids and extend three feet beyond the downstream toe of the dam to prevent scour.

### **Construction Specifications**

- Rock check dams should be constructed out of machined riprap, Class A-1 (see Table 7.20-1 for stone size and  $d_{50}$ ).
- Place stone to the lines and dimensions shown in the plan on a filter fabric foundation.
- Keep the center stone section at least 9 inches below natural ground level where the dam abuts the channel banks.
- Set spacing between dams to assure that the elevation at the top of weir section of the lower dam is the same as the toe elevation of the upper dam.
- Extend geotextile fabric 3 feet down gradient from the toe of the check dam to prevent scour at the toe.
- Protect the channel after the lowest check dam from heavy flow that could cause erosion.
- Ensure that the channel reach above the most upstream dam is stable.
- Ensure that other areas of the channel, such as culvert entrances below the check dams, are not subject to damage or blockage from displaced stones.

**Maintenance and Inspection Points**

Sediment should be removed before it reaches a depth of one-half the original dam height.

Add rock as needed to maintain design height and cross section.

If the area is to be mowed, check dams must be removed once final stabilization has occurred. After removal, the disturbed area should be seeded and mulched immediately.

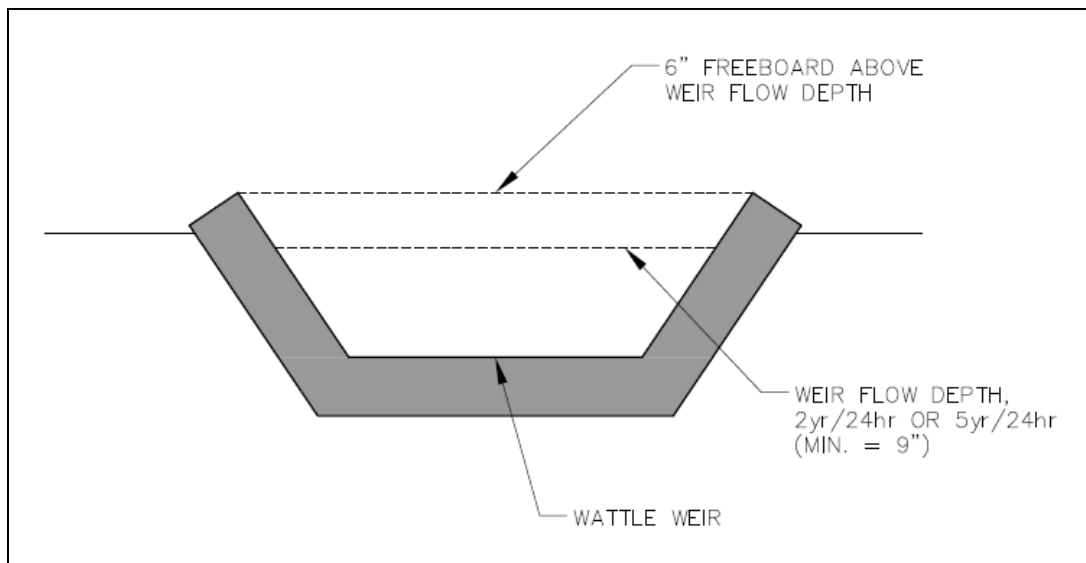

**Figure 7.20-1. Wattle Check Dam**

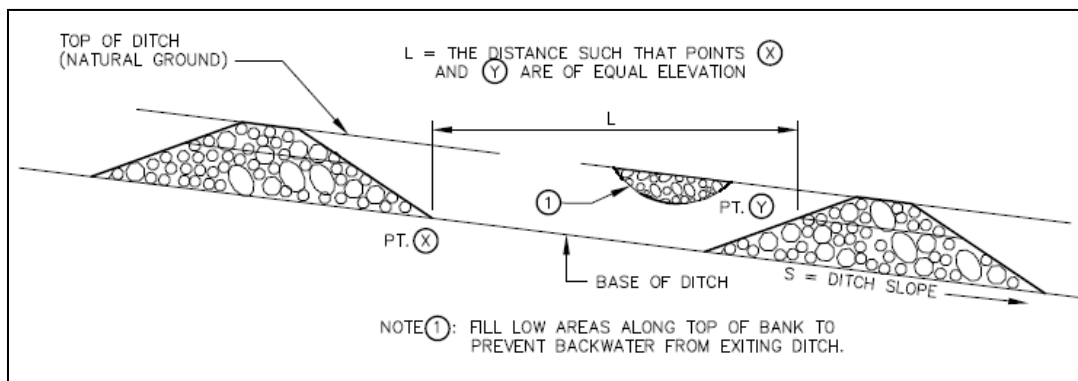

**Figure 7.20-2 Spacing between check dams (Source: TDOT)**

**References**

- TDOT Design Division Drainage Manual*
- TDOT Erosion Control Standard Drawing EC-STR-6*
- North Carolina Erosion and Sediment Control Planning and Design Manual*



## RUNOFF CONTROL AND MANAGEMENT

### 7.21 DEWATERING TREATMENT PRACTICES

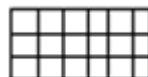

DEWATERING STRUCTURE

**Definition** A temporary sediment control structure that combines riprap and geotextile fabric to settle and/or filter sediment laden water which has been pumped from an excavated work area.

**Purpose** To settle and filter sediment-laden water prior to the water being discharged off-site.

**Conditions Where Practice Applies** Wherever sediment-laden water must be removed from a construction activity by means of pumping.

**Planning Considerations** Water that is pumped from a construction site usually contains a large amount of sediment. A dewatering structure is typically needed to remove the sediment before water is released off-site. One of several types of dewatering structures may be constructed depending upon site conditions and type of operation. A well stabilized, onsite, vegetated area may serve as a dewatering device if the area is stabilized so that it can filter sediment and at the same time withstand the velocity of the discharged water without eroding. The discharge of sediment-laden water onto a vegetated area should not pose a threat to the survival of the existing vegetative stand through smothering by sedimentation. Where a grass filter strip alone is to be used to filter pumped water, a minimum filtering length of **75 feet** must be available in order for such a method to be feasible. Regardless, the runoff must not cause a water quality violation where it enters a stream or wetland.

Dewatering structures should not be placed within a jurisdictional wetland, stream buffer or within 20 feet of a stabilized outlet, stream, or other natural water resource.

**Design Criteria** A dewatering structure must be sized (and operated) to allow pumped water to flow through the filtering device without overtopping the structure. An excavated basin may be lined with geotextile to help reduce scour and to prevent the inclusion of soil from within the structure.

The minimum required volume of storage in cubic feet for a dewatering structure is obtained by multiplying the pumping rate (in gallons per minute) by 16. The recommended volume is based on 2 hours of pumping at the full rate shown on the drawing. In situations where it is likely that a pump will be operated for longer periods of time, the volume of the structure should be appropriately increased. Where the structure is to be placed in a sloping area, the available storage capacity will be reduced. It may be necessary to increase the size of the structure to compensate for this.

**Construction Specifications** **Portable Sediment Tank:**

**Materials:** The sediment tank may be constructed with steel drums, sturdy wood or other material suitable for handling the pressure exerted by the volume of water. The structure should have a minimum depth of two feet.

**Location:** The location for the sediment tank should be chosen for easy clean-out and disposal of the trapped sediment, and to minimize the interference with construction activities.

**Storage Volume:** The following formula should be used to determine the storage volume of the sediment tank:

$$\text{Pump discharge (gpm)} \times 16 = \text{cubic feet of storage required}$$

**Operation:** Once the water level nears the top of the tank, **the pump must be shut off** while the tank drains and additional capacity is made available. The tank should be designed to allow for emergency flow over the top of the tank. Clean-out of the tank is required once one-third of the original capacity is depleted due to sediment accumulation. The tank should be clearly marked showing the clean-out point.

**Straw Bale/Silt Fence Pit:**

**Materials:** The straw bale/silt fence pit should consist of straw bales, silt fence, washed stone (TDOT size 57) and an optional excavated wet storage pit.

**Storage Volume:** The following formula should be used to determine the storage volume of the straw bale/silt fence pit:

$$\text{Pump discharge (gpm)} \times 16 = \text{cubic feet of storage required}$$

In calculating the capacity, include the volume available from the floor of the excavation to the top of the structure. Excavation may not be necessary to obtain the necessary storage volume.

**Operation:** Once the water level nears the top of the straw bales, **the pump must be shut off** while the structure drains down to at least half of the storage volume. Overtopping the dewatering structure is not allowed. If turbidity is not adequately addressed through the silt fence material, straw bales and washed stone, additional treatment must be considered. When the excavated area becomes filled to one-half of the excavated depth, accumulated sediment should be removed and properly disposed of.

**Sediment Filter Bag:**

**Materials:** The filter bag should be constructed of non-woven geotextile material that will provide adequate filtering ability to capture the larger soil particles from the pumped water. The bag should be constructed so that there is an inlet neck that may be clamped around the dewatering pump discharge hose so that all of the pumped water passes through the bag.

**Location:** A temporary sediment filter bag may be used whenever sediment laden water is removed from an area by means of pumping and where there is insufficient room to use a temporary dewatering structure. A temporary sediment filter bag should not be placed within a jurisdictional wetland, a stream buffer, or within 20 feet of a stabilized outlet, stream or ditch line. A filled sediment bag can weigh as much as 7 tons. The designer should ensure that there will be adequate access for the equipment necessary for the disposal of the bag.

**Design:** A temporary sediment filter bag should be placed on a level pad a minimum of 6 inches thick composed of mineral aggregate (size 57). This pad should be constructed on an area with sufficient slope to allow water entering the pad to drain away from the project work area. However, it is necessary for the pad to be level in order to prevent the bag from rolling along the slope as water is pumped into the structure. The upper surface of the pad, including the slopes, should be lined with geotextile fabric. In addition, it should be separated from the existing ground by a layer of polyethylene sheeting. Off-site stormwater runoff should be diverted around the temporary dewatering filter bag location. The capacity of the sediment filter bag should be adequate to handle the dewatering pump discharge and should be based upon the manufacturer's recommendation on pump sizing. Failure to correlate the pump capacity and the bag capacity can result in failure of the bag. The filter bag must be equipped with a sleeve to receive the pump hose. Slitting the bag to make the hose connection is not acceptable.

**Storage Volume:** The capacity of the sediment filter bag should be adequate to handle the dewatering pump discharge, and should be based on the bag manufacturer's recommendation and expected sediment volume.

**Operation:** Pumping into the bag can only occur when being supervised. Unsupervised pumping is not allowed. Discharge from the filter bag cannot cause an objectionable color contrast with the receiving stream. Additional treatment may be necessary if an objectionable color contrast is observed.

**Disposal:** In determining the location for a proposed sediment filter bag, the designer should allow sufficient room and a clear path to allow access for the equipment needed for bag removal. When the filter bag has accumulated a 6inch depth of sediment, it should be removed and replaced with a new filter bag.

**Maintenance  
and Inspection  
Points**

The filtering devices must be inspected frequently and repaired or replaced once the sediment build-up prevents the structure from functioning as designed. The accumulated sediment which is removed from a dewatering device must be spread on-site and stabilized or disposed of at an approved disposal site as per the SWPPP.

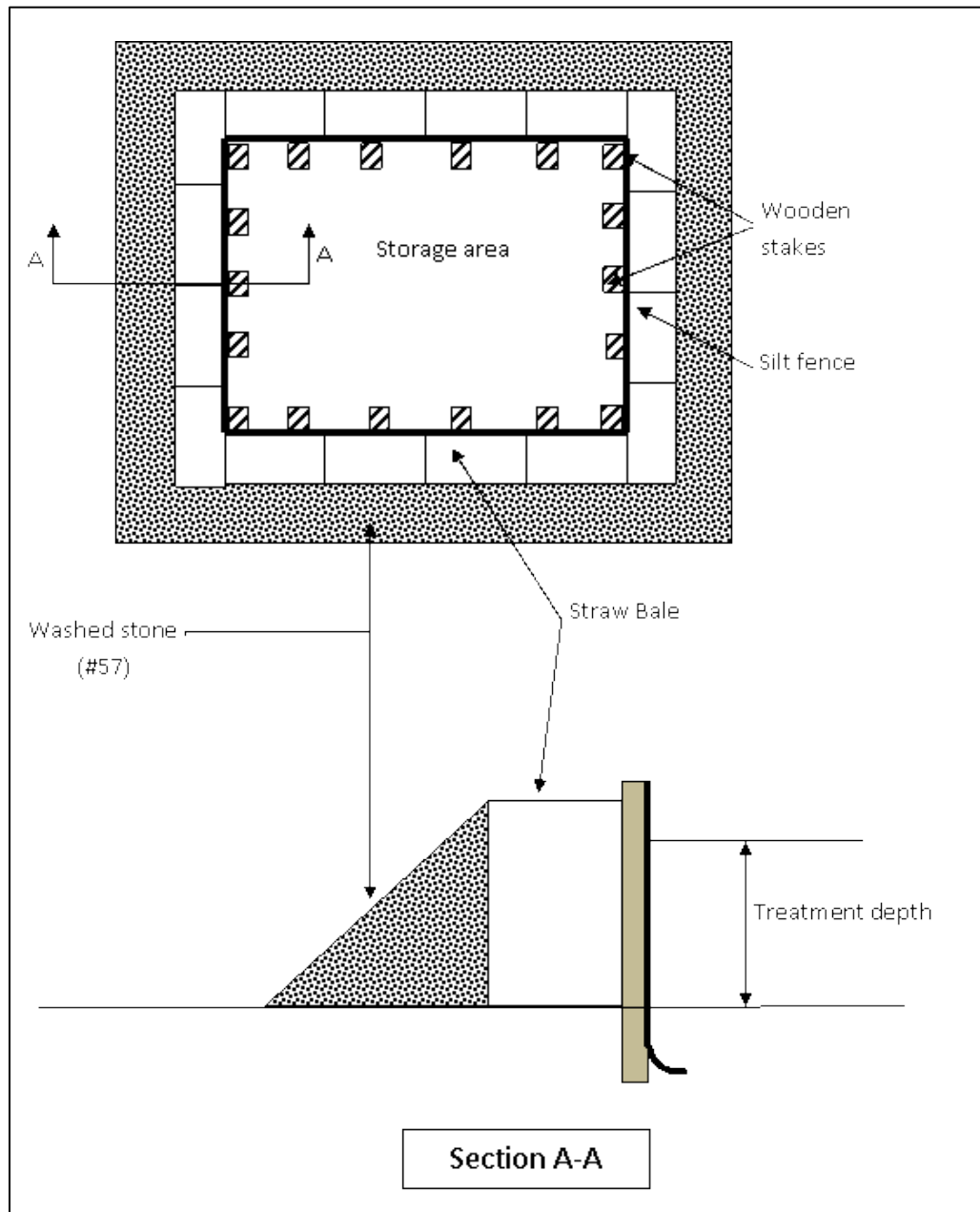

Figure 7.21-1 Silt fence and straw bale dewatering pit

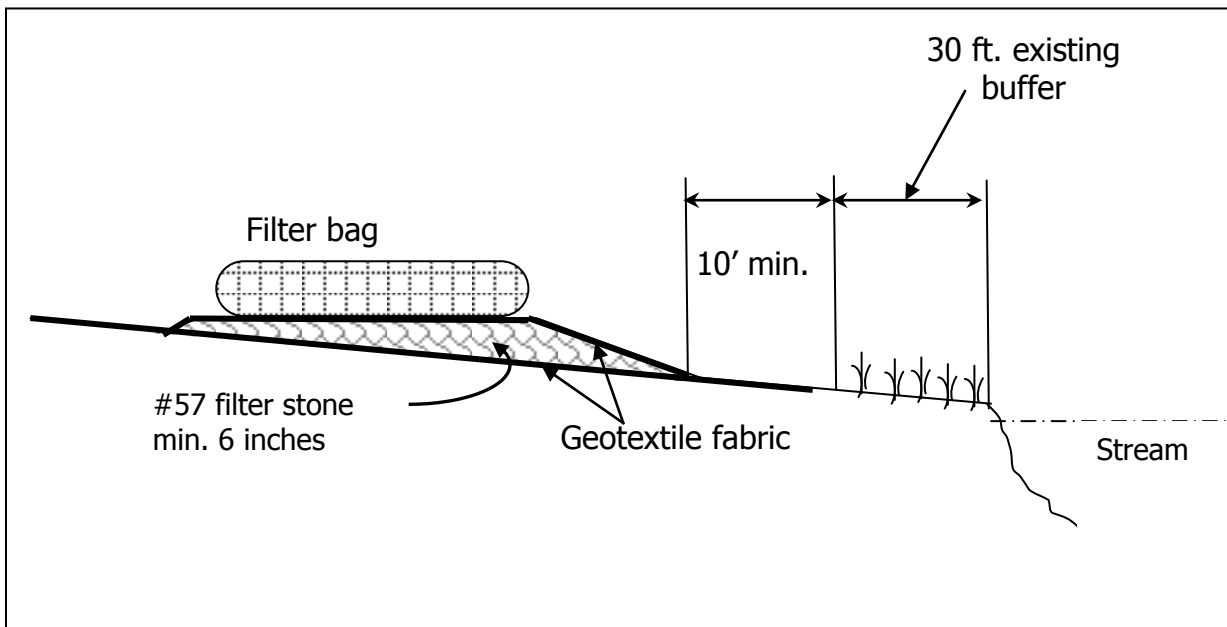

Figure 7.21-2 Sediment filter bag

- References** *TDOT Design Division Drainage Manual*  
*TDOT Erosion Control Standard Drawing EC-STR-1*  
*North Carolina Erosion and Sediment Control Planning and Design Manual*



## RUNOFF CONTROL AND MANAGEMENT

### 7.22 DIVERSION



→ TD → DIVERSION

**Definition** A temporary ridge or excavated channel or combination ridge and channel constructed across sloping land on a predetermined grade.

**Purpose** To reduce the erosion of steep, or otherwise, highly erodible areas by reducing slope lengths, intercepting storm runoff and diverting it to a stable outlet at a non-erosive velocity, or to convey storm water through a construction site. Stream diversions are covered in Section 7.43.

**Conditions Where Practice Applies** This practice applies to construction areas where runoff can be diverted and disposed of properly to control erosion, sedimentation, or flood damage. Specific locations and conditions include:

- Where the slope length needs to be reduced to minimize erosion.
- Where runoff from upslope areas is, or has the potential for, damaging property, flooding or preventing the establishment of vegetation on lower areas.
- When clean stormwater is coming onto the site and needs to be conveyed across or around the disturbed area to prevent contamination.
- Where excess runoff needs to be diverted to stabilized outlets.
- Where sediment laden water needs to be directed to sediment traps.
- At or near the perimeter of construction areas to prevent sediment from leaving the site.

**Planning Considerations** It is important that diversions are properly designed, constructed and maintained since they concentrate water flow and increase erosion potential. Particular care must be taken in planning diversion grades. Too much slope can result in erosive velocity in the diversion channel or at the outlet. A change of slope from steeper grade to flatter may cause deposition to occur. The deposition reduces carrying capacity, and may cause overtopping and failure. Frequent inspection and timely maintenance are essential to the proper functioning of diversions.

Sufficient area must be available to construct and properly maintain diversions. It is usually less costly to excavate a channel and form a ridge or dike on the downhill side with the spoil than to build diversions by other methods. Where space is limited, it may be necessary to build the ridge by hauling in diking material, or using a silt fence to divert the flow. Use gravel to form the diversion dike when vehicles must cross frequently.

Plan temporary diversions to function 1 year or more, or they may be constructed anew at the end of each day's grading operation to protect new fill. Diversions that are to serve longer than 30 working days should be seeded and mulched as soon as they are constructed to preserve dike height and reduce maintenance.

A channel lining should be used to prevent erosion. Channels using rock linings should be undercut to account for the rock thickness to preserve the required flow depth.

Temporary diversions may serve as in-place sediment traps if over-excavated 1 to 2 feet and placed on a nearly flat grade. The dike serves to divert water as the stage increases. A combination of silt fence and channel diversion – where fill from the channel is used to stabilize the fence – can trap sediment and divert runoff simultaneously.

Wherever feasible, build and stabilize diversions and outlets before initiating other land-disturbing activities.

**Design Criteria**    **Drainage Area:** 5 acres or less.

**Ridge Design:** The ridge should be compacted and designed to have stable side slopes, which should not be steeper than 2:1. When maintenance by machine mowing is planned, side slopes should be no steeper than 3:1. The ridge should be a minimum width of 4 feet at the design water elevation after settlement. Its design should allow for ten percent settlement.

**Channel Design:** Land slope must be taken into consideration when choosing channel dimensions. On the steeper slopes, narrow and deep channels may be required. On the more gentle slopes, broad, shallow channels usually are applicable. The wide, shallow section will be easier to maintain. Since sediment deposition is often a problem in diversions, the designed flow velocity should be kept as high as the channel lining will permit. Unless the purpose of the diversion is to convey clean water around the disturbed area, a diversion should lead to a sediment trapping device. For more detailed information on channel design, see Section 7.27, Stable Channel Design.

**Location:** Diversion location should be determined by considering outlet conditions, topography, land use, soil type, length of slope, seep planes (when seepage is a problem), and the development layout. Diversions should be tailored to fit the conditions for particular location and soil type(s).

**Outlet:** Each diversion must have an adequate outlet. The outlet may be a constructed or natural waterway, a stabilized vegetated area or another energy dissipation device.

In all cases, the outlet must discharge in such a manner as to not cause erosion or sedimentation problems. Protected outlets should be constructed and stabilized prior to construction of the diversion.

**Grade:** Either a uniform or a gradually increasing grade is preferred. Sudden decreases in grade accumulate sediment and should be expected to cause overtopping. A large increase in grade may erode the diversion.

**Stabilization:** Channels should be stabilized in accordance with sound engineering practice to provide adequate stability for expected water velocities. See Section 7.27 for more detailed information on channel linings.

### **WATERBAR DIVERSIONS FOR ROADS**

A detailed design is not required for this type of diversion. Diversions installed to divert water off a road or right-of-way should consist of a series of compacted ridges of soil running diagonally across the road at a 30° angle. Ridges are constructed by excavating a channel up-slope, and using the excavated material for the compacted ridge.

The compacted ridge height should be 8-12" above the original road surface; the channel depth should be 8-12" below the original road surface. Channel bottoms and ridge tops should be smooth enough to be crossed by vehicular traffic. The maximum spacing between diversions is shown in Table 7.22-1. Waterbars should discharge to a stabilized conveyance that carries the storm water to an approved outlet or treatment structure.

#### **Construction Specifications**

- All trees, brush, stumps, obstructions, and other objectionable material should be removed and disposed of so as not to interfere with the proper functioning of the diversion.
- The diversion should be excavated or shaped to line, grade, and cross section as designed to meet the criteria specified herein and be free of irregularities that will impede normal flow.
- All fills should be machine compacted as needed to prevent unequal settlement that would cause damage in the completed diversion.
- All earth removed and not needed in construction should be spread or disposed of so that it will not interfere with the functioning of the diversion.
- Provide sufficient room around the diversion to permit machine regarding and cleanout.
- Diversion channels should be stabilized in accordance with designed plans and specifications.

#### **Maintenance and Inspection Points**

Remove sediment from the flow area and repair the diversion ridge if necessary. Carefully check outlets and make timely repairs as needed. When the area protected is permanently stabilized, remove the ridge and the channel to blend with the natural ground level and appropriately stabilize it.

### Typical Diversion Cross-Sections

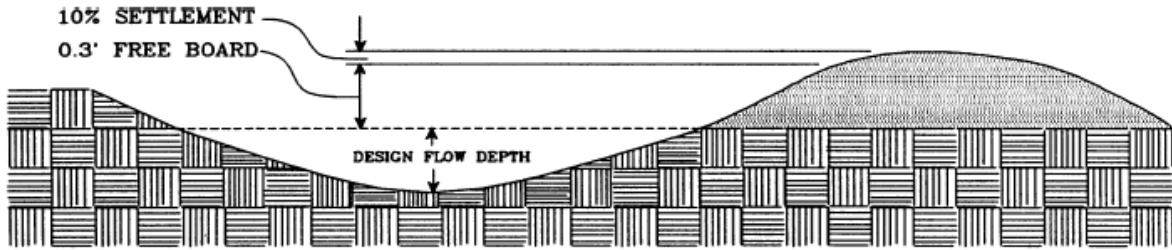

### Typical Parabolic Diversion

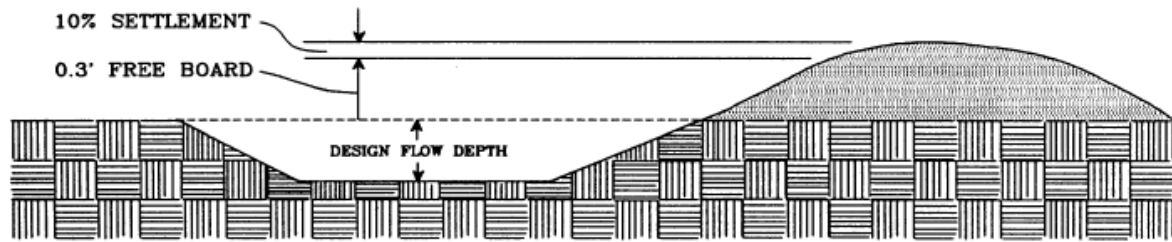

### Typical Trapezoidal Diversion

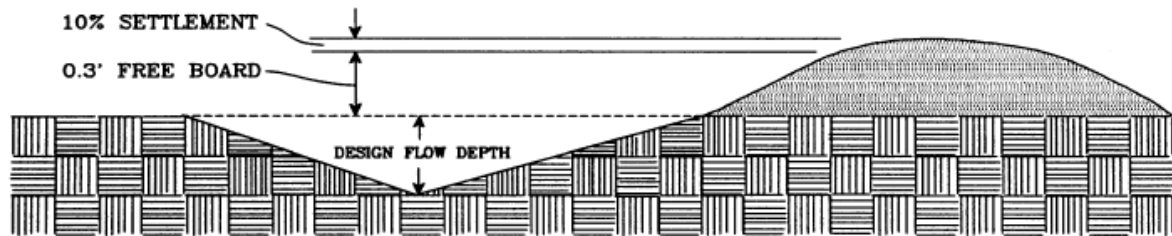

### Typical Vee-Shaped Diversion

Figure 7.22-1 Typical diversion cross sections (Source: VA DSWC)

Road Grade (Percent)	Distance Between Diversions (Feet)
1	400
2	250
5	125
10	80
15	60
20	50

Table 7.22-1 Maximum spacing between waterbar diversions (Source: GA SWCC)

**References** *North Carolina Erosion and Sediment Control Planning and Design Manual*



## RUNOFF CONTROL AND MANAGEMENT

### 7.23 OUTLET PROTECTION



**Definition** A structure designed to control erosion at the outlet of a channel or conduit.

**Purpose** To prevent outlet scouring, reduce water velocity, and dissipate the energy from the flow leaving a pipe to prevent erosion in the downstream channel.

**Conditions Where Practice Applies** This practice applies where the discharge velocity of a pipe, box culvert, diversion, open channel, or other water conveyance structure exceeds the permissible velocity of the receiving water channel or disposal area. Specific applications include:

- Storm drain outlets
- Road culvert outlets
- Paved channel outlets
- Slope drain outlets
- Sediment basin outlets

**Planning Considerations** The outlets of channels, conduits, and other structures are points of high erosion potential because they frequently carry flow at velocities that exceed the allowable limit for the area downstream. To prevent scour and undermining, an outlet stabilization structure is needed to absorb the impact of the flow and reduce the velocity to non-erosive levels. A riprap-lined apron is the most commonly used practice for this purpose because of its relatively low cost and ease of installation. The riprap apron should be extended downstream until stable conditions are reached even though this may exceed the length calculated for design velocity control. Riprap stilling basins or plunge pools reduce flow velocity rapidly. They should be considered in lieu of aprons where pipe outlets are cantilevered or where high flows would require an excessive apron length. Consider other energy dissipaters such as concrete impact basins or paved outlet structures where conditions warrant.

The installation of a culvert in a stream is subject to the conditions of a U.S. Army Corps of Engineers 404 permit and Tennessee ARAP conditions. These permit

conditions may not allow the use of a riprap apron, and may require that the bottom of the culvert be buried below the natural stream bed elevation. A pre-formed scour pool or plunge pool should be considered in these situations.

**Design Criteria Capacity:** The structure should be designed to handle the peak storm flow ( $Q$ ) in cubic feet per second (cfs) from the 25-year, 24-hour frequency storm, or the design discharge of the water conveyance structure, whichever is greater.

**Velocity:** Compute velocity using Manning's equation with an appropriate  $n$  value for the selected outlet protection material.

**Tailwater Depth:** The design depth of the tailwater immediately below the pipe outlet must be determined for the design capacity of the pipe. Manning's Equation may be used to determine the tailwater depth. If the tailwater depth is less than half the diameter of the pipe, it should be classified as a low tailwater condition. If the tailwater depth is greater than half the pipe diameter, then it should be classified as a high tailwater condition. Pipes which outlet onto flat areas with no defined channel may be assumed to have a low tailwater condition.

**Apron Length ( $L_A$ ):** The apron length should be determined according to tailwater conditions described in Table 7.23-1.

**Apron Width ( $W_A$ ):** See Figure 7.23-1. If the pipe discharges directly into a well-defined channel, the apron should extend across the channel bottom and up the channel banks to an elevation 1 foot above the high tailwater depth or to the top of the bank (whichever is less). If the pipe discharges onto a flat area with no defined channel, the width of the apron should be determined as follows:

- The upstream end of the apron, adjacent to the pipe, should have a width three times the diameter of the outlet pipe
- For a low tailwater condition, the downstream end of the apron should have a width equal to the pipe diameter plus the length of the apron.
- For a high tailwater condition, the downstream end should have a width equal to the pipe diameter plus 0.4 times the length of the apron.

**Grade:** The apron should be constructed on zero grade. The invert elevation of the downstream end of the apron should be equal to the elevation of the invert of the receiving channel. There should be no turbulence at the end of aprons.

**Side Slope:** If the pipe discharges into a well defined channel, the side slopes of the channel should not be steeper than 2:1.

**Alignment:** The apron should be straight throughout its entire length, but if a curve is necessary to align the apron with the receiving stream, locate the curve in the upstream section of the riprap.

**Materials:** The apron may be lined with riprap, grouted riprap, or concrete. The median sized stone for riprap ( $d_{50}$ ) should be determined according to tailwater conditions described in Table 7.23-1. Maximum stone size is equal to 1.5 times the  $d_{50}$  value. The gradation, quality, and placement of riprap should conform to riprap specifications.

**Thickness:** Make the minimum thickness of riprap 1.5 times the maximum stone diameter.

**Stone Quality:** Select stone for riprap from field stone or quarry stone. The stone should be hard, angular, and highly weather resistant. The specific gravity for the individual stones should be at least 2.5.

**Separators:** A separator must be provided between the riprap and natural ground. Suitable filters are flexible and consist of a well-graded gravel or sand-gravel layer or a synthetic filter fabric manufactured for this express purpose. The design of a gravel filter blanket is based on the ratio of particle size in the overlying filter material to that of the base material in accordance with the criteria below. The designed gravel filter blanket may consist of several layers of increasingly large particles from sand to erosion control stone.

**A gravel filter blanket** should have the following relationship for a stable design:

$$\frac{d_{15} \text{ filter}}{d_{85} \text{ base}} \leq 5$$

$$5 \leq \frac{d_{15} \text{ filter}}{d_{15} \text{ base}} \leq 40$$

$$\frac{d_{50} \text{ filter}}{d_{50} \text{ base}} \leq 40$$

In these relationships, filter refers to the overlying material, and base refers to the underlying material. These relationships must hold between the filter material and the base material (soil foundation), and between the riprap and the filter. More than one layer of filter material may be needed. Each layer of filter material should be at least 6 inches thick.

**A synthetic filter fabric** may be used with or in place of gravel filters. The following particle size relationships should exist:

- Filter fabric covering a base with granular particles containing 50% or less (by weight) of fine particles (less than U.S. Standard Sieve no. 200 [0.074mm]):
  - a.  $\frac{d_{85} \text{ base (mm)}}{\text{EOS}^* \text{ filter fabric (mm)}} > 1$
  - b. total open area of filter should not exceed 36%.
- Filter fabric covering other soils:
  - a. EOS is no larger than U.S. Standard Sieve no. 70 (0.21mm),
  - b. total open area of filter should not exceed 10%.

\*EOS - Equivalent opening size compared to a U.S. standard sieve size.

No filter fabric should have less than 4% open area, or an EOS less than U.S. Standard Sieve No. 100 (0.15mm). The permeability of the fabric must be greater than that of the soil. The fabric may be made of woven or nonwoven monofilament yarns, and should meet the following minimum requirements:

- thickness 20 - 60 mils,
- grab strength 90 - 120 lb, and
- conform to ASTM D-1682 or ASTM D-177.

Filter blankets should always be provided where seepage is significant, or where flow velocity and duration of flow or turbulence may cause the underlying soil particles to move through the riprap.

**Energy Dissipators and Stilling Basins:** Structural controls, generally made from precast concrete or from pour-in-place concrete, should be used whenever concrete aprons are installed. The design of the energy dissipators and stilling basins shown in Figure 7.23-2 are discussed in the Federal Highways Administration (FHWA) publication HEC-14, Hydraulic Design of Energy Dissipators for Culverts and Channels.

Stilling basins are used to convert flows from supercritical to subcritical flow rates by allowing a hydraulic jump to occur. The stilling basin allows a controlled hydraulic jump to occur within the structure over a wide range of flow conditions and depths. A professional engineer must design energy dissipators and stilling basins using hydraulic computations. A primary concern for both energy dissipators and stilling basins is whether sediment and trash can accumulate. TDOT standard drawings include a riprap basin energy dissipater, based upon procedures in HEC-14. The United States Bureau of Reclamation (USBR) also has developed many designs of such structures.

### **Construction Specifications**

- Ensure that the subgrade for the geotextile and riprap follows the required lines and grades shown in the plan. Compact any fill required in the subgrade to the density of the surrounding undisturbed material. Low areas in the subgrade on undisturbed soil may also be filled by increasing the riprap thickness.
- Install a geotextile liner to prevent soil movement through the openings in the riprap
- The geotextile must meet design requirements and be properly protected from punching or tearing during installation. Repair any damage by removing the riprap and placing another piece of geotextile over the damaged area. All connecting joints should overlap a minimum of 1 foot. If the damage is extensive replace the entire geotextile liner.
- Riprap may be placed by equipment, but take care to avoid damaging the geotextile.
- The minimum thickness of the riprap should be 1.5 times the maximum stone diameter, but not less than 6 inches.
- The outlet structure must conform to the specified grading limits shown on the plans.

- Construct the apron on zero grade with no turbulence at the end. Make the top of the riprap at the downstream end level with the receiving area or slightly below it.
- Ensure that the apron is properly aligned with the receiving stream and, preferably, straight throughout its length.
- Immediately after construction, stabilize all disturbed areas with vegetation.
- Select stone for riprap from fieldstone or quarry stone. The stone should be hard, angular, and highly weather-resistant. The specific gravity of the individual stones should be at least 2.5.

**Maintenance and Inspection Points** Inspect riprap outlet structures after heavy rains to see if any erosion around or below the riprap has taken place, if the stones have been dislodged, or if the separator has been damaged. Immediately make all needed repairs to prevent further damage.

**References** *TDOT Design Division Drainage Manual*  
*TDOT Standard Drawing EC-STR-21*  
*North Carolina Erosion and Sediment Control Planning and Design Manual*  
*Federal Highways Administration, HEC-14*



<b>Riprap Aprons for Low Tailwater (downstream flow depth &lt; 0.5 x pipe diameter)</b>															
Culvert Diameter	Lowest value			Intermediate values to interpolate from									Highest value		
	Q	L <sub>A</sub>	D <sub>50</sub>	Q	L <sub>A</sub>	D <sub>50</sub>	Q	L <sub>A</sub>	D <sub>50</sub>	Q	L <sub>A</sub>	D <sub>50</sub>	Q	L <sub>A</sub>	D <sub>50</sub>
	Cfs	Ft	In	Cfs	Ft	In	Cfs	Ft	In	Cfs	Ft	In	Cfs	Ft	In
12"	4	7	2.5	6	10	3.5	9	131	6	12	16	7	14	17	8.5
15"	6.5	8	3	10	12	5	15	16	7	20	18	10	25	20	12
18"	10	9	3.5	15	14	5.5	20	17	7	30	22	11	40	25	14
21"	15	11	4	25	18	7	35	22	10	45	26	13	60	29	18
24"	21	13	5	35	20	8.5	50	26	12	65	30	16	80	33	19
27"	27	14	5.5	50	24	9.5	70	29	14	90	34	18	110	37	22
30"	36	16	6	60	25	9.5	90	33	15.5	120	38	20	140	41	24
36"	56	20	7	100	32	13	140	40	18	180	45	23	220	50	28
42"	82	22	8.5	120	32	12	160	39	17	200	45	20	260	52	26
48"	120	26	10	170	37	14	220	46	19	270	54	23	320	64	37
<b>Riprap Aprons for High Tailwater (downstream flow depth &gt; 0.5 x pipe diameter)</b>															
Culvert Diameter	Lowest value			Intermediate values to interpolate from									Highest value		
	Q	L <sub>A</sub>	D <sub>50</sub>	Q	L <sub>A</sub>	D <sub>50</sub>	Q	L <sub>A</sub>	D <sub>50</sub>	Q	L <sub>A</sub>	D <sub>50</sub>	Q	L <sub>A</sub>	D <sub>50</sub>
	Cfs	Ft	In	Cfs	Ft	In	Cfs	Ft	In	Cfs	Ft	In	Cfs	Ft	In
12"	4	8	2	6	18	2.5	9	28	4.5	12	36	7	14	40	8
15"	7	8	2	10	20	2.5	15	34	5	20	42	7.5	25	50	10
18"	10	8	2	15	22	3	20	34	5	30	50	9	40	60	11
21"	15	8	2	25	32	4.5	35	48	7	45	58	11	60	72	14
24"	20	8	2	35	36	5	50	55	8.5	65	68	12	80	80	15
27"	27	10	2	50	41	6	70	58	10	90	70	14	110	82	17
30"	36	11	2	60	42	6	90	64	11	120	80	15	140	90	18
36"	56	13	2.5	100	60	7	140	85	13	180	104	18	220	120	23
42"	82	15	2.5	120	50	6	160	75	10	200	96	14	260	120	19
48"	120	20	2.5	170	58	7	220	85	12	270	105	16	320	120	20

**Table 7.23-1 Riprap outlet protection design parameters for low tailwater and high tailwater conditions (Source: Knoxville Engineering Department)**

Note that the above table is intended to select two parameters for the design of riprap outlet protection, based upon outlet velocities that correspond with circular culverts flowing full. Flow values less than the lowest value for the culvert size usually indicate a full-flow velocity less than 5 feet per second, for which riprap is usually not necessary. Flow values more than the highest value for the culvert size usually indicates that a concrete stilling basin or energy dissipater structure is necessary.

Adjust values upward if the circular culvert is not flowing full based upon outlet conditions. For noncircular pipes, convert into an equivalent cross-sectional area of circular culvert to continue design.

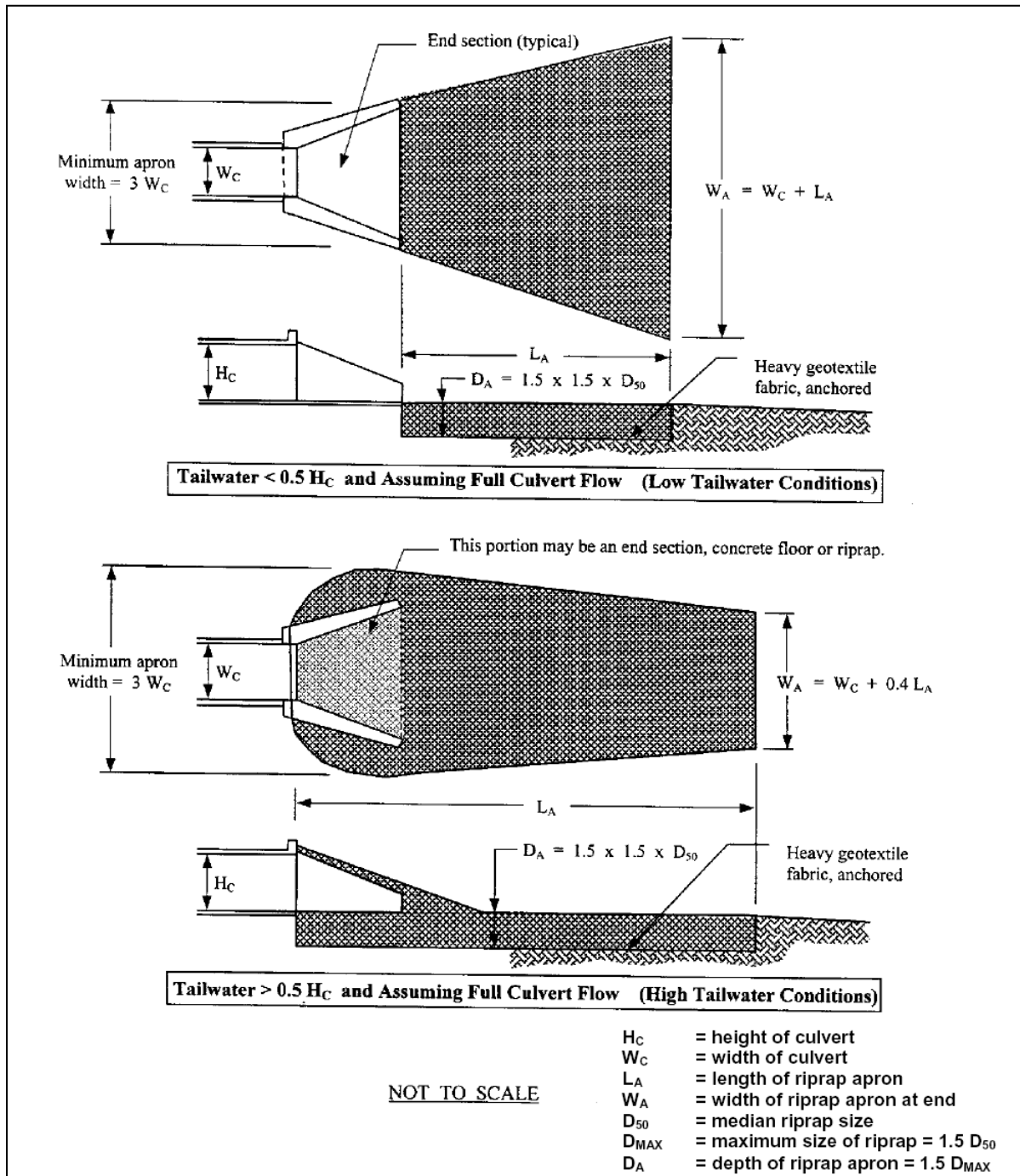

Figure 7.23-1 Riprap outlet protection dimensions  
(Knoxville Engineering Department)

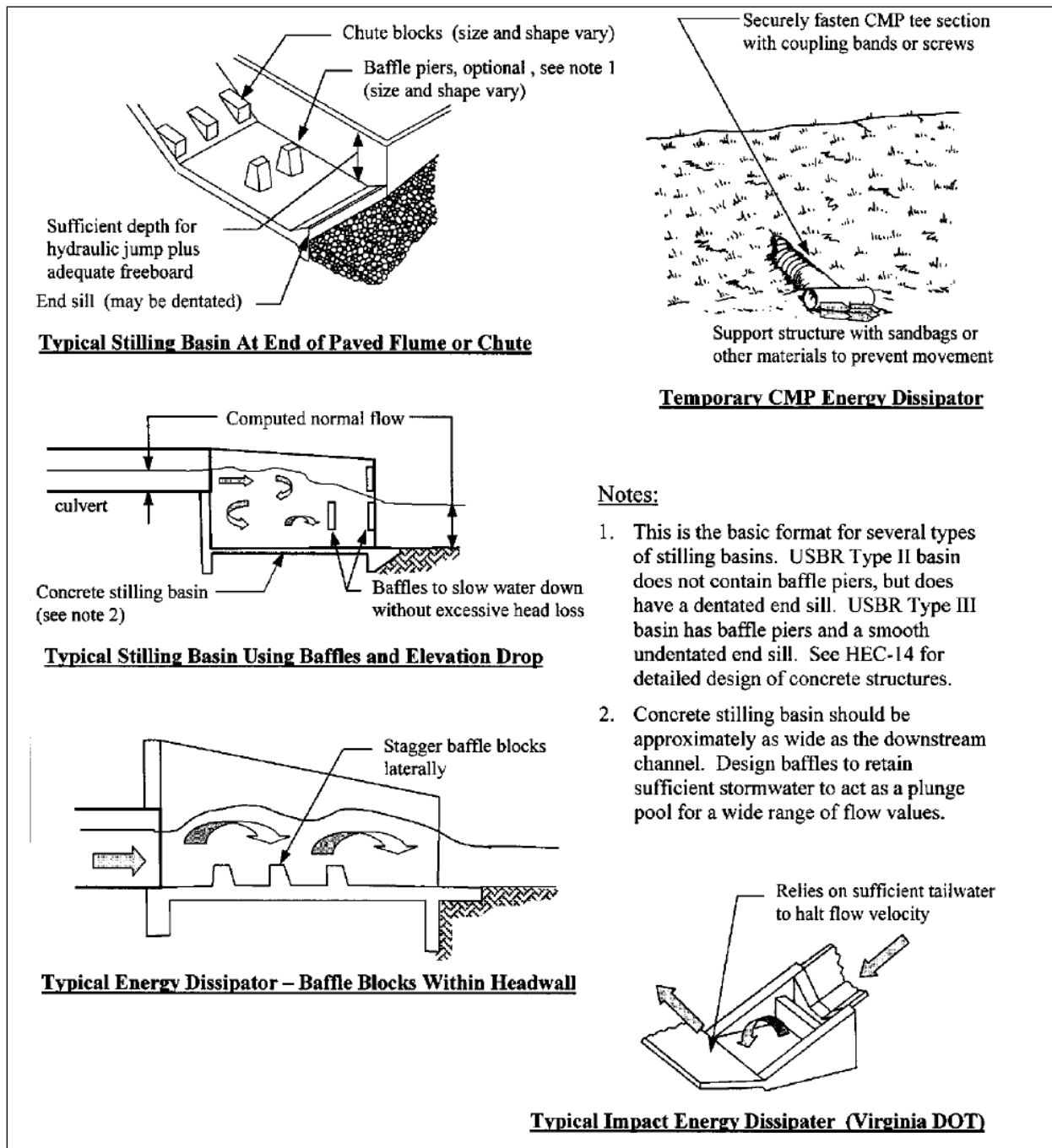

Figure 7.23-2 Stilling basins and other energy dissipaters  
(Source: Knoxville Engineering Department)

## RUNOFF CONTROL AND MANAGEMENT

### 7.24 SLOPE DRAIN



SLOPE DRAIN

- Definition** A flexible tubing or conduit extending temporarily from the top to the bottom of a cut or fill slope.
- Purpose** To convey storm water runoff down the face of a cut or fill slope without causing erosion on or below the slope.
- Conditions Where Practice Applies** Temporary slope drains are used where sheet or concentrated storm water flow could cause erosion as it moves down the face of a slope. These structures are removed once the permanent storm water disposal system is installed.
- Planning Considerations** There is often a significant lag between the time a cut or fill slope is graded and the time it is permanently stabilized. During this period, the slope is vulnerable to erosion, and temporary slope drains together with temporary diversions can provide valuable protection.

It is very important that these temporary structures be sized, installed, and maintained properly because their failure will usually result in severe erosion of the slope. The entrance section to the drain should be well entrenched and stable so that surface water can enter freely. The drain should extend down slope beyond the toe of the slope to a stable area or appropriately stabilized outlet.

Other points of concern are failure from overtopping from inadequate pipe inlet capacity and lack of maintenance of diversion channel capacity and ridge height.

**Design Criteria Placement:** The temporary slope drain should be located on undisturbed soil or well compacted fill.

**Diameter:** The diameter of the temporary slope drain should provide sufficient capacity to convey the maximum runoff expected during the life of the drain. Refer to the table below for selecting the pipe diameter of a slope drain.

Maximum Drainage Area per Pipe (acres)	Pipe Diameter (inches)
0.50	12
0.75	15
1.00	18
>1.00*	as designed

\*Inlet design becomes more complex beyond this size.

**Table 7.24-1 Slope drain sizing**  
(Source: North Carolina Erosion and Sediment Control Planning and Design Manual)

**Slope Drain Inlet and Outlet:** See

**Figure 7.24-1** for typical slope drain details. Diversion structures are used to direct runoff to the slope drain's "Tee" or "Ell" inlet at the top of the slope. Use an earthen diversion with a dike ridge to direct surface runoff into the temporary slope drain. Make the height of the ridge over the drain conduit a minimum of 1.5 feet and at least 6 inches higher than the adjoining ridge on either side. The lowest point of the diversion ridge should be a minimum of 1 foot above the top of the drain so that design flow can freely enter the pipe.

The entrance section should slope toward the entrance to the slope drain at a minimum of 1/2-inch per foot. Make all fittings watertight. A standard T-section fitting may also be used at the inlet. **Thoroughly compact selected soil around the inlet section to prevent the pipe from being washed out by seepage or piping.** A stone filter ring or other inlet protection may be placed at the inlet for added sediment filtering capacity. These sediment-filtering devices should be removed if flooding or bank over wash occurs.

Rock riprap should be placed at the outlet for energy dissipation. A Tee outlet, flared end section, or other suitable device may be used in conjunction with the riprap for additional protection.

**Pipe Material:** Construct the slope drain from heavy-duty, flexible materials such as nonperforated, corrugated plastic pipe or specially designed flexible tubing. Install reinforced, hold-down grommets or stakes to anchor the pipe at intervals not to exceed 10 ft with the outlet end securely fastened in place. The pipe must extend beyond the toe of the slope.



**Construction Specifications**

A common failure of slope drains is caused by water saturating the soil at the inlet section and seeping along the pipe. This creates voids and piping to occur, causing washouts. Proper back filling around and under the pipe with stable soil material, and hand compacting in 6-inch lifts to achieve firm contact between the pipe and the soil at all points, will eliminate this type of failure.

- Stabilize the slope with seed and mulch or matting.
- Place slope drains on the stabilized sloped.
- The entrance section should slope toward the inlet to the slope drain at a minimum of 1/2-inch per foot.
- Hand compact the soil under and around the inlet and exit sections in lifts not to exceed 6 inches.
- Ensure that the fill used to anchor the slope drain inlet at the top of the slope has minimum dimensions of 1.5 ft. depth, 2 ft. top width, and 3:1 side slopes.
- Ensure that all slope drain connections are watertight. Poor connections of sections of pipe can cause pipe failure and erosion on the slope.
- Ensure that all fill material is well compacted. Securely fasten the exposed section of the drain with grommets or stakes at all joints and spaced not to exceed 10 feet apart.
- Place the drain slightly diagonally across the slope, extending the drain beyond the toe of the slope. The outlet end should be directed toward the downstream direction. Protect the outlet area from erosion by installing rip rap outlet protection.
- If the drain is conveying sediment-laden runoff, direct all flows into a sediment trap or sediment basin.
- Make the settled, compacted diversion no less than one foot above the top of the pipe at every point.
- Immediately stabilize all disturbed areas following construction.

**Maintenance and Inspection Points**

Inspect the slope drain and supporting diversion after rainfall, and promptly make necessary repairs. When the protected area has been permanently stabilized and the permanent storm water disposal system is fully functional, temporary measures may be removed, materials disposed of properly, and all disturbed areas stabilized appropriately.

**References**

*TDOT Design Division Drainage Manual*

*TDOT Erosion Control Standard Drawing EC-STR-27*

*North Carolina Erosion and Sediment Control Planning and Design Manual*

*Georgia Soil and Water Conservation Commission*

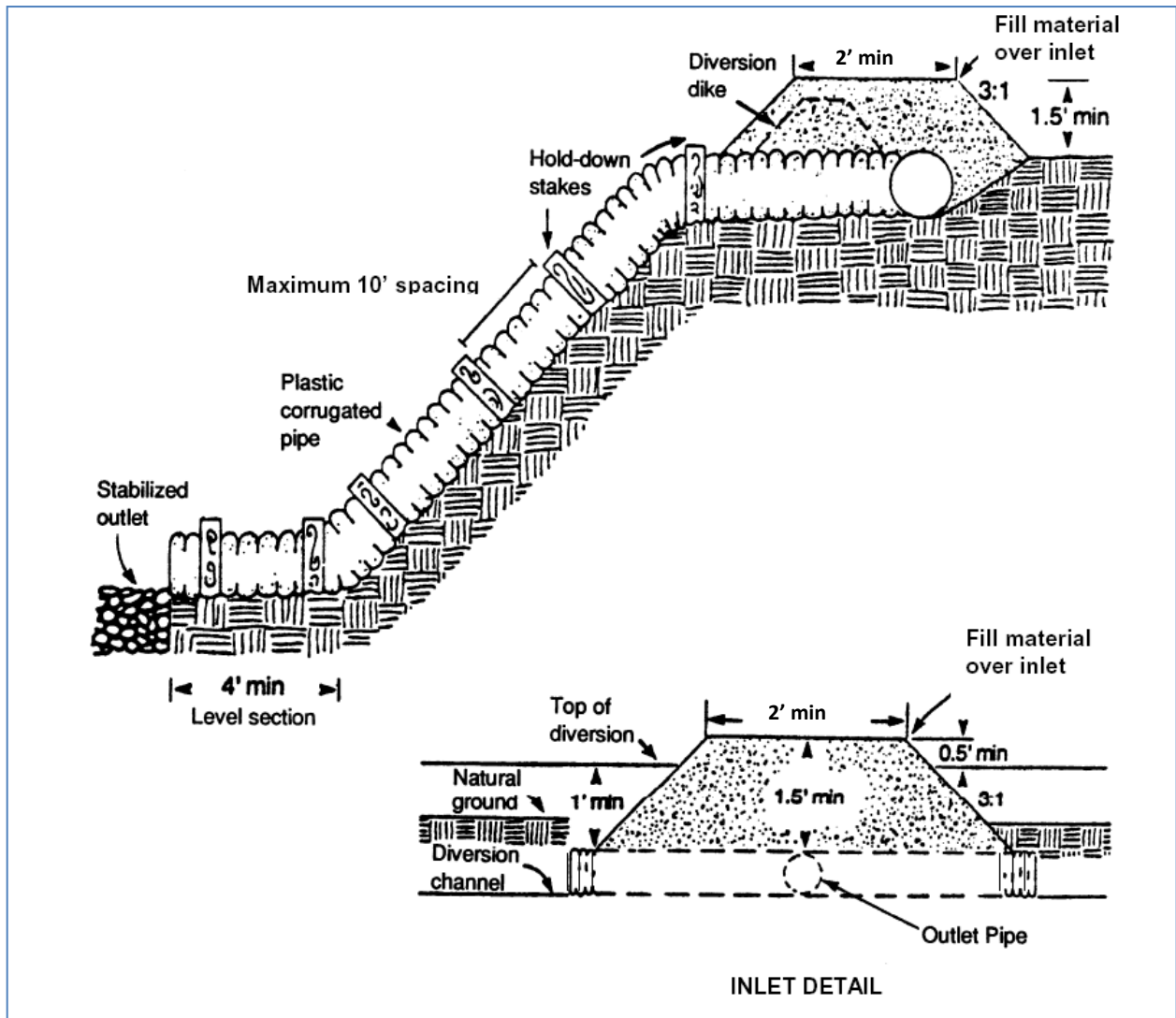

Figure 7.24-1 Slope drain pipe and inlet detail  
(Source: GA SWCC)

## RUNOFF CONTROL AND MANAGEMENT

### 7.25 TUBES AND WATTLES



<b>Definition</b>	A small temporary barrier, grade control structure or dam constructed across a swale, drainage ditch, or area of concentrated flow.
<b>Purpose</b>	To minimize the erosion rate by reducing the velocity of storm water in areas of concentrated flow, and to capture larger soil particles.
<b>Conditions Where Practice Applies</b>	This practice is applicable in a ditch to help reduce the effects of soil erosion and aid in sediment retention. Sediment tubes and wattles should not be used in streams.
<b>Planning Considerations</b>	The stability of tubes and wattles is very dependent upon proper staking. Thus, they may not be utilized on pavement, rocky soil or at any location where the stakes cannot be driven to the required depth.
<b>Design Criteria</b>	<p>The maximum drainage area to any given tube or wattle should be no more than 5 acres. When applied in a ditch, the same design requirements as rock check dams apply. The depth of flow on the center of the wattle or tube (weir) shall be computed for the peak flow rate generated by the 2-year, 24-hour storm in order to ensure that the top of the structure and ditch will not be overtopped. For sites draining to high quality streams or streams listed as impaired by sediment, the depth must be determined for the 5-year, 24-hour peak flow rate. The weir section must be at least 9 inches deep. See Table 7.25-1 for the minimum spacing for ditch applications.</p> <p>Joints within a ditch section should be avoided. However, where joints are necessary, a second row of tubes or wattles is required with the joints staggered by a distance equal to half of the individual segment length.</p> <p>Tube/wattle netting should be a knitted material with 1/8 to 3/8 inch openings and made of photodegradable (polypropylene, HDPE) or biodegradable (cotton, jute, coir) material. The minimum diameter for any tube or wattle applied in a ditch should be 12 inches. This will ensure that the tube will function effectively as a velocity control device.</p>

Slope (%)	Maximum Tube/ Wattle Spacing (ft.)
< 2	125
2	100
3	75
4	50
5	40
6	30
> 6	25

**Table 7.25-1 Maximum Spacing for Wattles/Tubes in Ditch Application (Source: TDOT)**

### Construction Specifications

Proper site preparation is essential to ensure tubes and wattles are in complete contact with the underlying soil surface. Remove all rocks, clods, vegetation or other obstructions so installed tubes and wattles have direct contact with the underlying soil surface.

Install tubes and wattles by laying them flat on the ground. Install stakes at spacings per the manufacturer's recommendation. Stakes should be installed on the downstream side of the wattles/tubes.

Install tubes so no gaps exist between the soil and the bottom of the tube.

Keep tubes in place until the contributing drainage area has been stabilized.

The ends of the wattle or tube must extend up the ditch side slopes at least 6" vertical above the weir flow depth (see Figure 7.25-1 below).

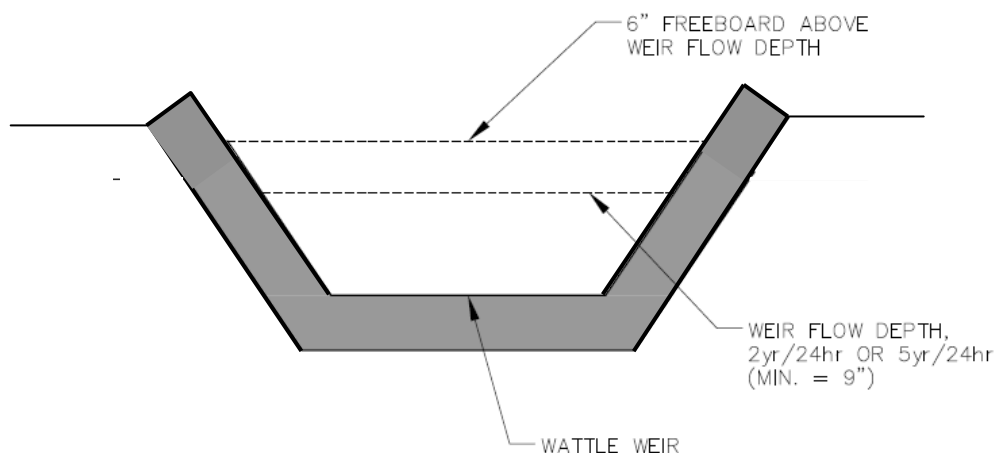

**Figure 7.25-1 Cross sectional view of wattle installed in ditch**

**Maintenance  
and Inspection  
Points**

- Inspect wattles and tubes after installation for gaps under the tubes and for gaps between the joints of adjacent ends of tubes. Ensure stakes are on the downstream side.
- Repair all rills, gullies, and undercutting near tubes.
- Remove all sediment deposits when the sediment reaches 1/3 the height of the exposed tube.
- Remove and/or replace installed sediment tubes as required to adapt to changing construction site conditions.
- Most tubes and wattles are filled with biodegradable materials. When the fill materials degrade and settle, the wattle should be replaced.
- At the end of the project, biodegradable wattles and tubes can be split open, the netting material and stakes removed, and the biodegradable material left in place to aid stabilization.

**References** *TDOT Design Division Drainage Manual*

*TDOT Erosion Control Standard Drawing EC-STR-31*

*South Carolina Department of Health & Environmental Control Stormwater Management BMP Handbook*



## RUNOFF CONTROL AND MANAGEMENT

### 7.26 LEVEL SPREADER



LEVEL SPREADER

- Definition** A level spreader is a flow control measure that receives concentrated, potentially erosive inflows and converts them to a sheet flow condition by means of a horizontal weir and channel.
- Purpose** To convert concentrated flow to sheet flow and release it uniformly over a stabilized area.
- Conditions Where Practice Applies**
- Where sediment-free storm runoff can be released in sheet flow down a stabilized slope without causing erosion.
  - Where a level lip can be constructed without filling.
  - Where the area below the spreader lip is uniform with the slope of 10% or less and is stable for anticipated flow conditions, preferably well-vegetated.
  - Where the runoff water will not re-concentrate after release.
  - Where there will be no traffic over the spreader.
- Planning Considerations** The level spreader is a relatively low-cost structure to release small volumes of concentrated flow where site conditions are suitable. The outlet area must be uniform and well-vegetated with slopes of 10% or less. Particular care must be taken to construct the outlet lip **completely level** in a stable, undisturbed soil. Any depressions in the lip will concentrate the flow, resulting in erosion. Evaluate the outlet system to be sure that flow does not concentrate below the outlet. The level spreader is most often used as an outlet for temporary or permanent diversions and diversion dikes. Runoff water containing high sediment loads must be treated in a sediment trapping device before release in a level spreader.

**Design Criteria** Level spreaders contain 3 components:

1. **Forebay:** The forebay is used for the preliminary treatment of stormwater. It is an excavated, bowl-shaped feature that slows the influent stormwater and allows heavy sediment and debris to settle. The forebay may be lined with riprap to reduce erosion within the excavated area. The uneven riprap surfaces function as small sediment traps. Forebays dissipate energy and reduce the sediment that accumulates behind the level spreader lip.
2. **Channel:** After the stormwater passes through the forebay, it enters a concrete, rock, or grassed channel – the main body of the level spreader. This is a dead-end channel because it does not directly connect the watershed to the stream. Instead, the channel is a long, shallow impoundment that fills to the level of its lower side. The lower side (the *downslope side*) of the channel is constructed so that it is level along its full length. This lower side, or **level spreader lip**, is often constructed of concrete or rock so that it resists erosion. As stormwater enters the channel, it rises until it fills the channel and exits evenly over the lip. The downslope side of the system functions as a long, broad-crested weir.
3. **Vegetated buffer.** After the runoff passes over the level spreader lip, it enters the vegetated buffer. As runoff passes through the buffer vegetation, some of the water infiltrates. Ideally, the buffer will remove sediment and nutrients from runoff before it reaches the stream.

**Design parameters:**

**Capacity** – Determine the capacity of the spreader by estimating peak flow from the 10-year storm. Restrict the drainage area so that maximum flows into the spreader will not exceed 30 cfs.

**Channel dimensions** – When water enters the spreader from one end, as from a diversion, select the appropriate length, width, and depth of the spreader from Table 7.26-1.

Construct a 20-foot transition section in the diversion channel so the width of the channel will smoothly meet the width of the spreader to ensure uniform outflow.

Design Flow cfs	Entrance Width ft	Depth ft	End Width ft	Length ft
0-10	10	0.5	3	10
10-20	16	0.6	3	20
20-30	24	0.7	3	30

**Table 7.26-1 Spreader Dimensions**

The grade of the last 20 feet of the diversion channel should provide a smooth transition from the diversion channel to the level spreader. The grade of the spreader should be 0%.

**Spreader lip** – A level spreader system must have a stable lip that cannot be eroded. Concrete level spreaders can be built with minimal slope along the length of the channel's downslope side. Concrete level spreaders resist erosion better than level

spreaders made of earth, gravel, or both (see Figure 7.26-1). If a flow greater than the design flow is routed over a level spreader made of concrete, the level spreader lip will not be damaged. Level spreaders made of earth, gravel, or both should not be used in any urban applications because they routinely fail. Another stable material is a metal gutter. Like concrete level spreaders, pre-fabricated metal level spreaders can be expected to remain level with minimal maintenance.

The lip of the concrete level spreader must be higher than the existing ground by 3 to 6 inches. This allows water to pass over the lip without interference from buffer vegetation. To limit any erosion that could occur as water falls from the top of the level spreader to the existing soil, extend a layer of filter fabric a distance of 3 feet from the level spreader lip towards the riparian vegetation. Stone, such as No. 57 stone, should be placed on top of the filter fabric (3 to 4 inches deep) to reduce erosion just downslope of the level spreader (Figure 7.26-1). A 3-foot wide strip of erosion control matting can be used in place of the filter fabric and No. 57 stone combination. However, such an area must be stable and have adequate vegetation before receiving stormwater.

Construct the level lip on undisturbed soil to uniform height and zero grade over the length of the spreader. Protect it with an erosion-resistant material, such as fiberglass matting, to prevent erosion and allow vegetation to become established. Other materials can be considered for the construction of a level lip, such as concrete, pressure treated wood and other rigid materials. Regardless of the materials used, the lip of the spreader must be level.

**Outlet area** – The outlet disposal area must be generally smooth and well-vegetated with a maximum slope of 10%.

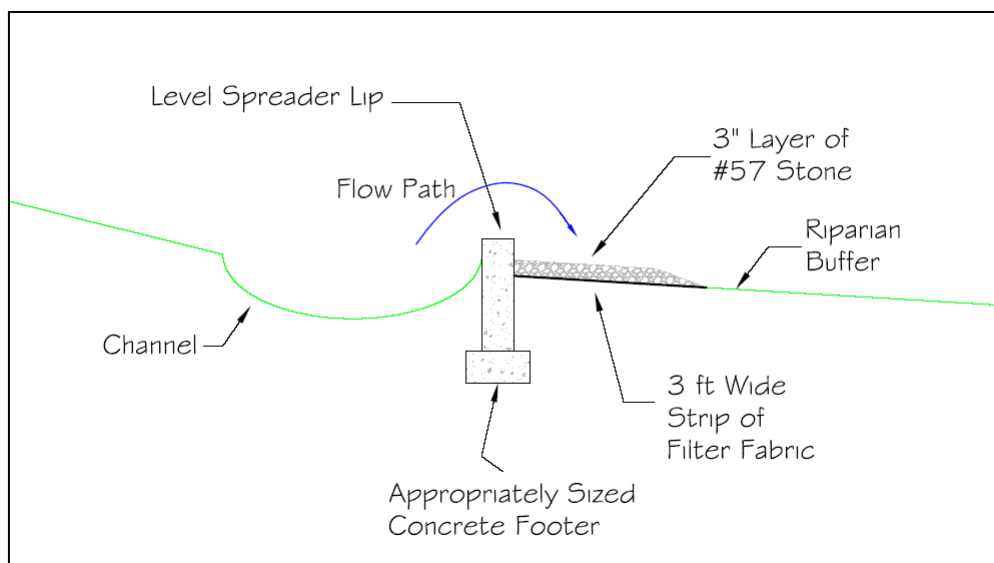

**Figure 7.26-1 Cross Section of Concrete Level Spreader**  
(Source: NCSU Cooperative Extension Service)

**Construction Specifications**

- Construct the level spreader on undisturbed soil (not on fill).
- Ensure that the spreader lip is level for uniform spreading of runoff.
- Construct a 20-foot transition section from the diversion channel to blend smoothly to the width and depth of the spreader.
- Disperse runoff from the spreader across a properly stabilized slope not to exceed 10%. Make sure the slope is sufficiently smooth to keep flow from concentrating.
- Immediately after its construction, appropriately seed and mulch the entire disturbed area of the spreader.

**Maintenance and Inspection Points**

Immediately remove any sediment which has collected in the level spreader channel or in the forebay.

**References**

*TDOT Design Division Drainage Manual*

*TDOT Erosion Control Standard Drawing EC-STR-61*

*North Carolina Erosion and Sediment Control Planning and Design Manual*

*North Carolina State University Cooperative Extension Service.*

## RUNOFF CONTROL AND MANAGEMENT

### 7.27 CHANNELS (STABLE CHANNEL DESIGN)

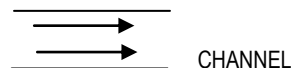

**Definition** A runoff conveyance measure constructed to the design cross section and grade, and stabilized with erosion-resistant linings such as vegetation, riprap, paving, or other structural material. For the purposes of this section, channels do not include streams.

**Purpose** To convey and dispose of concentrated surface runoff without damage from erosion, deposition, or flooding.

**Conditions Where Practice Applies** This practice applies to construction sites that contain concentrated runoff in a ditch or open channel. Typical locations of channels or ditches include roadside ditches, channels at property boundaries, channels created by diversion structures, or channels designed as part of a site's permanent storm water conveyance system.

**Planning Considerations** **Location.** Generally, channels should be located to conform with and use the natural drainage system. Channels may also be needed along development boundaries, roadways, and rear lot lines. Avoid channels crossing watershed boundaries or ridges. Plan the course of the channel to avoid sharp changes in direction or grade. Site development should conform to natural features of the land and use natural drainageways rather than drastically reshape the land surface. Major reconfiguration of the drainage system often entails increased maintenance and risk of failure.

**Stabilized channels must be isolated from sedimentation from disturbed areas.**

Stable grass-lined channels resemble natural drainage systems and, therefore, are usually preferred if design shear stress is below 2 lb/ft<sup>2</sup> and velocities below 5 ft/sec.



Construct and stabilize channels early in the construction schedule before grading and paving increase the rate of runoff. Where grass-lined channels are designed, geotextile fabrics or straw and netting provide stability until the vegetation is fully established. These protective liners must be used whenever design velocities exceed 2 ft/sec for bare soil conditions. It may also be necessary to divert water from the channel until vegetation is established, or to line the channel with sod.

Sediment traps may be needed at channel inlets and outlets.

**V-shaped channels** generally apply where the quantity of water is small, such as in short reaches along roadsides. The V-shaped cross section is least desirable because it is difficult to stabilize the bottom where velocities may be high.

**Parabolic channels** are often used where larger flows are expected and space is available. The swale-like shape is pleasing and may best fit site conditions.

**Trapezoidal channels** are used where runoff volumes are large and slope is low.

Subsurface drainage, or riprap channel bottoms, may be necessary on sites that are subject to prolonged wet conditions due to long duration flows or high water tables.

Construction drawings should include specifications to provide sufficient channel undercutting to allow for thickness of some linings such as rock to preserve the required flow depth.

**Outlets.** Channel outlets must be stable. Where channel improvement ends, the exit velocity for the design flow must be nonerosive for the existing receiving system conditions. Stability conditions beyond the property boundary should always be considered.

Where velocities exceed 2 ft/sec, more durable channel linings are required. Liners for channels may be classified as either flexible or rigid. The primary difference between rigid and flexible channel linings from an erosion control standpoint is the lining's response to changing channel shape. Flexible linings are able to conform to changes in the channel shape while rigid linings will not. Flexible linings can accommodate some change in channel shape while maintaining their overall integrity. Rigid linings tend to fail if a portion of the lining is damaged by undermining or slumping. Thus, where flexible linings are capable of withstanding the design shear stress, they are preferred over rigid linings. Flexible linings usually will consist of sod or seeded grasses, erosion control blankets or turf reinforcement mats, machined rock (riprap), cobbles, or wire-enclosed rock (such as gabions or mattresses).

Rigid linings may consist of either cast-in-place concrete, grouted riprap, or stone masonry. As a general rule, the use of rigid linings should be avoided unless they are intended to be permanent. Channel design in this manual only addresses flexible channel linings.

**Design Criteria** Design of channels should be consistent with the U.S. Department of Transportation – Federal Highway Administration: Hydraulic Engineering Circular Number 15 (HEC15). This design method is based on the concept of maximum permissible tractive force, or shear stress. The method has two parts, computation of the flow conditions for a given design discharge and determination of the degree of erosion protection required. The flow conditions are a function of the channel geometry, design discharge, channel roughness, channel alignment and channel slope. The erosion protection required can be determined by computing the shear stress on the channel lining (and underlying soil, if applicable) at the design discharge and comparing that stress to the permissible value for the type of lining/soil that makes up the channel boundary.

For simplification, the following channel design conditions are addressed in this manual:

- Straight channels
- Channel bends
- Flexible linings
- Uniform flow

**General design guidance:**

- Avoid supercritical flow or include a drop structure and hard armoring in the design. Where design indicates supercritical flow, consider changing the channel geometry.
- Design must consider the construction phase and permanent stormwater management conveyance (after construction is complete) phase. Factors used in the design should reflect these conditions.
- Where slopes over 10% and/or supercritical flow cannot be avoided, use FHWA's HEC 15 for a more detailed design using hard armoring and/or grade control structures.
- On steep slopes, shorten the effective slope length by installing drop structures or "turn outs" that discharge runoff non-erosively over stable slopes.
- At a minimum, the freeboard should be sufficient to prevent waves or fluctuations in water surface from washing over the sides. In a permanent roadway channel, about 0.5 ft of freeboard should be adequate, and for transitional channels, zero freeboard may be acceptable. Steep gradient channels should have a freeboard height equal to the flow depth. This allows for large variations to occur in flow depth for steep channels caused by waves, splashing and surging. Lining materials should extend to the freeboard elevation.
- Check overall channel width for fitting within available alignment space, easement or right-of-way.

The following graphic depicts the decision flow chart for design of flexible channel linings.

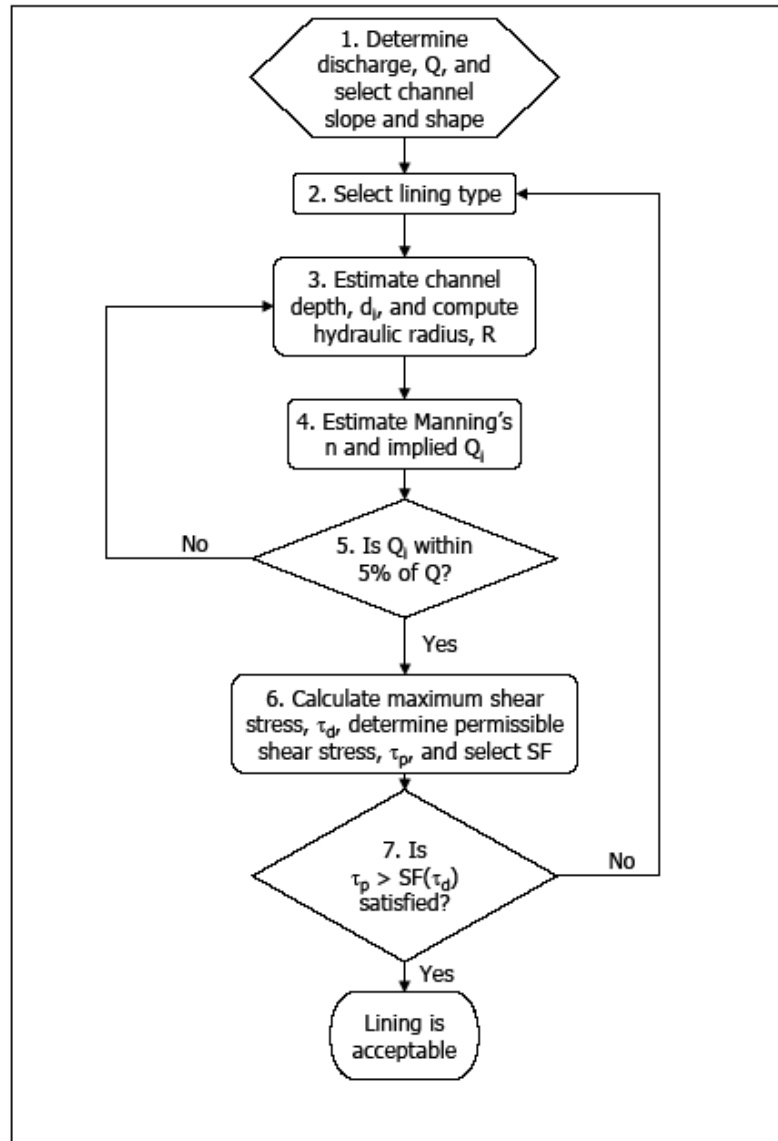

**Figure 7.27-1 Decision Flow Chart for Design of Flexible Channel Linings (Source: FHWA HEC 15)**

**Flexible channel liner design (mulch and grass, ECBs TRMs)**  
**FHWA HEC-15 Method:**

Step 1. Determine discharge,  $Q$ , and determine channel slope and shape. Channel geometry determines cross sectional area and hydraulic radius (see Equation 7.27-1). Hydraulic radius and cross sectional area equations for triangular or “vee” ditches, parabolic ditches and trapezoidal ditches is provided in Figure 7.27-2.

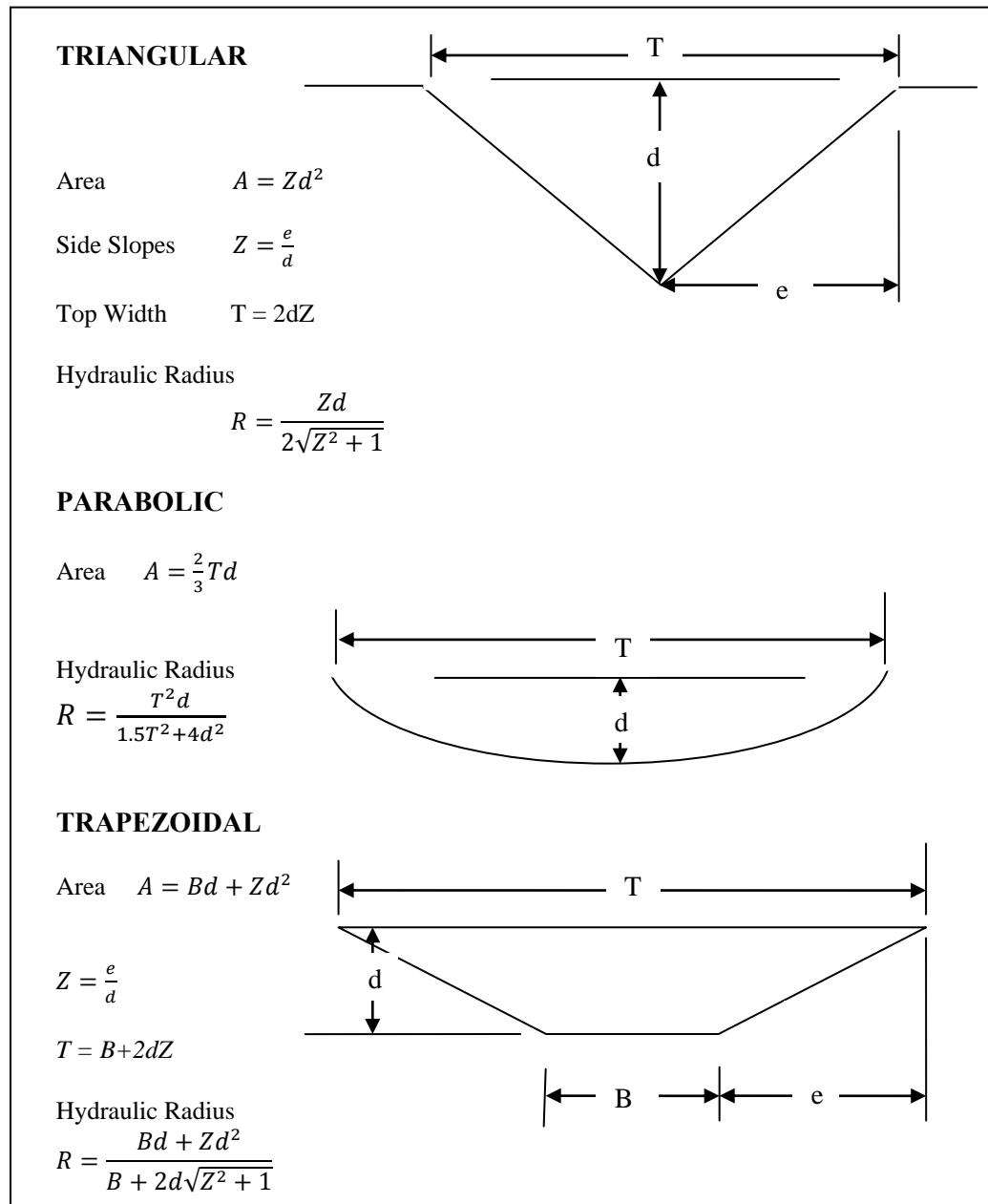

**Figure 7.27-2 Channel Geometry, Cross-sectional Area and Hydrologic Radius**

For determining flow, use Manning's equation:

$$Q = \frac{1.49}{n} AR^2 S_f^{1/2}$$

**Equation 7.27-1**

Where

Q = design discharge, ft<sup>3</sup>/sec

n = Manning's roughness coefficient, dimensionless

A = cross sectional area, ft<sup>2</sup>

R = hydraulic radius, ft

S<sub>f</sub> = friction gradient, which for uniform flow conditions equals the channel bed gradient, so, ft/ft

- Step 2. Select a trial lining type. Initially, the designer must determine if a long term lining is needed and whether or not a temporary or transitional lining is required. To determine if a temporary lining is required, the initial trial lining type should be bare soil. For example, it may be determined that the bare soil is insufficient for a long-term solution, but vegetation is a good solution. For the transitional period between construction and vegetative establishment, analysis of the bare soil will determine if a temporary lining is required. A trial lining allows an initial Manning's n to be estimated.
- Step 3. Estimate the depth of flow, d<sub>i</sub> in the channel and compute the hydraulic radius, R. The estimated depth may be based on physical limits of the channel, but this first estimate is essentially a guess. Iterations on steps 3 through 5 may be required.
- Step 4. Estimate Manning's n and the discharge implied by the estimated n and flow depth values. See Tables 7.27-1 and 7.27-2 depending on lining type of interest for Manning's n values. Calculate the discharge, Q<sub>i</sub>.

Note that Table 7.27-1 summarizes linings for which the n value is dependent on flow depth as well as the specific properties of the material. Values for rolled erosion control products (RECPs) are presented to give a rough estimate of roughness for the three different classes of products. Although there is a wide range of RECPs available, jute net, curled wood mat, and synthetic mat are examples of open-weave textiles, erosion control blankets, and turf reinforcement mats, respectively. Manufacturers of RECPs can provide more specific roughness coefficients as well.

Table 7.27-2 presents typical values for the stone linings: riprap, cobbles, and gravels. These are highly depth-dependent for roadside channel applications. More in-depth lining-specific information should be considered.



Table 7.27-1 Typical Roughness Coefficients for Selected Linings

Lining Category <sup>1</sup>	Lining Type	Manning's n		
		Maximum	Typical	Minimum
Rigid	Concrete	0.015	0.013	0.011
	Grouted Riprap	0.040	0.030	0.028
	Stone Masonry	0.042	0.032	0.030
	Soil Cement	0.025	0.022	0.020
	Asphalt	0.018	0.016	0.016
Unlined	Bare Soil	0.025	0.020	0.016
	Rock Cut (smooth, uniform)	0.045	0.035	0.025
RECP	Open-weave textile	0.028	0.025	0.022
	Erosion control blankets	0.045	0.035	0.028
	Turf reinforcement mat	0.036	0.030	0.024

<sup>1</sup>Minimum value accounts for grain roughness. Typical and maximum values incorporate varying degrees of form roughness.

Table 7.27-2 Typical Roughness Coefficients for Riprap, Cobble, and Gravel Linings

Lining Category	Lining Type	Manning's n for Selected Flow Depths <sup>1</sup>		
		0.5 ft	1.6 ft	3.3 ft
Gravel Mulch	D <sub>50</sub> = 1 in.	0.040	0.033	0.031
	D <sub>50</sub> = 2 in.	0.056	0.042	0.038
Cobbles	D <sub>50</sub> = 0.33 ft	- <sup>2</sup>	0.055	0.047
Rock Riprap	D <sub>50</sub> = 0.5 ft	- <sup>2</sup>	0.069	0.056
	D <sub>50</sub> = 0.33 ft	- <sup>2</sup>	- <sup>2</sup>	0.080

<sup>1</sup>Manning's n estimated assuming a trapezoidal channel with 1:3 side slopes and 2 ft bottom width.

<sup>2</sup>Shallow relative depth (average depth to D<sub>50</sub> ratio less than 1.5) and is slope-dependent.

Step 5. Compare  $Q_i$  with  $Q$ . If  $Q_i$  is within 5 percent of the design  $Q$  then proceed on to Step 6. If not, return to Step 3 and select a new estimated flow depth,  $d_{i+1}$ . This can be estimated from the following equation

$$d_{i+1} = d_i \left( \frac{Q}{Q_i} \right)^{0.4}$$

- Step 6. Calculate the shear stress at maximum depth,  $\tau_d$ , determine the permissible shear stress,  $\tau_p$ , and select an appropriate safety factor. Permissible shear stress for different linings is provided in Tables 7.27-3 through 7.27-8.

The maximum channel shear stress is taken as:

$$\tau_d = \gamma d S_o$$

where,

$\tau_d$  = shear stress in channel at maximum depth, lb/ft<sup>2</sup>

d = maximum depth of flow in the channel for the design discharge, ft

$S_o$  = channel bed slope, ft/ft

**Table 7.27-3 Typical Permissible Shear Stresses for Bare Soil and Stone Linings**

		Permissible Shear Stress $\tau_p$
Lining Category	Lining Type	lb/ft <sup>2</sup>
Bare Soil Cohesive (PI=10) <sup>1</sup>	Clayey sands	0.037-0.095
	Inorganic silts	0.027-0.11
	Silty sands	0.024-0.072
Bare Soil Cohesive <sup>1</sup> (PI≥20)	Clayey sands	0.094
	Inorganic silts	0.083
	Silty sands	0.072
	Inorganic clays	0.14
Bare Soil Non-cohesive (PI<10)	Finer than coarse sand D <sub>75</sub> <0.05 in	0.02
	Fine gravel D <sub>75</sub> =0.3 in	0.12
	Gravel D <sub>75</sub> =0.6 in	0.024
Gravel Mulch	Coarse gravel D <sub>50</sub> =1 in	0.4
	Very coarse gravel D <sub>50</sub> =2 in	0.8
Rock Riprap	D <sub>50</sub> =0.5 ft	2*
	D <sub>50</sub> ≥1.0 ft	4*

<sup>1</sup>Assuming a soil void ratio of 0.5

\* Assumes D<sub>50</sub> =  $\tau_p/4$

Table 7.27-4 Ultra Short Term Channel Liner Shear Stress

Typical 3-month functional longevity			
Type	Product Description	Material Composition	Max. Shear Stress $\tau_p$
1.A	Mulch Control Nets	A photodegradable synthetic mesh or woven biodegradable natural fiber netting.	0.25 lbs/ft <sup>2</sup>
1.B	Netless Rolled Erosion Control Blankets	Natural and/or polymer fibers mechanically interlocked and/or chemically adhered together to form a RECP.	0.5 lbs/ft <sup>2</sup>
1.C	Single-net Erosion Control Blankets & Open Weave Textiles	Processed degradable natural and/or polymer fibers mechanically bound together by a single rapidly degrading, synthetic or natural fiber netting or an open weave textile of processed rapidly degrading natural or polymer yarns or twines woven into a continuous matrix.	1.5 lbs/ft <sup>2</sup>
1.D	Double-net Erosion Control Blankets	Processed degradable natural and/or polymer fibers mechanically bound together between two rapidly degrading, synthetic or natural fiber nettings.	1.75 lbs/ft <sup>2</sup>

Table 7.27-5 Short Term Channel Liner Shear Stress

Typical 12-month functional longevity			
Type	Product Description	Material Composition	Max. Shear Stress $\tau_p$
2.A	Mulch Control Nets	A photodegradable synthetic mesh or woven biodegradable natural fiber netting.	0.25 lbs/ft <sup>2</sup>
2.B	Netless Rolled Erosion Control Blankets	Natural and/or polymer fibers mechanically interlocked and/or chemically adhered together to form a RECP.	0.5 lbs/ft <sup>2</sup>
2.C	Single-net Erosion Control Blankets & Open Weave Textiles	Processed degradable natural and/or polymer fibers mechanically bound together by a single rapidly degrading, synthetic or natural fiber netting or an open weave textile of processed rapidly degrading natural or polymer yarns or twines woven into a continuous matrix.	1.5 lbs/ft <sup>2</sup>
2.D	Double-net Erosion Control Blankets	Processed degradable natural and/or polymer fibers mechanically bound together between two rapidly degrading, synthetic or natural fiber nettings.	1.75 lbs/ft <sup>2</sup>

Table 7.27-6 Extended-Term Channel Liner Shear Stress

<b>EXTENDED-TERM - Typical 24-month functional longevity</b>			
Type	Product Description	Material Composition	Max. Shear Stress $\tau_p$
<b>3.A</b>	Mulch Control Nets	A slow degrading synthetic mesh or woven natural fiber netting.	0.25 lbs/ft <sup>2</sup>
<b>3.B</b>	Erosion Control Blankets & Open Weave Textiles	An erosion control blanket composed of processed slow degrading natural or polymer fibers mechanically bound together between two slow degrading synthetic or natural fiber nettings to form a continuous matrix or an open weave textile composed of processed slow degrading natural or polymer yarns or twines woven into a continuous matrix.	2.00 lbs/ft <sup>2</sup>

Table 7.27-7 Long-Term Channel Liner Shear Stress

<b>LONG-TERM - Typical 36 month functional longevity</b>			
Type	Product Description	Material Composition	Max. Shear Stress $\tau_p$
<b>4</b>	Erosion Control Blankets & Open Weave Textiles	An erosion control blanket composed of processed slow degrading natural or polymer fibers mechanically bound together between two slow degrading synthetic or natural fiber nettings to form a continuous matrix or an open weave textile composed of processed slow degrading natural or polymer yarns or twines woven into a continuous matrix.	2.25 lbs/ft <sup>2</sup>

**Table 7.27-8 Permanent Turf Reinforcement Channel Lining Shear Stress**

<b>PERMANENT Turf Reinforcement Mat - U.V. stability of 80%</b>			
Type	Product Description	Material Composition	Max. Shear Stress $\tau_p$
5.A	Turf Reinforcement Mat	Turf Reinforcement Mat (TRM) – A rolled erosion control product composed of non-degradable synthetic fibers, filaments, nets, wire mesh and/or other elements, processed into a permanent, three-dimensional matrix of sufficient thickness. TRMs, which may be supplemented with degradable components, are designed to impart immediate erosion protection, enhance vegetation establishment and provide long-term functionality by permanently reinforcing vegetation during and after maturation. Note: TRMs are typically used in hydraulic applications, such as high flow ditches and channels, steep slopes, stream banks, and shorelines, where erosive forces may exceed the limits of natural, unreinforced vegetation or in areas where limited vegetation establishment is anticipated.	6.0 lbs/ft <sup>2</sup>
5.B	Turf Reinforcement Mat		8.0 lbs/ft <sup>2</sup>
5.C	Turf Reinforcement Mat		10.0 lbs/ft <sup>2</sup>

Step 7. Compare the permissible shear stress to the calculated shear stress from step 6. If  $\tau_p \geq \tau_d$ , then the channel lining is adequate. If the permissible shear stress is inadequate, then return to Step 2 and select an alternative lining type with greater permissible shear stress. As an alternative, a different channel shape may be selected that results in a lower depth of flow.

### Channel Bend Analysis

Flow around a bend creates secondary currents, which impose higher shear stresses on the channel sides and bottom compared to a straight reach (Nouh and Townsend, 1979) as shown in Figure 7.27.3. At the beginning of the bend, the maximum shear stress is near the inside and moves toward the outside as the flow leaves the bend. The increased shear stress caused by a bend persists downstream of the bend.

The following procedure should be used to select an adequate lining for a channel in a bend section. It assumes that the channel has already been designed for the straight sections. First, the required lining and the length of the channel that must be reinforced is determined. After the channel lining has been checked for stability, the capacity of the bend section is analyzed.



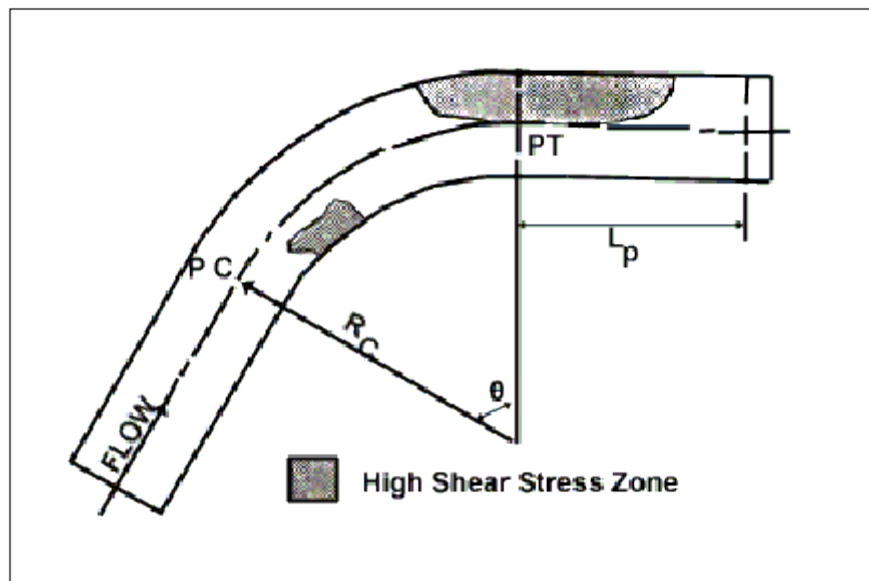

Figure 7.27-3 Shear Stress Distribution in a Channel Bend  
(Nouh and Townsend, 1979)

Step 1. Determine the value of the ratio  $\frac{R_c}{B}$ , where  $R_c$  is the radius of curvature, and  $B$  is the channel width.

Step 2. Calculate  $K_b$  as follows:

$$\text{Where } R_c/T \leq 2 \quad K_b = 2.00$$

$$\text{Where } 2 < R_c/T < 10 \quad K_b = 2.38 - 0.206 \left( \frac{R_c}{T} \right) + 0.0073 \left( \frac{R_c}{T} \right)^2$$

$$\text{Where } 10 \leq R_c/T \quad K_b = 1.05$$

Step 3. Calculate the shear stress in the channel bend using the following equation.

$$\tau_b = K_b \tau_d$$

where,

$\tau_d$  = maximum shear stress in the straight section of the channel

If  $\tau_b$  is greater than the permissible shear stress for the selected channel lining, then a different lining is required for the channel bend. Select a new lining (and corresponding Manning's coefficient), and repeat the previous procedures to demonstrate stability.

Step 4. Calculate the required length of lining. The channel lining in the bend section should be installed from the beginning of the bend, all the way through the bend, and downstream a distance  $L_p$  determined in the following equation:

$$L_p = 0.604 \left( \frac{R^{1/6}}{n_b} \right) R$$

where,

R = hydraulic radius, ft

$n_b$  = Manning's roughness coefficient in the bend

- Step 5. Check the capacity in the bend. First, calculate the velocity in the bend using Manning's Equation (Equation 7.27-1). This should be done using the roughness coefficient for the final condition of the channel (i.e. fully vegetated, instead of just a temporary blanket). Then calculate the super elevation in the bend with the following equation:

$$\Delta h = \frac{V^2 T}{g R_c}$$

where,

V = velocity, ft/s

T = top width of the channel, ft

g = acceleration due to gravity, 32.2 ft/s<sup>2</sup>

$R_c$  = radius of curvature of the bend, ft

$\Delta h$  is the difference between the inside and outside depths at the superelevation in the bend.

The design depth of the channel in the bend section must be capable of conveying an extra height  $\Delta h/z$  in addition to the flow depth calculated for the straight section. If the depth is insufficient, the channel geometry must be modified and the calculations performed again.

### Rip rap channel lining design

The design process for riprap-lined ditches is iterative, as flow depth, roughness, and shear stress are interdependent. It is assumed that the designer begins this procedure with the channel shape, slope, and design flow rate. From there, a preliminary  $D_{50}$  is determined for the rip rap, and the design depth and Manning's 'n' are calculated.

- Step 1 Determine discharge, Q, and determine channel slope and shape. Channel geometry determines cross sectional area and hydraulic radius (see Equation 7.27-1). The side slopes of a riprap-lined channel should not be steeper than 3H:1V (Z should be  $\geq 3$ ).
- Step 2 Select a trial  $D_{50}$  based on previous experience and available stone sizes for the project. Refer to Table 7.20-1 TDOT Rip Rap Classification and Sizes for standard riprap classes in Tennessee.
- Step 3 Assume an initial trial depth. For the first iteration, select a channel depth,  $d_i$ . For subsequent iterations, a new depth can be estimated from the following equation:

$$d_{i+1} = d_i \left( \frac{Q}{Q_i} \right)^{0.4}$$

Equation 7.27-2

Determine Area (A), Hydraulic Radius (R), and Top Width (T) using the equations shown in Figure 7.27-2.

Determine the average flow depth,  $d_a$ , in the channel using the following relationship:  $d_a = A/T$

After calculating  $d_a$ , recalculate A, R, and T at this depth to get your Average Area (Aa), Average Hydraulic Radius (Ra), and Average Top Width (Ta).

Step 4

Calculate Manning's roughness coefficient, 'n'. First, calculate the relative depth ratio,  $d_a/D_{50}$ . If  $d_a/D_{50}$  is greater than or equal to 1.5, use Equation 7.27-3 to calculate Manning's 'n'. If  $d_a/D_{50}$  is less than 1.5, use Equation 7.27-4.

$$n = \frac{\alpha d_a^{1/6}}{2.25 + 5.23 \log\left(\frac{d_a}{D_{50}}\right)}$$

Equation 7.27-3

where,

n = Manning's roughness coefficient, dimensionless

$d_a$  = average flow depth in the channel, ft

$D_{50}$  = median riprap size, ft

$\alpha$  = unit conversion constant, 0.262 (CU)

$$n = \frac{\alpha d_a^{1/6}}{\sqrt{g} f(Fr) f(REG) f(CG)}$$

Equation 7.27-4

where,

$\alpha$  = unit conversion constant, 1.49 (CU) and 1.0 (SI)

n = Manning's roughness coefficient, dimensionless

$d_a$  = average flow depth in the channel, ft

g = acceleration due to gravity, 32.2 ft/s<sup>2</sup>

$f(Fr)$  = Froude number (see Equation 7.27-5 below)

$f(REG)$  = roughness element geometry (see Equation 7.27-6)

$f(CG)$  = channel geometry (see Equation 7.27-7)

$$f(Fr) = \left( \frac{0.28Fr}{b} \right)^{\log(0.755/b)}$$

Equation 7.27-5

$$f(REG) = 13.434 \left( \frac{T}{D_{50}} \right)^{0.492} b^{1.025(T/D_{50})^{0.118}}$$

Equation 7.27-6

$$f(CG) = \left( \frac{T}{d_a} \right)^{-b}$$

Equation 7.27-7

The following variables are necessary for the above equations:

T = channel top width, ft (see Figure 7.27-2)

b = parameter describing the effective roughness coefficient (see Equation 7.27-9)

v = Q/A<sub>a</sub>, ft/s

A<sub>a</sub> = Area at d<sub>a</sub> (see Step 3)

$$Fr = \frac{v}{\sqrt{g d_a}}$$

Equation 7.27-8

$$b = 1.14 \left( \frac{D_{50}}{T} \right)^{0.453} \left( \frac{d_a}{D_{50}} \right)^{0.814}$$

Equation 7.27-9

- Step 5 Calculate the discharge for this iteration using Manning's equation with the d<sub>a</sub> from Step 3. If the calculated discharge is within 5% of the design discharge, continue to Step 6. Otherwise, return to Step 3 and select a new flow depth.
- Step 6 Calculate the particle Reynolds number, R<sub>e</sub>, using Equation 7.27-10, then determine the appropriate Shield's parameter, F\*, and safety factor, SF, values from Figure 7.27-4.

$$R_e = \frac{\sqrt{gdS} D_{50}}{v}$$

Equation 7.27-10

Where,

g = acceleration due to gravity, 32.2 ft/s<sup>2</sup>

d = maximum channel depth, ft (d<sub>a</sub> + minimum freeboard of 0.5')

S = channel slope, ft/ft

v = kinematic viscosity, 1.217x10<sup>-5</sup> ft<sup>2</sup>/s at 60°F

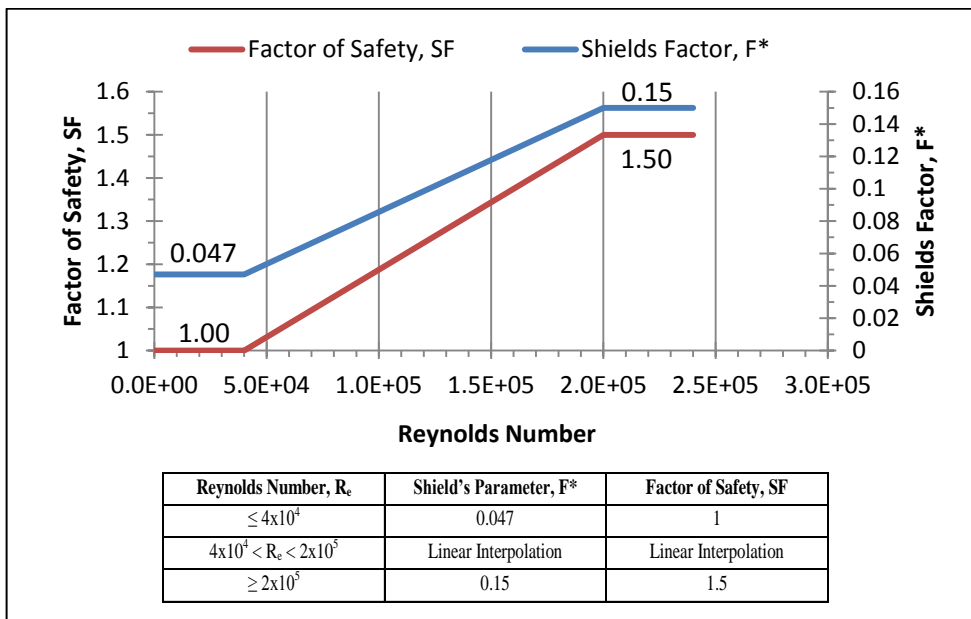

Figure 7.27-4 Reynolds Number, Shield's Parameter and Factor of Safety Values

Step 7 Calculate the required  $D_{50}$ . For channel slopes less than 5%, use Equation 7.27-11. For channel slopes greater than 10%, use Equation 7.27-12. For channel slopes between 5 and 10%, use both equations and choose the larger outcome.

$$D_{50} \geq \frac{SF d S}{F^* \left(\frac{\gamma_s}{\gamma} - 1\right)}$$

Equation 7.27-11

$$D_{50} \geq \frac{SF d S \Delta}{F^* \left(\frac{\gamma_s}{\gamma} - 1\right)}$$

Equation 7.27-12

where,

SF = Safety factor (from Figure 7.27-4)

d = maximum channel depth, ft ( $d_a$  + minimum freeboard of 0.5')

S = channel slope, ft/ft

$F^*$  = Shield's parameter (from Figure 7.27-4)

$\gamma_s$  = specific weight of rock, lb/ft<sup>3</sup>

$\gamma$  = specific weight of water, 62.4 lb/ ft<sup>3</sup>

$\Delta$  = function of channel geometry and riprap size (see Equation 7.27-13)

If the specific weight,  $\gamma$ , of the available stone is known, it should be used. Otherwise, a typical value of 165 lb/ft<sup>3</sup> may be selected.



$$\Delta = \frac{K_1(1+\sin(\alpha+\beta)) \tan \phi}{2(\cos \theta \tan \phi - SF \sin \theta \cos \beta)}$$

where,

$\alpha$  = angle of the channel bottom slope

$\beta$  = angle between the weight vector and the weight/drag resultant vector in the plane of the side slope (see Equation 7.27-14)

$\phi$  = angle of repose for the riprap

$\theta$  = angle of the channel side slope

$K_1 = .77 (Z \leq 1.5)$

$= 0.066Z + 0.67 (1.5 < Z < 5)$

$= 1.0 (Z \geq 5)$

Equation 7.27-13

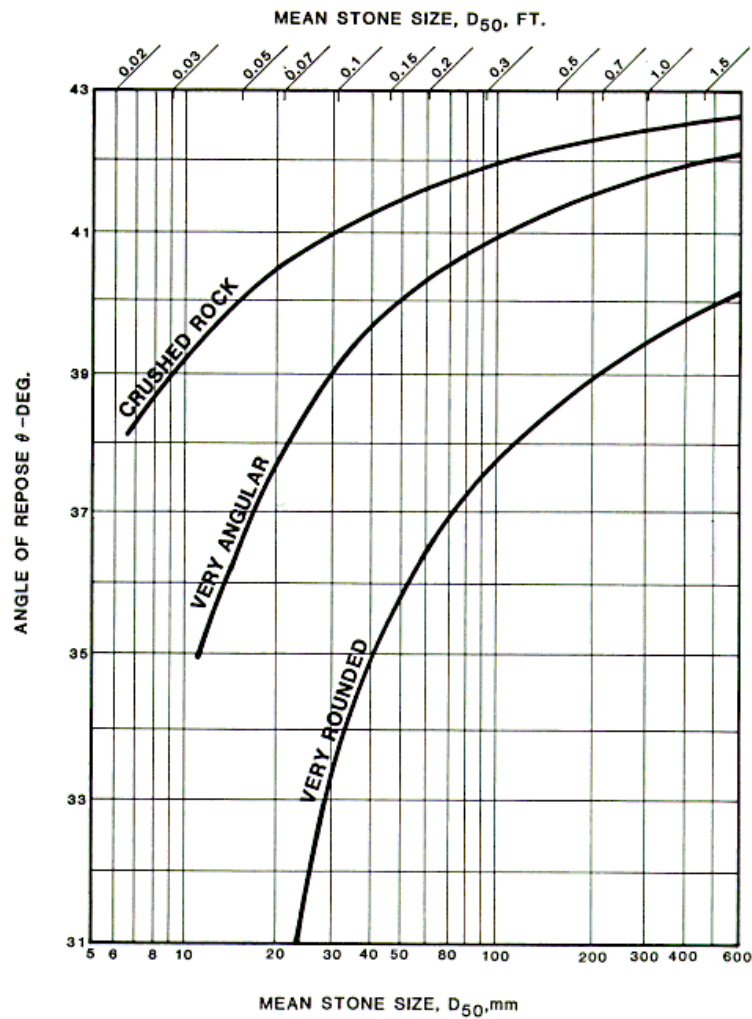

Figure 7.27-5 Angle of Repose of Riprap in Terms of Mean Size and Shape of Stone

$$\beta = \tan^{-1} \left( \frac{\cos \alpha}{\frac{2 \sin \theta}{\eta \tan \phi} + \sin \alpha} \right)$$

Equation 7.27-14

where,  
 $\eta$  = stability number:

$$\eta = \frac{\tau_s}{F^* (\gamma_s - \gamma) D_{50}}$$

Equation 7.27-15

where,  
 $\tau_s$  = shear stress for  $d_a$

$$\tau_s = \gamma d_a S_o$$

Equation 7.27-16

- Step 8 Compare the required  $D_{50}$  to the trial size selected in Step 2. If the trial size is smaller than the required size, it is unacceptable for the design. Repeat the procedure from Step 2, selecting a larger trial size. If the trial size is larger than the required  $D_{50}$ , then the design is acceptable. However, if the required  $D_{50}$  is sufficiently smaller than the trial size, the procedure may be repeated from Step 2 with a smaller, more cost-effective stone size.

### Construction Specifications

#### For grass lined channels, with RECPs or TRMs:

RECPs and TRMs should be selected and designed according to manufacturer's specifications and allowable shear stresses and velocities to withstand actual design flow shear stresses and velocities.

Prepare a stable and firm soil surface free of rocks and other obstructions. Apply soil amendments as necessary to prepare seedbed. Place fertilizer, water, and seed in accordance with manufacturer, local/state regulations, or engineer/specifiers requirements. Typically, RECPs are unrolled parallel to the primary direction of flow. Ensure the product maintains intimate contact with the soil surface over the entirety of the installation. Do not stretch or allow material to bridge over surface inconsistencies. Staple/stake RECPs to soil such that each staple/stake is flush with underlying soil. Install anchor trenches, seams and terminal ends as specified.

Install RECPs after application of seed, fertilizer, mulches (if necessary) and other necessary soil amendments, unless soil in-filling of the TRM is required. For TRMs if soil in-filling, install TRM, apply seed, and other soil amendments lightly brush or rake 0.3 to 0.7 inches of topsoil into TRM matrix to fill the product thickness. If in-filling with a hydraulically-applied matrix or medium is required; install

TRM, then install hydraulically-applied matrix or medium at the manufacturer's suggested application rate.

Construct an anchor trench at the beginning of the channel across its entire width. Excavate a 6 in. by 6 in. anchor trench. Extend the upslope terminal end of the RECPs 3 ft. past the anchor trench. Use stakes or staples to fasten the product into the bottom of the anchor trench on 1 ft. centers. Backfill the trench and compact the soil into the anchor trench. Apply seed and any necessary soil amendments to the compacted soil and cover with remaining 1 ft. terminal end of the RECPs. Fold product over compacted soil in anchor trench to overlap downslope material. Secure terminal end of RECPs with a single row of stakes or staples on 1 ft. centers.

Follow the manufacturer's installation guidelines in constructing additional anchor trenches or stake/staple check slots at intervals along the channel reach and at the terminal end of the channel. Unroll RECPs down the center of the channel in the primary water flow direction. Securely fasten all RECPs to the soil by installing stakes/staples at a minimum rate of 1.7/yd<sup>2</sup>. Significantly higher anchor rates and longer stakes/staples may be necessary in sandy, loose, or wet soils and in severe applications.

**Seams.** For adjacent and consecutive rolls of RECPs, utilize one of the methods detailed below for seaming of RECPs:

1. **Adjacent seams.** Overlap edges of adjacent RECPs by 2 to 4 inches or by abutting products as defined by manufacturer. Use a sufficient number of stakes or staples to prevent seam or abutted rolls from separating.
2. **Consecutive rolls.** Shingle and overlap consecutive rolls 2 to 6 inches in the direction of flow. Secure staples through seam at 1 ft. intervals.
3. **Check seam.** Construct a stake/staple check seam along the top edge of RECPs for slope application and at specified intervals in a channel by installing two staggered rows of stakes/staples 4 inches apart on 4 inch centers.
4. **Slope interruption check slot.** Excavate a trench measuring 6 in. wide by 6 in. deep. Secure product to the bottom of the trench. Fold product over upslope material and fill and compact the trench on the downslope side of check slot and seed fill. Continue rolling material downslope over trench.

**Terminal ends.** All terminal ends of the RECPs must be anchored using one of the methods below:

1. **Staples.** Install the RECPs 3 ft. beyond the end of the channel and secure end with a single row of stakes/staples on 1 ft. centers. Stakes/staples for securing RECPs to the soil are typically 6 in. long.
2. **Anchor trench.** Excavate a 6 in. by 6 in. anchor trench. Extend the terminal end of the RECPs 3 ft. past the anchor trench. Use stakes or staples to fasten the product into the bottom of the anchor trench on 1 ft. centers. Backfill the trench and compact the soil into the anchor trench. Apply seed and any necessary soil amendments to the compacted soil and cover with remaining 1 ft. terminal end of the RECPs. Secure terminal end of RECPs with a single row of stakes or staples on 1 ft. centers.

3. **Check slot.** Construct a stake/staple check slot along the terminal end of the RECPs by installing two rows of staggered stakes/staples 4 in. apart on 4 in. centers.

With any RECP installation, ensure sufficient staples to resist uplift from hydraulics, wind, mowers, and foot traffic. For the most effective installation of RECPs, the ECTC recommends using stake/staple patterns and densities as recommended by the manufacturer.

**For riprap lined channels:**

**Subgrade preparation** – Prepare the subgrade for riprap and filter to the required lines and grades shown on the plans. Remove brush, trees, stumps, and other objectionable material. Cut the subgrade sufficiently deep that the finished grade of the riprap will be at the elevation of the surrounding area. Channels should be excavated sufficiently to allow placement of the riprap in a manner such that the finished inside dimensions and grade of the riprap meet design specifications. Place filters and beddings to line and grade in the manner specified.

**Synthetic filter fabric** – Used to separate rock from underlying soil bed. Place the cloth filter directly on the prepared foundation. Overlap the edges by at least 12 inches, and space anchor pins every 3 ft along the overlap. Bury the upstream end of the cloth a minimum of 12 inches below ground and where necessary, bury the lower end of the cloth or overlap with the next section as required. Take care not to damage the cloth when placing riprap. If damage occurs remove the riprap, and repair the sheet by adding another layer of filter material with a minimum overlap of 12 inches around the damaged area. If extensive damage is suspected, remove and replace the entire sheet.

**Riprap placement** – Riprap should be placed so it is flush with the surrounding ground, to the depth specified in the design plans. See Figure 7.27-6 for the correct installation of riprap lining in channels.

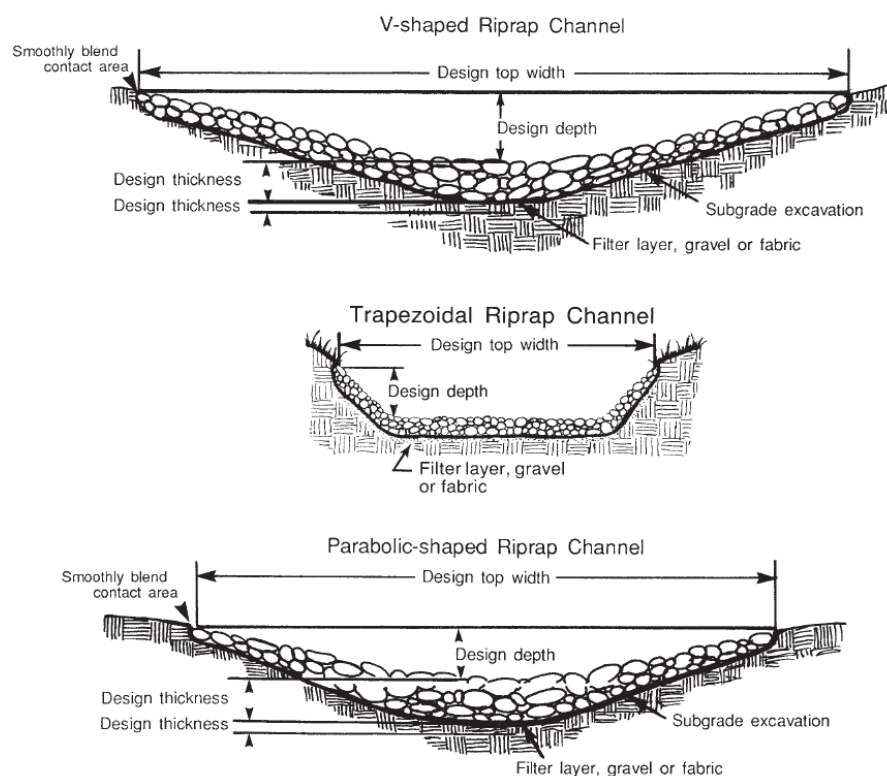

**Figure 7.27-6 Construction details for riprap lined channels**

**Maintenance  
and Inspection  
Points**

For channels lined with RECPs, repair any damaged areas immediately by restoring soil to finished grade, re-applying soil amendments and seed, and replacing the RECPs.

For riprap lining, repair any areas of erosion or displacement of rock.

Protect stabilized channels from areas of active construction.

Check the channel outlet and all road crossings for bank stability and evidence of piping or scour holes. Remove all significant sediment accumulations to maintain the designed carrying capacity. Keep the grass in a healthy, vigorous condition at all times, since it is the primary erosion protection for the channel. If continuous destabilization or erosion occurs, an alternative channel lining may be needed.

**References**

*North Carolina Erosion and Sediment Control Planning and Design Manual*

*Erosion Control Technology Council RECP Specifications*

*Federal Highways Administration HEC 15, Design of Roadside Channels with Flexible Linings*

## SEDIMENT CONTROL PRACTICES

### 7.28 CONSTRUCTION EXIT

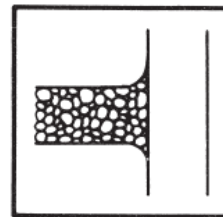

GRAVEL CONSTRUCTION EXIT

- Definition** A stone pad on geotextile fabric or a rumble strip located at any point where traffic will be moving from a construction site onto a public roadway or other paved area.
- Purpose** To reduce or eliminate the transport of material from the construction area onto a public roadway by providing an area where mud and soil can be removed from the tires of construction vehicles.
- Conditions Where Practice Applies** This practice is applicable wherever construction traffic leaves a construction site and enters a public right of way.
- Planning Considerations** Construction exits should be planned and installed at any point that construction traffic exits the project. These stone pads should not be placed in areas with hydric or saturated soils.
- Stormwater management must be considered around the construction exit as well.
- Avoid steep grades and exits in or near curves in public roads.
- Design Criteria** Calculations are not required; however, a typical construction exit should conform to the specifications listed below.
- A layer of geotextile fabric is required to stabilize and support the aggregate. The geotextile fabric should extend the full length and width of the construction exit. The fabric should meet the requirements of the standard specifications for geotextiles, AASHTO designated M-288, erosion control.
  - The stone pad should be constructed from clean, washed stone with a 2 inch to 4 inch gradation at a minimum thickness of 8 inches. At a minimum, the stone pad should be 50 feet long and 20 feet wide. In addition a turning radius of 20 feet should be provided on each side of the pad where it intersects with the public roadway. See Figures 7.28-1 and -2.
  - The area where the pad is to be installed must be undercut at least 3 inches, and then the geotextile fabric should be installed before placing the stone.



### Construction Specifications

- Stormwater management around the construction exit must be taken into consideration. If stormwater runoff flows across the stone pad and onto the public right of way, mud on the pad can be washed into the ROW as well. Diversions or waterbars should be installed at the upgradient end of the pad, directing runoff into sediment traps for treatment prior to discharging runoff into the ROW.
- Excavate areas where construction exits are to be constructed to a depth of at least 3 inches and clear the area of all vegetation, roots, and other objectionable material.
- Construction exit areas should be at minimum 50 feet in length by 20 feet in width.
- Install a geotextile underliner across the full width and depth of the construction exit to separate the rock from underlying soil.
- Provide clean, washed stone to a depth of 8 inches. Stone should vary in size from 2 to 4 inches. Rock must be clean rock with no fines. Crusher run and road base are not acceptable materials for a construction exit, as the fines can be tracked out onto the road.

#### Waterbar Diversion:

On sites where the grade toward the public roadway is greater than 2%, a waterbar diversion 6 to 8 inches in depth with 3:1 side slopes should be constructed at the upper end of the construction exit to prevent stormwater from washing sediment off the construction exit and into the public roadway or storm drain system. See Figure 7.28-1. Other devices, such as berms also may be used to divert stormwater from flowing down the construction exit and onto the public ROW.

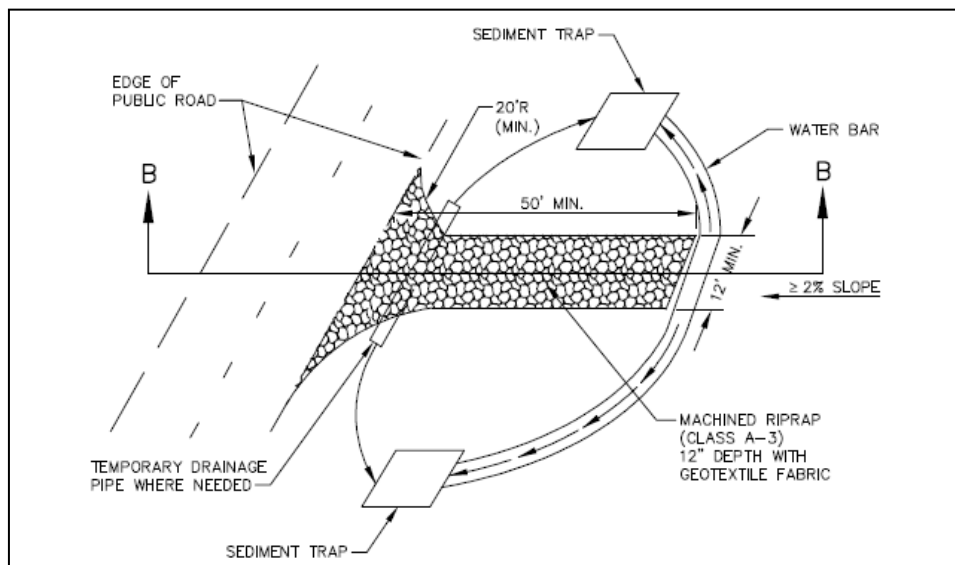

Figure 7.28-1 Construction Exit with Water Bars

**Maintenance and Inspection Points** The exit must be maintained in a condition that will prevent tracking or flow of material onto public rights-of-way or into the storm drain system. This may require periodic top dressing with fresh stone or full replacement of stone as conditions demand, and repair and/or cleanout of any related diversions and sediment traps. All materials spilled, dropped, washed, or tracked from vehicles or site onto roadways or into storm drains must be removed by the end of the day.

**References** *TDOT Design Division Drainage Manual*  
*North Carolina Erosion and Sediment Control Planning and Design Manual*

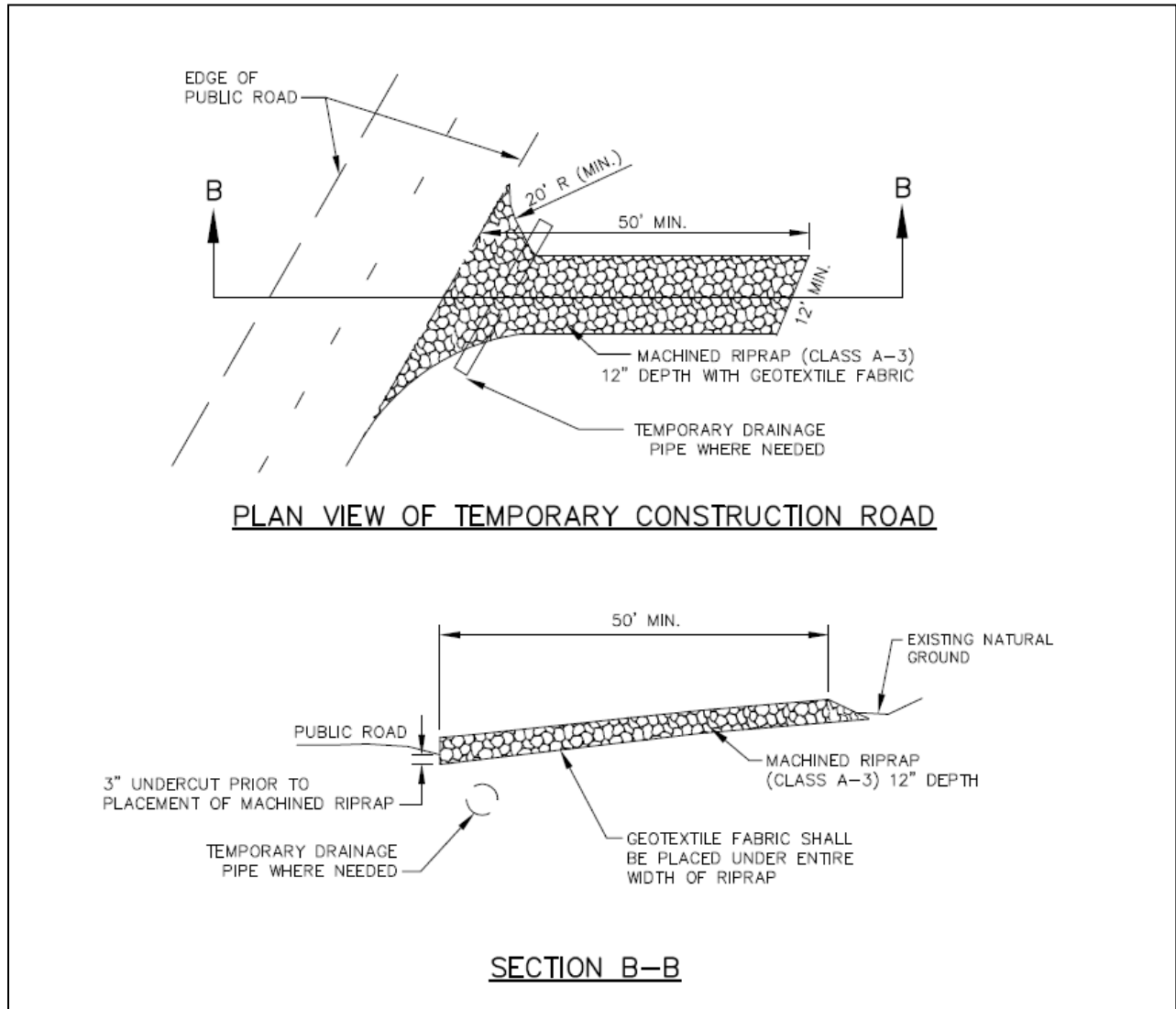
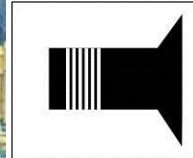

Figure 7.28-2 Construction Exit Detail

## SEDIMENT CONTROL PRACTICES

### 7.29 TIRE WASHING FACILITY



TIRE WASHING FACILITY

**Definition** A station for washing tires prior to construction traffic exiting the construction site. Used in conjunction with a gravel construction exit to remove sediment from tires and undercarriages.

**Purpose** To prevent or reduce the discharge of pollutants as a result of vehicular egress from the construction site by providing facilities that remove mud and dirt from vehicle tires and undercarriages with sprayed water prior to entering public roads.

**Conditions Where Practice Applies** Tire washing facilities are used in addition to gravel construction exits where typical gravel construction exits do not provide sufficient dirt and mud removal from construction equipment. Tire washes are not necessary in all cases but should be considered for sites located in sensitive areas or where track out cannot be controlled with typical gravel construction exits.

**Planning Considerations** Tire washing requires a supply of water either by overhead tank, pressurized tank or by water pipeline. All wash water should drain into a sediment-trapping device such as a sediment basin or sediment trap before discharging off the construction project.

If chlorinated water (such as ordinary tap water or hydrant water) is used, allow the water to sit for 24 hours, to allow chlorine to dissipate into the air, prior to discharging effluent to a stream. Effluent may be checked by a standard pool test kit to verify that it is chlorine-free.

A turnout or an extra-wide exit may be necessary to avoid entering vehicles from driving through the tire wash rack area (which is only intended for exiting vehicles).

- Design Criteria**
- Wash racks should be designed and constructed/manufactured for anticipated traffic loads.
  - Provide a drainage ditch that will convey the runoff from the wash area to a sediment trapping device. The drainage ditch should be of sufficient grade, width, and depth to carry the wash runoff. Refer to sediment trap and channel design sheets, 7.32 Sediment Traps and 7.27 Channels.

- Construction Specifications**
- Incorporate with a stabilized construction entrance/exit.
  - Construct on level ground when possible, on a pad of coarse aggregate greater than 3 in. but smaller than 6 in. A geotextile fabric should be placed below the aggregate.
  - Use hoses with automatic shutoff nozzles to prevent hoses from being left on.
  - Require that all employees, subcontractors, and others that leave the site with mud caked tires and undercarriages to use the wash facility.
  - Post signage at tire washing facilities or designate personnel to oversee traffic exiting the construction site at tire washing facility locations.

**Maintenance and Inspection Points** Remove accumulated sediment in tire wash rack and sediment traps as necessary to maintain system performance. Inspect routinely for damage and repair as needed.

**References** *California Stormwater Best Management Practices Handbook*  
*City of Knoxville Best Management Practices Manual*

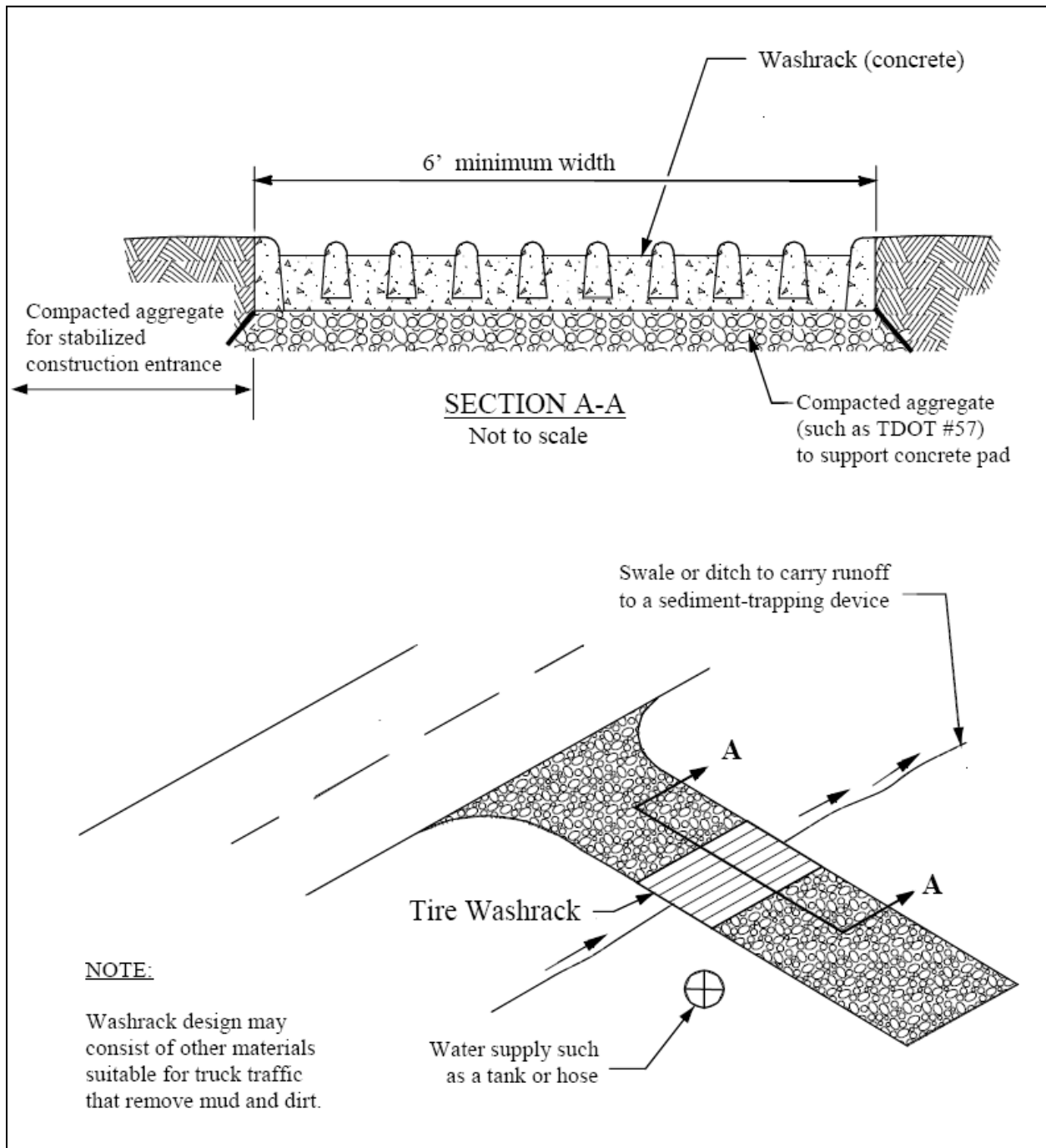

Figure 7.29-1 Tire Wash Rack (Source: City of Knoxville)



## SEDIMENT CONTROL PRACTICES

### 7.30 FILTER RING



FILTER RING

**Definition** A temporary sediment control constructed of riprap and installed at storm drain and culvert inlets.

**Purpose** To reduce flow velocities and prevent the failure of other sediment control devices. It also prevents sediment from entering, accumulating in, and being transferred by a culvert or storm drainage system prior to stabilization of the disturbed area. This practice allows early use of the storm drainage system.

**Conditions Where Practice Applies** This practice should be used in combination with other sediment control measures. They can be installed at or around devices such as storm drain inlets or slope drain inlets.

**Planning Considerations** When construction on a project reaches a stage where culverts and other storm drainage structures are installed and many areas are brought to the desired grade, there is a need to protect the points where runoff can leave the site through culverts or storm drains. Similar to drop and curb inlets, culverts receiving runoff from disturbed areas can convey large amounts of sediment to lakes or streams. Even if the pipe discharges into a sediment trap or basin, the pipe or pipe system itself may clog with sediment. Although filter rings may slow runoff entering into a storm drain inlet or culvert, they should not divert water away from the storm drain.

**Design Criteria** **Location:**  
The filter ring should surround all sides of the structure receiving runoff from disturbed areas. See Figure 7.30-1 for a typical filter ring. It should be placed a minimum of 4 feet from the structure. The ring should be constructed so that it does not cause flooding or damage to adjacent areas.

**Stone Size:**

When utilized at inlets/outlets with diameters less than 12 inches, the filter ring should be constructed of small riprap such as TDOT Class A-3 (clean from fines) with stone sizes from 2 to 6 inches.

When utilized at inlets with diameters greater than 12 inches, the filter ring should be constructed of a small riprap such as TDOT Class A-1 (clean from fines) with stone sizes from 2 to 15 inches.

For added sediment filtering capabilities, the upstream side of the riprap can be faced with smaller coarse aggregate, such as TDOT #57 (clean of fines) with a minimum stone size of  $\frac{3}{4}$  inch.

**Geotextiles:**

A geotextile should be used as a separator between the graded stone and soil base and abutments. The geotextile will prevent the migration of soil particles from the subgrade into the graded stone. Geotextiles should be set into the subgrade soils. The geotextile should be placed immediately adjacent to the subgrade without any voids and extend to beneath the inlet to prevent scour within the filter ring.

**Height:**

The filter ring should be constructed at a height of two feet with slopes no steeper than 2:1.

**Construction Specifications**

- Clear the area of all debris that might hinder excavation and disposal of soil.
- Install the Class A riprap in a semi-circle or ring around the inlet or outlet. The stone should be built up higher on each end where it ties into the embankment. The minimum crest width of the riprap should be 1.5 feet, with a minimum bottom width of 11 feet. The minimum height should be 2 feet.
- A 1 foot thick layer of No. 57 stone should be placed on the outside slope of the riprap.
- The sediment storage area should be excavated around the outside of the filter ring 12 inches below natural grade.
- When the contributing drainage area is stabilized, fill the depression and establish final grade elevations, compact the area properly, and stabilize with groundcover.

**Maintenance and Inspection Points**

The filter ring must be kept clear of trash and debris. Sediment should be removed when the level reaches one half the height of the filter ring. These structures are temporary and should be removed when the land disturbing project has been stabilized.

**References**

*North Carolina Erosion and Sediment Control Planning and Design Manual*

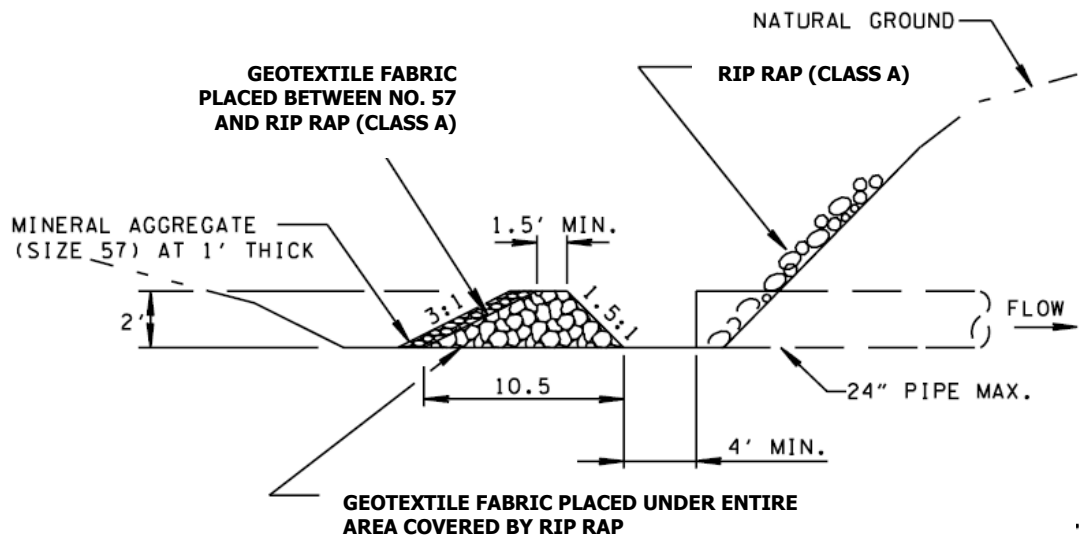

Figure 7.30-1 Filter Ring Detail (Source: TDOT Standard Drawing)

## SEDIMENT CONTROL PRACTICES

### 7.31 SEDIMENT BASIN



SEDIMENT BASIN

**Definition** A temporary basin created by an embankment constructed across a drainage way, or by an excavation that creates a basin, or by a combination of both, suitably located to capture sediment. A sediment basin consists of an embankment (dam), a sediment storage area, a sediment forebay, a dewatering mechanism, a principal (or primary) spillway and emergency spillway system, a permanent pool, and scour protection at the outlet of the principal spillway pipe.

**Purpose** To capture and retain sediment on the construction site, and to prevent sedimentation in off-site streams, lakes, and drainageways. Given the likelihood that the storm water peak flow from the active construction site will exceed the pre-construction peak flow, a sediment basin can also function as a peak flow attenuation measure during construction to protect the downstream channel from damage due to erosion and sedimentation. Temporary sediment basins may be used to limit post-construction discharges to pre-construction conditions for one or more storm frequency events, as required by local regulations.

**Conditions Where Practice Applies** Sediment basins, or equivalent measures, are required where:

- The total drainage area at an outfall from a construction site is ten (10) acres or greater for sites draining into unimpaired streams and waters
- The total drainage area at an outfall from a construction site that discharges into Impaired or Exceptional TN Waters, as defined by TDEC, where the total drainage area is five (5) acres or more.
- Sediment basins should also be installed at outfall points that do not meet the criteria above, but where treatment of sediment-laden runoff is necessary.

Sediment basins are **not** to be located in streams.

**Planning Considerations**

Sediment basins should be carefully located to capture sediment from all areas not treated adequately by other sediment controls. Basins are one part of an overall sediment control treatment train. The choice of construction materials for the sediment basin shall be based upon the basin's design life, which is typically 18 to 30 months.

Access for cleanout and disposal must be considered when choosing the location of a basin. Locations where a small pond can be formed by construction of a low dam across a natural swale are generally preferred to areas that require excavation.

Sediment basins may be located in areas where permanent detention or retention ponds are located; however they must be properly cleaned before converting the basin into a permanent pond. If a sediment basin is located in the same location as a permanent detention pond, then the permanent outlet structure should not be installed until all sediment is cleaned from the sediment basin, the proper grades are established in the detention area, and the basin is fully stabilized.

The size and performance of any sediment basin depends on several factors: (1) shape of the basin, (2) soil properties, (3) runoff volume and peak flow, (4) water chemistry, (5) permanent vs. dry basin design, (6) dewatering the "dry" or temporary storage following a storm, (7) effective erosion prevention practices, (8) effective inspection and maintenance, including pond cleaning, (9) quality of construction practices, and (10) whether the basin side slopes are stabilized. Basins should not be regarded as a single solution to erosion prevention and sediment control on a construction site. Instead, basins should always be used in conjunction with primary controls and stabilizing practices (as found throughout this manual) such as temporary vegetation, mulching, diversion dikes, etc. designed to prevent or reduce the possibility of soil from being eroded in the first place.

Sediment basins should be installed before any land-disturbance takes place within the drainage area. Where practical, sediment-free runoff should be diverted away from the basin.

Sediment basins must be designed by either a professional engineer or a landscape architect, trained in the design of impoundment structures, and in accordance with good engineering practices. Sediment basins must be designed and constructed in accordance with all applicable state and local laws, ordinances, permit requirements, rules, and regulations. Tennessee dam safety regulations apply if the dam height and/or pond volume meet or exceed specified limits provided below.

Embankments must comply with the Tennessee Safe Dams Act of 1973, as amended, if **either** of the following two conditions exist:

- a. the embankment is twenty feet or more in height, or
- b. the impoundment will have a capacity, at maximum water storage elevation, of thirty (30) acre-feet (48,400 CY) or more.

Any such dam which is equal to or less than six feet in height, regardless of storage capacity, or which has a maximum storage capacity not in excess of fifteen (15) acre-feet (24,200 cy/yds), regardless of height, would not be regulated under the Safe Dams Act. If basins and dams meet or exceed the criteria mentioned

above, permit certificates of construction and operation are required by the Tennessee Dam Safety Office in the Division of Water Supply of the Tennessee Department of Environment and Conservation. Further information on safe dam design standards, regulations, and permit applications are available at the website:

<http://www.state.tn.us/environment/permits/safedam.htm>.

Three sediment basin modifications can be included in the sediment basin design to increase the settling efficiency for basins:

**Surface skimmers.** Surface skimmers should be utilized as the dewatering device whenever practical. A skimmer dewateres from the water surface rather than from below the surface.

**Baffles.** Both porous and non-porous baffles are often used to prevent decrease turbulent flow in a basin settling zone such as the forebay, thereby increasing the settling rate for sediment.

**Chemical flocculents.** Flocculents such as polyacrylamides (PAM) can be used to enhance the settling efficiency of fine particles such as colloidal clays. This type of treatment should be introduced as part of the sediment treatment train, *upstream* from sediment basins, if conventional settling basin treatment is not, or is unlikely not, effective. In any case, contingency plans for using flocculents, such as PAM, should be built into SWPPPs in case conventional treatment fails and TDEC deems its use necessary.

**Design Criteria** Note that the following design procedure is founded on the premise that the engineer or landscape architect has a fundamental understanding of hydrology and hydraulics, as well as an understanding of the necessity of all standard components of the sediment basin. Therefore, all sediment basins shall have a permanent pool. The purpose of having a permanent pool of water is to allow sediment particles to settle out and remain in the pond while skimming off or dewatering the upper layer of relatively clear water near the pond surface. Under no circumstances should an opening be placed at the bottom of a sediment pond. A bottom opening in a principal spillway riser pipe would eliminate a permanent pool by forcing the pond to empty after each storm, along with most of the fine sediment particles concentrated near the bottom of the pond. A riser with a bottom opening, surrounded by porous rock, silt fence fabric, or straw bales, is not effective practice for removing fine sediment particles.

#### STEP 1: DETERMINE THE BEST LOCATION

**Runoff from off-site undisturbed areas should be diverted away from or around the disturbed areas and the basin.** To improve the effectiveness of the basin, it should be located so as to intercept the largest possible amount of runoff from the disturbed area, while undisturbed areas are routed around the treatment area. The best locations are generally low areas and natural swales or drainageways below disturbed areas. It is recommended that the basin be located at least 50 feet outside the designated floodway or 60 feet from the top of bank of small streams, or as otherwise required by local ordinance, whichever is greater. Basin efficiency can be improved by the use of baffles and by introducing chemical flocculants.



The basin should not be located where its failure would result in the loss of life or interruption of the use or service to public utilities or roads.

**Maximum Drainage Area:** The maximum allowable total drainage area (disturbed and undisturbed) feeding into a temporary sediment basin is 50 acres. The 50 acre maximum drainage area limitation is derived from the CGP; additional engineering controls and/or treatment may be necessary for management of stormwater runoff originating from drainage areas exceeding 50 acres, covered under individual NPDES permit(s). However, basins cannot be installed in streams. It is recommended that when the drainage area to any one temporary basin exceeds 25 acres, an alternative design procedure that more accurately defines the specific hydrology, sediment loading, hydraulics of the site, and the control measures in use be utilized to perform design calculations. The design criteria in this manual do not generate hydrographs, estimate sediment erosion and delivery rates, provide hydraulic routing, or predict sediment capture efficiency. More rigorous and accurate design considerations, which are more site-specific than those in this manual, are acceptable and encouraged with any size basin.

**Access to maintain the basin must be provided during basin construction and operation.** Maintenance access road(s) shall be provided to the sediment basin facility for inspection and for access by maintenance and emergency vehicles. An access road around the basin is recommended for convenient removal of sediment from the basin or basin cells with appropriate equipment. An access ramp into the basin itself is discouraged because of the potential for creating equipment-generated rutting and stabilization problems.

## STEP 2. SET THE BASIN GEOMETRY

**Basin Shape:** It is important that the designer of a sediment basin incorporate features to maximize detention time within the basin in order to improve its trapping efficiency. The primary means for accomplishing this will be specifying a length to width ratio of at least 4L: 1W. Other suggested methods of accomplishing this objective are:

- A wedge shape with the inlet located at the narrow end - ideally, the shape would be symmetrical about the pond's central axis formed by the inlet – riser – center of the dam.
- Installation of baffles or diversions in situations where a 4L: 1W ratio is otherwise not practical (See Figure 7.31-1 for more information).

### *4L:1W Ratio*

The purpose of having a length to width ratio of at least 4L:1W is to minimize the "short-circuiting" effect of the sediment-laden inflow to the riser and increasing the flow length through the treatment zone. Having a symmetrical basin about the central axis from the inlet to the riser tends to reduce dead or ineffective space.

The length of the flow path (L) is the distance from the point of inflow to the riser outflow point. The point of inflow is the point that the stormwater runoff enters the active (sometimes called "normal") pool, created by the elevation of the riser crest. The pool area (A) is the area of the active pool. The effective width (We) is

equal to the area (A) divided by the length (L). The length to width ratio (L:W) is determined from the equation:

$$L:W = L/W_e = L/(A/L) = L^2/A$$

The designer is encouraged to locate all inflows at or near the point of the wedge. However, where there is more than one inflow point and where circumstances preclude this ideal arrangement, any inflow point which conveys more than 30 percent of the total peak inflow rate shall meet the above length-width ratio criteria. If the 4:1 ratio pond cannot be attained on the site, an equivalent 4:1 flow path must be provided through the use of non-porous baffles. Specifications for the stabilization of the basin side slopes and possibly reinforcement through the use of erosion control matting must be included in the design. Otherwise, the inflow point could potentially become the point of greatest concentrated erosion within the basin's watershed.

#### *Non-porous Baffles*

The required basin shape should be obtained by proper site selection and by excavation to reduce dead storage and to maximize sediment removal efficiency. Where less than ideal conditions exist, a non-porous baffle may be constructed in the basin. The purpose of the non-porous baffle is to increase the effective flow length from the inflow point(s) to the riser. Non-porous baffles shall be placed mid-way between the inflow point and the riser. The non-porous baffle length shall be as required to achieve the minimum 4L:1W length-width ratio at less than ideal site conditions. The effective length ( $L_e$ ) shall be the shortest distance the water must flow from the inflow point around the end of the non-porous baffle to the outflow point.

Then:

$$L:W = L_e/W_e = L_e^2/A$$

Three baffle situations where non-porous baffles should be used are shown in Figure 7.31-1. Note that for cases A and B:

$$L_e = L_1 + L_2$$

Where  $L_1$  and  $L_2$  are the shortest travel path segments around the non-porous baffles. For case C,  $L_e = 2(L_1 + L_2)$

Non-porous baffle material shall be outdoor grade and weather resistant. Non-porous baffles should be placed in such a manner as to minimize interference with basin cleaning. Construction should be modular for easy maintenance and convenient replacement in the event of damage from cleaning or from deterioration. Non-porous baffles should be inspected frequently for tears or breaks from weathering, high flows, and from cleaning damage. Damaged materials shall be replaced or repaired immediately.

The dimensions necessary to obtain the required basin volume and surface area shall be clearly shown on the plans to facilitate plan review and inspection.

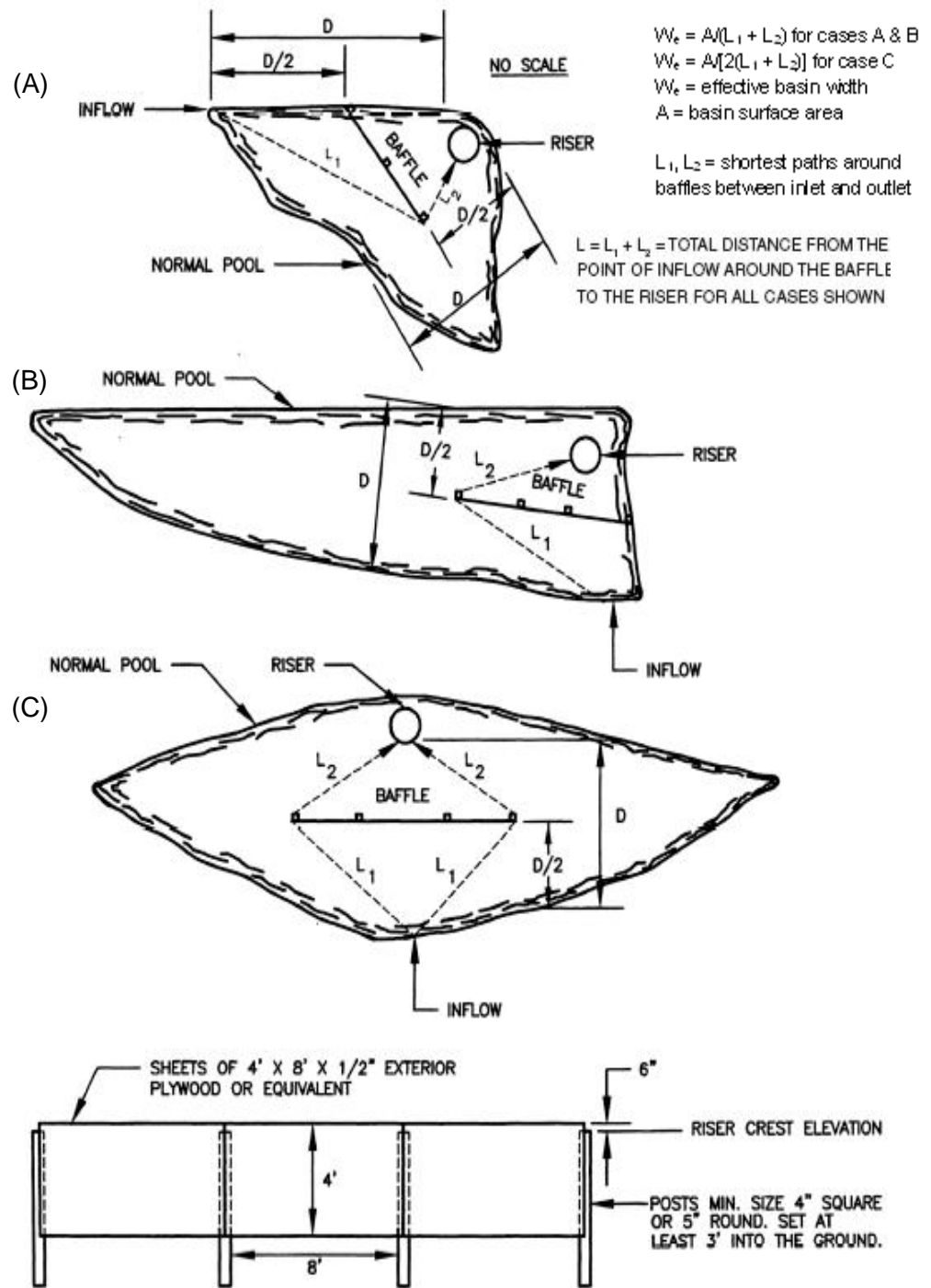

Figure 7.31-1 Non-porous Baffle Locations in Sediment Basins – To Increase Flow Length (Source: NRCS)

**Volume:** The sediment basin treatment area is designed based upon two major components, wet and dry storage:

Total volume = 134 yd<sup>3</sup>/acre (3618 ft<sup>3</sup>/acre) of drainage. This total volume is allocated into two major storage components. Half of this volume (67 yd<sup>3</sup>/acre or 1809 ft<sup>3</sup>/acre) must be provided as *wet* storage, which establishes the permanent pool and the sediment capture zone. The volume below permanent pool shall be measured from the lowest point of the basin up to the bottom elevation of the dewatering device. The other half, or *dry* storage, also should have a minimum volume of 67 yd<sup>3</sup>/acre (1809 ft<sup>3</sup>/acre), including both the sediment removal zone and the forebay volume (described below). The top of the dry storage defines the principal spillway riser crest and establishes a minimum volume for treatment in the sediment basin. The dry storage volume is to be dewatered down to the permanent pool in 72 hours.

The above total volume requirements, representing one inch of erosion and sediment yield over one acre, are regarded as **minimum** criteria. Where construction sites have steep slopes and/or soils capable of producing greater sediment yields, design professionals should consider using an alternative physically-based approach, such as RUSLE, to size the total storage volume and to protect critical aquatic resources and safety/health of the public. It is noted that disturbed and unprotected areas can contribute large amounts of runoff containing a significant amount of fine-grained sediment particles that are difficult to remove and can reduce the overall performance of a sediment basin. The following conditions and circumstances need to be considered in determining whether or not the basin volume would need to be increased:

- Highly erodible soils
- Steep upslope topography
- Space-limiting basin geometry (depth and/or shape)
- Degree to which off- and/or on-site runoff is diverted from contributing undisturbed areas
- Sediment cleanout schedule
- Degree to which chemical flocculent agents are added to inflowing runoff
- Extent to which other erosion and sediment control practices are used
- Critical downstream conditions

**Surface area:** Pond surface area is very important to overall sediment basin efficiency. Research shows that sediment trapping efficiency depends primarily on the sediment particle size and the ratio of basin surface area to inflow rate. Basins with a large surface area to volume ratio are most effective in trapping sediment. Generally, the smaller the sediment particle size, the slower the settling velocity, and the larger the required basin surface area. Additionally, the larger the storm water flow into the basin, the larger the required basin surface area. The minimum required surface area, measured at the top of the dry storage pool zone, establishes the crest of the principal spillway, and is calculated by the following empirical formula (Barfield and Clar, 1986):

$$A_s = 0.01Q_p$$

Where

$A_s$  = Surface area (acres)

$Q_p$  = Peak inflow (cfs) for the design storm (2- or 5-year, 24-hour as appropriate)

The method above provides about 75% trapping efficiency for silt loams and higher efficiencies for coarser particles. Additional treatment may be necessary to trap small silt and clay particles.

The permanent pool protects against re-suspension of sediment, promotes better settling conditions between runoff events, and provides a zone for sediment storage. Therefore an opening at the bottom of the riser is not acceptable because it allows the pond to completely drain between storms and prevents the establishment of a permanent pool and sediment capture zone. A minimum depth of 3 feet shall be designed for the permanent pool.

The dry storage is to be dewatered over a period of 72 hours as discussed in the section on Dewatering. The forebay compartment of the dry storage area must have at least 2 porous baffles to promote more effective settling (see Section 7.33 Baffles).

*Elevations:* The lower elevation limit of the dewatering device should be installed to dewater the dry storage in 72 hours. The volume of the active or drawdown zone shall be measured from the crest elevation of the principal (service) spillway riser pipe down to the permanent pool level.

**Forebay:** A forebay is required at the primary inlet of the sediment basin to intercept the initial flow and provide an opportunity for larger sand and silt particles to settle out before entering the primary basin. The forebay volume shall be at least 25% of the dry sediment storage volume; this 25% forebay volume can be credited toward the primary basin's required dry storage volume. The bottom elevation of the forebay should equal the top of the permanent pool elevation of the primary basin, and the forebay should be separated from the primary basin with a porous barrier such as a rock berm to promote larger particle settling and spread the incoming flow out to help prevent short-circuiting of the primary basin. The berm overflow crest shall be set no higher than the top of the principal spillway riser crest. To minimize resuspension of trapped sediment and scour in the forebay during high flows, the energy of the influent flow must be controlled as it enters and flows through the forebay. This can be in the form of a plunge pool, rip-rap, or other energy-dissipating control measures. The rock berm shall be designed to pass the 2 or 5-year, 24-hour storm peak flow, as appropriate, without eroding the berm abutments.

The forebay must be readily accessible for maintenance as it will fill up with sediment more quickly than the primary basin. Porous baffles are recommended within the forebay as well to enhance the sediment capture efficiency. Refer to Figures 7.31-2A, -2B and 7.31-3 below for more information. More details can be found in the standard drawing.

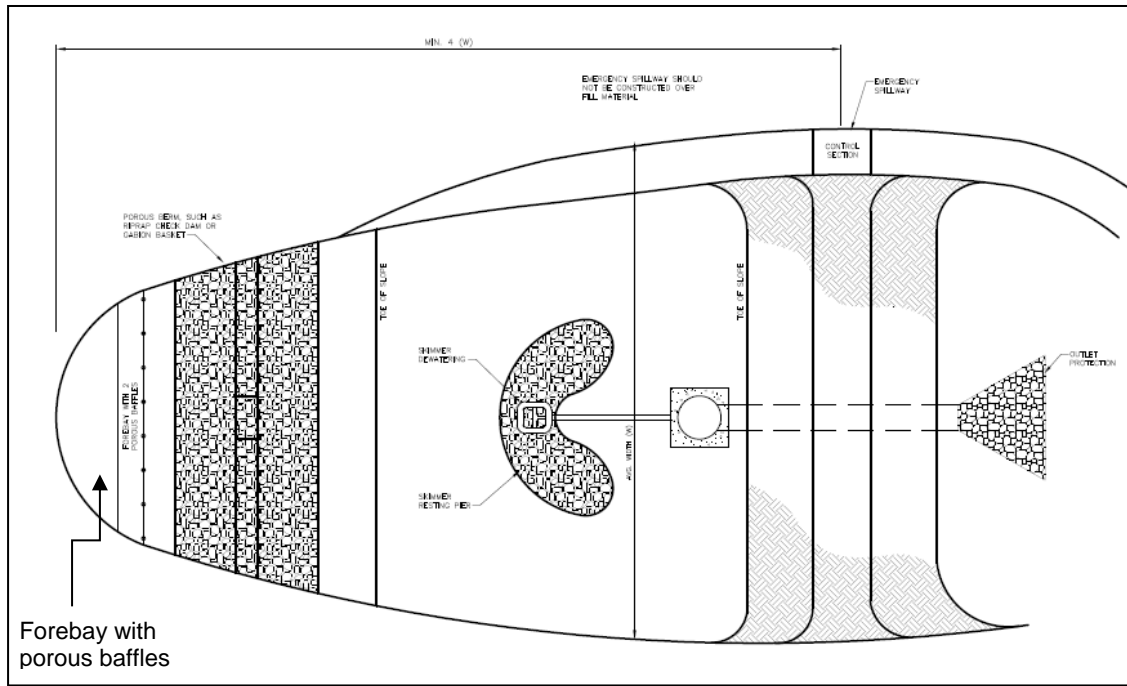

Figure 7.31-2A Sediment Basin with Forebay, Plan View

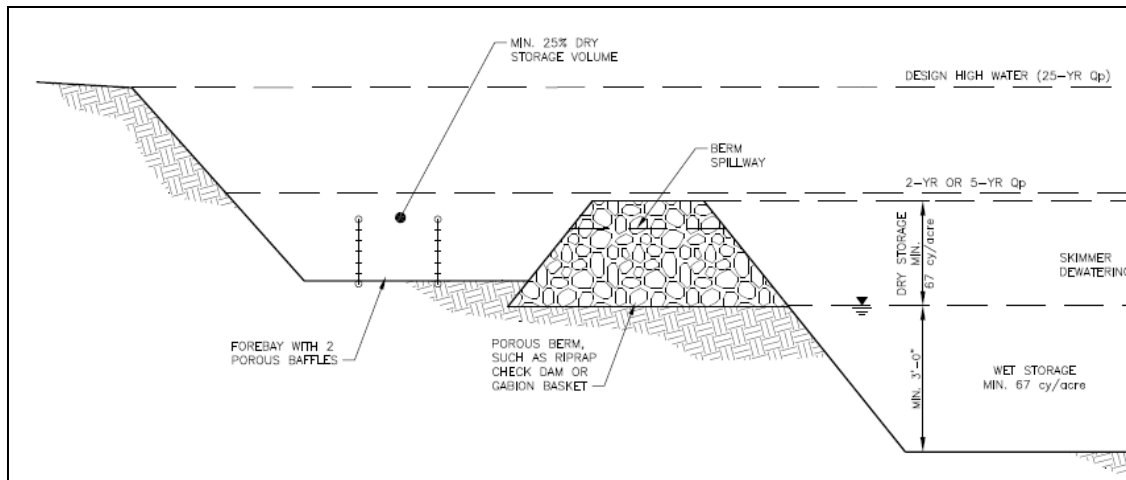

Figure 7.31-2B Cross Sectional View of Forebay, Showing Elevations





**Figure 7.31-2C Forebay with Porous Berm (Gabion Rock)**

**STEP 3: DESIGN THE PRINCIPAL SPILLWAY AND DEWATERING DEVICE.**

Design the principal spillway for the 2-yr, 24-hr (or 5-yr, 24hr) storm. Incoming flow and storage calculations must begin at the elevation of the permanent pool. Flow through the dewatering device cannot be credited when calculating the 25yr. 24 hr storm outflow from the basin.

The outlets for the basin should consist of a combination of principal and emergency spillways. These outlets must pass the peak runoff expected from the contributing drainage area for a 25-year, 24- hour storm. If, due to site conditions and basin geometry, a separate emergency spillway is not feasible, the principal spillway must pass the entire peak runoff expected from the 25-year 24-hour storm. However, an attempt to provide a separate emergency spillway should always be made (refer to "Emergency Spillway" later on in this section) because the principal spillway riser is vulnerable to clogging by debris during high runoff events. Runoff computations shall be based upon the soil cover conditions that are expected to prevail during the life of the basin. In determining total outflow capacity, the flow through the dewatering device cannot be credited when calculating the 25- year 24-hour storm elevation because of its potential to become clogged. However, the capacity of the principal spillway (i.e. the flow expected through the top of the riser) can be credited to the emergency spillway when determining the peak flow and maximum pond elevation resulting from the 25-year, 24-hour storm. In other words, routing calculations can assume both the principal spillway and emergency spillway are actively flowing for determining the maximum depth of the 25-year, 24-hour storm. Incoming flood flow and storage calculations must begin at the elevation of the permanent pool.

Note that temporary sediment basin storage and outflow controls are not normally designed to reduce incoming peak flows. Consequently, the spillways designed by the procedures contained in the standard and specification will not necessarily

result in any major reduction in the peak rate of runoff. If a reduction in peak runoff is desired or required by local regulations during the construction period, the appropriate hydrographs/storm routings should be generated to adjust the basin and outlet sizes.

**Principal Spillway:** The principal spillway typically consists of a vertical riser pipe or box of corrugated metal or reinforced concrete. The riser should have a minimum diameter of 18 inches, and be joined by a watertight connection to a horizontal drain pipe (barrel) extending through the embankment and discharging beyond the downstream toe of the fill. The riser and all pipe connections shall be mechanically sound and completely water tight except for the inlet opening at the top or dewatering openings, and shall not have any other holes, leaks, rips, or perforations. If the principal spillway is used in conjunction with a separate emergency spillway, the principal spillway must be designed to pass at least the peak flow expected from of 2-year (5-year), 24-hour storm. If no emergency spillway is used, a combined principal/emergency spillway must be designed to pass the entire peak flow expected from a 25-year 24-hour storm. See Figure 7.31-3 for details.

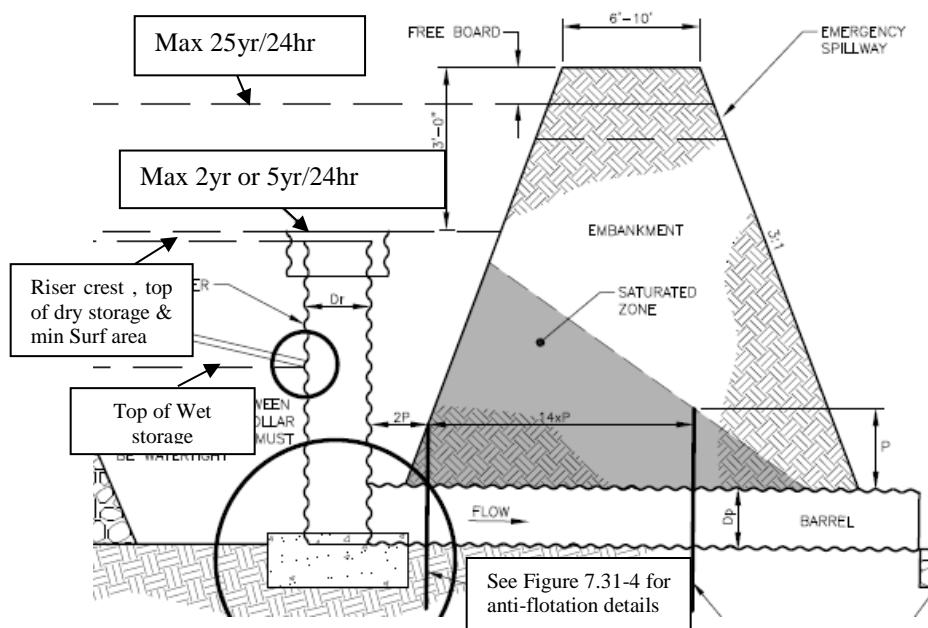

Figure 7.31-3 Elevations within the Basin

*Spillway Foundation:*

The foundation base of the principal spillway must be firmly anchored to prevent floating due to buoyancy. Computations must be made to determine the anchoring requirements to prevent flotation. A minimum factor of safety of 1.25 shall be used (downward forces = 1.25 x upward forces). For risers 10 feet or less in height, the anchoring may be done in one of the two following ways:

1. A concrete base 18 inches thick and twice the width of riser diameter shall be used and the riser embedded at least 6 inches into the concrete.

See Figure 7.31-4 for details.

2. A square steel plate, a minimum of 1/4-inch thick and having a width equal to twice the diameter of the riser shall be welded to the riser pipe. It shall be covered with 2.5 feet of stone, gravel, or compacted soil to prevent flotation. See Figure 7.31-4 for details. If compacted soil is selected, compaction of 95% of maximum proctor density is required over the plate. Also, added precautions should be taken to ensure that material over the plate is not removed accidentally during removal of sediment from basin. One method would be to use simple marker posts at the four corners.

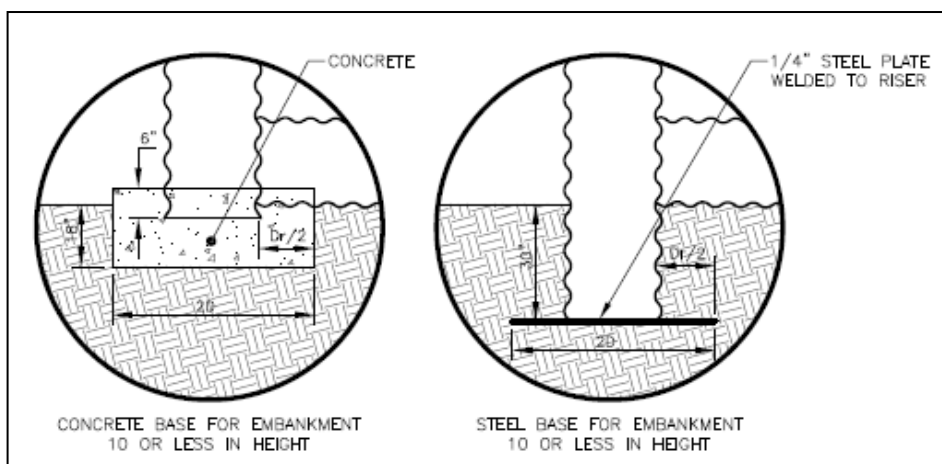

**Figure 7.31-4 Anti-Flotation Device**

*Design Elevations:*

The crest of the principal spillway riser shall be set either at the required surface area elevation or at the elevation corresponding to the total wet and dry storage volume required, whichever is greater (See the Basin Geometry for details).

If the principal spillway is used in conjunction with an emergency spillway, the riser elevation shall be a minimum of 1.0 foot below the crest of the emergency spillway. In addition, a minimum freeboard of 1.0 foot shall be provided between the maximum 25-year pool level and the top of the embankment. If no separate emergency spillway is used, the crest of the combined principal/emergency spillway shall be a minimum of 3 feet below the top of the embankment with a minimum freeboard of 2.0 feet between the 25-year pool level and the top of the embankment. Refer to Figures 7.31-3 and 7.31-12 for freeboard details.

*Anti-Vortex Device and Trash Rack:*

An anti-vortex device and trash rack shall be attached to the top of the principal spillway to improve the flow characteristics of water into the spillway and to reduce the possibility of floating debris from blocking the principal spillway. The anti-vortex device shall be of the concentric type similar to that shown in Figure 7.31-5 and 7.31-6, and designed using the information provided in Table 7.31-1.

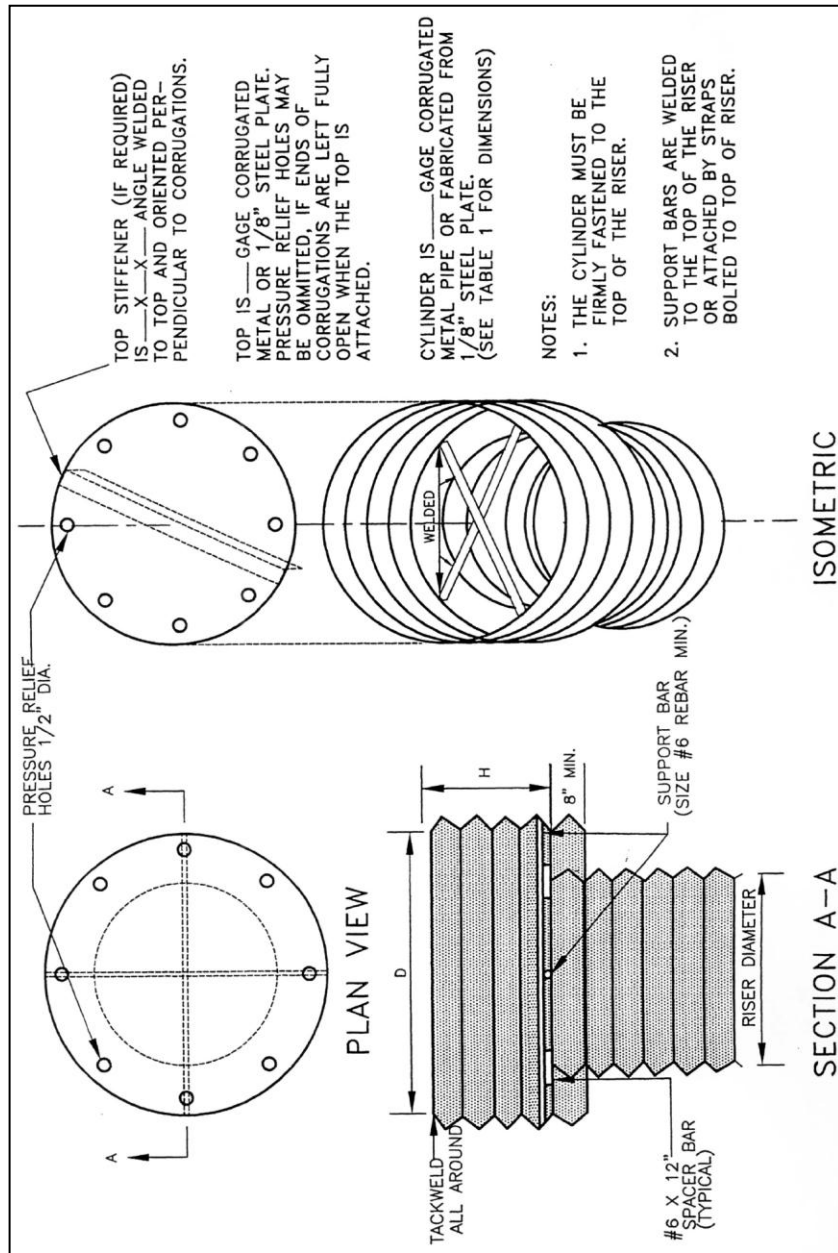

Figure 7.31-5 Anti-Vortex Device Design (Source: US-NRCS)

Riser Diam., inches	Cylinder			Minimum Size Support Bar	Minimum Top	
	Diameter, inches	Thickness, gage	Height, inches		Thickness	Stiffener
12	18	16	6	#6 Rebar or 1 1/2" x 1 1/2" x 3/16" angle	16 ga. (F&C)	-
15	21	16	7	" "	" "	-
18	27	16	8	" "	" "	-
21	30	16	11	" "	16 ga.(C), 14 ga.(F)	-
24	36	16	13	" "	" "	-
27	42	16	15	" "	" "	-
36	54	14	17	#8 Rebar	14 ga.(C), 12 ga.(F)	-
42	60	14	19	" "	" "	-
48	72	14	21	1 1/4" pipe or 1 1/4" x 1 1/4" x 1/4" angle	14 ga.(C), 10 ga.(F)	-
54	78	14	25	" "	" "	-
60	90	14	29	1 1/2" pipe or 1 1/2" x 1 1/2" x 1/4" angle	12 ga.(C), 8 ga.(F)	-
66	96	14	33	2" pipe or 2" x 2" x 3/16" angle	12 ga.(C), 8 ga.(F) w/stiffener	2" x 2 1/4" angle
72	102	14	36	" "	" "	2 1/2" x 2 1/2" x 1/4" angle
78	114	14	39	2 1/2" pipe or 2" x 2" x 1/4" angle	" "	" "
84	120	12	42	2 1/2" pipe or 2 1/2" x 2 1/2" x 1/4" angle	" "	2 1/2" x 2 1/2" x 5/16" angle

Note: The table above is useful only for corrugated metal pipe. Concrete trash rack and anti-vortex devices are also available. Manufacturer's recommendations should be followed for concrete applications.

Note: Corrugation for 12"-36" pipe measures 2 2/3" x 1/2"; for 42"-84" the corrugation measures 5" x 1" or 8" x 1".

Note: C = corrugated; F = flat.



**Figure 7.31-6 Dewatering device  
on Riser with Trash Rack**



**Outlet Barrel:** The drainpipe barrel of the principal spillway, which extends through the embankment, shall be designed to carry the flow provided by the riser of the principal spillway with the water level at the crest of the emergency spillway. The minimum size of the pipe shall be 12 inches in diameter to minimize clogging. The riser and all pipe connections shall be mechanically sound and completely watertight and not have any other holes, leaks, gashes, or perforations other than designed openings. Do not use dimple (mechanical) connectors for CM pipe under any circumstances. The connection between the riser and the barrel must be watertight to prevent local scouring. The use of plastic pipe through the dam should be done with caution because of potential deflection, creep and separation from surrounding embankment soil. The outlet of the barrel must be protected to prevent erosion or scour of downstream areas. Measures may include excavated plunge pools, riprap, impact basins, revetments, or other effective methods. Refer to Section 7.23 Outlet Protection. Where discharge occurs at or near the property line, drainage easements should be obtained in accordance with local ordinances. Caution should be given in directing all outlet water from the impoundment to a receiving watercourse so that natural flow paths are preserved above off-site property owners.

*Anti-Seep Collars:* Anti-seep collars are used to reduce uncontrolled seepage and prevent internal erosion or "piping" inside the dam along the drainpipe barrel. Anti-seep collars shall be used on the drainpipe barrel of the principal spillway within the normal saturation zone of the embankment to increase the seepage length by at least 10%, if either of the following two conditions is met:

1. The settled height of the embankment exceeds 10 feet.
2. The embankment has a low silt-clay content (Unified Soil Classes SM or GM) and the barrel is greater than 10 inches in diameter.

The anti-seep collars shall be installed within the saturated zone. The assumed normal saturation zone shall be determined by projecting a line at a slope of 4 horizontal: 1 vertical from the point where the normal water elevation (can be assumed to be the top of the principal spillway) meets the upstream slope to a point where this line intersects the invert of the barrel pipe or bottom of the cradle, whichever is lower. The collars shall extend a minimum of 2 feet around the barrel. The maximum spacing between collars shall be 14 times the projection of the collars above the barrel. Collars shall not be closer than 2 feet to a pipe joint. Collars should be placed sufficiently far apart to allow space for hauling and compacting equipment. Precautions should be taken to ensure that 95% compaction is achieved around the collars. Connections between the collars and the barrel shall be watertight. Plans should specify method of compaction around the pipe barrel to ensure adequacy and to prevent damage to the antiseep collars and joints. See Construction Details (Principal Spillway) and refer to Figure 7.31-7 for details. Drainage filter diaphragms may be substituted for anti-seep collars, per NRCS (2003) design practice guidelines.



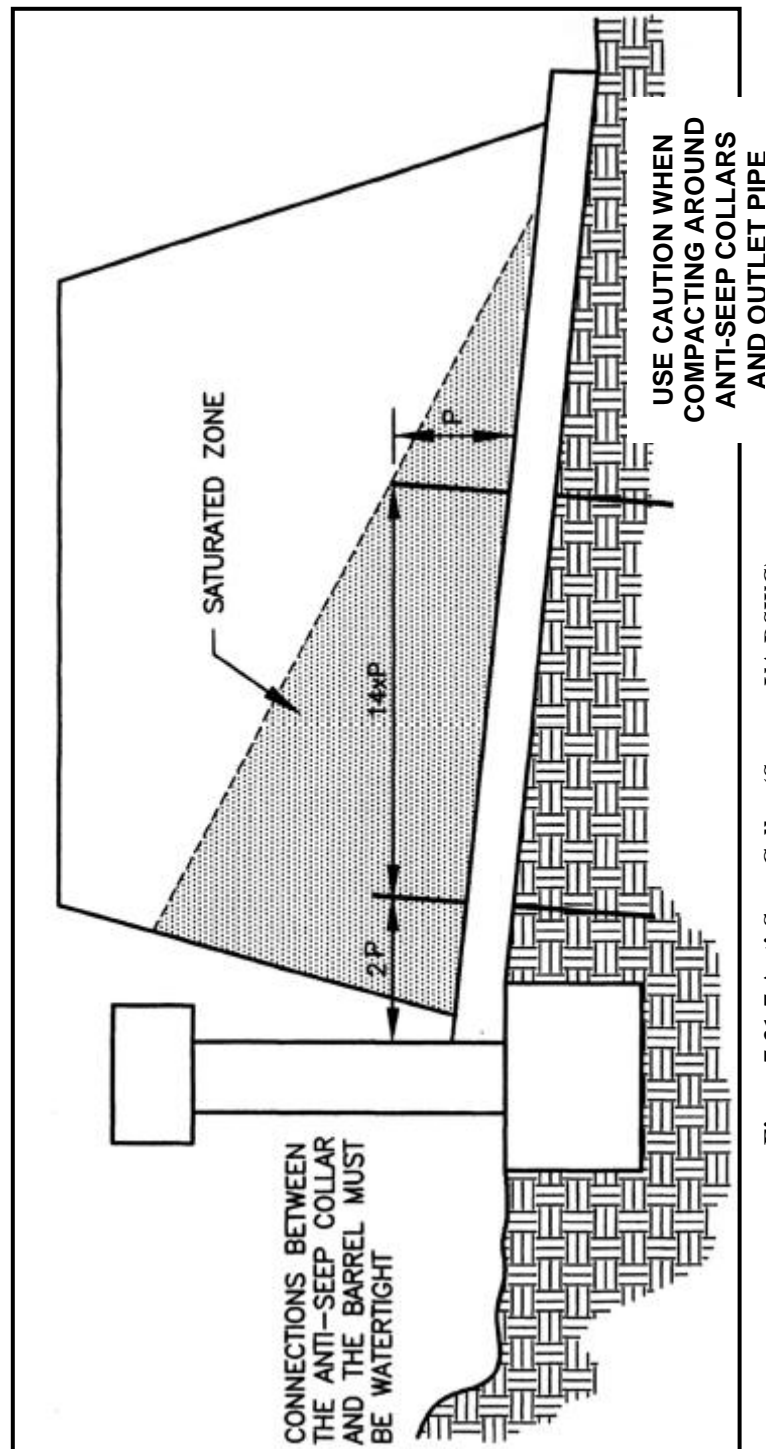

Figure 7.31-7 Anti-Seep Collar (Source: VA DSWC)

**Dewatering:** Provisions shall be made to dewater the basin down to the permanent (wet) pool elevation. Particle characteristics, flow-through velocity, surface loading rate, turbulence levels, sediment concentration and other lesser factors can have a significant effect on the sediment trapping efficiency in a basin. The dry storage zone above the permanent pool should draw down in 72 hours to promote settling. Drawdown or dewatering must occur from the ponded water surface. Two

types of devices are acceptable for dewatering the dry storage zone of a sediment basin. The floating surface skimmer is the preferred dewatering method, as it dewateres from the top of the water column.

### 1. Perforated vertical pipe or tubing

An economical and efficient device for performing the drawdown is a section of perforated vertical pipe or tubing, which is connected to and braced to the principal spillway at two locations. The perforations in the pipe allow the upper 2 to 3 foot zone of pond water containing the lowest sediment concentration to be drawn off. The number, diameter and location of drawdown holes should be designed, specified and constructed to drain the dry storage volume in the 72-hour period. A slide gate type of valve is required at the bottom of this tubing for achieving the desired drawdown time and seasonal control. Figure 7.31-8 provides a schematic orientation of such a device. A dewatering operation procedure might be to keep the slide gate valve closed during dry periods, or close it before anticipated precipitation events. Then, during and after the precipitation event, the slide gate valve is manually adjusted to allow the draw down to begin. The amount of adjustment should be determined so that the draw down to the wet pool elevation occurs over a period of 72 hours, as stated above.

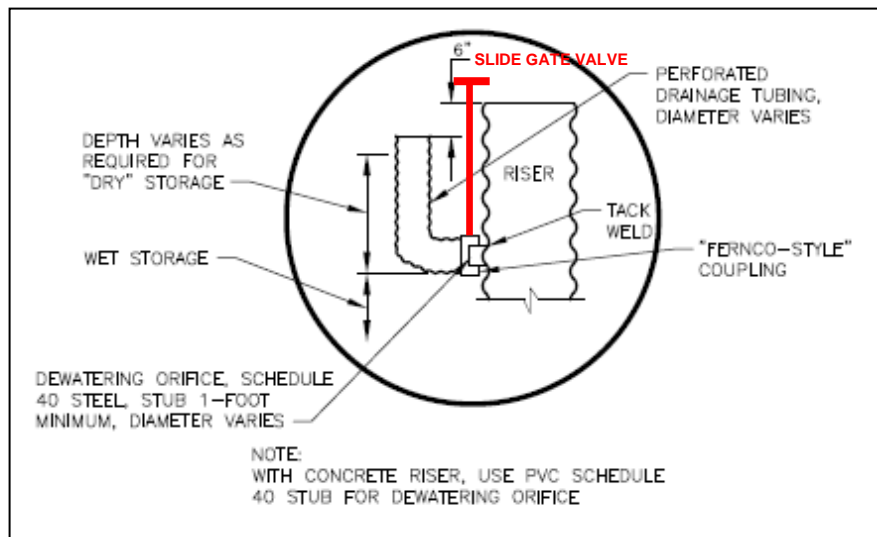

**Figure 7.31-8 Slotted Drain Pipe Dewatering Device**

### 2. Floating surface skimmer

Selection of floating skimmer and orifice sizes should be based on the volume of "dry" water storage to be drained over the dewatering time of 72 hours and designed according to skimmer manufacturer design specifications, charts and tables, calculators and procedures. The surface skimmer design and selection involves two steps:

1. Selecting appropriate overall skimmer size having a capacity for dewatering a specified volume ( $V$ ) of "dry" storage water over a time period ( $t$ ) of 72 hours (3 days).
2. Determining the skimmer's inlet orifice diameter sized for a flow based on  $Q = V/t$  and using either the manufacturer's orifice sizing tables or the

orifice equation with the recommended head (H) and coefficient (C) for a particular skimmer:  $Q = CA_o \sqrt{2gH}$

Unlike stationary perforated pipe dewatering devices where the flow rate decreases as the dry pool zone dewateres, the flow rate will be constant for a surface skimmer since the head over the floating skimmer inlet orifice remains constant over the dewatering period.

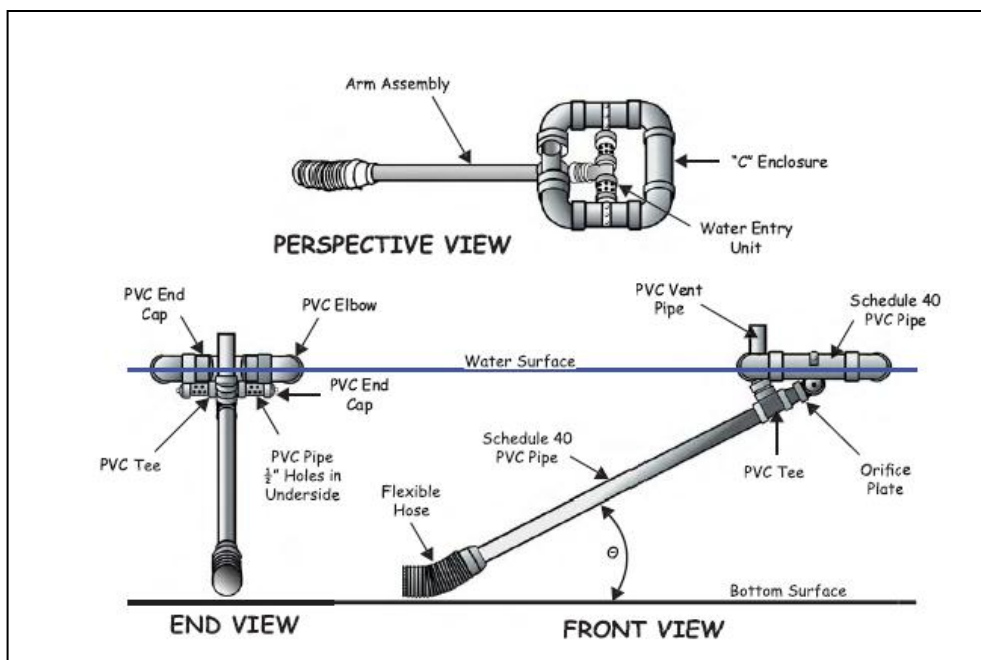

**Figure 7.31-9 Schematic of a floating skimmer dewatering device**

Include a pier constructed of concrete block or stone for the skimmer to rest upon to limit the dewatering depth and to prevent the skimmer from getting stuck in the muddy bottom. The top of the pier should be set at the elevation of the permanent wet pool. Figure 7.31-9 and Figures 7.31A and 7.31-10B below illustrate the construction and installation of a skimmer dewatering device and resting pier.

Because of the low flow capacity of the dewatering device or orifice and its potential for becoming clogged, no credit should be given for drawdown by the device in the calculation of the principal or emergency spillway locations.

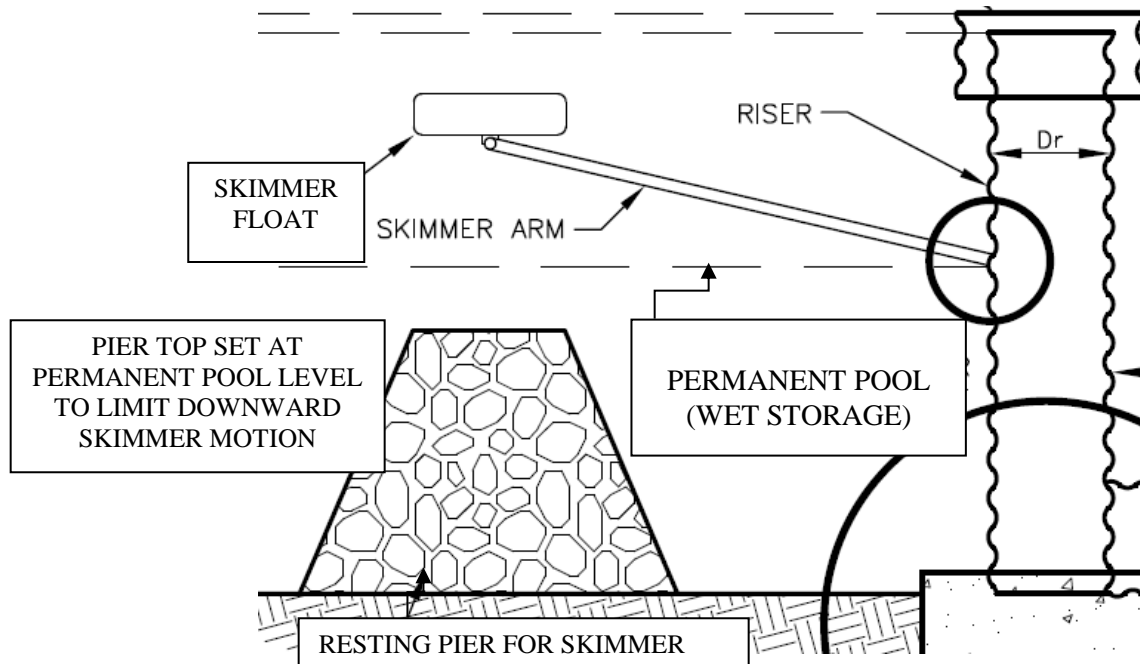

Figure 7.31-10A Skimmer Pier and Permanent Pool

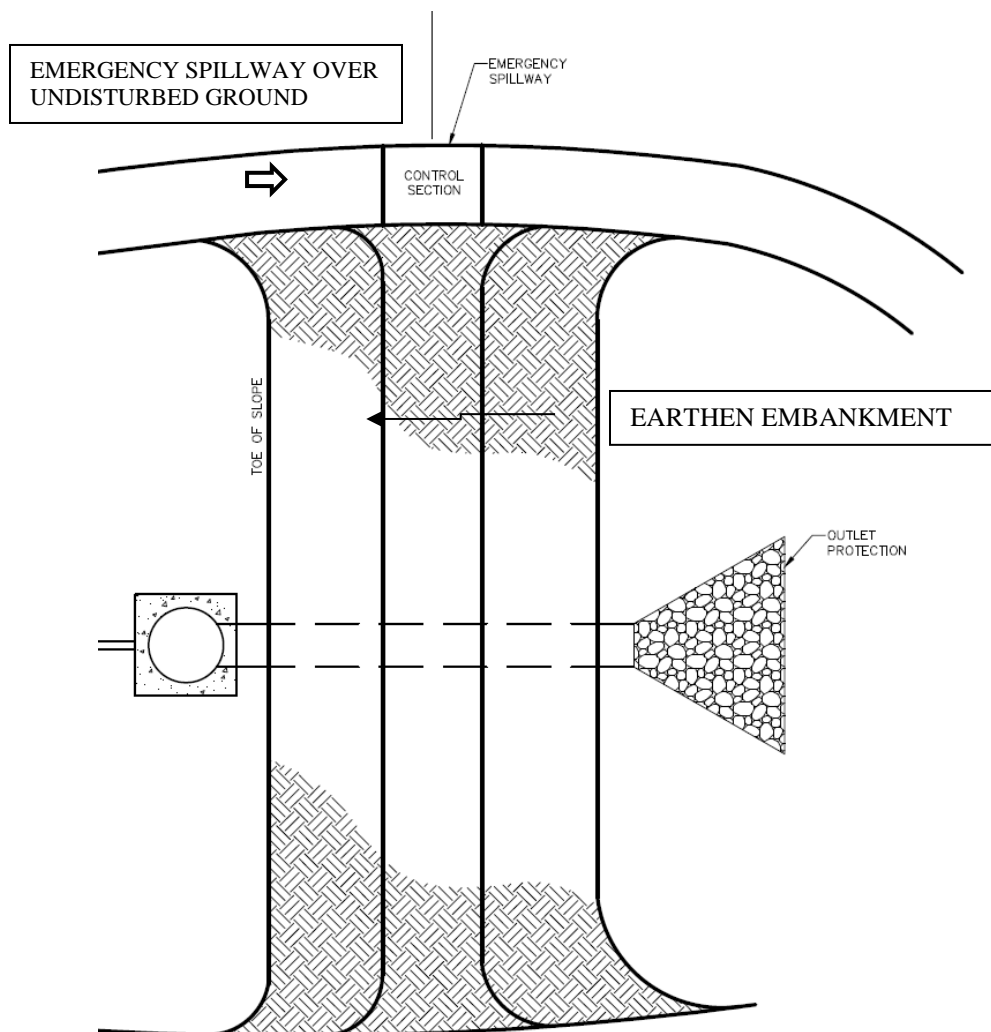

Figure 7.31-10B Floating Skimmer Installation

**STEP 4: SET THE EMERGENCY SPILLWAY AND TOP OF EMBANKMENT ELEVATIONS.**

**Emergency Spillway:** The emergency spillway acts as a safety release for a sediment basin, or any impoundment structure, by conveying the larger, less frequent storms (minimum 25-year, 24-hour storm) through the basin without overtopping or damaging the embankment. The emergency spillway also acts as its name implies - an emergency outlet - in case emergency circumstances arise from excessive sedimentation or damage to the riser, which prevents flow through the

principal spillway. The emergency spillway shall consist of an open channel constructed adjacent to the embankment. The emergency spillway should be installed over undisturbed ground or consolidated soil, rather than over an unconsolidated embankment fill of the dam, whenever possible, to prevent damage to the dam. An emergency spillway constructed over a section of the embankment fill is susceptible to settlement, reduced freeboard, and dangerous scouring during the spillway design storm. The emergency spillway shall be lined with a non-erodible material based upon the designed shear stress in the channel (see Channel Design Section 7.27). Design of an emergency spillway requires the special expertise of a qualified, engineering design professional. The control section is a level portion of the spillway channel at the highest elevation in the channel. See Figure 7.31-9 for location of emergency spillway and Figure 7.31-11 for an example of an excavated earthen spillway.



**Figure 7.31-11 Earthen Embankment**

An evaluation of site and downstream conditions must be made to determine the feasibility and justification for the incorporation of an emergency spillway. In

some cases, the site topography does not allow a spillway to be constructed in undisturbed material, and the temporary nature of the facility may not warrant the cost of disturbing more acreage to construct and armor a spillway. The principal spillway must then be sized as a combined spillway to convey all the design storms, through the 25-year storm at a minimum.

The outlet channel to which the emergency spillway discharges where the flow transitions from the spillway to a channel must be designed to prevent erosion based upon shear stress.

*Capacity:* The emergency spillway shall be designed such that the 25-year 24-hour storm event is routed through the pond and discharge channel and allows for a minimum freeboard of 1.0 foot above the 25-year, 24-hour peak flow depth.

*Design Elevations:* The maximum 25-year storm pool elevation shall have a freeboard of at least 1.0 foot below the top of the embankment as shown in Figure 7.31-12.

**Embankment Elevation:** The height of the embankment dam is measured from its crest down to the lowest point of natural grade (at the downstream toe of the embankment). Embankment geometries are provided in the table below.

**Table 7.31-2 Embankment geometries**

<b>Embankment Height, ft.</b>	<b>Top width</b>	<b>Upstream Side Slopes</b>	<b>Downstream Side slopes</b>
<10	6 ft min.	2:1 or flatter	3:1 or flatter
10-14	8 ft. min.	2.5:1 or flatter	3:1 or flatter
15-19 ft	10 ft. min.	2.5:1 or flatter	3:1 or flatter

The site foundation for the embankment should be prepared by removing all vegetation, debris, topsoil, and large rocks down to competent material. Embankments should be keyed into the foundation soil. The embankment height should include a 10 percent settlement allowance across the longitudinal axis of the dam to ensure required freeboard. The minimum 1-foot freeboard required between the maximum 25-year design flow level and top of the dam is shown in Figure 7.31-12.



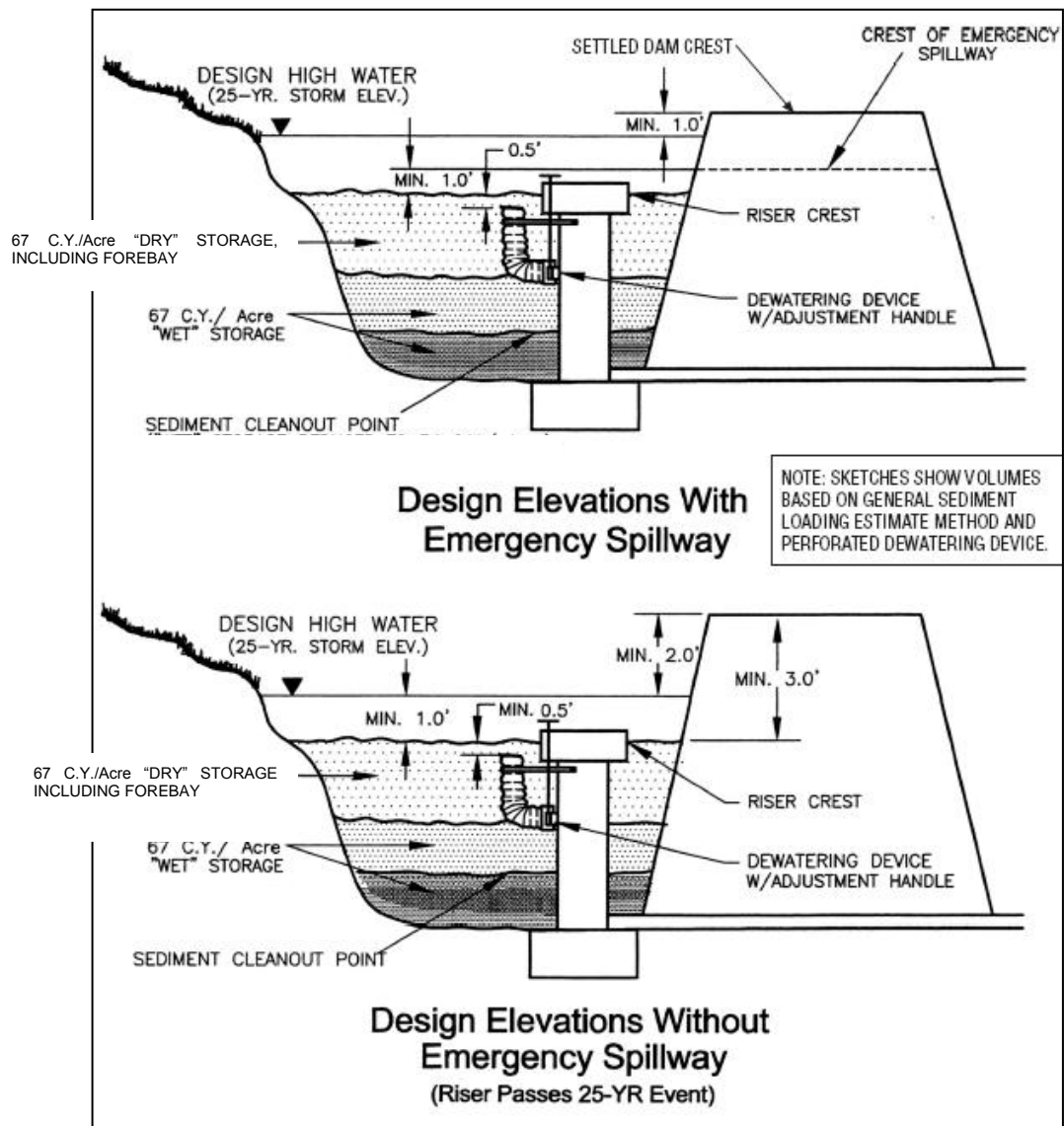

Figure 7.31-12 Schematic Drawing of Typical Sediment Basin (Source: VA DSWC)

#### Multiple Uses:

Sediment basins may remain in place after final site stabilization is completed to serve as permanent stormwater management structures. They also may be used *during* construction for stormwater management. Because the most practical location for a sediment basin is often the most practical location for a stormwater management basin, it is often desirable to utilize these structures for permanent stormwater management purposes. It should be noted, however, that in most cases, a typical structure's outlet control system would vary from construction to post construction periods. Care must be taken to avoid constructing an outlet control system, which will achieve the desired permanent stormwater management treatment but will not provide the necessary facility for the containment and settling of sediment-laden construction runoff. For example, a permanent stormwater detention structure may have a bottom control orifice in the riser, while a temporary sediment pond does not. Notably, the design for such

permanent flow control ponds is beyond the scope of these standards and specifications.

**Equivalent Measures:** For locations which serve 10 or more acres of disturbed and undisturbed drainage area (5 or more acres discharging into impaired or high quality waters), but where temporary sediment basins are not practical or feasible because of topographical or other physical constraints, equivalent control measures must be used until final stabilization of the site. Examples of equivalent control measures include combinations of multiple, smaller sediment ponds and sediment traps or other proven treatment processes. Where equivalent control measures are substituted for a sediment basin, the basis of and equivalency for trapping sediment using other BMPs must be justified in the SWPPP calculations and narrative to TDEC in terms of equivalent volume, surface area, and hydraulic capacity. The total trapping capacity of these must have an equivalent storage of 3,618 cubic feet (134 cubic yards) of runoff per acre. The total surface area must meet the minimum surface area requirement of  $0.01 \times Q_p$ . The measure must be able to convey the design storm (2- or 5-year, 24-hour storm, as required).

### **Construction Specifications**

Construction of the sediment basin shall be in accordance with the SWPPP, engineering drawings and specifications. Accurate implementation of specified design elevations, grades, dimensions and sizes, volumes, channel slopes, and erosion control materials are critical to successful and safe operation of the sediment basin. Elevations and dimensions should be constructed within  $\pm 0.1$  feet tolerance.. After construction the design engineer or landscape architect shall inspect the sediment basin, according to Site Assessment requirements, to confirm that the plans have been accurately implemented.

**Plans and Specifications:** The construction plans shall contain sufficient detail in the form of layout, typical details, elevations, dimensions, placement, and specification notes so that the designer's intent can be understood and be properly constructed.

**Site Preparation:** Areas under the proposed embankment (or any structural works related to the sediment basin) shall first be cleared, grubbed, and stripped of topsoil. All trees, vegetation, roots, and/or other objectionable or inappropriate materials should be removed and disposed of by appropriate methods. In order to facilitate clean out and restoration, the pool area should be cleared of all brush and trees.

**Cut-Off Trench:** For earth-fill embankments, a cutoff trench shall be excavated along the centerline of the earth fill embankment (dam) to prevent excessive seepage and possible internal erosion. The trench must extend at least 1 foot into a stable, impervious layer of soil and have a minimum depth of 2 feet. The cutoff trench shall extend up both abutments to the riser crest elevation. The minimum width shall be 4 feet, but also must be wide enough to permit operation of compaction equipment. The side slopes shall be no steeper than 1:1. Compaction requirements shall be the same as those for the embankment. The trench shall be drained during the backfilling/compacting operations.

**Embankment:** The fill material shall be taken from approved borrow areas (shown on the plans). It shall be clean mineral soil, free of roots, woody vegetation, stumps, sod, oversized stones, rocks, or other perishable or objectionable material. The fill material selected must have enough strength for the dam to remain stable and be

tight enough, when properly compacted, to prevent excessive percolation of water through the dam. Fill containing particles ranging from small gravel or coarse sand to fine sand and clay in desired proportion is appropriate. Any embankment material should contain approximately 20% clay particles by weight. Using the Unified Soil Classification System, SC (Clayey sand), GC (clayey gravel) and CL (“low liquid limit” clay) are among the preferred types of embankment soils. Areas on which fill is to be placed shall be scarified prior to placement of fill. The fill material should contain the proper amount of moisture to ensure that at least 95% compaction will be achieved. **Fill material will be placed in 6-inch continuous layers over the entire length of the fill.** Loosely placed embankment soil is subject to excessive settlement, severe erosion and slope failure. Compaction shall be obtained by routing the hauling equipment over the fill so that the entire surface of the fill is traversed by at least one wheel or tread track of the equipment, or by using a compactor. Note that the spillway barrel must be installed in the embankment as it is being constructed in lifts and proper compaction is occurring around the barrel, especially under the haunches. Special care shall be taken in compacting around the anti-seep collars (compact by hand, if necessary) to avoid damage and achieve desired compaction. The embankment shall be constructed to an elevation 10% higher than the design height to allow for settlement if compaction is obtained with hauling equipment. If compaction equipment is used, the overbuild may be reduced to not less than 5%. All components of the embankment must be stabilized with vegetation after construction is complete.

**Principal Spillway:** The riser of a metal pipe principal spillway shall be securely attached to the barrel pipe by welding the full circumference, making a watertight connection. The barrel and riser shall be placed on a firmly compacted soil foundation. The base of the riser shall be firmly anchored according to design criteria to prevent it from floating. Pervious materials such as sand, gravel, or crushed stone shall not be used as backfill around the barrel or anti-seep collars. Fill material shall be placed around the pipe in 4- inch layers and compacted until 95% compaction is achieved (compact by hand, if necessary). A minimum of two feet of fill shall be hand-compacted around and over the barrel before crossing it with construction equipment. An antiflotation device shall be constructed to prevent movement of the barrel and riser. A trash rack shall be properly fitted and attached to the principal spillway inlet. Soil should be hand-tamped around the pipe barrel, especially below the haunches, to achieve good compaction around the pipe and to prevent damage to the joints and antiseep collars.

**Dewatering device:** If a skimmer dewatering device is installed, attach a rope or other mechanism to the skimmer arm to retrieve it from the pond for cleaning. Install a rock or concrete pier for the skimmer to rest on. The pier should be at the elevation of the wet storage pool.

**Emergency Spillway:** The emergency spillway shall be installed in undisturbed ground. The implementation of planned elevations, grades, design width, entrance and exit channel slopes are critical to the successful operation of the emergency spillway and must be constructed within a tolerance of +/-0.1 feet. The emergency spillway should be protected against scouring and erosive shear stress. The spillway should be over-excavated to compensate for the thickness of linings such as rock rip rap in order to preserve its intended design flow capacity.

**Inlets:** Discharge water into the basin in a manner to prevent erosion and turbulence. Use diversions with outlet protection to divert sediment-laden water to the upper end of the pool area to prevent pond shortcutting and to improve basin trapping efficiency.

**Baffles:** At least two baffles shall be installed in the forebay. These should be installed as shown in Figures 7-31-2A and -2B and per Section 7.33.

**Vegetative Stabilization:** The embankment and emergency spillway of the sediment basin shall be stabilized immediately after construction of the basin. Trees and/or shrubs should not be allowed to grow upon the embankment due to the ability for the roots of such vegetation to destabilize the embankment and/or encourage piping.

**Erosion prevention and sediment control:** The construction of the sediment basin shall be carried out in a manner such that it does not result in sediment problems downstream.

**Health and Safety:** All state and local requirements shall be met concerning fencing and signs warning the public of the hazards of soft, saturated sediment and flood water. Avoid steep side slopes, and fence - mark basins with warning signs, especially in urban areas where trespassing is likely. The designer and developer should be aware of the potential hazards that a temporary wet pond represents to the health and safety of a neighborhood. Sediment basins can be attractive to children and can be dangerous to those who may accidentally slip into the water and soft mud or who may become entrapped at flowing inlets. Incidents have been reported involving children drowning at construction site sediment ponds. The basin area should, therefore, be fenced or otherwise made inaccessible to persons or animals, unless this is deemed unnecessary due to the remoteness of the site or other circumstances. Strategically placed signs around the impoundment reading "DANGER KEEP OUT" or "DANGER-QUICKSAND" should also be installed. In addition to signs and fences, consideration should be given to frequent inspection, regular maintenance and provision for security at such facilities. Special consideration may need to be given in pond design, operation and maintenance in areas of the state where health hazards stemming from mosquito breeding and West Nile Virus have occurred. In any case, local ordinances and regulations regarding health and safety must be adhered to.

**Final Disposal:** When temporary structures have served their intended purpose and the contributing drainage area has been properly stabilized, and unless the sediment pond is scheduled for conversion into a permanent stormwater detention facility, the embankment and resulting sediment deposits are to be leveled or otherwise disposed of in accordance with the SWPPP. The proposed use of a sediment basin site will often dictate final disposition of the basin and any sediment contained therein. If the site is scheduled for future construction, then the embankment and trapped sediment must be removed, safely disposed of, and backfilled with a structural fill. When the basin area is to remain open space, the pond may be pumped dry, graded and backfilled.

**Maintenance  
and Inspection  
Points**

Sediment shall be removed from the forebay (and upstream energy dissipation structure, if provided) when 50% of the storage has been filled with sediment. Removing sediment from the dry forebay is much easier than removing sediment from the wet portion of the sediment basin. Also, sediment should be removed from the wet portion of the basin before the sediment level reaches higher than 1 foot below the bottom of the dewatering orifice, or before one-half of the permanent pool volume has been filled in, whichever occurs first. Plans for the sediment basin should indicate the methods for properly disposing of sediment removed from the basin. Possible alternatives are to use the material in fill areas on-site or removal to an approved off-site location.

Accumulated sediment shall be removed from the basin as specified in the SWPPP and/or plan sheets. Sediment shall not enter adjacent streams or drainage ways during sediment removal or disposal. The sediment shall not be deposited downstream from the embankment, adjacent to a stream or floodplain.

Other inspection check points include:

- Inspect storage areas for stabilization of accumulated sediments.
- Check for erosion at the entrances into the basin. These areas should be stabilized to reduce basin maintenance needs.
- Check for blocked spillway systems, including dewatering devices. Remove debris from the basin that may get lodged in the spillways.
- Clean dewatering device(s)
- Check for evidence of piping and internal erosion along the principal spillway barrel by inspecting for embankment crest cracks and subsidence over the barrel and for lost embankment soil appearing at the outlet from along the outside surface of the discharge pipe. Most embankment failures occur at this point.
- If possible, look up the inside of the outlet pipe with a flashlight to check for joint failures
- Inspect the entire embankment for
  - o Evidence of erosion or significant settling
  - o Downstream slope bulges
  - o Structural instability (initial formation of slides)
  - o Longitudinal and lateral cracking
- Inspect downstream from the outlet structures for evidence of erosion.
- Inspect the baffles to ensure they are properly anchored and haven't deteriorated.

**References**

*Barfield, B. J. and M.L. Clar, Erosion and Sediment Control Practices, Report to the Sediment and Stormwater Division, Maryland Water Resources Administration, 1986.*

*TDOT Design Division Drainage Manual*

*North Carolina Erosion and Sediment Control Planning and Design Manual*



## SEDIMENT CONTROL PRACTICES

### 7.32 SEDIMENT TRAP



SEDIMENT TRAP

**Definition** A temporary sediment storage area with a permanent pool, formed by an embankment or excavation, or combination.

**Purpose** To detain sediment-laden runoff from small, disturbed areas, allowing larger sediment particles to settle out of runoff.

**Conditions Where Practice Applies** Sediment traps, along with other controls intended to retain sediment, should be constructed as a first step in any land disturbing activity and should be made functional before upslope land disturbance takes place. The sediment trap may be constructed either independently or in conjunction with a diversion. Sediment should be periodically removed from the trap to maintain the required volume. The SWPPP should detail how excavated sediment is to be disposed of, such as by use in fill areas on site or removal to an approved off-site location.

This practice is applicable for use in applications such as:

- At the outlets of diversions, channels, slope drains, or other runoff conveyances that discharge sediment-laden runoff.
- Below areas that are draining < 5 acres.
- Where access can be maintained for sediment removal and proper disposal.
- In the approach to a stormwater inlet location below a disturbed area as part of an inlet protection system.

Sediment traps are **not** to be located in a stream.

**Planning Considerations** Select locations for sediment traps during site evaluation. Note natural drainage divides and select trap sites so that runoff from potential sediment producing areas can easily be diverted into traps. Diversion berms and ditches should be installed to direct runoff into traps as needed. Ensure the drainage areas for each trap does not



exceed 5 acres.

Sediment traps must be readily accessible for periodic sediment removal and other necessary maintenance. Locations should be planned for sediment disposal as part of trap site selection; disposal areas should be clearly designated in the SWPPP and on construction plans.

The maximum usable life of a sediment trap should be no longer than 2 years. Traps should be installed in the first stages of project development before any land disturbance activity upslope takes place.

### Design Criteria **Storage Capacity:**

The trap shall have an initial storage volume of 3618 cubic feet (134 cubic yards) per acre of **drainage** area. The required storage volume may also be determined by modeling soil loss using RUSLE or other approved methods. Half of the storage volume must be in the form of a permanent pool or wet storage to provide better settling efficiency. To provide the wet storage area, the sediment storage zone will have to be over excavated below the surrounding ground elevation. The other half of the sediment storage is in the form of a draw down or dry storage that provides extended settling time during storm events. The volume of the wet storage area is measured from the low point of the excavated area to the base of the outlet structure. The volume for dry storage is measured from the base of the outlet to the crest of the outlet overflow. See Figures 7.32-1 for notation.

For a sediment trap, the wet storage volume may be approximated by average end method as follows:

$$V_1 = \left[ \frac{(A_0 + A_1)}{2} \right] x D_1$$

where,

$V_1$  = the wet storage volume in cubic feet

$A_0$  = the surface area of the bottom of the trap in square feet

$A_1$  = the surface area of the flooded area at the base of the outlet in square feet

$D_1$  = the maximum depth in feet, measured from the low point in the trap to the base of the outlet

The dry storage volume may be approximated by the average end method as follows:

$$V_2 = \left[ \frac{(A_1 + A_2)}{2} \right] x D_2$$

where,

$V_2$  = the dry storage volume in cubic feet.

$A_1$  = the surface area of the flooded area at the base of the outlet in square feet

$A_2$  = the surface area of the flooded area at the crest of the outlet (overflow mechanism) in square feet

$D_2$  = the depth in feet, measured from the base of the outlet to the crest of the outlet

**Trap efficiency:**

The following design elements must be provided for adequate trapping efficiency:

- Provide a surface area of 0.01 acres (435 square feet) per cfs based on the 2-year or 5-year storm
- Convey runoff into the trap through stable diversions or temporary slope drains
- Locate sediment inflow to the trap away from the outlet to prevent short circuiting from the inlet to the outlet
- Provide at least 2 porous baffles (see Section 7.33)
- Excavate the wet storage volume,  $V_1$ , below grade.

The sediment storage area should have a length to width ratio of 3:1, measured from the point of maximum runoff introduction to outlet. Settling efficiency is improved with longer flow paths and residence time in the sediment storage zone.

**Spillway:**

The spillway is constructed of rip rap and smaller graded, clean stone such as TDOT #57 stone. Geotextile fabric must be placed between the rip rap and soil to prevent piping and erosion of the spillway. A four (4) foot minimum weir width must be provided (See Figure 7.32-1). The weir section of the spillway must be designed to pass the 2-year or the 5-year storm event, based upon the total drainage area.

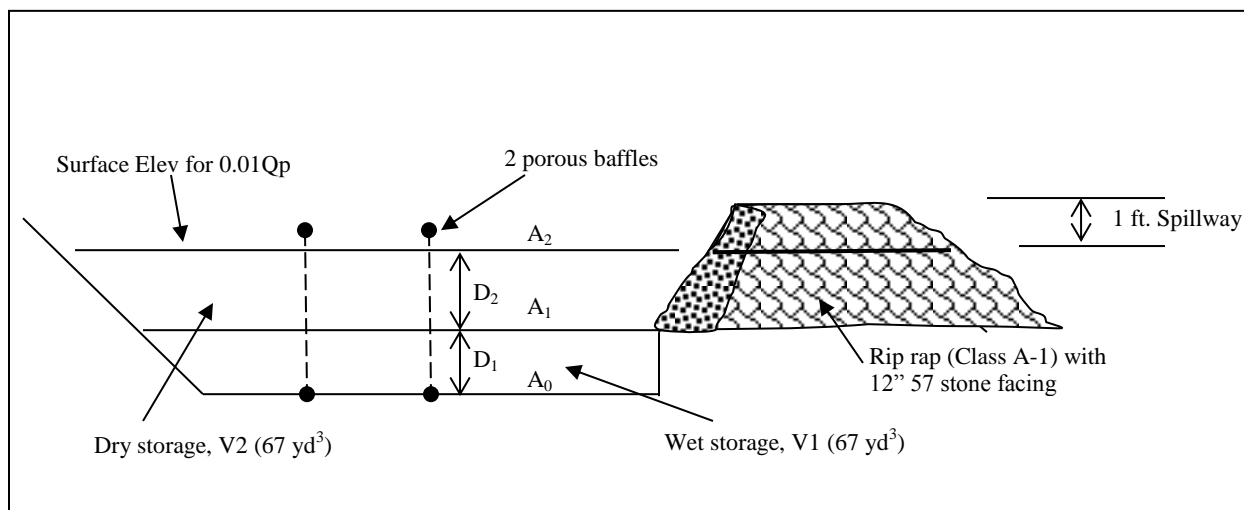

**Figure 7.32-1 Sediment trap**

**Embankment:**

The embankment should be no taller than five (5) feet. Side slopes must be 2:1 or flatter and stabilized as soon as construction on the trap has been completed. Keep the crest of the spillway outlet 1.5 feet below the settled top of the embankment. Embankments must have a minimum top width of 5 feet. Machine compact embankments.

**Construction Specifications**

1. Clear, grub, and strip the area under the embankment of all vegetation and root mat. Remove all surface soil containing high amounts of organic matter, and stockpile it or dispose of it properly. Haul all objectionable material to the designated disposal area.
2. Ensure that fill material for the embankment is free of roots, woody vegetation, organic matter, and other objectionable material. Place the fill in lifts not to exceed 9 inches, and machine compact it. Overfill the embankment 6 inches to allow for settlement.
3. Construct the outlet section in the embankment. Protect the connection between the riprap and the soil from piping by using geotextile fabric between the rip rap and soil. Place the filter fabric between the soil and rip rap. Extend the fabric across the spillway foundation and sides to the top of the dam.
4. Clear the sediment trap storage zone area below the elevation of the crest of the spillway to facilitate cleanout.
5. All cut and fill slopes must be 2:1 or flatter.
6. Ensure that the stone section of the embankment has a minimum bottom width of 3 feet and maximum side slopes of 1:1 that extend to the bottom of the spillway section.
7. Construct the minimum finished stone spillway bottom width, as shown on the plans, with 2:1 side slopes extending to the top of the over filled embankment. The weir must be level and constructed to the width noted on the plans.
8. Material used in the stone section should be a well graded mixture of stone with a  $d_{50}$  size of 9 inches (Class A-1). The stone can be machine placed and the smaller stones worked into the voids of the larger stones.
9. Runoff should be discharged into the trap in a manner to prevent erosion. Use temporary slope drains or diversions with outlet protection to divert runoff to the upper end of the storage area to improve trap efficiency. Avoid discharging runoff over unprotected steep side slopes.
10. Ensure that the stone spillway outlet section extends downstream past the toe of the embankment until stable conditions are reached and outlet velocity is acceptable for the receiving system. Keep the edges of the stone section flush with the surrounding ground.
11. Stabilize the embankment and all disturbed areas above the sediment pool and downstream from the trap immediately after construction.
12. Install at least two porous baffles as specified in Section 7.33.

**Maintenance  
and Inspection  
Points**

Sediment traps must be maintained and function as designed until all areas draining to the trap have been stabilized.

The structure should be checked regularly to ensure that it is structurally sound and has not been damaged by erosion or construction equipment. The height of the stone outlet should be checked to ensure that its center is at least 1 foot below the top of the embankment.

Any rip rap displaced from the spillway must be replaced immediately.

Filter stone should be checked to ensure that filtration performance is maintained. Replace stone caked with sediment.

Sediment shall be removed when it has accumulated to one half the design volume of the wet storage. Sediment removed from the trap should be deposited in an area up gradient from the sediment trap and other measures and stabilized or removed from the site. Do not place removed sediment below sediment controls.

Once the areas draining to the sediment trap have been stabilized, remove the stone and rip rap spillway and backfill the sediment storage area. Stabilize the area.

**References**

*TDOT Design Division Drainage Manual*

*TDOT Erosion Control Standard Drawing EC-STR-7*

*North Carolina Erosion and Sediment Control Planning and Design Manual*

## SEDIMENT CONTROL PRACTICES

### 7.33 POROUS BAFFLES



■ — ■ Baffles

- Definition** Porous baffles are made of highly porous materials such as coir or jute netting. Porous baffles installed inside temporary sediment traps and sediment basins reduce the velocity and turbulence of the water flowing through the measure, distribute the flow, and facilitate the settling of sediment from the water before discharge.
- Purpose** Improve the rate of sediment settling by distributing the flow and reducing turbulence. Sediment traps and basins are designed to temporarily pool runoff water to allow sediment to settle before the water is discharged. Unfortunately, these measures are not typically very efficient due to high turbulence and short circuiting flows which take runoff quickly to the outlet with little residence time for settling to occur.
- Conditions Where Practice Applies** Baffles can be installed in any temporary sediment trap or sediment basin. A secondary benefit of installing porous baffles in sediment traps and basins is that the majority of the sediment load tends to settle on the upstream side of the first porous baffle, making maintenance and cleanout of the sediment storage area much easier.
- Planning Considerations** Porous baffles effectively spread the flow across the entire width of a sediment basin or trap. Water flows through the baffle material but is slowed sufficiently to back up the flow, causing it to spread across the entire width of the baffle. Spreading the flow in this manner utilizes the full cross section of the sediment storage area, which in turn reduces the flow rates. In addition, turbulent flow is reduced. This combination increases sediment deposition and retention and also decreases the particle size of sediment settling in the storage area.

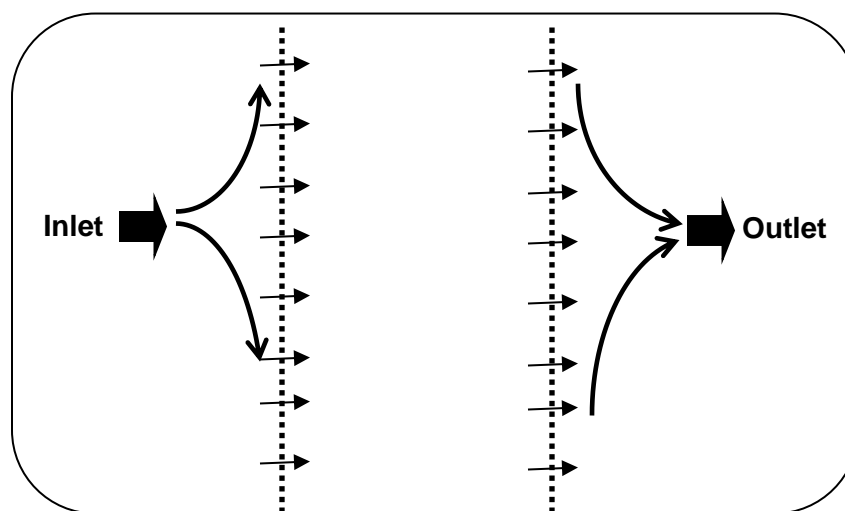

Figure 7.33-1 Porous baffle spreading flow in a sediment trap

Installation of porous baffles is similar to silt fence. The baffles must be installed perpendicular to flow in the sediment storage area. At least two baffles must be installed to be most effective.

**Design Criteria** Refer to the design for sediment basins and sediment traps (Section 7.31-7.32).

The porous baffles should be shown on the design plans (and installed in the field) to divide the basin into three sections.

Materials such as 0.14 lb/ft<sup>2</sup> (20 oz/yd<sup>2</sup>) coir erosion blanket, coir mesh, or jute fabric can be used to construct the baffle. See Table 7.33-1 for material specifications for coir baffles. Silt fence material is not porous enough to allow enough flow through the material fast enough and can therefore have flow over the material and cause turbulent flow on the downstream side, so it is not recommended. Wire backing can be installed to provide structural support for the baffles between posts. A support wire or rope across the top will help prevent excessive sagging if the material is attached to it with strong zip ties or similar fastenings. These structures work well and can be prefabricated off site and quickly installed.

Table 7.33-1 Coir Baffle Material Specifications (Source: NCDOT)

100% coconut fiber (coir) twine woven into high strength matrix	
Thickness	0.30 in. minimum
Tensile strength	1248 x 626 lb/ft minimum
Elongation	34% x 38% maximum
Flexibility (mg-cm)	65030 x 29590
Flow velocity	Observed 11 ft/sec
Weight	20 oz/yd <sup>2</sup>
Size	6.6 x 164 ft (120 yd <sup>2</sup> )
Open area	50%



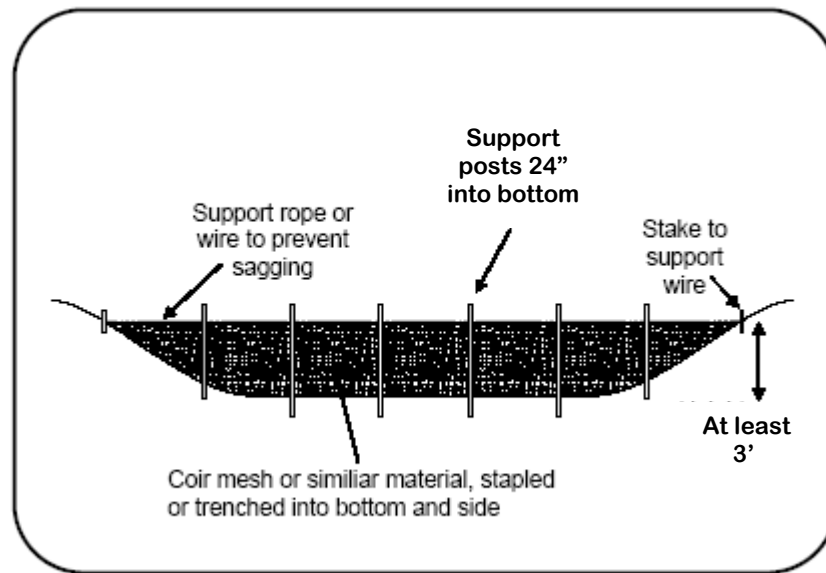

Figure 7.33-2 Cross section of a porous baffle in a sediment trap (Source: NCDENR)

Note that in Figure 7.33-2 there is no weir in the baffles because water flows through the porous baffle, not over it.

### Construction Specifications

#### Staples

- Provide staples made of 0.125 in. diameter new steel wire formed into a *u* shape not less than 12" in length with a throat of 1" in width.

#### Posts

- Steel posts shall be T-type at least 5 ft. in length, approximately 1 3/8" wide measured parallel to the fence, and have a minimum weight of 1.25 lb/ft of length. The post shall be equipped with an anchor plate having a minimum area of 14.0 square inches, and shall be of the self-fastener angle steel type to have a means of retaining wire and coir fiber mat in the desired position without displacement.

#### Wire

- Provide 9-gauge high tension wire strand of variable lengths.

#### Construction

Place the coir fiber baffles immediately upon excavation of basins or traps. Install baffles as required in Sections 7.31 Sediment basins and 7.32 Sediment traps. Steel posts shall be placed at a depth of 2 ft. below the bottom of the basin, with a maximum spacing of 4 ft. The top height of the coir fiber baffles shall not be below the elevation of the emergency spillway base of dams and basins. Attach a 9-gauge high-tension wire strand to the steel posts at a height of 3 ft. with plastic ties or wire fasteners. To anchor the coir fiber mat, install a steel post into the side of the basin at a variable depth at a height of 3 ft. from the bottom of the basin. Secure anchor post to the upright steel post in basin with wire fasteners.

The porous baffle material shall be draped over the wire strand to a minimum of 3 ft. of material on each side of the strand. Secure the baffle material to the wire strand with plastic ties or wire fasteners. Place staples across the matting at ends and junctions approximately 1 ft. apart at the bottom and side slopes of the basin or trap. Overlap matting at least 6" where 2 or more widths of matting are installed side by side.

**Maintenance  
and Inspection  
Points**

- Inspect the sediment deposition cells created by the baffles. Heavier sediments will accumulate in the upper most cell.
- Clean sediment from the cells when half of the storage capacity depth has been filled.
- Ensure that baffle material stays securely installed along the sediment trap sides and in the bottom. Material should stay taut across the trap.
- Watch for scour along the sides of the baffle.
- Replace baffle material if torn or if evidence of deterioration is noted.

**References** *North Carolina State University Cooperative Extension, Soil Facts*

*North Carolina Department of Environment and Natural Resources, Erosion and Sediment Control Planning and Design Manual*

*North Carolina Department of Transportation, Roadside Environmental Details*

## SEDIMENT CONTROL PRACTICES

### 7.34 SILT FENCE



SILT FENCE

**Definition** A temporary sediment control measure, composed of woven geotextile fabric supported by steel or wood posts, used to intercept sediment transported from areas where runoff occurs as sheet flow.

**Purpose** To prevent sediment carried by sheet flow from leaving the site and entering natural drainage ways or storm drainage systems by slowing storm water runoff, causing ponding and the deposition of sediment at the structure. Silt fence does not filter sediment.

**Conditions Where Practice Applies** Silt fence may be used in a variety of locations including:

- at the toe of, or on, an exposed slope
- around the perimeter of an exposed construction site
- along the banks of ditches or swales
- around the perimeter of a soil stockpile
- around buffer areas

**Silt fence shall not be installed across streams, ditches, waterways, or other concentrated flow areas.**

**Planning Considerations** Silt fence is a system to retain sediment on the construction site. The fence retains sediment primarily by retarding flow and promoting deposition. In operation, the geotextile silt fence material ponds runoff behind it, as the flow rate through the geotextile is often much lower than the flow rate of the runoff coming to the silt fence. Ponding behind the silt fence is necessary to encourage sediment settling. The designer should anticipate ponding and provide sufficient storage areas and overflow outlets to prevent flows from overtopping the fence. Since silt fence is not designed to withstand high water levels, locate them so that only shallow pools can form. Tie the ends of silt fence into higher ground to prevent flow around the end of the fence before the pool reaches design level. Silt fence should be curled uphill

on each end of the fence in a “J” pattern to prevent end flow and scour. Provide stabilized outlets to protect the fence system and release storm flows that exceed the design storm.

Deposition occurs as the storage pool forms behind the fence. The designer can direct flows to specified deposition areas through appropriate positioning of the fence or by providing an excavated area behind the fence. Plan deposition areas at accessible points to promote routine cleanout and maintenance.

Silt fence serves no function along ridges or near drainage divides where there is little movement of water. Confining or diverting runoff unnecessarily with a sediment fence may create erosion and sedimentation problems that would not otherwise occur.

Anchoring of silt fence is critical. The toe of the fabric must be anchored in a trench backfilled with compacted earth. Mechanical compaction must be provided in order for the fence to effectively pond runoff.

**Design Criteria** Silt fence should be installed along the contour, never up or down a slope. This is essential to ensure that the fence will not accidentally concentrate stormwater flows, thus creating worse erosion problems.

Silt fence can be installed without backing or with wire backing.

- The maximum drainage area for a continuous fence without backing shall be 1/4 acre per 100 linear feet of fence length, up to a maximum area of 2 acres. The maximum slope length behind the fence on the upslope side should be 110 feet (as measured along the ground surface).
- The maximum drainage area for a continuous silt fence with backing shall be 1 acre per 150 linear feet of fence length. The slope length above the silt fence with backing should be no more than 300 feet.

Silt fence should be installed so as to be as close as possible to the ground contour. The bottom of the fence at the ground line should be on a 0% grade, plus or minus 0.5%.

When used at the bottom of a slope, silt fence should be installed 5 feet to 7 feet away from the toe to allow extra space for the ponding of water and collection of sediments.

The expected life span of the silt fence is 6 to 12 months. Therefore, projects of long duration may require a complete replacement of the silt fence. The quantity for silt fence to be in place for a long period of time should be based on the assumption that the material will be replaced every 9 months, on the average.

Table 7.34-1 contains the fabric specifications for silt fence with and without backing. For silt fence without backing, posts shall be hardwood posts that are 2.25” (nominal) x 2.25” (nominal) x 58”. T-type steel posts also may be used. Silt fence with backing shall be installed on a minimum of 1.25 lb/ft steel posts with 14 gauge wire backing that has a maximum mesh size of 6 inches. Ensure that steel posts have projections for fastening the fabric.

Table 7.34-1 Silt Fence Fabric Specifications

	<b>Test Material</b>	<b>Without backing</b>	<b>With backing</b>
Geotextile fabric type		Woven slit film	Woven monofilament
Apparent opening size	ASTM D4751	#30 to #70 standard sieve	#70 to #100 standard sieve
Water flux	ASTM D4491	≥ 4 gpm/ft <sup>2</sup>	≥ 18 gpm/ft <sup>2</sup>
Tensile strength	ASTM D4632	≥ 120 lb. (warp direction) 100 lb. (fill direction)	≥ 310 lb. (warp direction) 200 lb. (fill direction)
UV Stability (after 500 hrs)	ASTM D4355	≥ 70%	≥ 90%
Elongation	ASTM D4632	≤ 20% max.	---
Burst strength	ASTM D3786	≥ 250 PSI	≥ 400 psi
Puncture strength	ASTM D4833	≥ 60 lb.	≥ 105 lb.
Trapezoidal tear	ASTM D4533	≥ 50 lb (warp direction) 40 lb (fill direction)	≥ 100 lb (warp direction) 60 lb (fill direction)

**Construction Specifications**

- Ensure that the height of the sediment fence does not exceed 24 inches above the ground surface. Ponding water depth should not exceed 1.5 feet. (Higher fences may impound volumes of water sufficient to cause failure of the structure.)
- Construct the filter fabric from a continuous roll cut to the length of the barrier to avoid joints. When joints are necessary, securely fasten the filter cloth only at a support post with 4 feet minimum overlap to the next post or roll the fabric together and fasten to one post to create a stronger joint. Where joints are necessary, plan the roll layout so as not to have joints at low points.
- Do not attach filter fabric to trees.
- When silt fence is installed adjacent to streams, wetlands and other natural resources, silt fence with backing should be used.
- Install posts no more than 6 feet apart.
- Install posts 2 feet deep on the downstream side of the silt fence, and as close as possible to the fabric, enabling posts to support the fabric from upstream water pressure.
- Securely attach the silt fence fabric to the posts on the **upstream** side of the posts. For steel posts, attach fabric to the posts using wire or plastic zip ties with a minimum 50 pound tensile strength, at least 5 to a post. Three ties should be installed in the upper 8 inches for top strength. Ties should be installed on the diagonal, as opposed to on the horizontal, to grab more strands. For hardwood posts, attach fabric with 17 gauge wire staples (3/4" wide x 1/2" long), at least 5 to a post. 3 staples should be installed in the upper 8 inches for top strength.
- Install J-hooks for confining the water behind the fence and maximizing the trapping efficiency. See Figure 7.34-1 below.

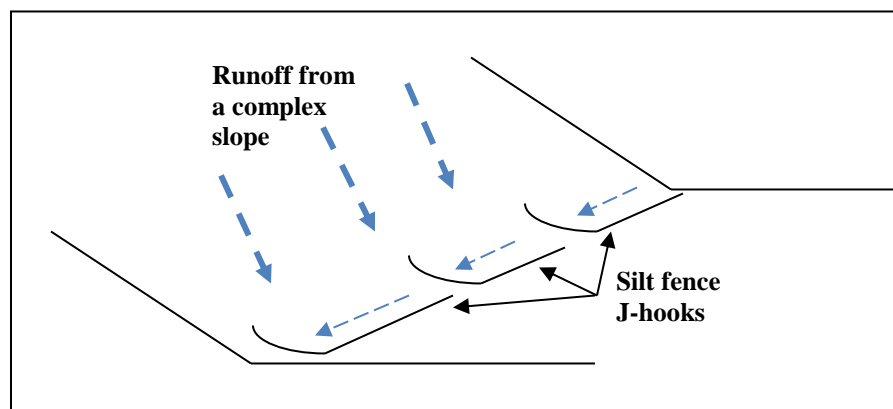

Figure 7.34-1 J-Hook Installation Example



**Traditional silt fence trenching method for installation:**

- Excavate a trench approximately 4 inches wide and 6 inches deep along the proposed line of posts and upslope from the barrier
- Place 10 inches of the fabric along the bottom and side of the trench. Backfill the trench with soil placed over the filter fabric and compact. Thorough compaction of the backfill is critical to silt fence performance. Poor compaction can cause failure of the silt fence along the toe.
- The base of both end posts should be at least one foot higher than the middle of the fence. Check with a level as necessary.

**Slicing method for installation:**

- A slicing machine can be used to install silt fence. This method of installation provides excellent compaction and joint integrity along the toe.
- Posts should be set a maximum of 6 feet apart.
- The geotextile fabric should be inserted in a slit in the soil 8-12 inches deep. The slit should be created such that a horizontal chisel point, at the base of a soil-slicing blade, slightly disrupts the soil upward as the blade slices through the soil. This upward disruption minimizes horizontal compaction and creates an optimal soil condition for mechanical compaction against the geotextile. The geotextile should be mechanically inserted directly behind the soil-slicing blade in a simultaneous operation, achieving consistent placement and depth. No turning over (plowing) of soil is allowed for the slicing method.

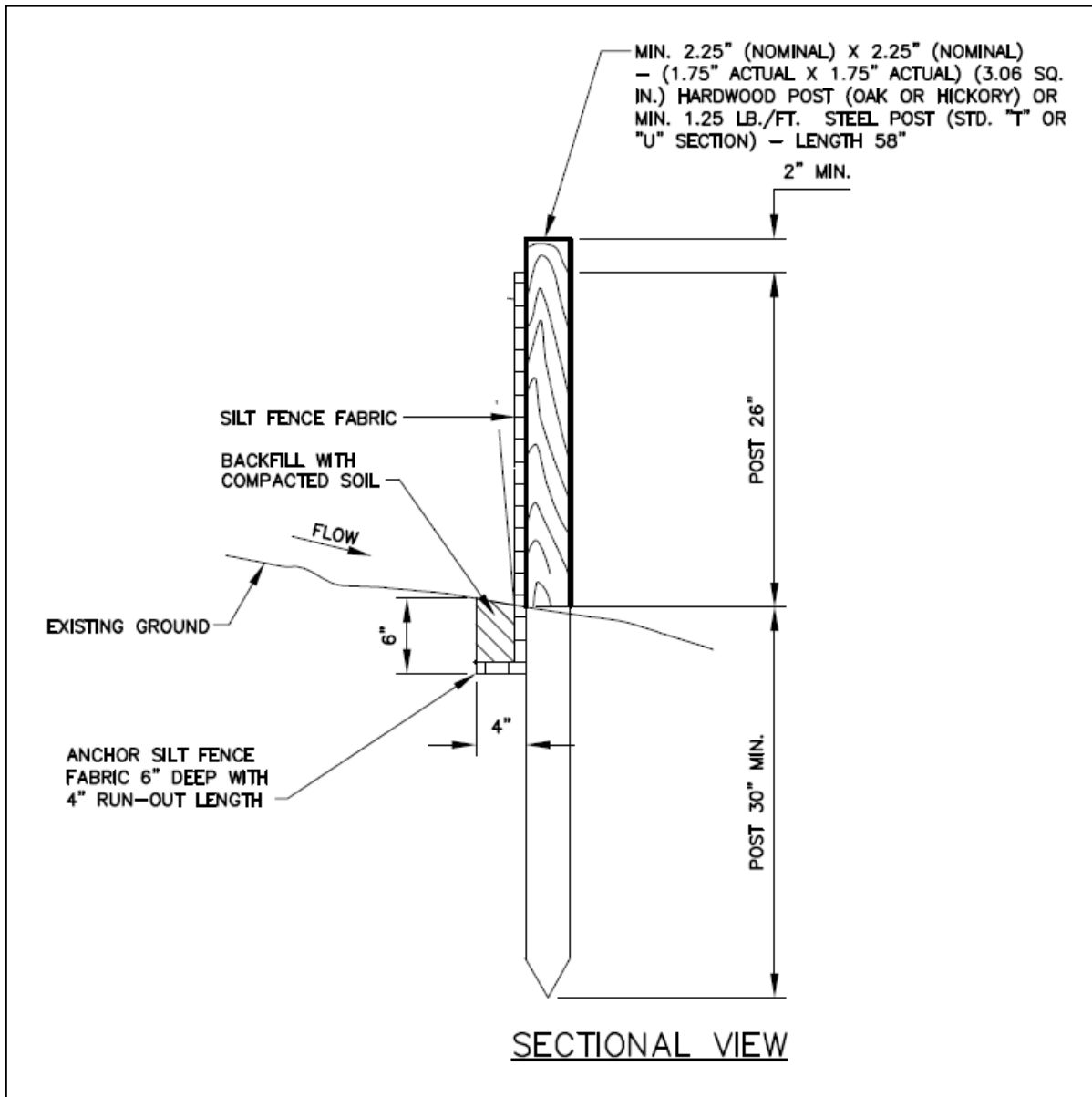

Figure 7.34-2 Silt fence details

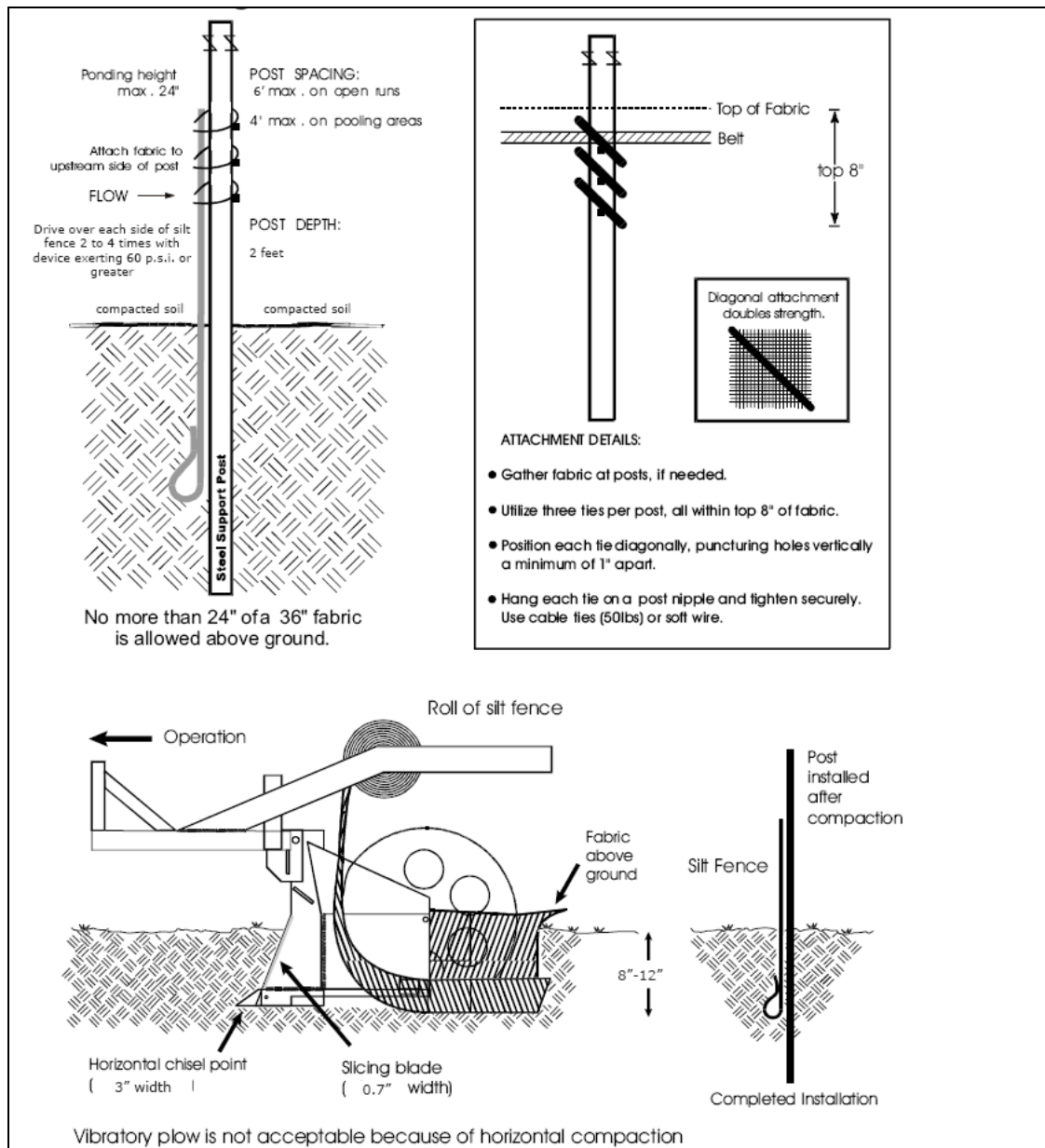

Figure 7.34-3 Silt Fence Slicer Installation Details (Adapted from *Silt Fence That Works*)

**Maintenance  
and Inspection  
Points**

Remove sediment once it has accumulated to  $\frac{1}{2}$  the original height of the barrier.

Replace filter fabric whenever it is worn or has deteriorated to such an extent so that the effectiveness of the fabric is reduced.

All sediment accumulated at the fence should be removed and properly disposed of before the fence is removed.

Repair sagging silt fence to prevent failure or overtopping.

Monitor the toe for evidence of piping or erosion along the toe. Install J-hooks wherever runoff flows along the toe of the fencing to prevent undermining.

Silt fence should remain in place until disturbed areas have been permanently stabilized.

**References**

*TDOT Design Division Drainage Manual*

*TDOT Erosion Control Standard Drawing EC-STR-3B*

*North Carolina Erosion and Sediment Control Planning and Design Manual*

*Devon Distributing Corporation. <http://www.tommy-sfm.com/index.html>*

*Metropolitan Council (Minnesota) Minnesota Urban Small Sites BMP Manual*

## SEDIMENT CONTROL PRACTICES

### 7.35 INLET PROTECTION

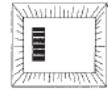

EXCAVATED INLET PROTECTION



HARDWARE CLOTH AND GRAVEL INLET PROTECTION



ROCK RING INLET PROTECTION



BLOCK AND GRAVEL INLET PROTECTION

**Definition** A temporary protective device formed around a storm drain drop inlet to trap sediment.

**Purpose** To prevent sediment from entering the storm drainage system, prior to temporary or permanent stabilization of the disturbed area.

**Conditions Where Practice Applies** Many different types of inlet protection devices are available. The types highlighted in this section are non-manufactured. Manufactured inlet protection devices are allowable alternatives, provided the following:

- At least 3600 ft<sup>3</sup>/acre of drainage is available to store sediment.
- No more than 1 acre of drainage to each measure - 0.5 acre drainage area per each measure is preferable.
- An overflow is provided to safely pass storm events larger than the 5-yr storm.

#### **Non-manufactured inlet protection devices:**

Excavated Drop Inlet Protection is applicable where relatively heavy flows are expected and overflow capability is needed.

Hardware Cloth and Gravel Inlet Protection is applicable where the flow is light to moderate. This method is effective where the inlet is expected to drain shallow sheet flow. The immediate land area around the inlet should be relatively flat (less than 1 percent) and located so that accumulated sediment can be easily removed.

Block and Gravel Inlet Protection is applicable to both drop inlets and curb inlets where heavy flows are expected, and an overflow capacity is necessary to prevent excessive ponding around the structure. Shallow temporary flooding after rainfall however, should be expected.

Sod Drop Inlet Protection is applicable where the drainage area of the drop inlet

has been permanently seeded and mulched, and the immediate surrounding area is to remain in dense vegetation. This practice is well suited for lawns adjacent to large buildings.

Rock Ring Inlet Protection is applicable at drop inlets with large drainage areas or at drop inlets that receive high velocity water flows, possibly from many directions.

Rock Pipe Inlet Protection is applicable at pipes with a maximum diameter of 36 inches. This inlet protection may be used to supplement additional sediment traps or basins at the pipe outlet, or used in combination with an excavated sediment storage area to serve as a temporary sediment trap.

**Silt fence inlet protection is not allowed, as the failure rate for this type of inlet protection is very high.**

### Planning Considerations

Inlet protection should be installed at or around all storm drain drop inlets that receive runoff from disturbed areas. Inlet protection should not be used in streams or other natural water resources. It should also not be placed in ditches, swales or other depressions with a depth greater than 1 foot. Due to the high maintenance requirements, inlet protection should be considered secondary sediment controls and not primary sediment controls. These measures should be used in conjunction with other erosion prevention and sediment control measures to be effective. Exercise installation caution so that stormwater runoff cannot back up out adjacent traffic lanes.

### Design Criteria

#### Excavated Drop Inlet Protection (Figure 7.35-1):

- Limit the drainage area to 1 acre. Keep the minimum depth at 1 foot and the maximum depth of 2 feet as measured from the crest of the inlet structure.
- Maintain side slopes around the excavation no steeper than 2:1
- Keep the minimum volume of excavated area around the drop inlet at approximately 3600 ft<sup>3</sup>/acre of drainage.
- Shape the sediment storage area to fit site conditions, with the longest dimension oriented toward the longest inflow area to provide maximum trap efficiency.
- Install provisions for draining the temporary pool to improve trapping efficiency for small storms and to avoid problems from standing water after heavy rains.

#### Hardware Cloth and Gravel Inlet Protection (Figure 7.35-2):

- Ensure that drainage area does not exceed 1 acre per inlet.
- Secure the wire mesh hardware cloth barriers using steel T posts. The posts need to be 1.25 lb/linear ft steel with a minimum length of 5 feet. Make sure the posts have projections to facilitate fastening the hardware cloth. Securely drive each stake into the ground to a minimum depth of 2 feet. The maximum spacing for the posts is 4 feet.
- The wire mesh should be at least a 19-gauge hardware cloth with a ¼ inch mesh opening. The total height should be a minimum of 2 feet. Providing a



flap of hardware cloth on the ground projecting away from the inlet can aid in removal of the stone at the project's completion. Place #57 washed stone to a height of 16 inches on the upstream face of the cloth with an outside slope of 2:1.

- The top elevation of the structure must be at least 12 inches lower than the ground elevation downslope from the inlet. It is important that all storm flows pass over the structure into the storm drain and not bypass the structure. Temporary dikes below the structure may be necessary to prevent bypass flow.

#### Block and Gravel Inlet Protection (Figure 7.35-3):

- Keep the drainage area no greater than 1 acre unless site conditions allow for frequent removal and adequate disposal of accumulated sediment.
- Keep the height of the barrier at least 12 inches and no greater than 24 inches. Do not use mortar. Limit the height to prevent excess ponding and bypass flow.
- Recess the first course of blocks at least 2 inches below the crest opening of the storm drain for lateral support. Support subsequent courses laterally if needed by placing a 2 x 4-inch wood stud through the block openings that are perpendicular to the block course needing support. Lay some blocks on their side in the bottom row for dewatering the pool.
- Place gravel just below the top of the blocks on slopes of 2:1 or flatter. Place hardware cloth or comparable wire mesh with 1/2-inch openings over all block openings to hold gravel in place.

#### Sod Drop Inlet Protection (Figure 7.35-4):

- Keep velocity of design flow over the sod area at all points less than 5 ft/sec.
- Place sod to form a turf mat completely covering the soil surface for a minimum distance of 4 feet from each side of the drop inlet where runoff will enter.
- Maintain the slope of the sodded area no greater than 4:1.
- Keep the drainage area no greater than 2 acres; maintain this area undisturbed or stabilize it.

#### Rock Ring Inlet Protection:

- Place measure at least 30 feet away from vehicular traffic. This inlet protection can be modified to protect one side of the inlet if only one side receives flow.
- Stone – A minimum 1-foot wide level area set 4 inches below the drop inlet crest will add protection against the entrance of material. Structural stone should be Class A-1 riprap with 2:1 side slope, and a minimum crest width of 18 inches. The height of the stone should be from 2 to 3.5 feet. The outside face of the riprap should be covered in a 12-inch thick layer of #5 or #57 washed stone. Wire mesh with 2-inch openings may be placed over the drain grating but must be inspected frequently to avoid blockage by trash.

- The top elevation of the stone structure must be at least 12 inches lower than the ground elevation downslope from the inlet. It is important that all stormwater flow over the structure into the storm drain, and not past the structure. Temporary diking below the structure may be necessary to prevent bypass flow. Material may be excavated from inside the sediment pool for this purpose.

Rock Pipe Inlet Protection (Figure 7.35-5):

- When used in combination with an excavated sediment storage area to serve as a temporary sediment trap, the design criteria for temporary sediment traps must be satisfied. The maximum drainage area should be 5 acres, and 3600 cubic feet of sediment storage per acre of drainage area should be provided.
- The minimum stone height should be 2 feet, with side slopes no steeper than 2:1. The stone “horseshoe” around the pipe inlet should be constructed of Class A-1 or Class B riprap, with a minimum crest width of 3 feet. The outside face of the riprap should be covered with a 12-inch thick layer of #57 washed stone.
- In preparing plans for rock pipe inlet protection, it is important to protect the embankment over the pipe from overtopping. The top of the stone should be a minimum of 1 foot below the top of the fill over the pipe. The stone should tie into the fill on both sides of the pipe. The inside toe of the stone should be no closer than 2 feet from the culvert opening to allow passage of high flows.
- The sediment storage area should be excavated upstream of the rock pipe inlet protection, with a minimum depth of 18 inches below grade.

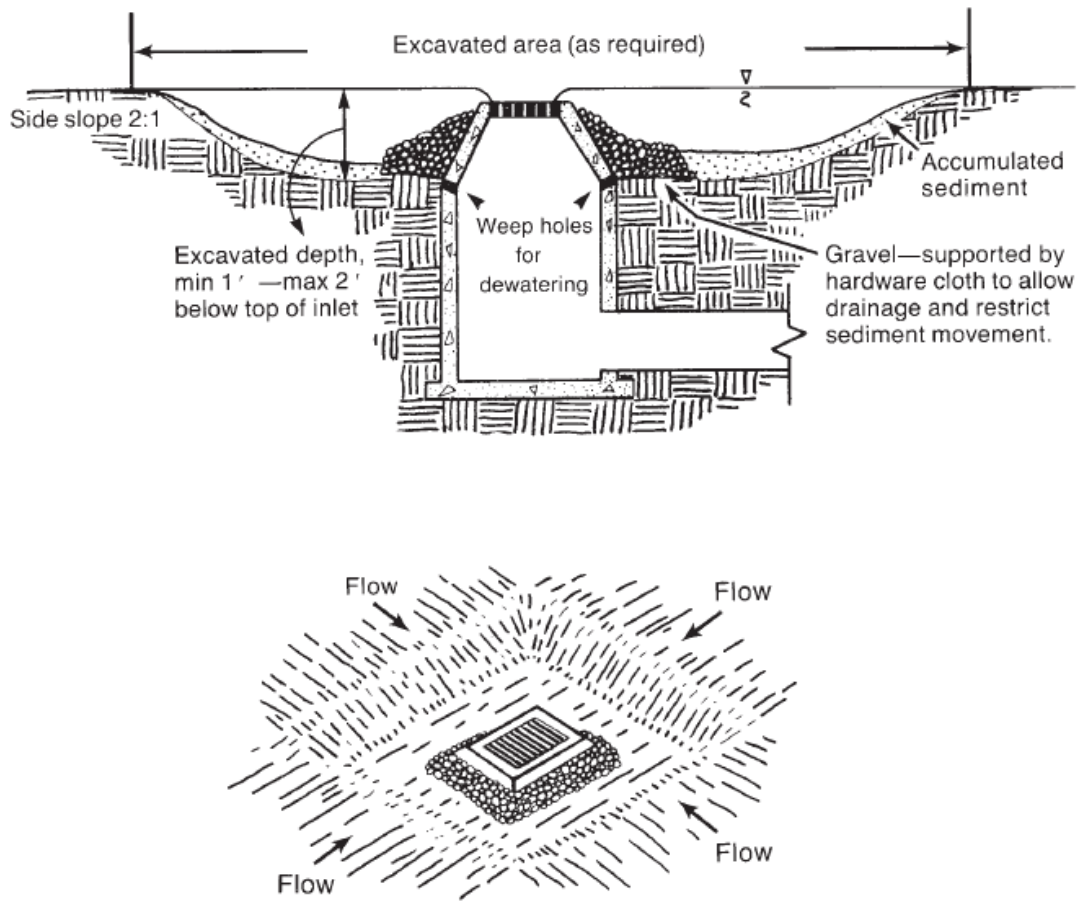

Figure 7.35-1 Excavated Inlet Protection (Source: NCDENR)

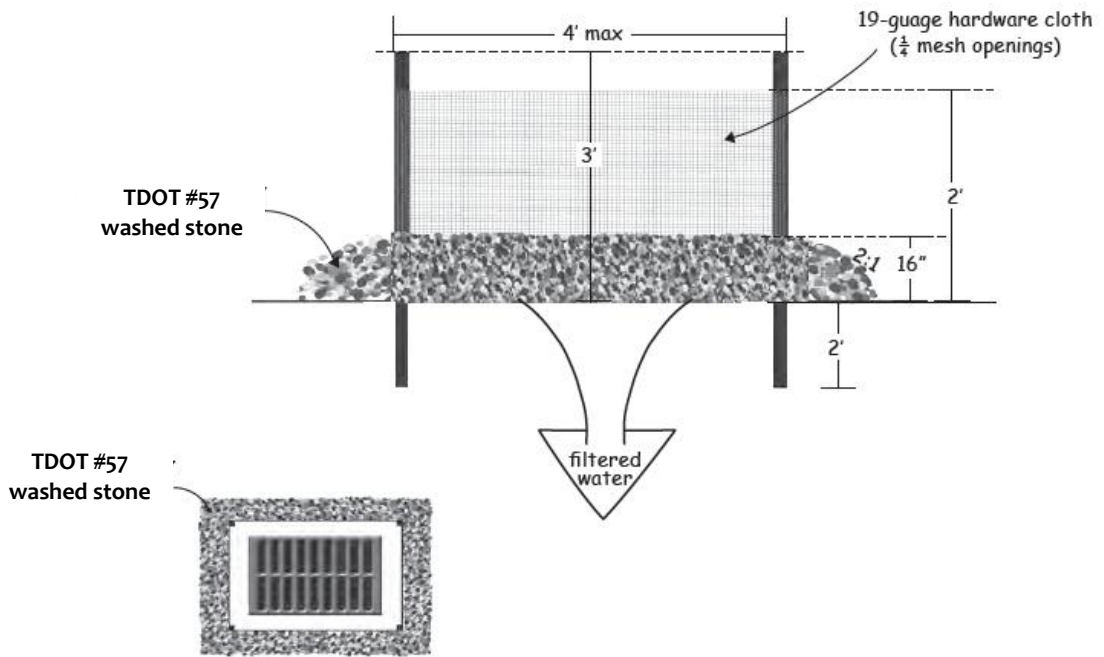

Figure 7.35-2 Hardware Cloth and Gravel Inlet Protection (Source: NCDENR)

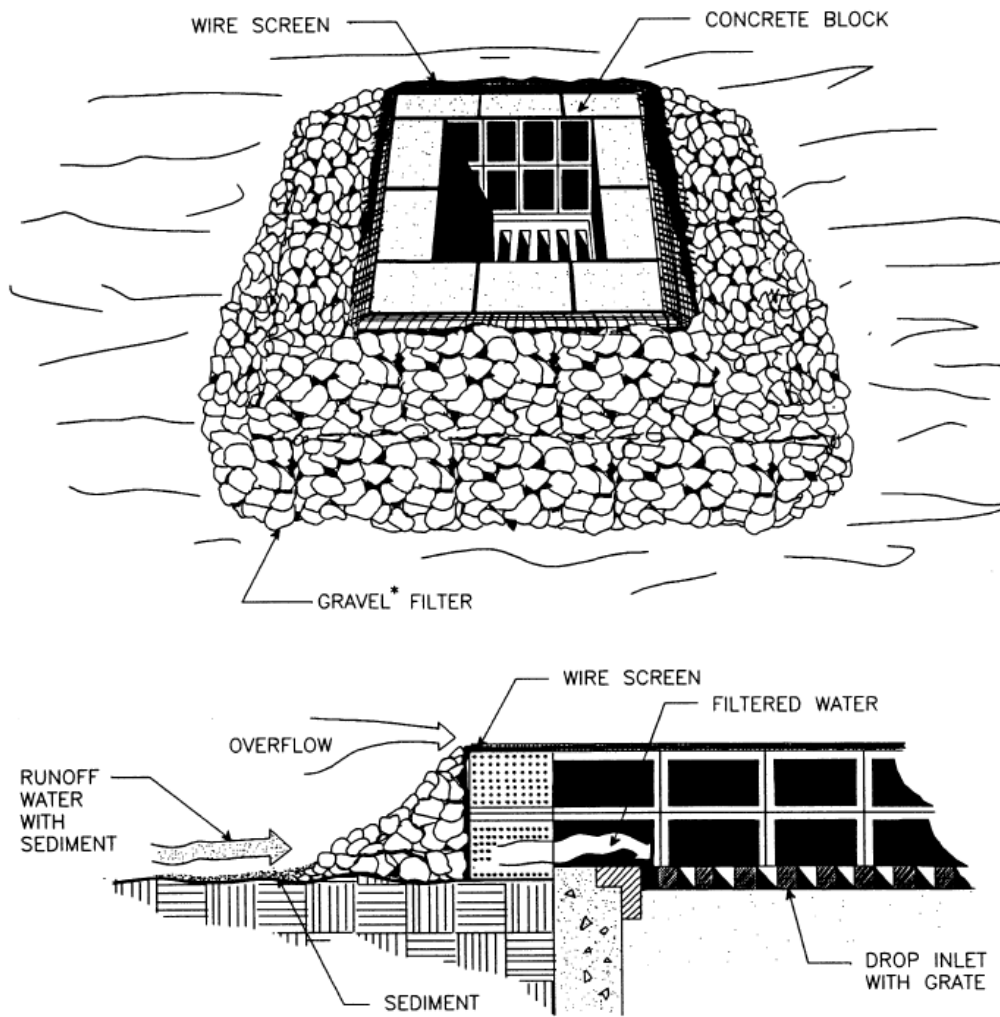

Figure 7.35-3 Block and Gravel Inlet Protection (Source: VA DSWC)

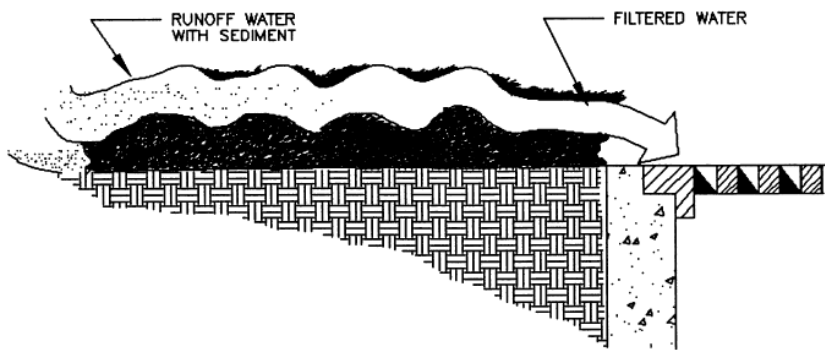
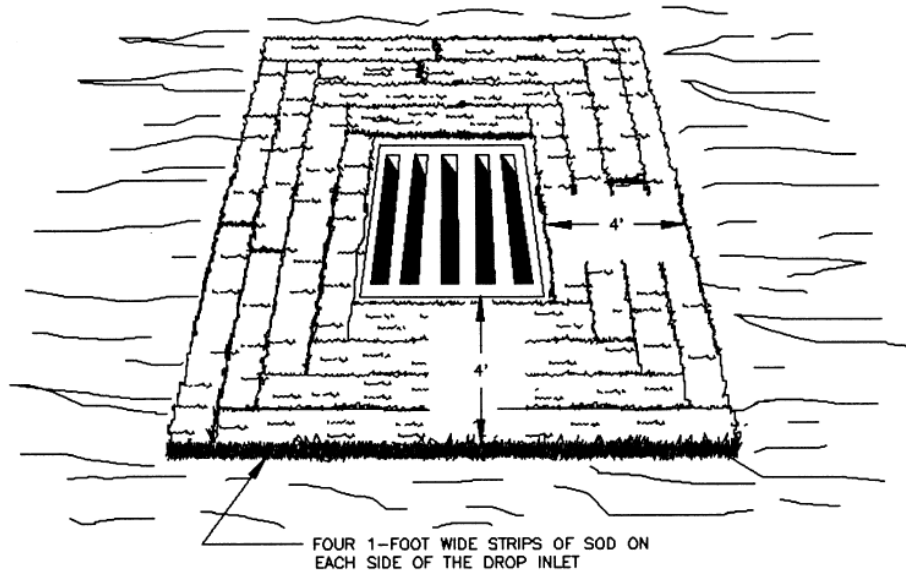

Figure 7.35-4 Sod Inlet Protection Device



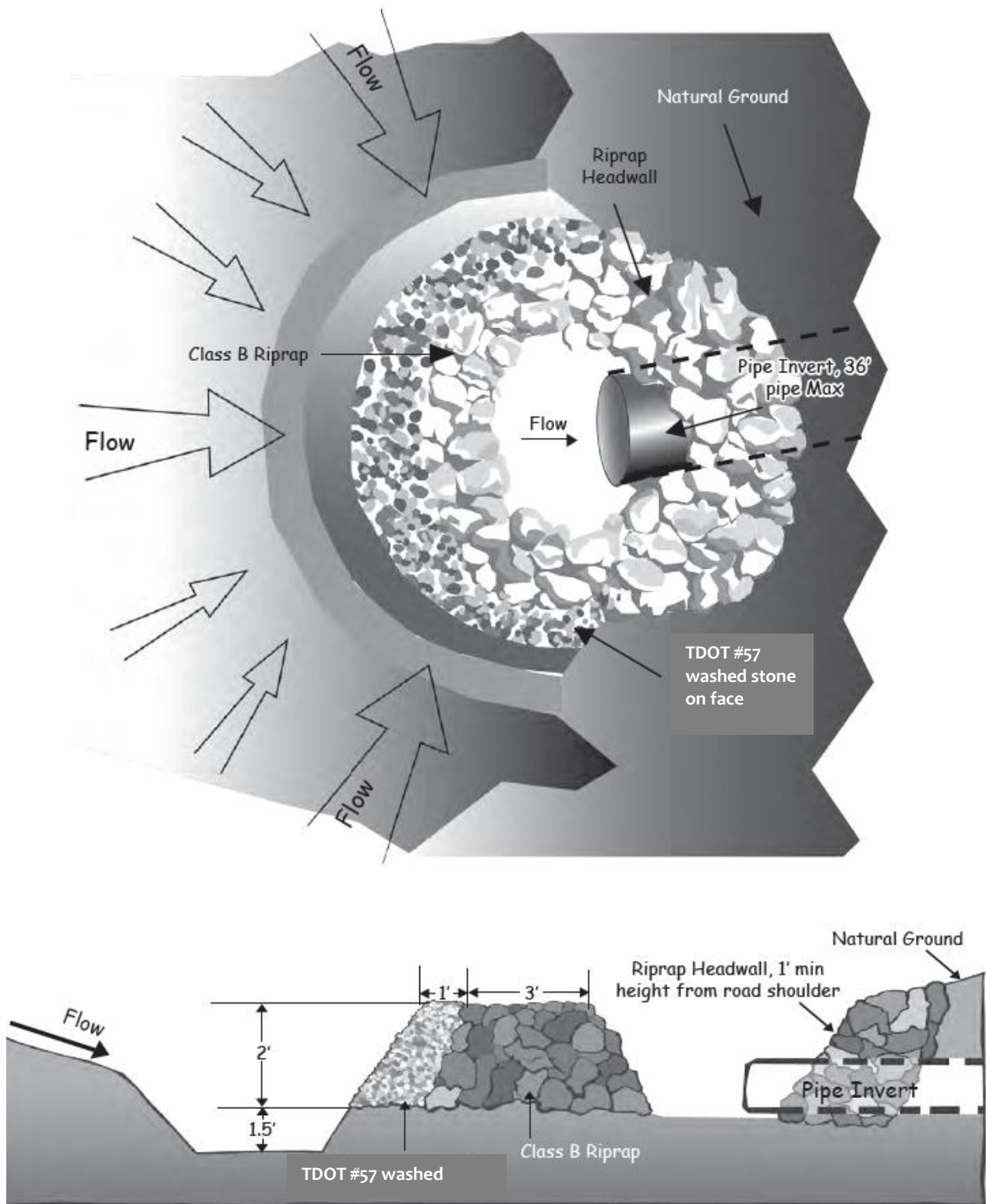

Figure 7.35-5 Rock Pipe Inlet Protection (Source: NCDENR)

**Construction Specifications**

## Excavated Drop Inlet Protection:

- Clear the area of all debris that might hinder excavation and disposal of spoil.
- Grade the approach to the inlet uniformly.
- Protect weep holes by gravel.
- When the contributing drainage area has been permanently stabilized, seal weep holes, fill the basin with stable soil to final grading elevations, compact it properly, and stabilize.

## Hardware Cloth and Gravel Inlet Protection:

- Uniformly grade a shallow depression approaching the inlet.
- Drive 5-foot steel posts 2 feet into the ground surrounding the inlet. Space posts evenly around the perimeter of the inlet, a maximum of 4 feet apart.
- Surround the posts with wire mesh hardware cloth. Secure the wire mesh to the steel posts at the top, middle, and bottom. Placing a 2-foot flap of the wire mesh under the gravel for anchoring is recommended.
- Place clean gravel (#57 stone) on a 2:1 slope with a height of 16 inches around the wire, and smooth to an even grade.
- Once the contributing drainage area has been stabilized, remove accumulated sediment, and establish final grading elevations.
- Compact the area properly and stabilize it with groundcover.

## Block and Gravel Drop Inlet Protection:

- Lay one block on each side of the structure on its side in the bottom row to allow pool drainage. The foundation should be excavated at least 2 inches below the crest of the storm drain. Place the bottom row of blocks against the edge of the storm drain for lateral support and to avoid washouts when overflow occurs. If needed, give lateral support to subsequent rows by placing 2 x 4 wood studs through block openings.
- Carefully fit hardware cloth or comparable wire mesh with ½-inch openings over all block openings to hold gravel in place.
- Use clean gravel, ½- to ¾-inch in diameter, placed 2 inches below the top of the block on a 2:1 slope or flatter and smooth it to an even grade. #57 washed stone is recommended.
- If only stone and gravel are used, keep the slope toward the inlet no steeper than 3:1. Leave a minimum 1-foot wide level stone area between the structure and around the inlet to prevent gravel from entering inlet. On the slope toward the inlet, use stone 3 inches in diameter or larger. On the slope away from the inlet use ½ to ¾-inch gravel (#57 washed stone) at a minimum thickness of 1 foot.

## Sod Drop Inlet Protection:

- Bring the area to be sodded to final grade elevation with top soil. Add fertilizer and lime, if necessary.
- Lay all sod strips perpendicular to the direction of flows.
- Keep the width of the sod at least 4 feet in the direction of flows.
- Stagger sod strips so that adjacent strip ends are not aligned.

**Rock Doughnut Inlet Protection:**

- Clear the area of all debris that might hinder excavation and disposal of spoil.
- Grade shallow depression uniformly towards the inlet with side slopes no greater than 2:1. Grade a 1 foot wide level area set 4 inches below the area adjacent to the inlet.
- Install the Class A-1 or Class B riprap in a circle around the inlet. The minimum crest width of the riprap should be 18 inches, with a minimum bottom width of 7.5 feet. The minimum height of the stone is 2 feet.
- The outside face of the riprap is then lined with 12 inches of #57 washed stone.

**Rock Pipe Inlet Protection:**

- Clear the area of all debris that might hinder excavation and disposal of spoil.
- Install the Class A-1 or Class B riprap in a semi-circle around the pipe inlet. The stone should be built up higher on each end where it ties into the embankment. The minimum crest width of the riprap should be 3 feet, with a minimum bottom width of 11 feet. The minimum height should be 2 feet, but also 1 foot lower than the shoulder of the embankment or diversions.
- A 1 foot thick layer of #5 or #57 stone should be placed on the outside slope of the riprap.
- The sediment storage area should be excavated around the outside of the stone horseshoe 18 inches below natural grade.
- When the contributing drainage area has been stabilized, fill depression and establish final grading elevations, compact area properly, and stabilize with ground cover.

**Maintenance  
and Inspection  
Points**

Sediment should not be allowed to wash into the inlet. It should be removed from the inlet protection and disposed of and stabilized so that it will not enter the inlet again. Remove sediment from the deposition areas when half the height of the storage area has been filled.

Check measure for damage or evidence of erosion and bypassing around the inlet protection. If inlets are in series, runoff that bypasses an upgradient inlet can overwhelm a downgradient inlet protection device. Sand bags, diversions, or other methods should be used to direct runoff into storm drain inlets.

When the contributing drainage area has been permanently stabilized, all materials and any sediment should be removed, and either salvaged or disposed of properly. The disturbed area should be brought to proper grade, then smoothed and compacted. Appropriately stabilize all disturbed areas around the inlet.

**References**

*TDOT Design Division Drainage Manual*

*TDOT Erosion Control Standard Drawing EC-STR-11*

*North Carolina Erosion and Sediment Control Planning and Design Manual*

## SEDIMENT CONTROL PRACTICES

### 7.36 CONSTRUCTION ROAD STABILIZATION



**CRS**

CONSTRUCTION ROAD  
STABILIZATION

- Definition** The stabilization of temporary construction access routes, on-site vehicle transportation routes, and construction parking areas.
- Purpose** To provide a stabilized surface for construction traffic, and to reduce erosion and subsequent re-grading of permanent roadbeds between the time of initial grading and final stabilization.
- Conditions Where Practice Applies** This practice is applicable where travel ways are needed in a planned land use area or wherever stone-base roads or parking areas are constructed, whether permanent or temporary, for use by construction traffic.
- Planning Considerations** Improperly planned and maintained construction roads can become a continual erosion problem. Excess runoff from roads causes erosion in adjacent areas and an unstabilized road may become a dust problem. Construction vehicle routes are especially susceptible to erosion because they become compacted, and collect and convey runoff water along their surfaces. Rills, gullies, and troublesome muddy areas form unless the road is stabilized.
- During wet weather unstabilized dirt roads may become so muddy they are virtually unusable, generating sediment and causing work interruption. Proper grading and stabilization of construction routes often saves money for the contractor by improving the overall efficiency of the construction operation while reducing the erosion problem.
- Situate construction roads to reduce erosion potential, following the natural contour of slopes, wet or rocky areas, and highly erosive soils.
- Controlling surface runoff from the road surface and adjoining areas is a key erosion control consideration. Generally locate construction roads in areas where seasonally high water tables are deeper than 18 inches. Otherwise, subsurface drainage may be necessary.

When practical, install permanent paved roads and parking areas and use them for construction traffic early during the construction operation to minimize site disruption.

**Design Criteria Location:** Temporary roads should be located to serve the purpose intended; facilitate the control and disposal of water; control or reduce erosion; and make the best use of topographic features. Temporary parking areas should be located on naturally flat areas to minimize grading.

Temporary roads should follow the contour of the natural terrain to minimize disturbance of drainage patterns. If a temporary road must cross a stream, the crossing must be designed, installed, and maintained according to specification.

**All stream crossings require authorization from the Tennessee Division of Water Pollution Control and United States Army Corps of Engineers prior to construction. For more information, see Appendix C of CGB and:**

<http://www.state.tn.us/environment/permits/arap.htm>

**Grade and Alignment:** The gradient and vertical and horizontal alignment should be adapted to the intensity of use, mode of travel, and level of development. Grades for temporary roads should not exceed ten percent except for very short lengths (200 feet or less), but maximum grades of 20 percent or more may be used if necessary for special uses. Frequent grade changes generally cause fewer erosion problems than long continuous gradients. Grades for temporary parking areas should be sufficient to provide drainage but should not exceed four percent.

Curves and switchbacks must be of sufficient radius for trucks and other large vehicles to negotiate easily. On temporary roads, the radius should be no less than 35 feet for standard vehicles and 50 feet for tractor trailers.

**Width:** Temporary roadbeds should be at least 14 feet wide for one-way traffic and 20 feet wide for two-way traffic. The width for two-way traffic should be increased approximately four feet for trailer traffic. A minimum shoulder width should be two feet on each side. Where turnouts are used, road width should be increased to a minimum of 20 feet for a distance of 30 feet.

**Side Slopes:** All cuts and/or fills should have side slopes designed to be stable for the particular site conditions and soil materials involved. All cuts and/or fills should be 2:1 or less, to the extent possible. When maintenance by machine mowing is planned, side slopes should be no steeper than 3:1.

**Drainage:** The type of drainage structure used will depend on the type of activity and runoff conditions. The capacity and design should be consistent with sound engineering principles and should be adequate for the class of vehicle, type of road, development, or use. Structures should be designed to withstand flows from a 25-year, 24-hour frequency storm. Ditches should be designed to be on stable grades and/or protected with structures or linings for stability.

**Stabilization:** A 6-inch layer of coarse aggregate, such as TDOT #57, should be applied immediately after grading or the completion of utility installation within the right-of-way. In areas experiencing heavy traffic, stone should be placed at an 8 to 10 inch depth to avoid excessive dissipation or maintenance needs.

**Geotextile:** Geotextile should be applied beneath the stone for additional stability.

All roadside ditches, cuts, fills, and disturbed areas adjacent to parking areas and roads should be stabilized with appropriate temporary or permanent seeding or with rock armoring.

### **Permanent Roads and Parking Areas**

Permanent roads and parking areas should be designed and constructed according to criteria established by the local authority and TDOT. Permanent roads and parking areas should be stabilized in accordance with this specification, applying an initial base course of gravel immediately following grading.

### **Construction Specifications**

- Trees, stumps, brush, roots, weeds, and other objectionable material should be removed from the work area.
- Unsuitable material should be removed from the roadbed and parking areas.
- Ensure that road construction follows the natural contours of the terrain if possible.
- Locate parking areas on naturally flat areas, if they are available. Keep grades sufficient for drainage, but generally not more than 2 to 3 percent.
- Grading, subgrade preparation, and compaction should be done as needed. Fill material should be deposited in layers not to exceed 9 inches and compacted with the controlled movement of compacting and earth moving equipment.
- Provide surface drainage, and divert excess runoff to stable areas by using water bars or turnouts.
- Keep cuts and fills at 2:1 or flatter for safety and stability and to facilitate the establishment of vegetation and maintenance.
- Spread, at minimum, a 6 inch course of TDOT #57 stone evenly over the full width of the road and smooth to avoid depressions.
- Where seepage areas or seasonally wet areas must be crossed, install subsurface drains or geotextiles fabric cloth before placing the crushed stone.
- Vegetate all roadside ditches, cuts, and fills, and other disturbed areas or otherwise appropriate stabilization as soon as grading is complete.
- Structures such as culverts, pipe drops, or bridges should be installed to the lines and grades shown on the plans or as staked in the field. Culverts should be placed on a firm foundation. Selected backfill material should be placed around the culvert in layers not to exceed 6 inches. Each layer should be properly compacted.



**Maintenance  
and Inspection  
Points**

Add top dressing of stone to roads and parking areas to maintain a gravel depth of 6 inches.

Remove any silt or other debris causing clogging of roadside ditches or other drainage structures.

Treat sediment-producing areas immediately.

**References**

*TN Department of Transportation*

*North Carolina Erosion and Sediment Control Planning and Design Manual*

## SEDIMENT CONTROL PRACTICES

### 7.37 TUBES AND WATTLES

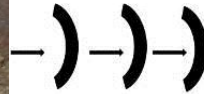

TUBES, WATTLES, SOCKS

- Definition** A small temporary sediment barrier constructed to intercept sheet flow. In this application, wattles and tubes are primarily sediment control measures. Section 7.25 discusses wattles as erosion control measures used in concentrated flow applications.
- Purpose** To interrupt flow, decrease velocities, pond water and allow runoff-produced sediment to settle out behind barrier.
- Conditions Where Practice Applies** This practice is applicable along or on the ground contour or at the toe of slopes and aids in sediment retention. While they are generally used at regular intervals on a slope, they may also be placed at the top or toe of the slope, or at breaks in grade. In addition, they may be placed on or around the perimeter of soil stockpiles or around catch basin inlets.
- Planning Considerations** The stability of tubes, wattles, and socks are very dependent upon proper staking. Thus, they may not be utilized on pavement, rocky soil or at any location where the stakes cannot be driven to the required depth.
- Design Criteria** When applied on slopes, temporary sediment tubes should be placed along the contour, and the ends of the tubes should be turned upslope in order to prevent erosion which could occur as flow bypasses around the ends of the row. This will force the discharge to overtop the row away from the end points. The spacing between rows of tubes should be based on Table 7.37-1. The maximum drainage area to a wattle is  $\frac{1}{4}$  acre per 100 linear feet of wattle.

**Table 7.37-1 Wattle and Tube Spacing Table for Slope Application**

Slope	Wattle and Tube Diameter				
	8"	12"	18"	20"	24"
2%	70'	100'	N/A	N/A	N/A
5%	30'	60'	100'	100'	100'
10%	20'	30'	70'	85'	100'
6:1	N/A	20'	40'	50'	55'
4:1	N/A	20'	30'	30'	30'
3:1	N/A	N/A	20'	20'	25'
2:1	N/A	N/A	20'	20'	20'

The size of a sediment tube for a slope application should be selected based on the gradient and length of the slope. In general, larger tube diameters should be selected for steeper or longer slopes.

Where long rows are required on a slope, the ends of the individual tube segments should be overlapped as shown on the standard drawing. This will ensure that gaps will not occur between individual tube segments, allowing sediment-laden water to escape the measure. Tube/wattle netting should be a knitted material with 1/8 to 3/8 inch openings and made of photodegradable (polypropylene, HDPE) or biodegradable (cotton, jute, coir) material.

### **Construction Specifications**

Proper site preparation is essential to ensure sediment wattles and tubes are in complete contact with the underlying soil or underlying surface. Remove all rocks, clods, vegetation or other obstructions so installed sediment tubes have direct contact with the underlying soil or surface.

Install tubes by laying them flat on the ground. Excavate a small trench 2-3 inches in depth on the contour and perpendicular to water flow. Soil from the excavation should be stored close by for use after the wattle has been installed.

Install tubes so no gaps exist between the soil and the bottom of the sediment tube. Lap the ends of adjacent sediment tubes a minimum of 6-inches to prevent flow and sediment from passing through the field joint.

Wooden stakes should be used to fasten the wattles to the soil. When conditions warrant, a straight metal bar can be used to drive a "pilot hole" through the wattle and into the soil.

Drive wooden stakes through the wattle and angled slightly against the direction of flow (see figure 7.37-1). Install wooden stakes at 4 feet intervals, unless the wattle manufacturer specifies otherwise, leaving less than 1-2 inches of stake exposed above the wattle. Alternately, stakes may be placed on each side of the wattle tying across with a natural fiber twine or staking in a crossing manner ensuring direct soil contact at all times.

Terminal ends of wattles may be dog legged up slope to ensure containment and prevent channeling of sedimentation.

Backfill the upslope length of the wattle with the excavated soil and compact.

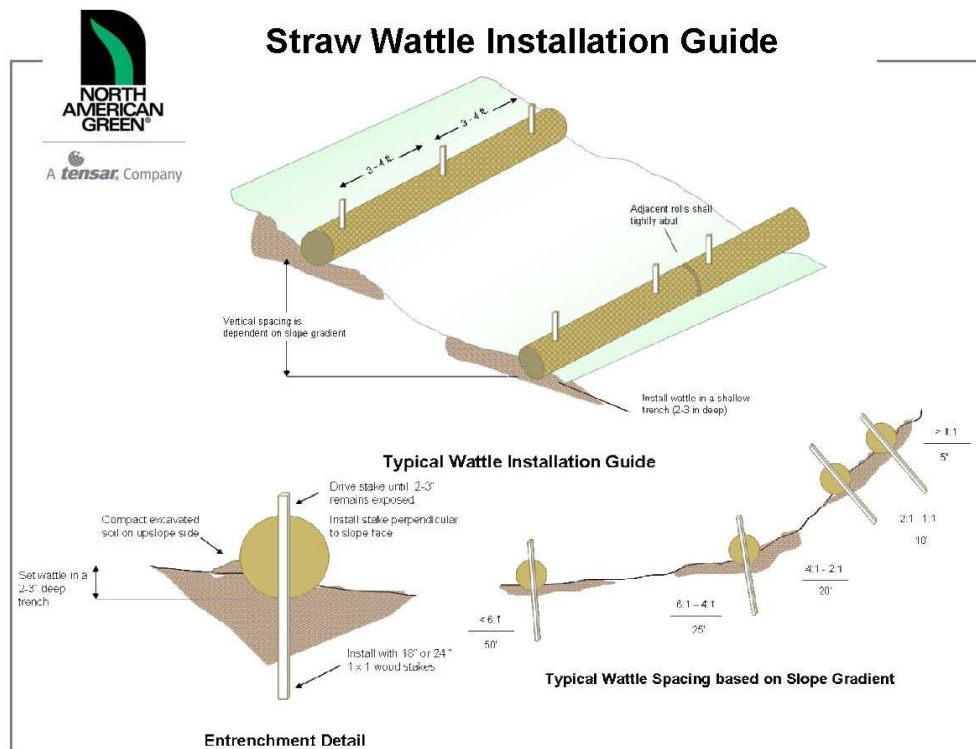

Figure 7.37-1 Wattle Stake Installation

Care shall be taken during installation so as to avoid damage occurring to the wattle as a result of the installation process. Should the wattle be damaged during installation, a wooden stake shall be placed either side of the damaged area terminating the log segment.

### Maintenance and Inspection Points

Inspect wattles and tubes after installation for gaps under and between the joints of adjacent ends of wattles and tubes.

Repair all rills, gullies, and undercutting near wattles and tubes.

Remove all sediment deposits that impair the filtration capability of the tubes when the sediment reaches 1/3 the height of the exposed tube.

Remove and/or replace installed sediment tubes as required to adapt to changing construction site conditions.

Prior to final stabilization, backfill all trenches, depressions and other ground disturbances caused by the removal of the devices.

### References

*TDOT Design Division Drainage Manual*

*TDOT Erosion Control Standard Drawing EC-STR-31*

*South Carolina DHEC Stormwater Management BMP Handbook*

*US Department of Transportation Federal Highway Administration, Western Federal Lands Highway Division, Sediment Wattle Detail WM157-20*

*Earth Savers, <http://www.earth-savers.com/>*

## SEDIMENT CONTROL PRACTICES

### 7.38 FILTER BERM



— F Berm — F Berm — F Berm —

FILTER BERM

**Definition** Filter berms are a linear sediment trapping measure composed either of wood chips (mulch) or a 50/50 combination of wood chips and compost material.

**Purpose** To reduce runoff flow velocities so that eroded sediments can be settled upstream of the filter, and to act as a filter as runoff passes through the materials in the berm.

**Conditions Where Practice Applies** Filter berms may be applied on any slope along the contour where runoff can be expected to be in the form of sheet flow. Usually, this will be on slopes less than 300 feet in length or at the toe of a given slope. Filter berms may also be used where silt fence would not be feasible due to exposed rock or other conditions which would prevent the fence from being trenched in.

However, care should be taken in locating filter berms, as mulch material is easily floated away in runoff. Mulch berms are most appropriate treating very small drainage areas.

**Planning Considerations** This measure consists of un-compacted buoyant materials and tends to be moved by concentrated flows. Thus, filter berms should be used only where sheet flow conditions are expected. They cannot treat flows in gullies, ditches, or channels. Mulch berms may require the addition of structural components, such as silt fence or wattles, to prevent movement of mulch.

**Design Criteria** Detailed design of this measure is not required; however, when filter berms are specified, the following standards should be used.

- Compost is a manufactured product which should be acquired from an approved supplier. Thus, the cost of bringing this material to the job site may be a factor at some locations. Wood chips, on the other hand, can be produced on-site as a byproduct of site clearing activities. The choice of

measure (mulch berm, compost berm, etc.) to be applied at a given site should be based on the availability and relative costs of the required materials.

- The filter berm shall be at least 1.5' in height and 3' wide at the base.

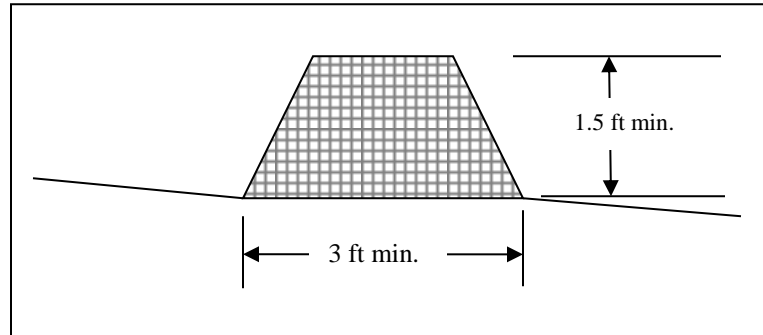

**Figure 7.38-1 Filter Berm Dimensions**

- The drainage area upstream of a filter berm should be less than  $\frac{1}{4}$  acre per 100 linear feet of berm. On long slopes where this limit would be exceeded, structural components, such as silt fence and wattles, should be installed on the upgradient side of the filter berm. The fence or wattle will prevent excessive hydraulic forces from displacing the material in the berm, while the filter berm provides increased filtration of runoff passing through the fence.

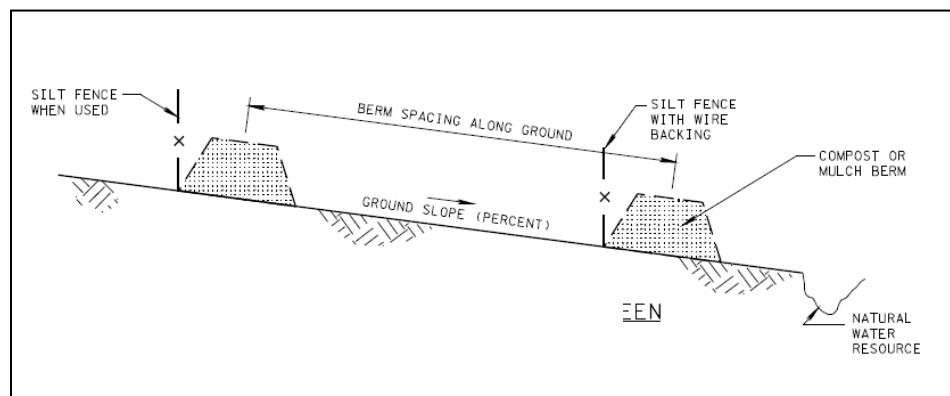

**Figure 7.38-2 Mulch Berm with Silt Fence with Backing**

- Both ends of a run of filter berm should be turned up-slope to a point where the base of the berm at the terminus points will be higher than the top of the berm anywhere along the contour.
- The material used to construct a filter berm should be well-graded. Usually, the particles in a berm will range in size from  $\frac{1}{4}$  inch to 6 inches in length. The smaller particles serve to increase the effectiveness of the measure as a filter while the larger particles help to increase its stability under the pressure exerted by the runoff.



**Construction Specifications**

- Filter berms should be trapezoidal in shape and installed along the contour by means of pneumatic blowers or by other suitable equipment. It is important that a berm be placed along the ground contour as they will be sensitive to failure due to concentration of flows. Runoff must be intercepted on the contour to insure that sheet flow is not converted into concentrated flow. When placed at the base of a slope, the berm should be located at least 10 feet away from the toe in order to provide an area for the storage of sediments. As a general rule, steeper slopes would require a larger berm size. In addition, the bottom width of a berm should be about twice its height.
- The material in a mulch filter berm usually will not support vegetation; therefore, these berms should not be seeded with either temporary or permanent seed. A compost filter berm will support vegetation if the material is properly graded and the portion of compost is 65% or less. Compost materials with greater percentages of organic matter usually contain more nutrients than required by the seeded grasses.
- A compost filter berm which has been seeded can be left in place as a permanent feature as long as the structure is stable against erosion and movement from water.

**Maintenance and Inspection Points**

Routinely inspect filter berms and maintain to a functional condition throughout construction. Install additional filter material if necessary. Upon project completion, disperse or remove the berm.

Remove sediment from behind the filter berm when it has accumulated to  $\frac{1}{2}$  the original height of the structure.

**References**

*TDOT Design Division Drainage Manual*

*TDOT Erosion Control Standard Drawing EC-STR-35*

## SEDIMENT CONTROL DEVICES

### 7.39 TURBIDITY CURTAIN

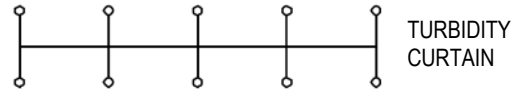

**Definition** An in-stream sediment control measure designed to trap or filter sediment without halting the movement of the water itself. This device consists of a filter fabric curtain suspended from floats and held vertically in the water by means of a bottom ballast chain.

**Purpose** To provide an isolated work zone where sediments generated by the project can settle. In this way, it prevents the migration of these sediments into the larger remaining water body.

**Conditions Where Practice Applies** Floating turbidity curtains may be applied adjacent to the shoreline of a river or lake to contain sediments which may be carried into the water by construction site runoff. They should be considered only where adequate or conventional on-shore sediment control measures are not feasible or possible. They may also be used to surround a work site within the channel of a river (i.e. bridge pier construction, dredging or filling) or within a larger water body in order to prevent worksite sediments from being dispersed.

**Planning Considerations** Any work in a stream, river or lake requires approval by TDEC and the Corps of Engineers. To minimize the impact to the resource, the in-stream construction period should be minimized and should be conducted during periods of low flow.

- Turbidity curtains should not be applied where the anticipated flow velocities will exceed 5 ft/sec. In addition, turbidity curtains are not designed as prefabricated dams; and therefore, should not be used across flowing streams.
- In ponds and lakes, large changes in stage can cause the curtain to become submerged or to be damaged. This measure is best applied in situations or during periods of time when anticipated changes in the water surface elevation will be minimal. Also, wave action from boats or wind can significantly reduce the effectiveness of a floating turbidity curtain.

**Design Criteria** A floating turbidity curtain consists of a geotextile filter cloth with sufficient permeability to allow flow to pass through while retaining sediments. The cloth is suspended from floats which are anchored into place to maintain the shape and location of the barrier. A ballast chain is included in a pocket at the bottom of the curtain to help hold the cloth in a vertical position and to provide tensile strength when the material is stressed.

The curtain is formed by joining segments of geotextile fabric which are 50 to 100 feet long, and an anchor (consisting of two weights, cables and floats) should be placed at each joint in the fabric. Additional anchors may be utilized, depending upon the anticipated flow velocities or wave action, based on manufacturer recommendations. At a minimum, each end of the curtain should be provided with an on-shore anchor and two anchors would be required in the water.

The designer should consider the morphology of the river in evaluating the anticipated flow velocities at a proposed turbidity curtain site. Where a river runs a straight course, flow velocities adjacent to shore are usually much lower than the velocities in the center of the channel. On the other hand, flow velocities can be very high on the outside of a bend in the river. The measure should not be applied where the anticipated flow velocities will exceed 5 ft/sec.

Proper consideration should be given to safety measures at locations where boat traffic may be present. Usually, this is addressed by providing floats with a bright yellow or orange color and by providing lighted marker buoys for night time use. The Corps of Engineers, TVA, or other regulating agency may require the use of lighted buoys on navigable waterways.

**Construction Specifications** The floating turbidity curtain **must not** be installed perpendicular across the main flow of a significant body of moving water.

When applied in a river, a floating turbidity curtain should be installed parallel to the shore such that it would not intercept the main force of the current.

The turbidity curtain must be anchored to prevent drift shoreward or downstream. Anchorage should be installed on both shore and stream side. The curtain should be located as close as possible to the project, while allowing sufficient room for any equipment which must work in or near the water.

The bottom of the curtain should be approximately 12 inches above the bottom of the lake or river to prevent the bottom of the curtain from being buried by retained sediments, and in turn, reduce the quantity of sediment released into the water when the curtain is removed.

In situations where significant wave action is anticipated, either as the result of wind or boat traffic, the depth of the curtain should be no greater than 12 feet. This will prevent stresses in the fabric from becoming excessive as it billows with the force of the waves.

In shallow water (2 feet in depth or less) a turbidity curtain may be installed on stakes driven into the bed of the water body.

When installed in a navigable waterway, buoys should be lit according to regulatory agency standards.

**Maintenance and Inspection Points** Maintain a 12 inch minimum gap between the skirt bottom and channel bottom to prevent accumulated sediment from pulling the top of the curtain below the water surface.

The turbidity curtain and adjacent work areas should not be disturbed 12 hours prior to removal of the curtain from the water body. Maintenance should be performed as needed. The curtain should be removed upon completion of the work in a manner that will prevent siltation of the waterway. During removal extreme care should be taken to not disturb any sediment deposits.

**References** *TDOT Design Division Drainage Manual*  
*TDOT Erosion Control Standard Drawing EC-STR-38*

**SEDIMENT CONTROL PRACTICES****7.40 FLOCCULANTS**

FLOCCULANT

**Definition** Flocculation is the chemical process of causing small, suspended soil particles to stick to each other to form “flocs”. These flocs more readily settle out compared to the individual particles.

**Purpose** To promote the formation of flocculants in an effort to treat storm water so that suspended clays and fine silts will settle out of the water quickly before leaving the construction site. To reduce the time required to settle out smaller soil particle sizes.

**Conditions Where Practice Applies** This temporary application is not intended for application to surface waters of the state. It is intended for application on construction sites where construction stormwater feeds into pre-constructed sediment ponds, basins or other settling areas.

Water discharged from sediment control measures can have high concentrations of suspended clays and fine silts that are very difficult to settle out. There are three ways to reduce suspended sediment: (1) store the runoff long enough for the materials to settle, (2) store and filter runoff, or (3) treat water with chemical flocculants. Filtering water can be high maintenance and expensive. The most practical and least expensive option for most situations is flocculation. Flocculants should be used to prevent damage to water resources. However, sediment at each site has to be evaluated individually for responsiveness to flocculants, as flocculant use is very soil-type dependent and requires a screening process to determine the best chemical for each specific location.

**Planning Considerations** PAM is a term describing a wide variety of chemicals based on the acrylamide unit. When linked in long chains, a portion of the acrylamide units can be modified to result in a net positive, neutral, or negative charge on the PAM molecule. The positively charged (cationic) PAMs are not widely used because they can be toxic to fish and other aquatic organisms if they enter water bodies in sufficient concentrations. **Cationic PAMs are not allowed in TN.**

The negatively charged (anionic) PAMs are much less toxic to aquatic organisms and are widely used in furrow irrigation agriculture. This is the type of PAM which is commonly allowed for use in stormwater treatment. Anionic PAM is available in emulsions, powders, gel bars and logs. Other management practices must be used in combination with anionic PAM.

When including PAM as a treatment option on a project, the following items must be addressed:

- All PAM applications require prior review by TDEC.
- Areas where PAM has been applied must drain to a sediment basin or trap for final settling and polishing prior to discharging from the site.
- Adequate mixing is necessary for PAM to be fully effective. Passive treatment using the turbulent flow of water in a channel or at the outlet of a pipe as the mixing method is encouraged.
- PAM effectiveness decreases with exposure rain events. Reapplication is likely necessary after 2 storm events.
- PAM is water soluble, but it dissolves slowly and requires considerable agitation and time to dissolve.
- Soil tests are required to ensure that the PAM is matched with the soil.
- Follow the manufacturer's application or dosage rates and application instructions for site sediment conditions.

**Design Criteria** PAMs mixed with water having high suspended solid loads can greatly reduce turbidity and suspended solid concentrations. It may be used in a dewatering operation discharge from borrow pits or construction excavations, from discharged settling ponds, or from stormwater from land disturbance. It is critical that an application system be in place that minimizes the chances of malfunctions that could result in over-application of PAMs and subsequent adverse effects to aquatic life. It is especially important to be cautious near sensitive streams, such as those classified as exceptional or outstanding national resource waters.

In using any form of PAM, several basic guidelines shall be followed:

1. Only use PAM after all appropriate physical BMP's have been implemented at a particular site.
2. PAMs shall not be applied directly to streams, wetlands and other waters of the state.
3. A sediment basin or similar structure between the application point of PAMs and surface waters is required. PAM cannot be applied downgradient from the sediment basin or sediment trap.



4. Choose the appropriate PAM for the soil type.
5. Ensure PAM emulsions and powders are of the **anionic type only** and meet the following requirements:
  - a. Meets the EPA and FDA acrylamide monomer limits of equal to or greater than 0.05% acrylamide monomer.
  - b. Has a density of 10% to 55% by weight and a molecular weight of 16 to 24 Mg/mole.
  - c. Mixture is non-combustible.
  - d. Contains only manufacturer-recommended additives.
6. PAM shall be mixed and/or applied in accordance with all Occupational Safety and Health Administration (OSHA) Material Safety Data Sheet (MSDS) requirements and the manufacturer's recommendations for the specified use conforming to all federal, state and local laws, rules and regulations.
7. All vendors and suppliers of PAM, PAM mix or blends shall present or supply a written toxicity report which verifies that the PAM, PAM mix or blend exhibits acceptable toxicity parameters which meet or exceed the EPA requirements for the state and federal water quality standards. Whole effluent testing does not meet this requirement as primary reactions have occurred and toxic potentials have been reduced. This document shall be a component of the field SWPPP.
8. Cationic forms of PAM are not allowed for use due to their high levels of toxicity to aquatic organisms. Emulsions shall never be applied directly to streams or wetlands due to surfactant toxicity.
9. Emulsion batches shall be mixed following recommendations of a testing laboratory that determines the proper product and rate to meet site requirements. Application method shall insure uniform coverage to the target area.
10. Dry form (powder) may be applied by hand spreader or a mechanical spreader. Mixing with dry silica sand will aid in spreading. Pre-mixing of dry form PAM into fertilizer, seed or other soil amendments is allowable. Application method shall ensure uniform coverage to the target area.
11. Block or log forms shall be applied following site testing results to ensure proper placement and performance and shall meet or exceed state and federal water quality requirements. Place anionic gel logs upstream from the inlet to ponds and traps on-site, or other locations where flow and mixing are optimal. Logs or blocks must be installed upgradient from the sediment basin or trap.
12. PAM application must occur upstream such that at least 60 seconds of mixing time occurs prior to discharging to a sediment basin or trap.

**Construction Specifications**

One of the key factors in making a flocculant work is to ensure that it is dissolved and thoroughly mixed with the runoff water, which can be accomplished in several ways. Introducing the PAM to the runoff at a point of high velocity will help to provide the turbulence and mixing needed to maximize the suspended sediment exposure to the large PAM molecules. Examples include a storm drain junction box where a pipe is dropping water, inside a slope drain, or other areas of falling or fast moving water upslope from a sediment trap or basin.

Another option for introducing PAM into runoff involves running the water over a solid form of PAM. Powders can be sprinkled on various materials, such as jute, coir, or other geotextiles. When wet, PAM granules become very sticky, and bind to the geotextile fabric. The product binds to the material, and resists removal by flowing water rendering it ineffective for turbidity control. PAM' may also be purchased as solid blocks or logs. The logs are designed to be placed in flowing water to dissolve the PAM from the log somewhat proportionately to flow. While using these solid forms of PAM does not have the same challenges as liquid forms, they do have drawbacks. The amount of PAM released is not adjustable and is generally unknown, so the user has to adjust the system by moving or adding logs to get the desired effect. Because the PAM is sticky when wet, it can accumulate materials from the runoff and become coated, releasing little PAM. The solid forms also tend to harden when allowed to dry. This causes less PAM to be released initially during the next storm until the log becomes moist again.

To avoid these problems, the user must do two things to ensure PAM releases from the solid form:

- Reduce sediment load in the runoff upstream of the PAM location. This avoids burying the PAM under accumulated sediment.
- Create constant flow across or onto the solid PAM. The flow will help dissolve and mix the PAM as well as prevent suspended solids from sticking to the PAM product.

Once the PAM is introduced into the runoff and thoroughly mixed, the runoff needs to be captured in a sediment trap or basin in order for the flocs to settle out. It is important that the inlet of this structure be stabilized with geotextile or stone to prevent gully erosion at the upper end of the basin. Such erosion can contribute significantly to the turbidity in the basin and overwhelm the treatments. Other modifications may also be useful such as installing baffles across the basin or dewatering from the surface using a skimmer or similar device.

**Maintenance and Inspection Points**

Dosing systems using pumps should be checked daily.

Floc logs should be checked at least once a week or after a rainfall event of ½" or greater to ensure the logs remain in place, are moist, and are not covered with sediment.

**References**

*North Carolina Erosion and Sediment Control Planning and Design Manual*

## STREAM PROTECTION PRACTICES

### 7.41 STREAM BUFFERS



- Definition** A stream buffer is a non-structural low impact development control in areas along a stream or wetland where disturbance is restricted or prohibited.
- Purpose** A stream buffer's primary function is to physically protect and separate a stream or wetland from future disturbance or encroachment. It is **not** a sediment control.
- Conditions Where Practice Applies** All construction sites containing and/or adjacent to receiving streams or waters are required to have stream buffers between the top of the stream bank and the disturbance.
- Planning Considerations** Effective stream buffers consist of undisturbed natural vegetation, including maintaining the original tree line along the stream or channel banks. Promptly stabilize disturbed buffers with a dense cover of strong rooted grasses, native plants and native trees.
- Construction related materials and equipment must be stored outside the buffer area.
- Other municipalities and counties may have more restrictive requirements for the width or maintenance of a stream buffer. The more restrictive stream buffer requirements shall apply.
- Design Criteria** For sites that contain and/or are adjacent to a receiving stream designated as impaired or Exceptional Tennessee waters a 60-foot natural riparian buffer zone adjacent to the receiving stream shall be preserved, to the maximum extent practicable, during construction activities at the site. The natural buffer zone should be established between the top of stream bank and the disturbed construction area. The 60-foot criterion for the width of the buffer zone can be established on an average width basis at a project, as long as the minimum width of the buffer zone is more than 30 feet at any measured location.

A 30-foot natural riparian buffer zone adjacent to all streams at the construction site shall be preserved, to the maximum extent practicable, during construction activities at the site. The riparian buffer zone should be preserved between the top of stream bank and the disturbed construction area. The 30-foot criterion for the width of the buffer zone can be established on an average width basis at a project, as long as the minimum width of the buffer zone is more than 15 feet at any measured location.

For optimal stormwater treatment, it is recommended that concentrated flow be converted into sheet flow through the use of a level spreader prior to discharging into the buffer. Concentrated flow can cause erosion in the buffer.

**Construction Specifications**

Install controls along the outer upstream edge of the stream buffer to prevent inadvertent disturbance to the buffer. Consider high visibility controls, such as fencing.

Where a stream crossing is necessary, comply with the conditions of the Aquatic Resource Alteration Permit for the amount of stream buffer that can be disturbed.

Ensure that sediment controls are installed upgradient from the buffer to protect it from sediment-laden runoff.

Install level spreaders to convert concentrated flow into sheet flow prior to discharging across the buffer.

If a buffer is disturbed, the buffer should be restored as follows:

1. All areas of the buffer being restored must be planted with native or natural vegetation that is appropriate to achieve a stable stream protection corridor, including tree canopy.
2. All areas of the buffer being restored must be stabilized against erosion.
3. During restoration activities, erosion prevention and sediment control measures must be installed to protect the stream. These measures can include turf reinforcement mats, erosion control blankets, wattles, etc., to stabilize the area in the short- and long-term.
4. To increase the chances for the success and health of the buffer, the plant species, density, placement, and diversity in the buffer restoration plan must be appropriate for stream buffers. Proposed planting and long-term maintenance practices must also be appropriate and properly performed.
5. Vegetation mortality must be included in the planting densities in buffer restoration plans.

More detailed information on streambank and buffer restoration techniques, planting guidelines and native plant species can be found from the following sources:

- Tennessee Valley Authority's Riparian Restoration webpage, located at [www.tva.com/river/landandshore/stabilization/index.htm](http://www.tva.com/river/landandshore/stabilization/index.htm)

- Tennessee Valley Authority's Native Plant Finder webpage, located at [www.tva.com/river/landandshore/stabilization/plantsearch.htm](http://www.tva.com/river/landandshore/stabilization/plantsearch.htm);
- Banks and Buffers: A guide to selecting native plants for streambanks and shorelines. Contact information to obtain this publication is provided at [www.tva.com/river/landandshore/stabilization/websites.htm](http://www.tva.com/river/landandshore/stabilization/websites.htm);
- The Tennessee Native Plant Society at [www.tnps.org](http://www.tnps.org)
- The Tennessee Exotic Plant Pest Council website, located at [www.tneppc.org](http://www.tneppc.org); and
- The Natural Resource Conservation Service (NRCS).

**Maintenance  
and Inspection  
Points**

Inspections must focus on stability of the buffer. No disturbance of the buffer is allowed unless accounted for in the overall plan and a minimum average buffer width is provided, as noted above.

During inspections, ensure that buffer boundaries are well defined and clearly marked.

Where erosion in the buffer is identified, measures shall be taken to halt the erosion and repair the buffer.

Where the buffer is disturbed, a buffer restoration plan shall be developed and included in the SWPPP.

**References**

*South Carolina DHEC Storm Water Management BMP Handbook*

*North Carolina Sediment and Erosion Control Planning and Design Manual*

*Knox County Stormwater Manual*

## STREAM PROTECTION PRACTICES

### 7.42 STREAM DIVERSION



**Definition** A stream diversion is a temporary diversion constructed to convey stream flow around in-stream construction.

**Purpose** Stream diversion channels are required by Aquatic Resource Alteration Permits in order to perform in-stream work separate from flowing water.

**Conditions Where Practice Applies** Construction often includes stream crossings thus creating a potential for excessive sediment loss into the stream, by both the disturbance and approach areas, and by work within the streambed and banks.

Stream diversions separate the flowing stream from the active construction area, reducing the potential for impacts from the instream construction activity.

**Planning Considerations** Disturbance within the confines of stream banks are required to be conducted “in the dry” or separate from flowing water. No excavation equipment should ever be operated in flowing waters.

In cases where in-stream work is unavoidable, a stream diversion should be considered to prevent excessive damage from sedimentation. To limit land-disturbance, overland pumping of the stream should be considered in low-flow conditions whenever possible.

Temporary pipes can also convey smaller stream flows.

Some streams are too large to construct a diversion channel of pipe. In those cases, consider the use of alternative structures, such as cofferdams and geotextile tubes, in order for work to be conducted in dry conditions.

There may be certain times of the year, especially in the summer, when rip rap or fabric-lined diversion channels may cause thermal pollution.



The duration of the instream work should be minimized to the shortest period possible. Clearing of the streambed and banks should be kept to a minimum.

Work that requires a stream diversion channel requires authorization from the Tennessee Division of Water Pollution Control and United States Army Corps of Engineers. All conditions of the ARAP and COE permit must be followed.

**Design  
Criteria**

Professionals familiar with the design of water conveyance systems should prepare construction plans and drawings for this technique. Several methods of diverting a stream are detailed below. There may be certain seasonal components to consider when attempting flow diversion of a stream, such as spawning times of individual fish species. Several other methods can be used to temporarily divert stream flows around an active work area. Regardless of the type of stream diversion chosen, the capacity of the diversion shall be designed to be equivalent to the bankfull capacity of the existing channel.

**Bypass Pumping**

A bypass pump and an impervious dike divert the flow of the watercourse from the inlet of the pipe to the outlet of the pipe (Figure 7.42-1). This is a water-to-water operation and care should be taken that the discharge is at a low flow rate to minimize turbidity and/or potential erosion of the stream channel at the outlet of the bypass pipe or hose. Use this practice when another type of diversion is not physically possible or practical or when the construction activities will not require pumping for an extended period. Do not use this practice when the discharge location cannot be adequately stabilized; when ponding of the stream to adequately submerge the pump suction line is not allowed or not practical; or when the normal flow of the stream cannot be handled by the typical bypass pump.

**Suspended Bypass Pipe**

The suspended bypass pipe is used where an existing pipe or culvert is extended. This bypass pipe is constructed inside the existing pipe or culvert to divert the watercourse through the work area while allowing the work area to remain dry (Figure 7.42-2). Use this practice when a pipe or culvert is being extended and is large enough to accommodate the bypass pipe or when space limitations do not allow for a fabric lined diversion channel (for example, widening grade and drain projects). Do not use this practice when the upstream ponding required to enter the suspended pipe inlet is unacceptable.

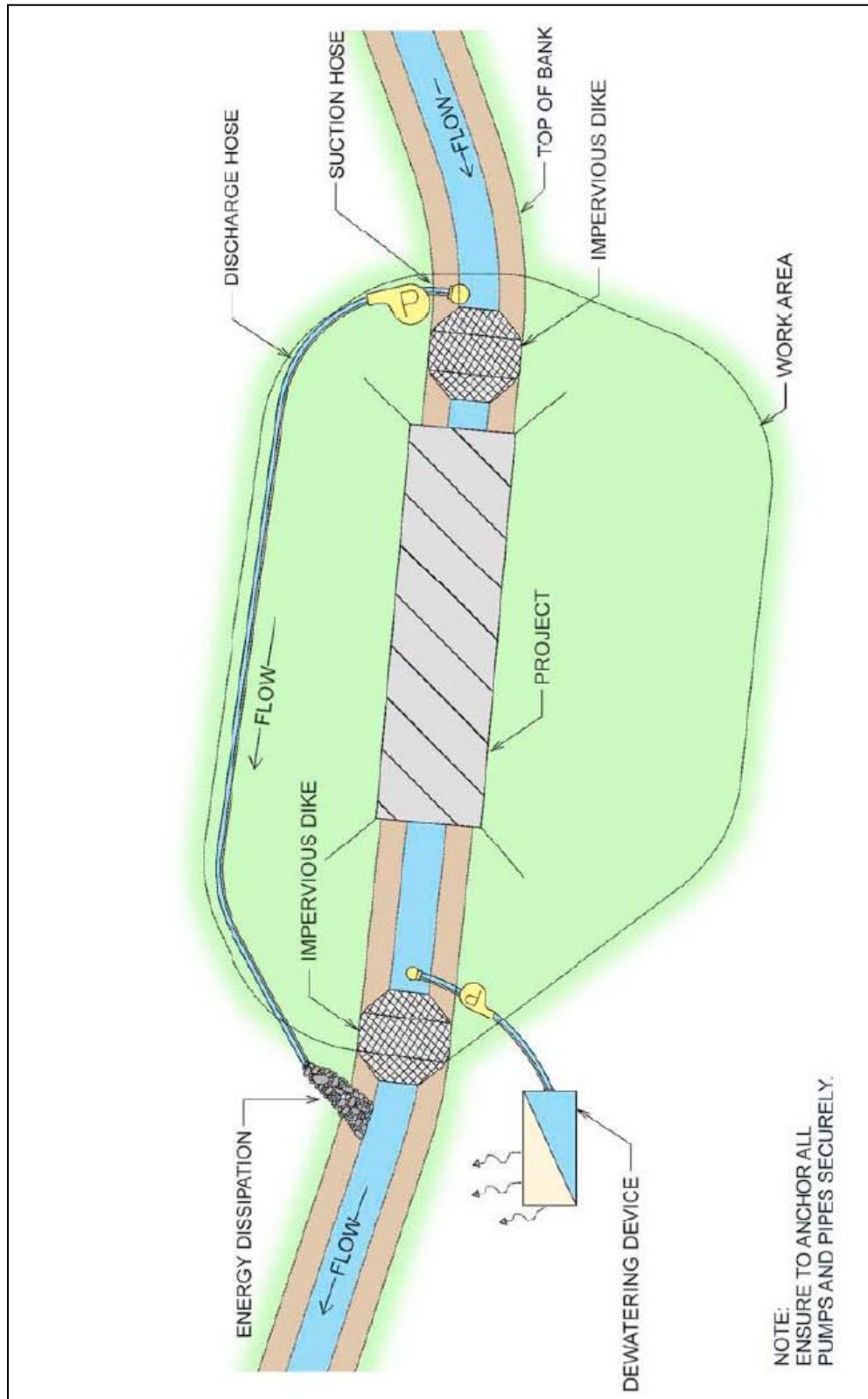

Figure 7.42-1 Stream Diversion Using Bypass Pumping (Source: NCDOT)

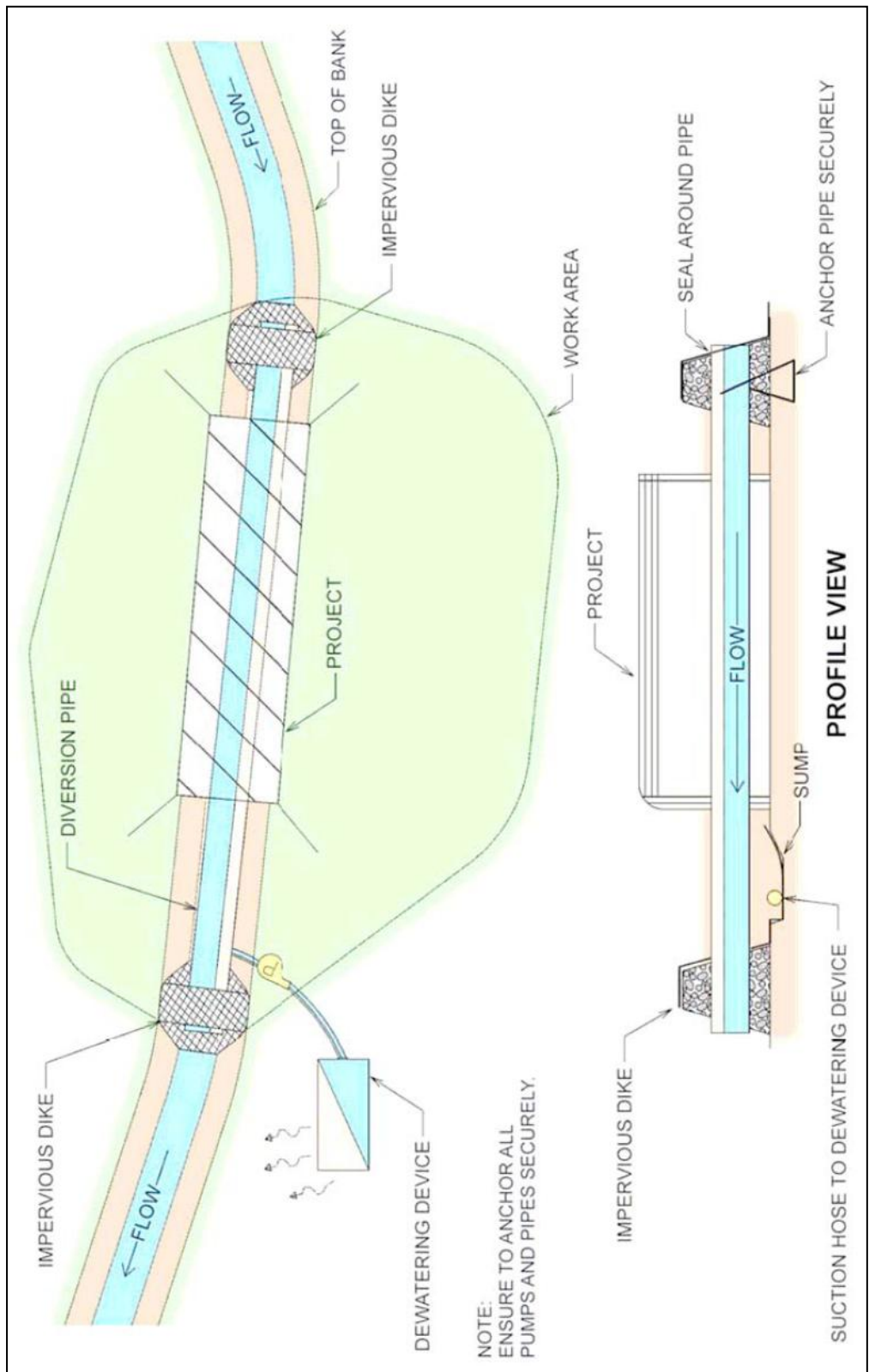

Figure 7.42-2 Stream Diversion Using Suspended Bypass Pipe (Source: NCDOT)

**Piped Diversion**

Install a temporary pipe to divert the flow of the watercourse around the work area without the use of pumping operations (Figure 7.42-3). While the cost is higher for this operation than an open plastic lined channel, the probability of offsite sediment loss is much lower than with an open diversion channel. Use this practice where adequate slope and space exist between the upstream and downstream ends of the diversion. Do not use this practice where adequate space is unavailable, such as at pipe extensions, headwall installations and some pipe/culvert replacements.

**Fabric Lined Diversion Channel**

A fabric lined temporary diversion channel is used to divert normal stream flow and small storm events around the work area without the use of pumping operations (Figure 7.42-4). The temporary diversion channel is typically constructed adjacent to the work area and is lined with a poly-fabric to minimize the potential for erosion within the temporary diversion channel. Use this practice where adequate space and slopes exist adjacent to the work area. Do not use this practice where adequate space is unavailable such as at pipe extensions, headwall installations and some pipe/culvert replacements.

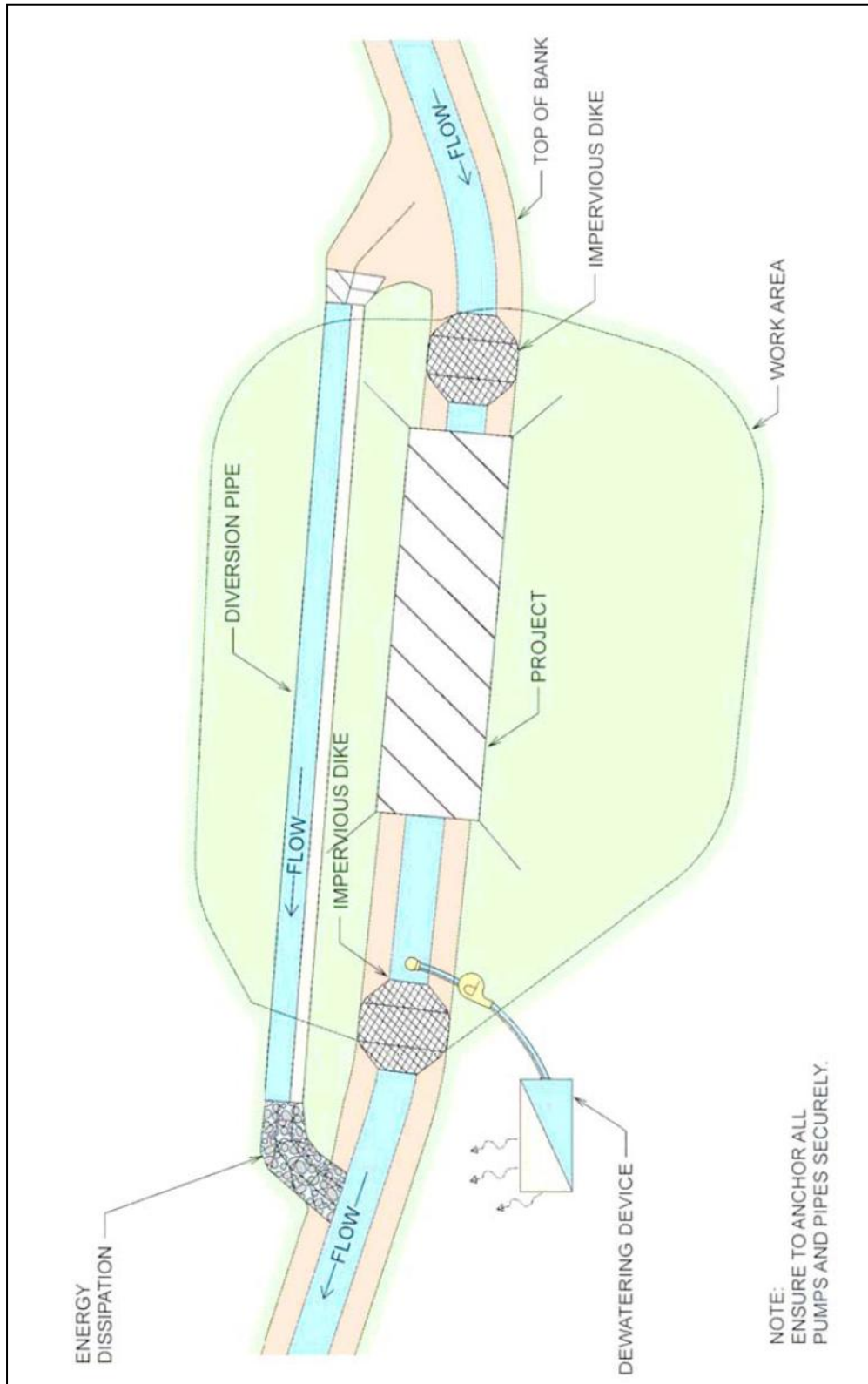

Figure 7.42-3 Stream Diversion Using Piped Diversion (Source: NCDOT)

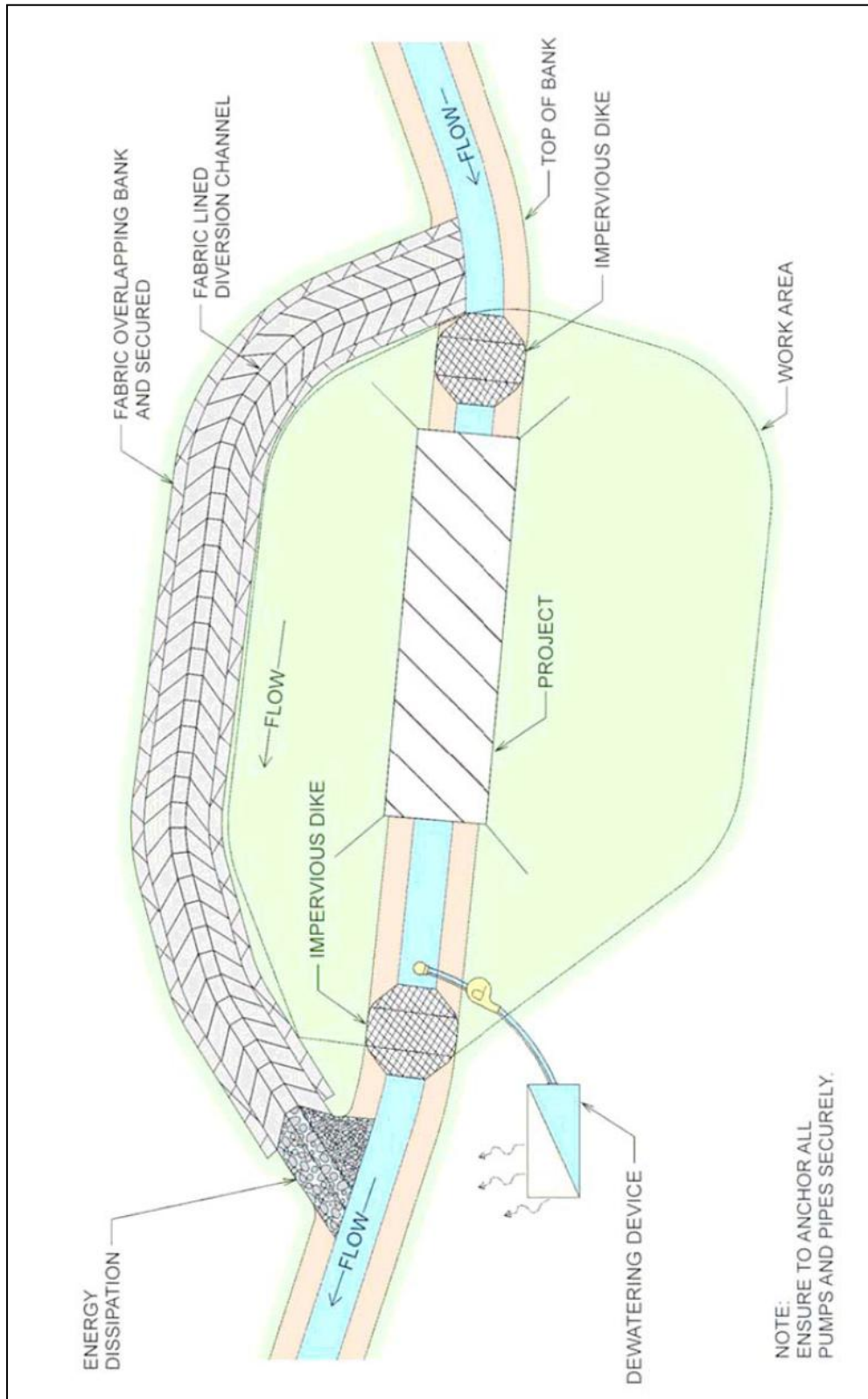

Figure 7.42-4 Stream Diversion Using Fabric Lined Channel (Source: NCDOT)



**Construction Specifications****General**

The impervious dikes used to divert normal stream flow or expected flow path around a construction site must be constructed of non-erodible material. Acceptable materials for impervious dikes include, but are not limited to, sheet piles, sandbags, and/or the placement of an acceptable size stone lined with polypropylene, or other impervious fabric. Prefabricated dams are also an option. Earthen material should not be used to construct an impervious dike when it is in direct contact with the stream. Dewatering devices include stilling basins and sediment filter bags.

**Bypass Pumping**

- Set up bypass pump and temporary piping. Place outlet of temporary pipe to minimize erosion at discharge site or provide temporary energy dissipation measures. Firmly anchor pump and piping.
- Construct outlet protection if needed.
- Construct impervious dike upstream of work area to impound water for bypass pump intake. Use a floating intake for pumps where possible.
- Construct an impervious dike downstream, if necessary, to isolate work area.
- Check operation of pump and piping system.
- Upon completion of construction, remove impervious dike, bypass pump, and temporary pipe and stabilize disturbed area.

**Suspended Bypass Pipe**

- Install sediment controls.
- Install temporary pipe through the existing pipe or culvert to be extended. Place outlet of temporary pipe to minimize erosion at discharge site or provide temporary energy dissipation measures.
- Construct an impervious dike upstream of the work area to divert flow through the temporary pipe. Anchor and seal temporary pipe securely at inlet.
- Construct an impervious dike at the downstream side of the bypass pipe to isolate work area.
- Upon completion of the culvert or pipe extension, remove the impervious dike and temporary pipe and stabilize disturbed area.

**Piped Diversion**

- Install sediment controls.
- Install temporary pipe adjacent to work area. Excavation may be required to provide a positive drainage slope from the upstream to downstream side.
- Connect the downstream temporary pipe into the downstream existing channel. Place outlet of pipe to minimize erosion at the discharge site or provide temporary energy dissipation measures.
- Connect the upstream temporary pipe into the upstream existing channel.
- Construct an impervious dike at the upstream side of the existing channel to divert the existing channel into the temporary pipe.
- Construct an impervious dike at the downstream side of the bypass pipe to isolate work area.

- Upon completion of construction, remove the impervious dike and temporary pipe and stabilize the disturbed area.

#### **Fabric Lined Diversion Channel**

- Install sediment controls.
- Excavate the diversion channel without disturbing the existing channel.
- Place poly-fabric liner in diversion channel with a minimum of 4 feet of material overlapping the channel banks. Secure the overlapped material using at least 1 foot of fill material.
- Connect the downstream diversion channel into the downstream existing channel and secure the poly-fabric liner at the connection.
- Connect the upstream diversion channel into the upstream existing channel and secure the poly fabric liner at the connection.
- Construct an impervious dike in the existing channel at the upstream side to divert the flow into the diversion channel.
- Construct an impervious dike in the existing channel at the downstream side to isolate the work area.
- Upon completion of the culvert construction, remove the impervious dikes and divert the channel back into the culvert.
- Remove the poly-fabric liner and fill in the diversion channel.
- Establish vegetation on fill section and all other bare areas.

#### **Maintenance and Inspection Points**

##### **Bypass Pump**

- Inspect bypass pump and temporary piping daily to ensure proper operation.
- Inspect impervious dike for leaks and repair any damage.
- Inspect discharge point for potential erosion.
- Ensure flow is adequately diverted through pipe

##### **Suspended Bypass Pipe**

- Inspect the inlet regularly and impervious dike for damage and/or leakage and to ensure flow is adequately diverted through pipe.
- Remove sediment and trash that accumulate behind the dike and at the inlet on a regular basis.
- Inspect the outlet regularly for potential erosion and to ensure flow is adequately diverted through the system.
- Ensure that the inlet is properly anchored and sealed.

##### **Piped Diversion**

- Inspect diversion berm and piping for damage.
- Remove accumulated sediment and debris from berm and inlet.
- Inspect outlet for potential erosion.

- Inspect for diverted flow that bypasses the temporary pipe and causes erosion as surface flow.

**Fabric Lined Diversion Channel**

- Check the poly-fabric liner for stability during normal flow.
- Check the liner for stability after each rainfall event.
- Do not allow earthen material to contact the water body.

The stream diversion channel should be inspected at the end of each day to make sure that the stream flow control measures and construction material are positioned securely. This will ensure that the work area stays dry and that no construction materials float downstream. Inspect impounded work area to ensure water is not contaminated with construction materials or chemicals and that dewatering/treatment is adequate. All repairs should be made immediately.

**References** *NCDOT Inspector Training*

*TDOT Environmental Division Mitigation Practices, Statewide Stormwater Management Plan*

## STREAM PROTECTION PRACTICES

### 7.43 TEMPORARY STREAM CROSSING

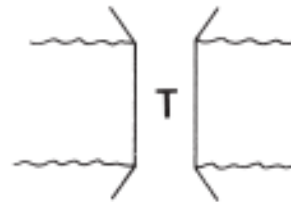

**Definition** A temporary stream crossing is a temporary structure installed across a flowing stream or watercourse for use by construction equipment.

**Purpose** This standard provides a means for construction vehicles to cross streams or watercourses without moving sediment into the stream, damaging the streambed or channel, or causing flooding.

**Conditions Where Practice Applies** Temporary stream crossings should be installed anywhere construction traffic cannot be routed around the stream but where the crossing will later be removed.

**Planning Considerations** All work in a stream must have prior approval from TDEC through the Aquatic Resource Alteration Permit (ARAP) process and all conditions of the ARAP must be followed. For more information, see:

<http://www.state.tn.us/environment/permits/arap.shtml>.

Structures may include bridges, round pipes, or pipe arches. Temporary stream crossings should be in place for less than one year and should not be accessible to the public.

**Design Criteria** Professional familiar with the hydraulic calculations necessary to accomplish the work should design stream crossing construction plans and drawings using sound engineering practices.

**Size:** The structure may be sized large enough to convey the bankfull flow of the stream, typically flows produced by a 2-year, 24-hour frequency storm, with normal high water protection since the flood plain will become effective at the bankfull elevation. However, if the crossing is designed as a low-water crossing, provision must be made for additional overflow protection of the structure, to prevent washout during high flow events.

**Location:** The temporary stream crossing should be perpendicular to the stream. Where approach conditions dictate, the crossing may vary up to 15° from the perpendicular.

**Overflow Protection:** Structures should be protected from washout during periods of peak discharges by diverting high flows around or over the structures. Methods to be considered for washout protection may include elevation of bridges above adjacent flood plain lands, crowning of fills over pipes or by the use of diversions, dikes or island type structures. Frequency and intended use, stream channel conditions, overflow areas, potential flood damage, and surface runoff control should be considered when selecting the type of temporary stream crossing to be used.

**Temporary Bridge Crossing:** A temporary access bridge causes the least erosion of the stream channel crossing when the bridge is installed and removed. It also provides the least obstruction to flow and fish migration. If the bridge is properly designed and appropriate materials are used, a temporary access bridge typically is long lasting and requires little maintenance. It may also be salvaged at project's end and used again in the future. However, a temporary bridge crossing is generally the most expensive crossing to design and construct. It also creates the greatest safety hazard if not adequately designed, installed and maintained.

**Temporary Culvert Crossing:** A temporary access culvert is the most common stream crossing. It can control erosion effectively, but can cause erosion when it is installed and removed. A temporary culvert can be easily constructed and enables heavy equipment loads to be used. However, culverts create the greatest obstruction to flood flows and are subject to blockage and washout.

The crossing may be designed based on the stream flows resulting from a 2-year 24-hour frequency storm, in which case, Class A or B riprap may be used for normal erosion protection of the aggregate fill, and the roadbed would be at the elevation of the top of the banks. For temporary crossings of streams with large watersheds, the crossing may also be designed based on the low-flow channel conditions as a low water crossing. The culvert size would be adequate to convey base flows, but high water events would overtop the structure and make the crossing temporarily unusable. Additional erosion protection of the fill would be necessary for this design, in the form of Class C or larger riprap to prevent the washout of the culverts.

## Construction Specifications

### All Crossings

- In-stream work should be performed in dry conditions. Utilize a stream diversion or cofferdams to provide dry conditions for conducting the work. Refer to specification **7.42 Stream Diversion Channel**. Clearing of the streambed and banks should be kept to a minimum.
- All surface water from the construction site should be diverted onto undisturbed areas adjoining the stream. Unstable stream banks should be lined with riprap or otherwise be appropriately stabilized.

- The crossing alignment shall be at right angles to the stream. Where approach conditions dictate, the crossing may vary up to 15° from a line drawn perpendicular to the centerline of the stream at the intended crossing location.
- The centerline of both roadway approaches should coincide with the crossing alignment centerline for a minimum distance of 50 feet from each bank of the waterway being crossed. If physical or right-of-way restraints preclude the 50 feet minimum, a shorter distance may be provided. All fill materials associated with the roadway approach shall be limited to a maximum height of 2 feet above the existing flood plain elevation.
- A water diverting structure such as a waterbar diversion should be constructed (across the roadway on both roadway approaches) 50 feet (maximum) on either side of the waterway crossing. This will prevent roadway surface runoff from directly entering the waterway. The 50 feet distance is measured from the top of the waterway bank. If the roadway approach is constructed with a reverse grade away from the waterway, a separate diverting structure is not required.
- The crossing structure should be removed as soon as it is no longer necessary for access. During structure removal, utilize a stream diversion channel or cofferdams to provide dry conditions for conducting the work.
- Upon removal of the crossing structure, the stream shall immediately be restored to its original cross-section and properly stabilized.

### **Temporary Bridge Crossing**

The temporary bridge should be constructed at or above bank elevation to prevent the entrapment of floating materials and debris.

- Abutments should be placed parallel to the stream and on stable banks.
- Bridges should be constructed to span the entire channel. If the channel width exceeds eight feet (as measured from the tops of the banks), a temporary footing, pier, or bridge support may be constructed within the waterway.
- Decking materials should be of sufficient strength to support the anticipated load. Decking materials must be butted tightly to prevent any soil material tracked onto the bridge from falling into the waterway below.
- Bridges should be securely anchored at only one end using steel cable or chain. This will prevent channel obstruction in the event that floodwaters float the bridge. Large trees, large boulders or driven steel anchors can serve as anchors.

### **Temporary Culvert Crossing**

- All culverts must be strong enough to support their cross-sectioned area under maximum expected loads.
- The invert elevation of the culvert should be installed on the natural streambed grade at both ends.
- A geotextile should be placed on the streambed and stream banks prior to the placement of the pipe culvert(s) and aggregate. The geotextile will prevent the migration of soil particles from the subgrade into the graded



stone. The geotextile should cover the streambed and extend a minimum of six inches and a maximum of one foot beyond the end of the culvert and bedding material. Refer to specification **Geotextile**.

- The culverts should extend a minimum of one foot beyond the upstream and downstream toe of the aggregate placed around the culvert.
- The culvert(s) should be covered with small riprap, such as TDOT Class A-1. The depth of riprap above the top of the culvert should be one-half the diameter of the culvert or 18", whichever is greater.
- Multiple culverts should be separated by one-half the diameter of the culvert or 12" whichever distance is greater. A final layer of coarse aggregate, such as TDOT #57, should be applied to minimum depth of 6 inches.

**Maintenance  
and Inspection  
Points**

The structure should be inspected after every rainfall and at least twice a week, and all damages repaired immediately. Any material lost to the stream shall be removed but only after discussion with TDEC staff. The structure should be removed immediately after construction is finished, and the streambed and banks must be stabilized and restored to pre-construction conditions.

**References**

## STREAM PROTECTION PRACTICES

### 7.44 BIOENGINEERED STREAMBANK STABILIZATION



**Definition** Bioengineered streambank stabilization is the use of readily available native plant materials to maintain and enhance stream banks; or to prevent, or repair and restore small stream bank erosion problems.

**Purpose**

- Form a root mat to stabilize and reinforce the soil on the stream bank
- Provide wildlife habitat
- Enhance the appearance of the stream
- Develop the natural stream corridor
- Lower summertime water temperatures providing a healthy aquatic environment

**Conditions Where Practice Applies** Stream bank stabilization techniques may be required if steep slopes and/or hydrologic patterns deem it necessary.

**Planning Considerations** Stream bank stabilization without an NRCS approved plan requires authorization from the Tennessee Division of Water Pollution Control and may require authorization from the United States Army Corps of Engineers. For more information, see:

<http://www.state.tn.us/environment/permits/arap.shtml>.

**Design Criteria** Bioengineering is a streambank stabilization technique that uses natural materials such as grasses, shrubs, trees, roots and logs to manage stream flow and stabilize the banks. Bioengineering is the preferred method of streambank stabilization and is permitted without notification where no work is done in stream with mechanized equipment; and where the work is done in accordance with an approved bioengineering plan from the United States Department of Agriculture, Natural Resource Conservation Service (NRCS).

Design of streambank stabilization must be performed by a professional experienced in stream design.

A low flow channel shall be provided to convey the smaller storms, and a floodplain shall be included to the extent feasible, given site constraints.

### Construction Specifications

Revegetation includes seeding and sodding of grasses in combination with erosion control fabrics, and the planting of woody vegetation (shrubs and trees). Any blankets or matting used within the stream channel shall be jute or other fully biodegradable materials. Floodplain areas can be stabilized with erosion control blankets and/or turf reinforcement mat. Seed or sod used on the streambanks shall be long rooted, native grasses.

**Live Stake:** Fresh, live cut woody plant cuttings are driven into the ground as stakes, intended to root and grow into mature shrubs that will stabilize soils and restore the riparian zone habitat. Live stakes provide no immediate stream bank stabilization. Only certain species of woody plants will work well for this application. Willow species work best.

Live stakes may also be driven into riprap protected banks to help with permanent stabilization, and improve aesthetics.

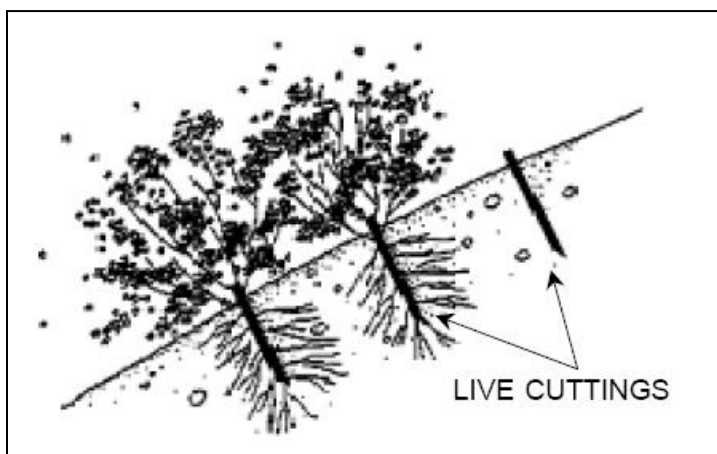

Figure 7.44-1 Live Staking

**Live Fascine:** Live fascines are sausage-like bundles of live cut branches placed into trenches along the stream bank. They provide immediate protection from erosion when properly used and installed. Willow species work best.

Live fascines create very little site disturbance as compared to other systems and works especially well when combined with surface covers such as jute mesh or coir fabrics.

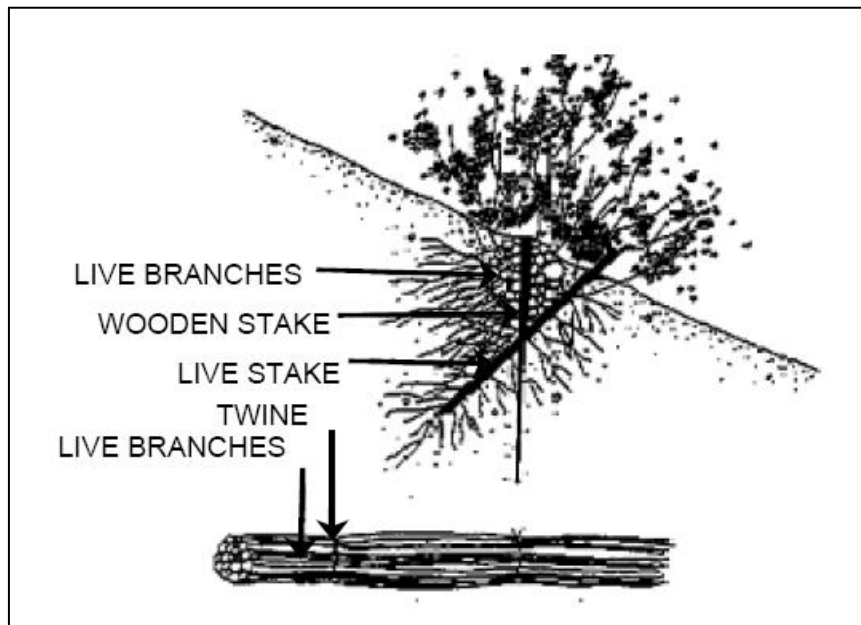

Figure 7.44-2 Live Fascines

**Brushmattress:** A combination of living units that forms an immediate protective surface cover over the stream bank. Living units used include live stakes, live fascines and a mattress branch cover (long, flexible branches placed against the bank surface).

Brushmattresses require a great deal of live material, are complicated as well as expensive to evaluate, design, and install.

Brushmattresses capture sediment during flood conditions, produce habitat rapidly and quickly develop a healthy riparian zone.

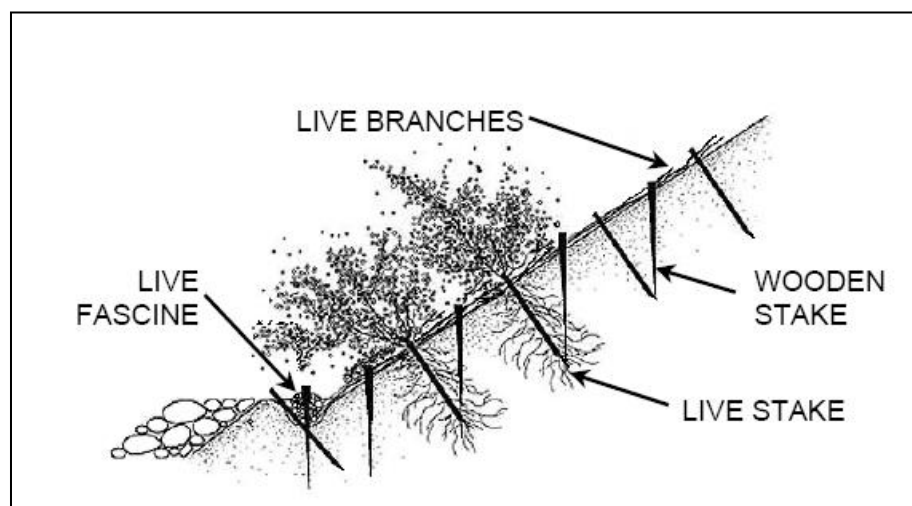

Figure 7.44-3 Brush Mattress

**Live Cribwall:** A rectangular framework of logs or timbers, rock and woody cuttings. This requires a great deal of assessment and understanding of stream behavior. Cribwalls can be complicated and expensive if a supply of wood is not available.

Benefits include developing a natural stream bank or upland slope appearance after it has begun to grow and provides excellent habitat for a variety of fish, birds, and animals. It is very useful where space is limited on small, narrow stream corridors.

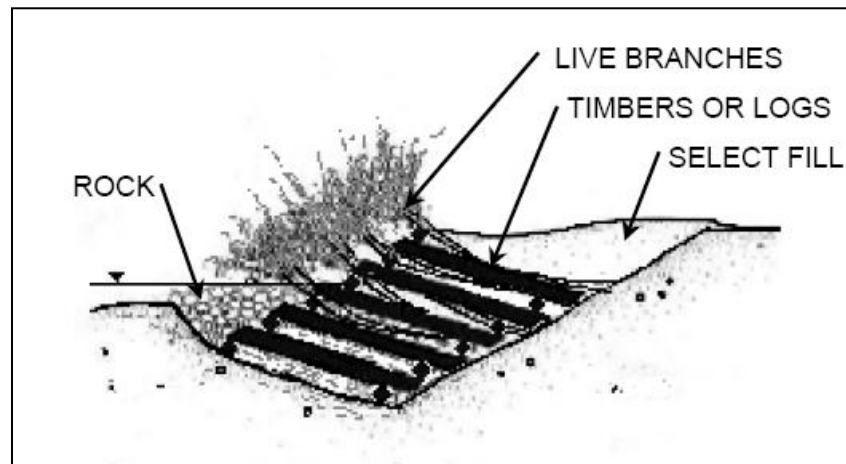

Figure 7.44-4 Live Cribwall

**Branchpacking:** Process of alternating layers of live branches and soil, incorporated into a hole, gully, or slumped-out area in a slope or streambank. There is a moderate to complex level of difficulty for construction.

Branchpacking produces an immediate filter barrier, reducing scouring conditions, repairing gully erosion and providing habitat cover and bank reinforcement. This is one of the most effective and inexpensive methods for repairing holes in earthen embankments along small stream sites.

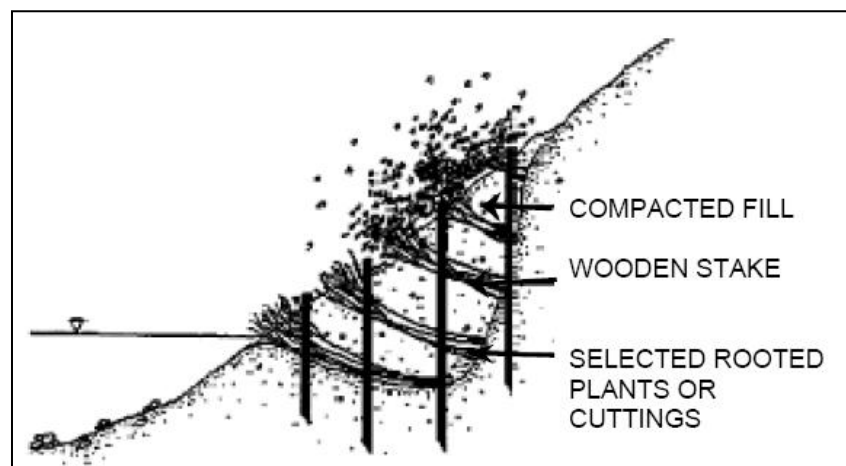

Figure 7.44-5 Branchpacking

**Maintenance  
and Inspection  
Points**

During restoration activities, inspect construction to ensure that sediment control and erosion controls are installed and functioning.

Check for germination or seedling emergence.

The banks should be inspected after every high-water event, fixing gaps in the vegetative cover at once with structural materials or new plants, and mulching if necessary. Fresh cuttings from other plants may be used for repairs.



## 8.0 PROBLEM SOLVING

Problem solving is the action that should occur upon the identification of a failure or a potential failure of stormwater pollution prevention measures on a construction site. Chapter 7 includes common corrective actions and maintenance items for individual measures. Troubleshooting goes beyond the individual measure to address overall site conditions that may cause environmental damage if left unaddressed. Troubleshooting, while primarily the responsibility of the EPSC inspector, should be performed by all individuals performing stormwater related work on the construction project.

### 8.1 Interim Steps

When failure of a measure is imminent or has already occurred yet cannot be fixed immediately, action should still be taken. Interim steps should be taken to prevent any environmental damage from a failure that cannot be prevented or fully addressed at the time. Reasons why a failure may not be addressed immediately or prevented could include the condition of the area (it may be too wet to get into) or the availability of equipment to repair the area. Interim steps may include any (or all) of the following items:

- Install additional sediment barriers downgradient and/or upgradient from the area of concern.
- Apply straw mulch to any disturbed areas upgradient from the area of concern. When the area is too wet for equipment, straw can be applied by hand.
- Cover the area with geotextile or plastic sheeting, if it is not too large.
- Apply a soil binder to prevent further erosion.
- Divert run-on stormwater around the area of concern.

The area of concern should be monitored closely until fixed, and the interim steps taken continually maintained to prevent sediment and other pollutants from migrating off the site until the area can be fully addressed.

### 8.2 Design Related Problems

Design plans are prepared based upon known and anticipated site conditions and construction schedules. However, it is not uncommon for unanticipated site conditions or construction schedule changes to occur. When these new conditions or construction schedule changes affect implementation of the SWPPP in the field, the SWPPP and/or the construction drawings must be modified. As soon as design issues are identified in the field, steps should be taken to remedy the issue.

Some potential design related problems may include:

- No access provided to clean out measures.
- No room to construct a sediment basin, outlet protection or other measure.
- Design did not account for run-on from adjoining properties.

A SWPPP may need to be revised where a repeated or catastrophic failure of a BMP occurred. There may be unforeseen circumstances, such as increased drainage area or increased impervious surfaces, which may have caused the failure. Each failure should be evaluated to determine if site conditions have changed significantly and if redesign of that portion of the SWPPP is necessary.

### 8.3 Construction Related Problems

During inspections, all measures should be checked to verify that they have been installed correctly. Measures can fail if they are improperly installed. For measures that have underground or underwater components, verify that these components are installed correctly during the construction process during inspections.

Other potential construction related issues include:

- Using unsuitable materials as fill.
- Slope failure due to saturated soils, non-cohesive soils, or excessive steepness.
- Failure to install stormwater system components.
- Installing stormwater system components and/or EPSC measures incorrectly.
- Interim construction phase resulting in a larger watershed to a measure than that for which it was intended (e.g. >0.25 acre to 100 feet of silt fence).

When construction related problems occur, they must be documented to aid in understanding why a failure occurred.

### 8.4 Sediment Releases

Anomalous weather events are those that produce runoff events that are greater than the design storm required for the project by the CGP. The design requirement for EPSC measures is either the 2-yr or 5-yr storm event. EPSC measures are not required to treat storms beyond these design storms. Large storm events cannot be predicted with great confidence and often cause failure of a BMP. Track rainfall depth and duration on the project to verify if the design storm has been exceeded. Failure of measures due to design storm exceedance does not automatically constitute a violation of the TNCGP. However, the site operator is still responsible for repairing any damage caused by the release.

When sediment is released from the construction site into a receiving stream or wetland, immediate action is necessary. The inspector should document the release through an inspection report and with photographs. TDEC and the local regulator, if appropriate, should be contacted to determine the best course of action for repair. Interim steps, as outlined in Section 8.1, should be taken to prevent additional damage. All work in streams and wetlands must be approved by TDEC's Water Pollution Control office. Depending on the severity of the release, an ARAP may be necessary to clean up and restore the area.

### 8.5 Spills

When spills of chemicals used or stored on the project occur, immediate response is necessary. Spill cleanup and response materials should be onsite at all times. Absorbent materials should be used to absorb the spills. The absorbent materials must then be properly disposed. Where the spill gets into the soil, the soil should be excavated, properly treated and contained. Contact the TDEC field office for guidance on the proper handling and treatment of contaminated soils.

For fuel or solvent spills into a stream, river, or lake, contact the National Response Center at 1-800-424-8802. The NRC is the federal government's centralized reporting center, which is staffed 24 hours per day by U.S. Coast Guard personnel. If reporting directly to NRC is not practicable, reports also can be made to the EPA regional office.

## 8.6 Buffer Disturbances

Unless specifically addressed in the SWPPP, stream buffers are to remain undisturbed. These areas should not be used to store equipment or construction materials either. In the event that a buffer is disturbed, a buffer restoration or mitigation plan should be developed that addresses stabilizing and replanting the areas impacted. The plan should address the following items:

- **Soil stabilization.** Groundcovers sufficient to restrain erosion in the buffer are required. These groundcovers can be grasses, as specified in Chapter 7.
- **Canopy restoration.** Where trees have been removed or damaged, tree and shrub replanting is necessary. Visually survey and inventory the surrounding buffer area trees to determine the type of trees to replant in the buffer. Trees should be replanted at a rate consistent with the rates and types of trees recommended by the TN Department of Agriculture Division of Forestry.
- **Stormwater management.** Prevent stormwater from concentrating in the buffer area. Restore sheetflow where it previously existed. Level spreaders, energy dissipaters and other management techniques should be employed to manage runoff to prevent concentrated flows from discharging into the buffer.

The buffer restoration or mitigation plan should be maintained with the field SWPPP and available for review by TDEC and the local municipality. Check with the local municipality to see if the plan must be submitted to them for approval prior to beginning restoration in the buffer.

## 9.0 PERFORMING INSPECTIONS

The inspector has a unique and vital position on the construction site. His experience and observations help protect streams and other natural resources from negative impacts from construction sites. This section covers an inspector's role, as well as guidance on the process of inspections and inspection documentation.

### 9.1 The Role of the Inspector

The TN Construction General Permit defines the EPSC inspector as follows:

*An inspector is a person that has successfully completed (has a valid certification from) the "Fundamentals of Erosion Prevention and Sediment Control Level I" course or equivalent course. An inspector performs and documents the required inspections, paying particular attention to time-sensitive permit requirements such as stabilization and maintenance activities. An inspector may also have the following responsibilities:*

- a. Oversee the requirements of other construction-related permits, such as Aquatic Resources Alteration Permit or Corps of Engineers permit for construction activities in or around Waters of the State;*
- b. Update field SWPPPs;*
- c. Conduct pre-construction inspection to verify that undisturbed areas have been properly marked and initial measures have been installed; and*
- d. Inform the permit holder of activities that may be necessary to gain or remain in compliance with the CGP and other environmental permits.*

The inspector must be knowledgeable about all construction related permits on the site, as well as being knowledgeable about stormwater pollution prevention practices. Figure 9-1 below depicts an inspector's role in understanding regulations. The EPSC inspector should also be familiar with construction methods and should know when to make a recommendation onsite or to involve the designer.

An inspector's primary responsibilities are to document site conditions and keep the field SWPPP current. Therefore, an inspector must have the technical expertise in stormwater pollution prevention. In addition, the inspector must be able to deal effectively with people. The inspector must be able to communicate clear guidance to contractors, engineers, and developers to maintain compliance at a site. **It is NOT the responsibility of the inspector to maintain or achieve compliance at a construction site – rather, it is simply to notify the permit holder of the measures needed to stay in compliance.**

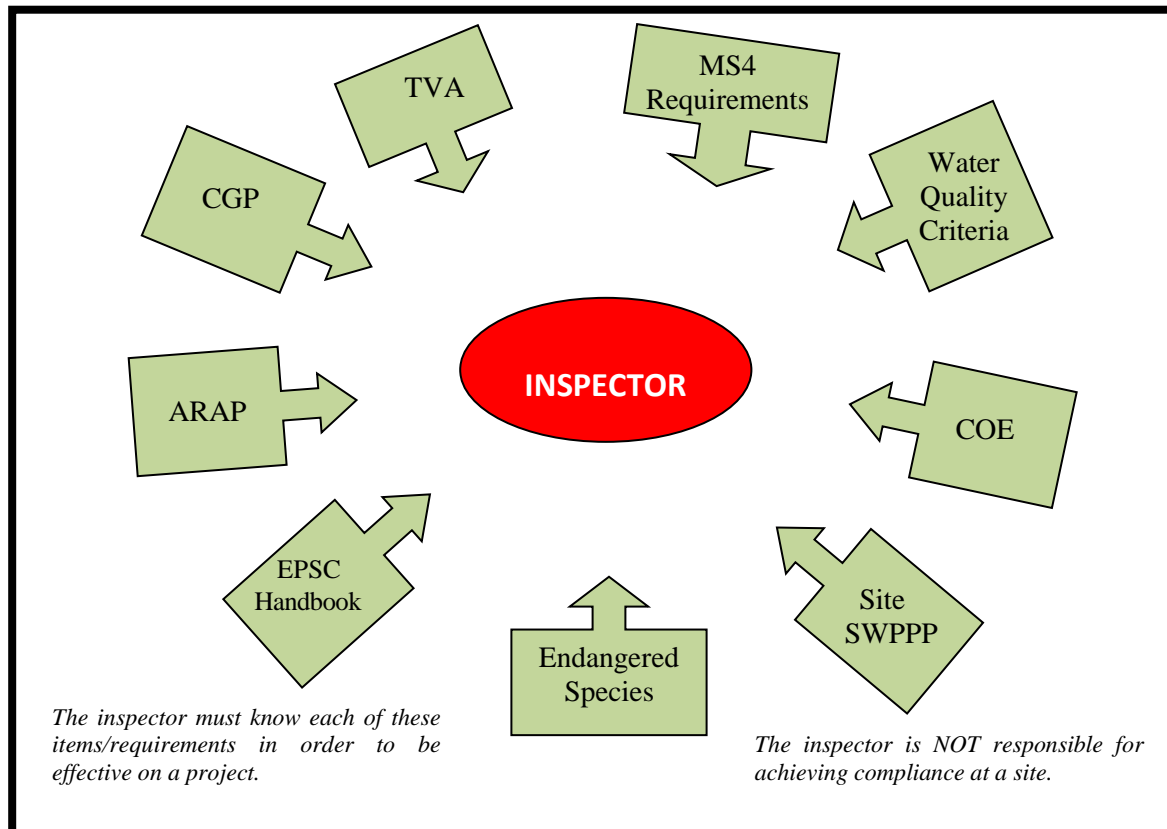

**Figure 9-1 The Role of the Inspector: Understanding Requirements**

## 9.2 Performing the inspection

The inspection process should be founded on the following principles of erosion prevention and sediment control:

- Limit the disturbed area
- Phase the construction project
- Protect the soil surface from erosion
- Manage runoff volume and keep velocities low
- Capture sediment near the source
- Maintain the stormwater management system
- Keep sediment on the site

The EPSC inspector must be familiar with these principles and know how to apply them on the construction site.

Prior to beginning the inspection, the inspector should fully familiarize himself with the SWPPP and all associated permit requirements. Know the locations of all of the outfalls, the areas that are not to be disturbed and the phase of construction. Identify the natural resources within or adjacent to the project. The inspector's goal should be to keep the disturbed area minimized to control erosion and minimize maintenance.

### **Inspection Guidance**

- ✓ Participate in the pre-construction inspection and/or meetings. Environmentally sensitive areas, ARAP boundaries, and areas to be left undisturbed should be identified and marked in the field prior to beginning land disturbing activities.
- ✓ Begin the inspection by first coordinating with the contractor and the developer or site operator. Performing the inspections with the contractor and the site operator ensures good communication between all parties. Take a copy of the latest field SWPPP especially on larger sites, to better understand the site and the design intent. This is particularly helpful when making a recommendation for insufficient measures because the contractor may have simply not installed exactly what was called for in the plan.
- ✓ Walk the perimeter of the site on the downstream side of measures and the disturbed area. Pay particular attention to outfalls and areas where runoff discharges from the construction site. Verify that buffers and other undisturbed areas have not been damaged by equipment or storage practices. Note sediment deposition beyond the permitted limits, in streams, or wetlands. Note the conditions of all EPSC measures. Look for evidence of erosion beginning.
- ✓ Estimate the total disturbed acreage. Note areas that have been permanently or temporarily stabilized. Note germination or evidence of erosion. Verify that areas to remain undisturbed have not been disturbed. Indicate where construction activities have temporarily or permanently ceased and note in the inspection report that these areas must be stabilized within 15 days.
- ✓ Inspect all controls interior to the site, including erosion prevention measures, sediment control measures, and pollution prevention controls. Where controls need maintenance, repair, or to be installed, indicate this on the EPSC inspection report. Note that the site operator must complete the identified items before the next rain event or no later than 7 days after the date the items were identified to remain in compliance. Identify potential failures and site problems, not simply failures after they have occurred.
- ✓ Before recommending corrective actions, understand *why* the corrective actions are needed. Is the BMP the right BMP for the location and drainage area? Was it installed correctly? Was it maintained correctly? Determine the answers to these questions prior to recommending corrective actions related to BMPs.
- ✓ Document changes on the field SWPPP. Indicate where measures have been removed or installed. Also indicate areas that have been permanently stabilized.
- ✓ Once construction has been completed, the site must be permanently stabilized. All areas disturbed by construction must be finally stabilized with a permanent groundcover sufficient to restrain erosion. Final stabilization is defined in the CGP as a uniform perennial vegetative cover with a uniform density of at least 70 percent of the native (preferably) background vegetative cover for the areas disturbed by construction and areas not covered by permanent structures, and all slopes and channels have been permanently stabilized. Once final stabilization has been achieved, the site operator can submit the Notice of Termination.



- ✓ Communicate the inspection findings to the permit holder and contractor, including recommendations to maintain compliance with existing permits, environmental requirements, and the site SWPPP. When site conditions warrant, inform the permit holder of the need to contact the SWPPP designer for changes or modifications to major components of the SWPPP. Discuss construction staging and scheduling with the contractor and permit holder so you are aware of the next construction activities to be performed onsite.

### 9.3 Documentation

Complete an inspection report for all inspections. The CGP requires inspection be performed at least twice a week, 72 hours or more apart. Document the findings of the inspection fully in the report, and provide a copy to the site operator and the contractor. Document that the rain gage has been read and rainfall recorded on a daily basis or that a reference site has been used to document rainfall. The inspector should also document that all records are being completed and maintained per the TN CGP.

It is highly recommended that inspectors use photo documentation to clearly convey recommendations to the site operator and contractor. Photos also document site conditions over time to support the inspection report findings when the site is audited by TDEC or other regulators. Some inspectors have even walked streams prior to a project with a video camera to more comprehensively document conditions before construction begins.

As noted above, an inspection report must be completed for all inspections to document the inspection findings. This documentation should include the rainfall since the last inspection. Photos taken during each inspection should be catalogued for reference during site audits.

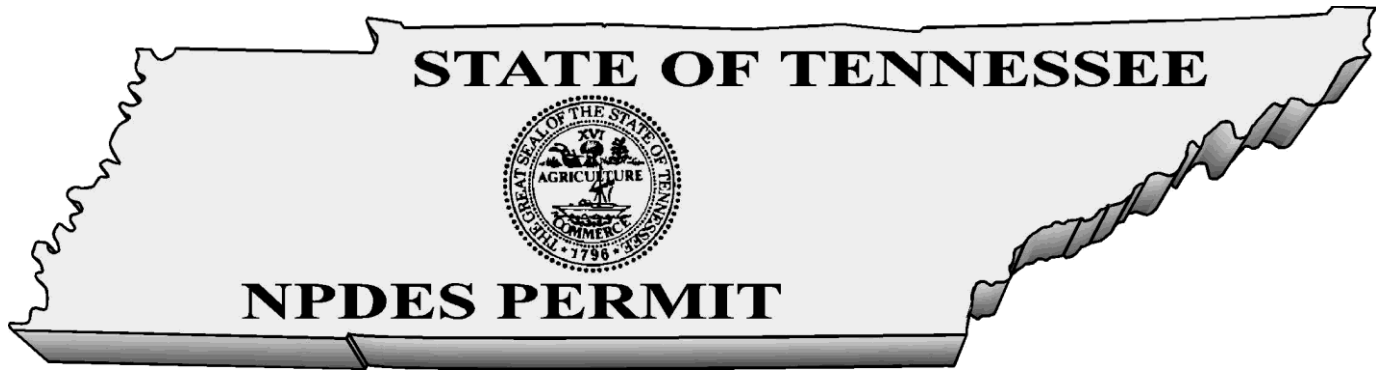

**GENERAL NPDES PERMIT**  
**FOR DISCHARGES OF STORMWATER**  
**ASSOCIATED WITH CONSTRUCTION ACTIVITIES**

**PERMIT NO. TNR100000**

Under authority of the Tennessee Water Quality Control Act of 1977 ([T.C.A. 69-3-101](#) et seq.) and the authorization by the United States Environmental Protection Agency under the Federal Water Pollution Control Act, as amended by the Clean Water Act of 1977 ([33 U.S.C. 1251](#), et seq.) and the [Water Quality Act of 1987, P.L. 100-4](#), including special requirements as provided in part 5.4 (Discharges into Impaired or Exceptional Tennessee Waters) of this general permit, operators of point source discharges of stormwater associated with construction activities into waters of the State of Tennessee, are authorized to discharge stormwater associated with construction activities in accordance with the following permit monitoring and reporting requirements, effluent limitations, and other provisions as set forth in parts 1 through 10 herein, from the subject outfalls to waters of the State of Tennessee.

This permit is issued on: **May 23, 2011**

This permit is effective on: **May 24, 2011**

This permit expires on: **May 23, 2016**

A handwritten signature in blue ink, appearing to read "P. Davis".

for Paul E. Davis, P.E., Director  
Division of Water Pollution Control

**Tennessee General Permit No. TNR100000**  
**Stormwater Discharges Associated with Construction Activities**

---

Table of Contents

---

<b>1.</b>	<b>COVERAGE UNDER THIS GENERAL PERMIT .....</b>	<b>1</b>
<b>1.1.</b>	<b>Permit Area .....</b>	<b>1</b>
<b>1.2.</b>	<b>Discharges Covered by this Permit.....</b>	<b>1</b>
1.2.1.	Stormwater discharges associated with construction activities.....	1
1.2.2.	Stormwater discharges associated with construction support activities.....	1
1.2.3.	Non-stormwater discharges authorized by this permit .....	2
1.2.4.	Other NPDES-permitted discharges .....	2
<b>1.3.</b>	<b>Limitations on Coverage .....</b>	<b>2</b>
<b>1.4.</b>	<b>Obtaining Permit Coverage.....</b>	<b>4</b>
1.4.1.	Notice of Intent (NOI) .....	4
1.4.2.	Stormwater Pollution Prevention Plan (SWPPP) .....	5
1.4.3.	Permit application fees .....	5
1.4.4.	Submittal of a copy of the NOC and NOT to the local MS4.....	6
1.4.5.	Permit Coverage through Qualifying Local Program.....	6
<b>1.5.</b>	<b>Effective Date of Coverage .....</b>	<b>6</b>
1.5.1.	Notice of Coverage (NOC) .....	6
1.5.2.	Permit tracking numbers .....	7
<b>2.</b>	<b>NOTICE OF INTENT (NOI) REQUIREMENTS.....</b>	<b>7</b>
<b>2.1.</b>	<b>Who Must Submit an NOI? .....</b>	<b>7</b>
<b>2.2.</b>	<b>Typical Construction Site Operators.....</b>	<b>8</b>
2.2.1.	Owner/Developer.....	8
2.2.2.	Commercial builders.....	8
2.2.3.	Contractors.....	8
<b>2.3.</b>	<b>Responsibilities of Operators .....</b>	<b>8</b>
2.3.1.	Permittee(s) with design control (owner/developer) .....	9
2.3.2.	Permittee(s) with day-to-day operational control (contractor – secondary permittee).....	9
<b>2.4.</b>	<b>NOI Submittal.....</b>	<b>10</b>
2.4.1.	Existing site .....	10
2.4.2.	Application for new permit coverage .....	10
2.4.3.	New operator .....	10
2.4.4.	Late NOIs.....	11
<b>2.5.</b>	<b>Who Must Sign the NOI?.....</b>	<b>11</b>
<b>2.6.</b>	<b>NOI Form .....</b>	<b>11</b>

2.6.1.	Contents of the NOI form .....	11
2.6.2.	Construction site map .....	11
2.6.3.	Application completeness .....	12
<b>2.7.</b>	<b>Where to Submit the NOI, SWPPP and Permitting Fee? .....</b>	<b>12</b>
<b>2.8.</b>	<b>List of the TDEC Environmental Field Offices (EFOs) and Corresponding Counties .....</b>	<b>12</b>
<b>3.</b>	<b>STORMWATER POLLUTION PREVENTION PLAN (SWPPP) REQUIREMENTS .....</b>	<b>13</b>
<b>3.1.</b>	<b>The General Purpose of the SWPPP .....</b>	<b>13</b>
3.1.1.	Registered engineer or landscape architect requirement .....	13
3.1.2.	Site Assessment .....	14
<b>3.2.</b>	<b>SWPPP Preparation and Compliance .....</b>	<b>15</b>
3.2.1.	Existing site .....	15
3.2.2.	New site .....	15
<b>3.3.</b>	<b>Signature Requirements, Plan Review and Making Plans Available.....</b>	<b>15</b>
3.3.1.	Signature Requirements for a SWPPP.....	15
3.3.2.	SWPPP Review .....	15
3.3.3.	Making plans available .....	15
<b>3.4.</b>	<b>Keeping Plans Current.....</b>	<b>15</b>
3.4.1.	SWPPP modifications.....	15
<b>3.5.</b>	<b>Components of the SWPPP .....</b>	<b>16</b>
3.5.1.	Site description .....	16
3.5.2.	Description of stormwater runoff controls .....	17
3.5.3.	Erosion prevention and sediment controls .....	18
3.5.4.	Stormwater management .....	22
3.5.5.	Other items needing control .....	23
3.5.6.	Approved local government sediment and erosion control requirements .....	23
3.5.7.	Maintenance.....	23
3.5.8.	Inspections .....	23
3.5.9.	Pollution prevention measures for non-stormwater discharges.....	25
3.5.10.	Documentation of permit eligibility related to Total Maximum Daily Loads (TMDL) .....	25
<b>4.</b>	<b>CONSTRUCTION AND DEVELOPMENT EFFLUENT GUIDELINES.....</b>	<b>25</b>
<b>4.1.</b>	<b>Non-Numeric Effluent Limitations.....</b>	<b>25</b>
4.1.1.	Erosion Prevention and Sediment Controls.....	25
4.1.2.	Buffer zone requirements .....	26
4.1.3.	Soil stabilization .....	27
4.1.4.	Dewatering.....	27
4.1.5.	Pollution prevention measures.....	28
4.1.6.	Prohibited discharges.....	28
4.1.7.	Surface outlets .....	28

<b>5.</b>	<b>SPECIAL CONDITIONS, MANAGEMENT PRACTICES, AND OTHER NON-NUMERIC LIMITATIONS.....</b>	<b>28</b>
<b>5.1.</b>	<b>Releases in Excess of Reportable Quantities.....</b>	<b>28</b>
<b>5.2.</b>	<b>Spills.....</b>	<b>29</b>
<b>5.3.</b>	<b>Discharge Compliance with State Water Quality Standards.....</b>	<b>29</b>
5.3.1.	Violation of Water Quality Standards .....	29
5.3.2.	Discharge quality .....	29
<b>5.4.</b>	<b>Discharges into Impaired or Exceptional Tennessee Waters .....</b>	<b>30</b>
5.4.1.	Additional SWPPP/BMP Requirements for discharges into impaired or exceptional TN Waters .....	30
5.4.2.	Buffer zone requirements for discharges into impaired or exceptional TN waters.....	31
5.4.3.	Pre-Approved sites.....	32
<b>6.</b>	<b>RETENTION, ACCESSIBILITY AND SUBMISSION OF RECORDS .....</b>	<b>32</b>
<b>6.1.</b>	<b>Documents .....</b>	<b>32</b>
<b>6.2.</b>	<b>Accessibility and Retention of Records .....</b>	<b>32</b>
6.2.1.	Posting information at the construction site .....	33
<b>6.3.</b>	<b>Electronic Submission of NOIs, NOTs and Reports .....</b>	<b>33</b>
<b>7.</b>	<b>STANDARD PERMIT CONDITIONS .....</b>	<b>33</b>
<b>7.1.</b>	<b>Duty to Comply .....</b>	<b>33</b>
7.1.1.	Permittee's duty to comply.....	33
7.1.2.	Penalties for violations of permit conditions.....	34
7.1.3.	Civil and criminal liability.....	34
7.1.4.	Liability under state law .....	34
<b>7.2.</b>	<b>Continuation of the Expired General Permit .....</b>	<b>34</b>
<b>7.3.</b>	<b>Need to Halt or Reduce Activity Not a Defense .....</b>	<b>35</b>
<b>7.4.</b>	<b>Duty to Mitigate .....</b>	<b>35</b>
<b>7.5.</b>	<b>Duty to Provide Information .....</b>	<b>35</b>
<b>7.6.</b>	<b>Other Information .....</b>	<b>35</b>
<b>7.7.</b>	<b>Signatory Requirements.....</b>	<b>35</b>
7.7.1.	Signatory requirements for a Notice of Intent (NOI) .....	36
7.7.2.	Signatory requirements for reports and other items .....	36
7.7.3.	Duly authorized representative .....	37
7.7.4.	Changes to authorization .....	37
7.7.5.	Signatory requirements for primary permittees .....	37
7.7.6.	Signatory requirements for secondary permittees .....	37
<b>7.8.</b>	<b>Penalties for Falsification of Reports .....</b>	<b>38</b>
<b>7.9.</b>	<b>Oil and Hazardous Substance Liability.....</b>	<b>38</b>

<b>7.10.</b>	<b>Property Rights.....</b>	<b>38</b>
<b>7.11.</b>	<b>Severability.....</b>	<b>38</b>
<b>7.12.</b>	<b>Requiring an Individual Permit .....</b>	<b>38</b>
7.12.1.	Director can require a site to obtain an individual permit.....	38
7.12.2.	Permittee may request individual permit instead of coverage under this general permit.....	39
7.12.3.	Individual permit terminates general permit.....	39
<b>7.13.</b>	<b>Other, Non-Stormwater, Program Requirements.....</b>	<b>39</b>
<b>7.14.</b>	<b>Proper Operation and Maintenance.....</b>	<b>40</b>
<b>7.15.</b>	<b>Inspection and Entry .....</b>	<b>40</b>
<b>7.16.</b>	<b>Permit Actions .....</b>	<b>40</b>
<b>8.</b>	<b>REQUIREMENTS FOR TERMINATION OF COVERAGE.....</b>	<b>40</b>
<b>8.1.</b>	<b>Termination of Developer and Builder Coverage .....</b>	<b>40</b>
8.1.1.	Termination process for primary permittees .....	40
8.1.2.	NOT review .....	41
<b>8.2.</b>	<b>Termination of Builder and Contractor Coverage.....</b>	<b>42</b>
8.2.1.	Termination process for secondary permittees.....	42
<b>8.3.</b>	<b>NOT certification.....</b>	<b>42</b>
<b>8.4.</b>	<b>Where to Submit a Notice of Termination (NOT)?.....</b>	<b>42</b>
<b>9.</b>	<b>AQUATIC RESOURCE ALTERATION PERMITS (ARAP).....</b>	<b>42</b>
<b>10.</b>	<b>DEFINITIONS.....</b>	<b>43</b>
<b>11.</b>	<b>LIST OF ACRONYMS .....</b>	<b>50</b>

- APPENDIX A – Notice of Intent (NOI) Form**
- APPENDIX B – Notice of Termination (NOT) Form**
- APPENDIX C – Inspection Report Form**
- APPENDIX D – Stormwater Monitoring Report Form**



## 1. COVERAGE UNDER THIS GENERAL PERMIT

### 1.1. Permit Area

This construction general permit (CGP) covers all areas of the State of Tennessee.

### 1.2. Discharges Covered by this Permit

#### 1.2.1. Stormwater discharges associated with construction activities

This permit authorizes point source discharges of stormwater from construction activities including clearing, grading, filling and excavating (including borrow pits and stockpile/material storage areas containing erodible material), or other similar construction activities that result in the disturbance of one acre or more of total land area. Projects or developments of less than one acre of land disturbance are required to obtain authorization under this permit if the construction activities at the site are part of a larger common plan of development or sale that comprise at least one acre of land disturbance. One or more site [operators](#) must maintain coverage under this permit for all portions of a site that have not been finally stabilized.

Projects or developments of less than one acre of total land disturbance may also be required to obtain authorization under this permit if:

- a) the director has determined that the stormwater discharge from a site is causing, contributing to, or is likely to contribute to a violation of a state water quality standard;
- b) the director has determined that the stormwater discharge is, or is likely to be a significant contributor of pollutants to [waters of the state](#), or
- c) changes in state or federal rules require sites of less than one acre that are not part of a larger common plan of development or sale to obtain a stormwater permit.

Note: Any discharge of stormwater or other fluid to an improved sinkhole or other injection well, as defined, must be authorized by permit or rule as a Class V underground injection well under the provisions of TDEC Rules, Chapter [1200-4-6](#).

#### 1.2.2. Stormwater discharges associated with construction support activities

This permit also authorizes stormwater discharges from support activities associated with a permitted construction site (e.g., concrete or asphalt batch plants, equipment staging yards, material storage areas, excavated material disposal areas, borrow areas) provided all of the following are met:

- a) the support activity is primarily related to a construction site that is covered under this general permit;
- b) the [operator](#) of the support activity is the same as the [operator](#) of the construction site;
- c) the support activity is not a commercial operation serving multiple unrelated construction projects by different [operators](#);
- d) the support activity does not operate beyond the completion of the construction activity of the last construction project it supports; and

- e) support activities are identified in the Notice of Intent (NOI) and the Stormwater Pollution Prevention Plan (SWPPP). The appropriate erosion prevention and sediment controls and measures applicable to the support activity shall be described in a comprehensive SWPPP covering the discharges from the support activity areas.

TDOT projects shall be addressed in the [Waste and Borrow Manual](#) per the [Statewide Stormwater Management Plan \(SSWMP\)](#). Stormwater discharges associated with support activities that have been issued a separate individual permit or an alternative general permit are not authorized by this general permit. This permit does not authorize any process wastewater discharges from support activities. Process wastewater discharges from support activities must be authorized by an individual permit or other appropriate general permit.

#### 1.2.3. Non-stormwater discharges authorized by this permit

The following non-stormwater discharges from active construction sites are authorized by this permit provided the non-stormwater component of the discharge is in compliance with section 3.5.9 below (*Pollution prevention measures for non-stormwater discharges*):

- a) dewatering of work areas of collected stormwater and ground water (filtering or chemical treatment may be necessary prior to discharge);
- b) waters used to wash vehicles (of dust and soil, not process materials such as oils, asphalt or concrete) where detergents are not used and detention and/or filtering is provided before the water leaves site;
- c) water used to control dust in accordance with section 3.5.5 below;
- d) potable water sources including waterline flushings from which chlorine has been removed to the maximum extent practicable;
- e) routine external building washdown that does not use detergents or other chemicals;
- f) uncontaminated groundwater or spring water; and
- g) foundation or footing drains where flows are not contaminated with pollutants (process materials such as solvents, heavy metals, etc.).

All non-stormwater discharges authorized by this permit must be free of sediment or other solids and must not cause erosion of soil or the stream bank, or result in sediment impacts to the receiving stream.

#### 1.2.4. Other NPDES-permitted discharges

Discharges of stormwater or wastewater authorized by and in compliance with a different NPDES permit (other than this permit) may be mixed with discharges authorized by this permit.

### 1.3. **Limitations on Coverage**

Except for discharges from support activities, as described in section 1.2.2 above and certain non-stormwater discharges listed in section 1.2.3 above, all discharges covered by this permit shall be composed entirely of stormwater. This permit does not authorize the following discharges:

- a) Post-Construction Discharges (Permanent Stormwater Management) - Stormwater discharges associated with construction activity that originate from the construction site

- after construction activities have been completed, the site has undergone final stabilization, and the coverage under this permit has been terminated.
- b) Discharges Mixed with Non-Stormwater - Discharges that are mixed with sources of non-stormwater, other than discharges which are identified in section 1.2.4 above (*Other NPDES-permitted discharges*) and in compliance with section 3.5.9 below (*Pollution prevention measures for non-stormwater discharges*) of this permit.
  - c) Discharges Covered by Another Permit - Stormwater discharges associated with construction activity that have been issued an individual permit in accordance with subpart 7.12 below (*Requiring an Individual Permit*).
  - d) Discharges Threatening Water Quality - Stormwater discharges from construction sites, that the director determines will cause, have the reasonable potential to cause, or contribute to violations of water quality standards. Where such determination has been made, the discharger will be notified by the director in writing that an individual permit application is necessary as described in subpart 7.12 below (*Requiring an Individual Permit*). However, the division may authorize coverage under this permit after appropriate controls and implementation procedures have been included in the **SWPPP** that are designed to bring the discharge into compliance with water quality standards.
  - e) Discharges into Impaired Streams – This permit does not authorize discharges that would add loadings of a pollutant that is identified as causing or contributing to the impairment of a water body on the list of **impaired waters**. **Impaired waters** means any segment of surface waters that has been identified by the division as failing to support its designated classified uses. Compliance with the additional requirements set forth in sub-part 5.4 is not considered as contributing to loadings to **impaired waters** or degradation unless the division determines upon review of the SWPPP that there is a reason to limit coverage as set forth in paragraph d) above and the SWPPP cannot be modified to bring the site into compliance.
  - f) Discharges into Outstanding National Resource Waters - The director shall not grant coverage under this permit for discharges into waters that are designated by the Water Quality Control Board as Outstanding National Resource Waters (ONRWs). Designation of ONRWs are made according to TDEC Rules, [Chapter 1200-4-3-.06](#).
  - g) Discharges into Exceptional Quality Waters - The director shall not grant coverage under this permit for potential discharges of pollutants which would cause degradation to waters designated by TDEC as exceptional quality waters (see sub-part 5.4 (Discharges into Impaired or Exceptional Tennessee Waters for additional permit requirements). Compliance with the additional requirements set forth in sub-part 5.4 is not considered as contributing to loadings to exceptional quality waters or degradation unless the division determines upon review of the SWPPP that there is a reason to limit coverage as set forth in paragraph d) above and the SWPPP cannot be modified to bring the site into compliance. Identification of exceptional quality waters is made according to TDEC Rules, [Chapter 1200-4-3-.06](#).
  - h) Discharges Not Protective of Federal or State listed Threatened and Endangered Species, Species Deemed in Need of Management or Special Concern Species - Stormwater discharges and stormwater discharge-related activities that are not protective of legally protected listed or proposed threatened or endangered aquatic fauna or flora (or species proposed for such protection) in the receiving stream(s); or discharges or activities that would result in a “take” of a state or federal listed endangered or threatened aquatic or wildlife species deemed in need of management or special concern species, or such species’ habitat. If the division finds that stormwater discharges or stormwater related activities are likely to result in any of the above effects, the director will deny the

coverage under this general permit unless and until project plans are changed to adequately protect the species.

- i) Discharges from a New or Proposed Mining Operation - This permit does not cover discharges from a new or proposed mining operation.
- j) Discharges Negatively Affecting a Property on the National Historic Register - Stormwater discharges that would negatively affect a property that is listed or is eligible for listing in the [National Historic Register](#) maintained by the Secretary of Interior.
- k) Discharging into Receiving Waters With an Approved Total Maximum Daily Load Analysis - Discharges of pollutants of concern to waters for which there is an EPA-approved total maximum daily load (TMDL) for the same pollutant are not covered by this permit unless measures or controls that are consistent with the assumptions and requirements of such TMDL are incorporated into the SWPPP. If a specific wasteload allocation has been established that would apply to the discharge, that allocation must be incorporated into the SWPPP and steps necessary to meet that allocation must be implemented. In a situation where an EPA-approved or established TMDL has specified a general wasteload allocation applicable to construction stormwater discharges, but no specific requirements for construction sites have been identified, the permittee should consult with the division to confirm that adherence to a SWPPP that meets the requirements of this permit will be consistent with the approved TMDL. Where an EPA-approved or established TMDL has not specified a wasteload allocation applicable to construction stormwater discharges, but has not specifically excluded these discharges, adherence to a SWPPP that meets the requirements of the CGP will generally be assumed to be consistent with the approved TMDL. If the EPA-approved or established TMDL specifically precludes construction stormwater discharges, the operator is not eligible for coverage under the CGP.

#### 1.4. Obtaining Permit Coverage

Submitting a complete NOI, a SWPPP and an appropriate permitting application fee are required to obtain coverage under this general permit. Requesting coverage under this permit means that an applicant has obtained and examined a copy of this permit, and thereby acknowledges applicant's claim of ability to comply with permit terms and conditions. Upon completing NOI review, the division will:

- a) issue a notice of coverage (NOC) to the operator identified as a primary permittee on the NOI form (see subpart 1.5 below - *Effective Date of Coverage*); or
- b) notify the applicant of needed changes to their NOI submittal (see section 2.6.3 below - *Application completeness*); or
- c) deny coverage under this general permit (see subpart 7.12 below - *Requiring an Individual Permit*).

##### 1.4.1. Notice of Intent (NOI)

Operators wishing to obtain coverage under this permit must submit a completed NOI in accordance with requirements of part 2 below, using the NOI form provided in Appendix A of this permit (or a copy thereof). The division will review NOIs for completeness and accuracy and, when deemed necessary, investigate the proposed project for potential impacts to the [waters of the state](#).

#### 1.4.2. Stormwater Pollution Prevention Plan (SWPPP)

**Operators** wishing to obtain coverage under this permit must develop and submit a site-specific **SWPPP** with the NOI. The initial, comprehensive **SWPPP**, developed and submitted by the site-wide permittee (typically owner/developer who applied for coverage at project commencement<sup>1</sup>), should address all construction-related activities from the date construction commences to the date of termination of permit coverage, to the maximum extent practicable. The **SWPPP** must be developed, implemented and updated according to the requirements in part 3 below (*SWPPP Requirements*) and subpart 2.3 below (*Responsibilities of Operators*). The **SWPPP** must be implemented prior to commencement of construction activities.

If the initial, comprehensive **SWPPP** does not address all activities until final stabilization of the site, an updated **SWPPP** or addendums to the plan addressing all aspects of current site disturbance must be prepared. An active, updated **SWPPP** must be in place for all disturbed portions of a site until each portion has been completed and finally stabilized.

Preparation and implementation of the comprehensive **SWPPP** may be a cooperative effort with all **operators** at a site. New **operators** with design and operational control of their portion of the construction site are expected to adopt, modify, update and implement a comprehensive **SWPPP**. Primary permittees at the site may develop a **SWPPP** addressing only their portion of the project, as long as the proposed **Best Management Practices (BMPs)** are compatible with the comprehensive **SWPPP** and complying with conditions of this general permit.

#### 1.4.3. Permit application fees

The permit application fee should accompany the site-wide permittee's NOI form. The fee is based on the total acreage planned to be disturbed by an entire construction project for which the site-wide permittee is requesting coverage, including any associated construction support activities (see section 1.2.2 above). *The disturbed area* means the total area presented as part of the development (and/or of a larger common plan of development) subject to being cleared, graded, or excavated during the life of the development. The area cannot be limited to only the portion of the total area that the site-wide owner/developer initially disturbs through the process of various land clearing activities and/or in the construction of roadways, sewers and water utilities, stormwater drainage structures, etc., to make the property marketable. The site-wide owner/developer may present documentation of common areas in the project that will not be subject to disturbance at anytime during the life of the project and have these areas excluded from the fee calculation.

The application fees shall be as specified in the TDEC Rules, [Chapter 1200-4-11](#). The application will be deemed incomplete until the appropriate application fee is paid in full. Checks for the appropriate fee should be made payable to "Treasurer, State of Tennessee." There is no additional fee for subsequent owner/**operator** to obtain permit coverage (see section 2.4.3 below - *New operator*), as long as the site-wide primary permittee has active permit coverage at the time of receipt of the subsequent **operator's** application, because the site-wide primary permittee paid the appropriate fee for the entire area of site disturbance. If a project was previously permitted, but permit coverage was terminated (see section 8.1.1 below - Termination process for primary permittees), and subsequent site disturbance or re-development occurs, the new **operator** must obtain coverage and pay the appropriate fee for the disturbed acreage.

---

<sup>1</sup> See sub-part 2.1 on page 7 for a definition of an site-wide permittee.

1.4.4. Submittal of a copy of the NOC and NOT to the local MS4

Permittees who discharge stormwater through an NPDES-permitted municipal separate storm sewer system ([MS4](#)) who are not exempted in section 1.4.5 below (*Permit Coverage through Qualifying Local Program*) must submit a courtesy copy of the notice of coverage (NOC), and at project completion, a copy of the signed notice of termination (NOT) to the [MS4](#) upon their request. Permitting status of all permittees covered (or previously covered) under this general permit as well as the most current list of all [MS4](#) permits is available at the division's DataViewer web site<sup>2</sup>.

1.4.5. Permit Coverage through Qualifying Local Program

Coverage equivalent to coverage under this general permit may be obtained from a qualifying local erosion prevention and sediment control Municipal Separate Storm Sewer System ([MS4](#)) program. A qualifying local program (QLP) is a municipal stormwater program for stormwater discharges associated with construction activity that has been formally approved by the division. More information about Tennessee's QLP program and MS4 participants can be found at: <http://tn.gov/environment/wpc/stormh2o/qlp.shtml>.

If a construction site is within the jurisdiction of and has obtained a notice of coverage from a QLP, the [operator](#) of the construction activity is authorized to discharge stormwater associated with construction activity under this general permit without the submittal of an NOI to the division. The permittee is also not required to submit a [SWPPP](#), a notice of termination or a permit fee to the division. At the time of issuance of this permit, there were no qualifying local erosion prevention and sediment control [MS4](#) programs in Tennessee. Permitting of stormwater runoff from construction sites from federal or state agencies (including, but not limited to the Tennessee Department of Transportation (TDOT) and Tennessee Valley Authority (TVA)) and the local [MS4](#) program itself will remain solely under the authority of TDEC.

The division may require any owner/developer or [operator](#) located within the jurisdiction of a QLP to obtain permit coverage directly from the division. The [operator](#) shall be notified in writing by the division that coverage by the QLP is no longer applicable, and how to obtain coverage under this permit.

**1.5. Effective Date of Coverage**

1.5.1. Notice of Coverage (NOC)

The NOC is a notice from the division to the primary permittee, which informs the primary permittee that the NOI, the [SWPPP](#) and the appropriate fee were received and accepted, and stormwater discharges from a specified area of a construction activity have been approved under this general permit. The permittee is authorized to discharge stormwater associated with construction activity as of the effective date listed on the NOC.

Assigning a permit tracking number by the division to a proposed discharge from a construction site does not confirm or imply an authorization to discharge under this permit. Correspondence

---

<sup>2</sup> <http://www.tn.gov/environment/wpc/dataviewer/>



with the permittee is maintained through the Site Owner or Developer listed in the NOI, not the optional contact or the secondary permittee.

If any [Aquatic Resource Alteration Permits](#) (ARAP) are required for a site in areas proposed for active construction, the NOC will not be issued until ARAP application(s) are submitted and deemed by TDEC to be complete. The treatment and disposal of wastewater (including, but not limited to sanitary wastewater) generated during and after the construction must be also addressed. The issuance of the NOC may be delayed until adequate wastewater treatment and accompanying permits are issued.

#### 1.5.2. Permit tracking numbers

Construction sites covered under this permit will be assigned permit tracking numbers in the sequence TNR100001, TNR100002, etc. An [operator](#) presently permitted under a previous construction general permit shall be granted coverage under this new general permit. Permit tracking numbers assigned under a previous construction general permit will be retained (see section 2.4.1 below). An [operator](#) receiving new permit coverage will be assigned a new permit tracking number (see section 2.4.2 below).

## 2. NOTICE OF INTENT (NOI) REQUIREMENTS

### 2.1. Who Must Submit an NOI?

All site [operators](#) must submit an NOI form. “[Operator](#)” for the purpose of this permit and in the context of stormwater associated with construction activity means any person associated with a construction project who meets either or both of the following two criteria:

- a) The person has operational or design control over construction plans and specifications, including the ability to make modifications to those plans and specifications. This person is typically the owner or developer of the project or a portion of the project (e.g. subsequent builder), or the person that is the current land owner of the construction site. This person is considered the primary permittee; or
- b) The person has day-to-day operational control of those activities at a project which are necessary to ensure compliance with a [SWPPP](#) for the site or other permit conditions. This person is typically a contractor or a commercial builder who is hired by the primary permittee, and is considered a secondary permittee.

The site-wide permittee is the first primary permittee to apply for coverage at the site. There may be other primary permittees for a project, but there is only one site-wide permittee. Where there are multiple operators associated with the same project, all operators are required to obtain permit coverage. Once covered by a permit, all such operators are to be considered as co-permittees if their involvement in the construction activities affects the same project site, and are held jointly and severally responsible for complying with the permit.

## 2.2. Typical Construction Site Operators

### 2.2.1. Owner/Developer

An owner or developer(s) of a project is a primary permittee. This person has operational or design control over construction plans and specifications, including the ability to make modifications to those plans and specifications. This person may include, but is not limited to a developer, landowner, realtor, commercial builder, homebuilder, etc. An owner or developer's responsibility to comply with requirements of this permit extends until permit coverage is terminated in accordance with requirements of part 8 below.

### 2.2.2. Commercial builders

A commercial builder can be a primary or secondary permittee at a construction site.

A commercial builder who purchases one or more lots from an owner/developer (site-wide permittee) for the purpose of constructing and selling a structure (e.g., residential house, non-residential structure, commercial building, industrial facility, etc.) and has design or operational control over construction plans and specifications is a primary permittee for that portion of the site. A commercial builder may also be hired by the end user (e.g., a lot owner who may not be a permittee). In either case the commercial builder is considered a new [operator](#) and must submit a new NOI following requirements in section 2.4.3 below.

The commercial builder may also be hired by the primary permittee or a lot owner to build a structure. In this case, the commercial builder signs the primary permittee's NOI and [SWPPP](#) as a contractor (see section 2.2.3 below) and is considered a secondary permittee.

### 2.2.3. Contractors

A contractor is considered a secondary permittee. This person has day-to-day operational control of those activities at a project which are necessary to ensure compliance with a [SWPPP](#) for the site or other permit conditions (e.g., contractor is authorized to direct workers at a site to carry out activities required by the [SWPPP](#) or comply with other permit conditions).

A contractor may be, but is not limited to a general contractor, grading contractor, erosion control contractor, sub-contractor responsible for any land disturbing activities and/or erosion prevention and sediment control (EPSC) implementation/maintenance, commercial builder hired by the owner/developer, etc. The contractor may need to include in their contract with the party that hired them specific details for the contractor's responsibilities concerning EPSC measures. This includes the ability of the contractor to make EPSC modifications. The contractor should sign the NOI and [SWPPP](#) associated with the construction project at which they will be an operator.

## 2.3. Responsibilities of Operators

A permittee may meet one or more of the operational control components in the definition of "operator" found in subpart 2.1 above. Either section 2.3.1 or 2.3.2 below, or both, will apply depending on the type of operational control exerted by an individual permittee.

2.3.1. Permittee(s) with design control (owner/developer)

Permittee(s) with design control (i.e., operational control over construction plans and specifications) at the construction site, including the ability to make modifications to those plans and specifications (e.g., owner/developer) must:

- a) Ensure the project specifications they develop meet the minimum requirements of part 3 below (stormwater pollution prevention plan - [SWPPP](#)) and all other applicable conditions;
- b) Ensure that the [SWPPP](#) indicates the areas of the project where they have design control (including the ability to make modifications in specifications), and ensure all other permittees implementing and maintaining portions of the [SWPPP](#) impacted by any changes they make to the plan are notified of such modifications in a timely manner;
- c) Ensure that all common facilities (i.e., sediment treatment basin and drainage structures) that are necessary for the prevention of erosion or control of sediment are maintained and effective until all construction is complete and all disturbed areas in the entire project are stabilized, unless permit coverage has been obtained and responsibility has been taken over by a new (replacement) owner/operator.
- d) If parties with day-to-day operational control of the construction site have not been identified at the time the comprehensive [SWPPP](#) is initially developed, the permittee with design control shall be considered to be the responsible person until such time the supplemental NOI is submitted, identifying the new [operator\(s\)](#) (see section 2.4.3 below). These new [operators](#) (e.g., general contractor, utilities contractors, sub-contractors, erosion control contractors, hired commercial builders) are considered secondary permittees. The [SWPPP](#) must be updated to reflect the addition of new [operators](#) as needed to reflect operational or design control.
- e) Ensure that all [operators](#) on the site have permit coverage, if required, and are complying with the [SWPPP](#).

2.3.2. Permittee(s) with day-to-day operational control (contractor – secondary permittee)

Permittee(s) with day-to-day operational control of those activities at a project which are necessary to ensure compliance with the [SWPPP](#) for the site or other permit conditions (e.g., general contractor, utilities contractors, sub-contractors, erosion control contractors, hired commercial builders) must:

- a) Ensure that the [SWPPP](#) for portions of the project where they are operators meets the minimum requirements of part 3 below (*SWPPP Requirements*) and identifies the parties responsible for implementation of control measures identified in the plan;
- b) Ensure that the [SWPPP](#) indicates areas of the project where they have operational control over day-to-day activities;
- c) Ensure that measures in the [SWPPP](#) are adequate to prevent erosion and control any sediment that may result from their earth disturbing activity;
- d) Permittees with operational control over only a portion of a larger construction project are responsible for compliance with all applicable terms and conditions of this permit as it relates to their activities on their portion of the construction site. This includes, but is not limited to, implementation of [Best Management Practices \(BMPs\)](#) and other controls required by the [SWPPP](#). Permittees shall ensure either directly or through coordination with other permittees, that their activities do not render another person's pollution control ineffective. All permittees must implement their portions of a comprehensive [SWPPP](#).

## 2.4. NOI Submittal

### 2.4.1. Existing site

An [operator](#) presently permitted under the 2005 construction general permit shall be granted coverage under this new general permit. There will be no additional fees associated with an extension of coverage for existing sites under the new permit. The division may, at its discretion, require permittees to confirm their intent to be covered under this new general permit following its effective date through submission of an updated NOI. Should the confirmation be required and is not received, coverage under the new general permit will be terminated. Should a site with terminated coverage be unstable or construction continues, a new NOI, [SWPPP](#) and an appropriate fee must be submitted.

### 2.4.2. Application for new permit coverage

Except as provided in section 2.4.3 below, [operators](#) must submit a complete NOI, [SWPPP](#) and an appropriate fee in accordance with the requirements described in subpart 1.4 above. The complete application should be submitted at least 30 days prior to commencement of construction activities. The permittee is authorized to discharge stormwater associated with construction activity as of the effective date listed on the NOC. The land disturbing activities shall not start until a NOC is prepared and written approval by the division staff is obtained according to subpart 1.5 above.

### 2.4.3. New operator

For stormwater discharges from construction sites or portions of the sites where the [operator](#) changes (new owner), or projects where an [operator](#) is added (new contractor) after the initial NOI and comprehensive [SWPPP](#) have been submitted, the supplemental (submitted by a new contractor) or additional (submitted by a new owner) NOI should be submitted as soon as practicable, and always before the new [operator](#) commences work at the site. The supplemental NOI must reference the project name and tracking number assigned to the primary permittee's NOI.

If the site under the control of the new owner is inactive and all areas disturbed are completely stabilized, the NOI may not need to be submitted immediately upon assuming operational control. However, the division should be notified if a new [operator](#) obtains operational control at a site, but commencement of construction under the direction of the [operator](#) at the site is going to be delayed.

If upon the sale or transfer of the site's ownership does not change the signatory requirements for the NOI (see section 7.7.1 below), but the site's owner or developer's company name has changed, a new, updated NOI should be submitted to the division within 30 days of the name change. If the new [operator](#) agrees to comply with an existing comprehensive [SWPPP](#) already implemented at the site, a copy of the supplemental or modified [SWPPP](#) does not have to be submitted with the NOI. There will be no additional fees associated with the sale or transfer of ownership for existing permitted sites.

If the transfer of ownership is due to foreclosure or a permittee filing for bankruptcy proceedings, the new owner (including but not limited to a lending institution) must obtain permit coverage if the property is inactive, but is not stabilized sufficiently. If the property is sufficiently stabilized permit coverage may not be necessary, unless and until construction activity at the site resumes.

#### 2.4.4. Late NOIs

Dischargers are not prohibited from submitting late NOIs. When a late NOI is submitted, and if the division authorizes coverage under this permit, such authorization is only for future discharges; any prior, unpermitted, discharges or permit noncompliances are subject to penalties as described in section 7.1.2 below.

### 2.5. **Who Must Sign the NOI?**

All construction site [operators](#) as defined in subsection 2.2 above (*Typical Construction Site Operators*) must sign the NOI form. Signatory requirements for a NOI are described in section 7.7.1 below. All signatures must be original. An NOI that does not bear an original signature will be deemed incomplete. The division recommends that signatures be in blue ink.

### 2.6. **NOI Form**

#### 2.6.1. Contents of the NOI form

NOI for construction projects shall be submitted on the form provided in Appendix A of this permit, or on a copy thereof. This form and its instructions set forth the required content of the NOI. The NOI form must be filled in completely. If sections of the NOI are left blank, a narrative explaining the omission must be provided as an attachment.

Owners, developers and all contractors that meet the definition of the [operator](#) in subsection 2.2 above (*Typical Construction Site Operators*) shall apply for permit coverage on the same NOI, insofar as possible. The NOI is designed for more than one contractor (secondary permittee). The division may accept separate NOI forms from different [operators](#) for the same construction site when warranted.

After permit coverage has been granted to the primary permittee, any subsequent NOI submittals must include the site's previously assigned permit tracking number and the project name. The comprehensive site-specific [SWPPP](#) shall be prepared in accordance with the requirements of part 3 below, and must be submitted with the NOI unless the NOI being submitted is to only add a contractor (secondary permittee) to an existing coverage.

#### 2.6.2. Construction site map

An excerpt (8 ½" by 11" or 11" by 17") from the appropriate 7.5 minute [United States Geological Survey](#) (USGS) topographic map, with the proposed construction site centered, must be included with the NOI. The entire proposed construction area must be clearly identified (outlined) on this map. The total area to be disturbed (in acres) should be included on the map. The map should outline the boundaries of projects, developments and the construction site in relation to major roads, streams or other landmarks. All outfalls where runoff will leave the property should be identified. Stream(s) receiving the discharge, and storm sewer system(s)

conveying the discharge from all site outfalls should be clearly identified and marked on the map. The map should also list and indicate the location of EPSCs that will be used at the construction site. NOIs for [linear projects](#) must specify the location of each end of the construction area and all areas to be disturbed. Commercial builders that develop separate [SWPPPs](#) that cover only their portion of the project shall also submit a site or plat map that clearly indicates the lots which they purchased and for which they are applying for permit coverage and the location of EPSCs that will be used at each lot.

2.6.3. Application completeness

Based on a review of the NOI or other available information, the division shall:

1. prepare a notice of coverage (NOC) for the construction site (see subpart 1.5 above); or
2. prepare a deficiency letter stating additional information must be provided before the NOC can be issued; or
3. deny coverage under this general permit and require the discharger to obtain coverage under an individual NPDES permit (see subpart 7.12 below).

**2.7. Where to Submit the NOI, SWPPP and Permitting Fee?**

The applicant shall submit the NOI, [SWPPP](#) and permitting fee to the appropriate TDEC Environmental Field Office (EFO) for the county(ies) where the construction activity is located and where stormwater discharges enters [waters of the state](#). If a site straddles a county line of counties that are in areas of different EFOs, the [operators](#) shall send NOIs to each EFO. The permitting fee should be submitted to the EFO that provides coverage for the majority of the proposed construction activity.

A list of counties and the corresponding EFOs is provided in subpart 2.8 below. The division’s Nashville Central Office will serve as a processing office for NOIs submitted by federal or state agencies (including, but not limited to the Tennessee Department of Transportation (TDOT), Tennessee Valley Authority (TVA) and the local [MS4](#) programs).

**2.8. List of the TDEC Environmental Field Offices (EFOs) and Corresponding Counties**

<a href="#">EFO Name</a>	List of Counties
<a href="#">Chattanooga</a>	Bledsoe, Bradley, Grundy, Hamilton, Marion, McMinn, Meigs, Polk, Rhea, Sequatchie
<a href="#">Columbia</a>	Bedford, Coffee, Franklin, Giles, Hickman, Lawrence, Lewis, Lincoln, Marshall, Maury, Moore, Perry, Wayne
<a href="#">Cookeville</a>	Cannon, Clay, Cumberland, De Kalb, Fentress, Jackson, Macon, Overton, Pickett, Putnam, Smith, Van Buren, Warren, White
<a href="#">Jackson</a>	Benton, Carroll, Chester, Crockett, Decatur, Dyer, Gibson, Hardeman, Hardin, Haywood, Henderson, Henry, Lake, Lauderdale, Madison, McNairy, Obion, Weakley
<a href="#">Johnson City</a>	Carter, Greene, Hancock, Hawkins, Johnson, Sullivan, Unicoi, Washington
<a href="#">Knoxville</a>	Anderson, Blount, Campbell, Claiborne, Cocke, Grainger, Hamblen, Jefferson, Knox, Loudon, Monroe, Morgan, Roane, Scott, Sevier, Union
<a href="#">Memphis</a>	Fayette, Shelby, Tipton
<a href="#">Nashville</a>	Cheatham, Davidson, Dickson, Houston, Humphreys, Montgomery, Robertson, Rutherford, Stewart, Sumner, Trousdale, Williamson, Wilson



TDEC may be reached by telephone at the toll-free number 1-888-891-8332 (TDEC). Local EFOs may be reached directly when calling this number from the construction site, using a land line.

### **3. STORMWATER POLLUTION PREVENTION PLAN (SWPPP) REQUIREMENTS**

#### **3.1. The General Purpose of the SWPPP**

A comprehensive [SWPPP](#) must be prepared and submitted along with the NOI as required in section 1.4.2 above. The primary permittee must implement the [SWPPP](#) as written from commencement of construction activity until final stabilization is complete, or until the permittee does not have design or operational control of any portion of the construction site. Requirements for termination of site coverage are provided in part 8 below.

A site-specific [SWPPP](#) must be developed for each construction project or site covered by this permit. The design, inspection and maintenance of [Best Management Practices \(BMPs\)](#) described in [SWPPP](#) must be prepared in accordance with good engineering practices. At a minimum, [BMPs](#) shall be consistent with the requirements and recommendations contained in the current edition of the [Tennessee Erosion and Sediment Control Handbook](#) (the handbook). The handbook is designed to provide information to planners, developers, engineers, and contractors on the proper selection, installation, and maintenance of [BMPs](#). This permit allows the use of innovative or alternative [BMPs](#), whose performance has been documented to be equivalent or superior to conventional [BMPs](#) as certified by the [SWPPP](#) designer.

Once a definable area has been finally stabilized, the permittee may identify this area on the site-specific [SWPPP](#). No further [SWPPP](#) or inspection requirements apply to that portion of the site (e.g., earth-disturbing activities around one of three buildings in a complex are done and the area is finally stabilized, one mile of a roadway or pipeline project is done and finally stabilized, etc).

For more effective coordination of [BMPs](#) a cooperative effort by the different [operators](#) at a site to prepare and participate in a comprehensive [SWPPP](#) is expected. Primary permittees at a site may develop separate [SWPPPs](#) that cover only their portion of the project. In instances where there is more than one [SWPPP](#) for a site, the permittees must ensure the stormwater discharge controls and other measures are compatible with one another and do not prevent another [operator](#) from complying with permit conditions. The comprehensive [SWPPP](#) developed and submitted by the primary permittee must assign responsibilities to subsequent (secondary) permittees and coordinate all [BMPs](#) at the construction site. Assignment and coordination can be done by name or by job title.

##### **3.1.1. Registered engineer or landscape architect requirement**

The narrative portion of the [SWPPP](#) may be prepared by an individual that has a working knowledge of erosion prevention and sediment controls, such as a Certified Professional in Erosion and Sediment Control ([CPESC](#)) or a person that successfully completed the “[Level II Design Principles for Erosion Prevention and Sediment Control for Construction Sites](#)” course. Plans and specifications for any building or structure, including the design of sediment basins or other sediment controls involving structural, hydraulic, hydrologic or other engineering calculations shall be prepared by a licensed professional engineer or landscape architect and

stamped and certified in accordance with the [Tennessee Code Annotated](#), Title 62, Chapter 2 (see part 10 below) and the rules of the [Tennessee Board of Architectural and Engineering Examiners](#). Engineering design of sediment basins and other sediment controls must be included in SWPPPs for construction sites involving drainage to an outfall totaling 10 or more acres (see subsection 3.5.3.3 below) or 5 or more acres if draining to an impaired or exceptional quality waters (see subsection 5.4.1 below).

### 3.1.2. Site Assessment

Quality assurance of erosion prevention and sediment controls shall be done by performing site assessment at a construction site. The site assessment shall be conducted at each outfall involving drainage totaling 10 or more acres (see subsection 3.5.3.3 below) or 5 or more acres if draining to an impaired or exceptional quality waters (see subsection 5.4.1 below), within a month of construction commencing at each portion of the site that drains the qualifying acreage of such portion of the site. The site assessment shall be performed by individuals with following qualifications:

- a licensed professional engineer or landscape architect;
- a Certified Professional in Erosion and Sediment Control ([CPESC](#)) or
- a person that successfully completed the “[Level II Design Principles for Erosion Prevention and Sediment Control for Construction Sites](#)” course.

As a minimum, site assessment should be performed to verify the installation, functionality and performance of the EPSC measures described in the SWPPP. The site assessment should be performed with the inspector (as defined in part 10 below – Definitions), and should include a review and update (if applicable) of the SWPPP. Modifications of plans and specifications for any building or structure, including the design of sediment basins or other sediment controls involving structural, hydraulic, hydrologic or other engineering calculations shall be prepared by a licensed professional engineer or landscape architect and stamped and certified in accordance with the [Tennessee Code Annotated](#), Title 62, Chapter 2 (see part 10 below) and the rules of the [Tennessee Board of Architectural and Engineering Examiners](#).

The site assessment findings shall be documented and the documentation kept with the SWPPP at the site. At a minimum, the documentation shall include information included in the inspection form provided in Appendix C of this permit. The documentation must contain the printed name and signature of the individual performing the site assessment and the following certification:

*“I certify under penalty of law that this report and all attachments are, to the best of my knowledge and belief, true, accurate, and complete. I am aware that there are significant penalties for submitting false information, including the possibility of fine and imprisonment for knowing violations.”*

The site assessment can take the place of one of the twice weekly inspections requirement from subsection 3.5.8.2 below.

The division may require additional site assessment(s) to be performed if site inspection by division’s personnel reveals site conditions that have potential of causing pollution to the [waters of the state](#).

### **3.2. SWPPP Preparation and Compliance**

#### **3.2.1. Existing site**

Operator(s) of an existing site presently permitted under the division's previous construction general permit shall maintain full compliance with the current SWPPP. The current SWPPP should be modified, if necessary, to meet requirements of this new general permit, and the SWPPP changes implemented no later than 12 months following the new permit effective date (May 24, 2011), excluding the buffer zone requirements as stated in section 4.1.2 below. The permittee shall make the updated SWPPP available for the division's review upon request.

#### **3.2.2. New site**

For construction stormwater discharges not authorized under an NPDES permit as of the effective date of this permit, a SWPPP that meets the requirements of subpart 3.5 below of this permit shall be prepared and submitted along with the NOI and an appropriate fee for coverage under this permit.

### **3.3. Signature Requirements, Plan Review and Making Plans Available**

#### **3.3.1. Signature Requirements for a SWPPP**

The SWPPP shall be signed by the operator(s) in accordance with subpart 7.7 below, and if applicable, certified according to requirements in section 3.1.1 above. All signatures must be original. A SWPPP that does not bear an original signature will be deemed incomplete. The division recommends that signatures be in blue ink.

#### **3.3.2. SWPPP Review**

The permittee shall make updated plans and inspection reports available upon request to the director, local agency approving erosion prevention and sediment control plan, grading plans, land disturbance plans, or stormwater management plans, or the operator of an MS4.

#### **3.3.3. Making plans available**

A copy of the SWPPP shall be retained on-site at the location which generates the stormwater discharge in accordance with part 6 below of this permit. If the site is inactive or does not have an onsite location adequate to store the SWPPP, the location of the SWPPP, along with a contact phone number, shall be posted on-site. If the SWPPP is located offsite, reasonable local access to the plan, during normal working hours, must be provided.

### **3.4. Keeping Plans Current**

#### **3.4.1. SWPPP modifications**

The permittee must modify and update the SWPPP if any of the following are met:

- a) whenever there is a change in the scope of the project, which would be expected to have a significant effect on the discharge of pollutants to the waters of the state and which has

- not otherwise been addressed in the [SWPPP](#). If applicable, the SWPPP must be modified or updated whenever there is a change in chemical treatment methods, including the use of different treatment chemical, different dosage or application rate, or different area of application;
- b) whenever inspections or investigations by site [operators](#), local, state or federal officials indicate the [SWPPP](#) is proving ineffective in eliminating or significantly minimizing pollutants from sources identified under section 3.5.2 below of this permit, or is otherwise not achieving the general objectives of controlling pollutants in stormwater discharges associated with construction activity. Where local, state or federal officials determine that the SWPPP is ineffective in eliminating or significantly minimizing pollutant sources, a copy of any correspondence to that effect must be retained in the SWPPP;
  - c) to identify any new [operator](#) (typically contractor and/or subcontractor) as needed to reflect operational or design control that will implement a measure of the [SWPPP](#) (see subparts 2.1 and 2.2 above for further description of which [operators](#) must be identified); and
  - d) to include measures necessary to prevent a negative impact to legally protected state or federally listed fauna or flora (or species proposed for such protection – see subpart 1.3 above). Amendments to the [SWPPP](#) may be reviewed by the division, a local [MS4](#), the EPA or an authorized regulatory agency; and
  - e) a TMDL is developed for the receiving waters for a pollutant of concern (siltation and/or habitat alteration).

### **3.5. Components of the SWPPP**

The [SWPPP](#) shall include the following items, as described in sections 3.5.1 to 3.5.10 below: site description, description of stormwater runoff controls, erosion prevention and sediment controls, stormwater management, description of other items needing control, approved local government sediment and erosion control requirements, maintenance, inspections, pollution prevention measures for non-stormwater discharges, and documentation of permit eligibility related to Total Maximum Daily Loads ([TMDL](#)). The [SWPPP](#) must:

- a) identify all potential sources of pollution which are likely to affect the quality of stormwater discharges from the construction site;
- b) describe practices to be used to reduce pollutants in stormwater discharges from the construction site; and
- c) assure compliance with the terms and conditions of this permit.

#### **3.5.1. Site description**

Each plan shall provide a description of pollutant sources and other information as indicated below:

- a) a description of all construction activities at the site (not just grading and street construction);
- b) the intended sequence of major activities which disturb soils for major portions of the site (e.g., grubbing, excavation, grading, utilities and infrastructure installation, etc.);
- c) estimates of the total area of the site and the total area that is expected to be disturbed by excavation, grading, filling, or other construction activities;

- d) a description of the topography of the site including an estimation of the percent slope and the variation in percent slope found on the site; such estimation should be on a basis of a drainage area serving each outfall, rather than an entire project;
- e) any data describing the soil (data may be referenced or summarized) and how the soil type will dictate the needed control measures and how the soil may affect the expected quality of runoff from the site;
- f) an estimate of the runoff coefficient of the site after construction activities are completed and how the runoff will be handled to prevent erosion at the permanent outfall and receiving stream, as well as the estimate of the percentage of impervious area before and after construction;
- g) an erosion prevention and sediment control plan of the site with the proposed construction area clearly outlined. The plan should indicate the boundaries of the permitted area, drainage patterns and approximate slopes anticipated after major grading activities, areas of soil disturbance, an outline of areas which are not to be disturbed, the location of major structural and nonstructural controls identified in the [SWPPP](#), the location of areas where stabilization practices are expected to occur, surface waters including wetlands, sinkholes, and careful identification on the site plan of outfall points intended for coverage under the general permit for stormwater discharges from the site. The erosion control plan must meet requirements stated in section 3.5.2 below;
- h) a description of any discharge associated with industrial activity other than construction stormwater that originates on site and the location of that activity and its permit number;
- i) identification of any stream or wetland on or adjacent to the project, a description of any anticipated alteration of these waters and the permit number or the tracking number of the [Aquatic Resources Alteration Permit](#) (ARAP) or Section 401 Certification issued for the alteration;
- j) the name of the receiving water(s), and approximate size and location of affected wetland acreage at the site;
- k) if applicable, clearly identify and outline the [buffer zones](#) established to protect [waters of the state](#) located within the boundaries of the project;
- l) some construction projects, such as residential or commercial subdivisions and/or developments or industrial parks are subdivided. Subdivided lots are sometimes sold to new owners prior to completion of construction. The site-wide developer/owner must describe EPSC measures implemented at those lots. Once the property is sold, the new operator must obtain coverage under this permit;
- m) for projects of more than 50 acres, the construction phases must be described (see subsection 3.5.3.1 below); and
- n) if only a portion of the total acreage of the construction site is to be disturbed, then the protections employed to limit the disturbance must be discussed, i.e., caution fence, stream side [buffer zones](#), etc. Limits of disturbance shall be clearly marked in the [SWPPP](#) and areas to be undisturbed clearly marked in the field before construction activities begin.

### 3.5.2. Description of stormwater runoff controls

The [SWPPP](#) shall include a description of appropriate erosion prevention and sediment controls and other [Best Management Practices \(BMPs\)](#) that will be implemented at the construction site. The [SWPPP](#) must clearly describe each major activity which disturbs soils for major portions of the site (e.g., grubbing, excavation, grading, utilities and infrastructure installation, etc.):

- a) appropriate control measures and the general timing for the measures to be implemented during construction activities; and
- b) which permittee is responsible for implementation of which controls.

The [SWPPP](#) must include erosion prevention and sediment control (EPSC) plans showing the approximate location of each control measure along with a description of the timing during the construction process for implementing each measure (e.g., prior to the start of earth disturbance, as the slopes are altered and after major grading is finished). The different stages of construction (initial/major grading, installation of infrastructure, final contours, etc.) and the erosion preventions and sediment control measures that will be utilized during each stage should be depicted on multiple plan sheets (see paragraphs below). Half sheets are acceptable. One sheet showing all EPSCs that will be used during the life of the multi-phase project implementing different EPSC controls at each stage will not be considered complete.

For site disturbances less than 5 acres, at least two separate EPSC plan sheets shall be developed. At least two stages shall be identified, with associated EPSC measures addressed. The plan stages shall be addressed separately in plan sheets, with each stage reflecting the conditions and EPSC measures necessary to manage stormwater runoff, erosion and sediment during the initial land disturbance (initial grading) and the conditions and EPSC measures necessary to manage stormwater, erosion and sediment at final grading.

For site disturbances more than 5 acres, at least 3 separate EPSC plan sheets shall be developed. Three stages shall be identified. The first plan sheet should reflect the conditions and EPSC measures necessary to manage stormwater runoff, during the initial land disturbance (initial grading). The second plan sheet shall reflect the conditions and the EPSC measures necessary to manage stormwater runoff from interim land disturbance activities. The third plan sheet shall reflect the conditions and EPSC measures necessary to manage stormwater runoff, erosion and sediment at final grading.

The description and implementation of controls shall address the following minimum components, as described in sections 3.5.3, 3.5.4 and 3.5.5 below. Additional controls may be necessary to comply with section 5.3.2 below.

### 3.5.3. Erosion prevention and sediment controls

#### 3.5.3.1. General criteria and requirements

- a) The construction-phase erosion prevention controls shall be designed to eliminate (or minimize if complete elimination is not possible) the dislodging and suspension of soil in water. Sediment controls shall be designed to retain mobilized sediment on site to the maximum extent practicable.
- b) The design, inspection and maintenance of [Best Management Practices \(BMPs\)](#) described in [SWPPP](#) must be prepared in accordance with good engineering practices and, at a minimum, shall be consistent with the requirements and recommendations contained in the current edition of the [Tennessee Erosion and Sediment Control Handbook](#). In addition, all control measures must be properly selected, installed, and maintained in accordance with the manufacturer's specifications (where applicable). All control measures selected must be able to slow runoff so that rill and gully formation is prevented. When [steep slopes](#) and/or fine particle soils are present at the site, additional physical or chemical treatment of stormwater runoff may be required. Proposed physical



and/or chemical treatment must be researched and applied according to the manufacturer's guidelines and fully described in the SWPPP. If periodic inspections or other information indicates a control has been used inappropriately, or incorrectly, the permittee must replace or modify the control for relevant site situations.

- c) If permanent or temporary vegetation is to be used as a control measure, then the timing of the planting of the vegetation cover must be discussed in the SWPPP. Planning for planting cover vegetation during winter months or dry months should be avoided.
- d) If sediment escapes the permitted area, off-site accumulations of sediment that have not reached a stream must be removed at a frequency sufficient to minimize offsite impacts (e.g., fugitive sediment that has escaped the construction site and has collected in a street must be removed so that it is not subsequently washed into storm sewers and streams by the next rain and/or so that it does not pose a safety hazard to users of public streets). Permittees shall not initiate remediation/restoration of a stream without consulting the division first. This permit does not authorize access to private property. Arrangements concerning removal of sediment on adjoining property must be settled by the permittee with the adjoining landowner.
- e) Sediment should be removed from sediment traps, silt fences, sedimentation ponds, and other sediment controls as recommended in the [Tennessee Erosion and Sediment Control Handbook](#), and must be removed when design capacity has been reduced by 50%.
- f) Litter, construction debris, and construction chemicals exposed to stormwater shall be picked up prior to anticipated storm events or before being carried off of the site by wind (e.g., forecasted by local weather reports), or otherwise prevented from becoming a pollutant source for stormwater discharges (e.g., screening outfalls, daily pick-up, etc.). After use, materials used for erosion prevention and sediment control (such as silt fence) should be removed or otherwise prevented from becoming a pollutant source for stormwater discharges.
- g) Erodeable material storage areas (including but not limited to overburden and stockpiles of soil etc.) and borrow pits used primarily for the permitted project and which are contiguous to the site are considered a part of the site and shall be identified on the NOI, addressed in the SWPPP and included in the fee calculation. TDOT projects shall be addressed in the [Waste and Borrow Manual](#) per the [Statewide Stormwater Management Plan \(SSWMP\)](#).
- h) Pre-construction vegetative ground cover shall not be destroyed, removed or disturbed more than 15 days prior to grading or earth moving unless the area is seeded and/or mulched or other temporary cover is installed.
- i) Clearing and grubbing must be held to the minimum necessary for grading and equipment operation. Existing vegetation at the site should be preserved to the maximum extent practicable.
- j) Construction must be sequenced to minimize the exposure time of graded or denuded areas.
- k) Construction phasing is required on all projects regardless of size as a major practice for minimizing erosion and limiting sedimentation. Construction must be phased to keep the total disturbed area less than 50 acres at any one time. Areas of the completed phase must be stabilized within 14 days (see subsection 3.5.3.2 below). No more than 50 acres of active soil disturbance is allowed at any time during the construction project. This includes off-site borrow or disposal areas that meet the conditions of section 1.2.2 above of this general permit.

The 50 acre limitation does not apply to [linear construction projects](#) (such as roadway, pipeline, and other infrastructure construction activities) if the following conditions are met:

- Where no one area of active soil disturbance is greater than 50 acres and the various areas of disturbance have distinct receiving waters; or
- Where contiguous disturbances amount to greater than 50 acres, but no one distinct water is receiving run off from more than 50 disturbed acres; or
- With the department's written concurrence, where more than 50 acres of disturbance is to occur and where one receiving water will receive run-off from more than 50 acres; or
- Where no one area of active soil disturbance is greater than 50 acres and the various areas of disturbance are more than 5 miles apart.

In order for a [linear project](#) to take advantage of the 50 acre rule exemption outlined in this paragraph, the contractor shall conduct monthly site assessments as described in section 3.1.2 above until the site is permanently stabilized.

- l) Erosion prevention and sediment control measures must be in place and functional before earth moving operations begin, and must be constructed and maintained throughout the construction period. Temporary measures may be removed at the beginning of the workday, but must be replaced at the end of the workday.
- m) The following records shall be maintained on or near site: the dates when major grading activities occur; the dates when construction activities temporarily or permanently cease on a portion of the site; the dates when stabilization measures are initiated; inspection records and rainfall records.
- n) Off-site vehicle tracking of sediments and the generation of dust shall be minimized. A stabilized construction access (a point of entrance/exit to a construction site) shall be described and implemented, as needed, to reduce the tracking of mud and dirt onto public roads by construction vehicles.
- o) Permittees shall maintain a rain gauge and daily rainfall records at the site, or use a reference site for a record of daily amount of precipitation.

#### 3.5.3.2. Stabilization practices

The [SWPPP](#) shall include a description of interim and permanent stabilization practices, including site-specific scheduling of the implementation of the practices. Site plans should ensure that existing vegetation is preserved where attainable and that disturbed portions of the site are stabilized. Site plans should comply with [buffer zone](#) requirements (see sections 4.1.2 and 5.4.2 below), if applicable, in which construction activities, borrow and/or fill are prohibited. Stabilization practices may include: temporary seeding, permanent seeding, mulching, geotextiles, sod stabilization, vegetative buffer strips, protection of trees, preservation of mature vegetation, and other appropriate measures. Use of impervious surfaces for final stabilization in lieu of a permanent vegetative cover should be avoided where practicable. No stabilization, erosion prevention and sediment control measures are to be installed in a stream without obtaining a Section 404 permit and an [Aquatic Resources Alteration Permit](#) (ARAP), if such permits are required and appropriate.

Stabilization measures shall be initiated as soon as possible in portions of the site where construction activities have temporarily or permanently ceased. Temporary or permanent soil stabilization at the construction site (or a phase of the project) must be completed no later than 14 days after the construction activity in that portion of the site has temporarily or permanently ceased. In the following situations, [temporary stabilization](#) measures are not required:

- a) where the initiation of stabilization measures is precluded by snow cover or frozen ground conditions or adverse soggy ground conditions, stabilization measures shall be initiated as soon as practicable; or
- b) where construction activity on a portion of the site is temporarily ceased, and earth disturbing activities will be resumed within 14 days.

[Steep slopes](#) shall be temporarily stabilized not later than 7 days after construction activity on the slope has temporarily or permanently ceased.

Permanent stabilization with perennial vegetation (using native herbaceous and woody plants where practicable) or other permanently stable, non-eroding surface shall replace any temporary measures as soon as practicable. Unpacked gravel containing fines (silt and clay sized particles) or crusher runs will not be considered a non-eroding surface.

#### 3.5.3.3. Structural practices

The [SWPPP](#) shall include a description of structural practices to divert flows from exposed soils, store flows or otherwise limit runoff and discharge of pollutants from exposed areas of the site. Such practices may include silt fences, earth dikes, drainage swales, sediment traps, check dams, subsurface drains, pipe slope drains, level spreaders, storm drain inlet protection, rock outlet protection, reinforced soil retaining systems, gabions, and temporary or permanent sediment basins. Structural controls shall not be placed in streams or wetlands except as authorized by a section 404 permit and/or [Aquatic Resources Alteration Permit](#) (ARAP).

Erosion prevention and sediment control measures must be prepared in accordance with good engineering practices and the latest edition of the [Tennessee Erosion and Sediment Control Handbook](#). In addition, erosion prevention and sediment controls shall be designed to minimize erosion and maximize sediment removal resulting from a [2-year, 24-hour storm](#) (the design storm – see part 10 below: “2-year and 5-year design storm depths and intensities”), as a minimum, either from total rainfall in the designated period or the equivalent intensity as specified on the following website [http://hdsc.nws.noaa.gov/hdsc/pfds/orb/tn\\_pfds.html](http://hdsc.nws.noaa.gov/hdsc/pfds/orb/tn_pfds.html). When clay and other fine particle soils are present at the construction site, chemical treatment may be used to minimize amount of sediment being discharged.

For an on-site outfall which receives drainage from 10 or more acres, a minimum sediment basin volume that will provide treatment for a calculated volume of runoff from a [2 year, 24 hour storm](#) and runoff from each acre drained, or equivalent control measures as specified in the [Tennessee Erosion and Sediment Control Handbook](#), shall be provided until final stabilization of the site. A drainage area of 10 or more acres includes both disturbed and undisturbed portions of the site or areas adjacent to the site, all draining through the common outfall. Where an equivalent control measure is substituted for a sediment retention basin, the equivalency must be justified to the division. Runoff from any undisturbed acreage should be diverted around the disturbed area and the sediment basin. Diverted runoff can be omitted from the volume calculation. Sediment storage expected from the disturbed areas must be included.

All calculations of drainage areas, runoff coefficients and basin volumes must be provided in the [SWPPP](#). The discharge structure from a sediment basin must be designed to retain sediment during the lower flows. Muddy water to be pumped from excavation and work areas must be held in settling basins or filtered or chemically treated prior to its discharge into surface waters. Water must be discharged through a pipe, well-grassed or lined channel or other equivalent means so that the discharge does not cause erosion and sedimentation. Discharged water must not cause an objectionable color contrast with the receiving stream.

#### 3.5.4. Stormwater management

The [SWPPP](#) shall include a description of any measures that will be installed during the construction process to control pollutants in stormwater discharges that will occur after construction operations have been completed.

For projects discharging to waters considered impaired by sediment or habitat alteration due to in-channel erosion, the [SWPPP](#) shall include a description of measures that will be installed during the construction process to control pollutants and any increase in the volume of stormwater discharges that will occur after construction operations have been completed. For [steep slope](#) sites, the [SWPPP](#) shall also include a description of measures that will be installed to dissipate the volume and energy of the stormwater runoff to pre-development levels.

This permit only addresses the installation of stormwater management measures, and not the ultimate operation and maintenance of such structures after the construction activities have been completed, the site has undergone final stabilization, and the permit coverage has been terminated. Permittees are only responsible for the installation and maintenance of stormwater management measures prior to final stabilization of the site, and are not responsible for maintenance after stormwater discharges associated with construction activity have been eliminated from the site. All permittees are encouraged to limit the amount of post construction runoff, if not required by local building regulations or local [MS4](#) program requirements, in order to minimize in-stream channel erosion in the receiving stream.

Construction stormwater runoff management practices may include: stormwater detention structures (including ponds with a permanent pool); stormwater retention structures; flow attenuation by use of open vegetated swales and natural depressions; infiltration of runoff onsite; and sequential systems (which combine several practices).

Velocity dissipation devices shall be placed at discharge locations and along the length of any outfall channel to provide a non-erosive velocity flow from the structure to the receiving stream so that the natural physical and biological characteristics and functions of the stream are maintained and protected (e.g., there should be no significant changes in the hydrological regime of the receiving water). The [SWPPP](#) shall include an explanation of the technical basis used to select the velocity dissipation devices to control pollution where flows exceed pre-development levels. The [Tennessee Erosion and Sediment Control Handbook](#) provides measures that can be incorporated into the design or implemented on site to decrease erosive velocities. An [Aquatic Resources Alteration Permit](#) (ARAP) may be required if such velocity dissipation devices installed would alter the receiving stream and/or its banks.

3.5.5. Other items needing control

- a) No solid materials, including building materials, shall be placed in [waters of the state](#), except as authorized by a section 404 permit and/or [Aquatic Resources Alteration Permit \(ARAP\)](#)(see part 9 below).
- b) For installation of any waste disposal systems on site, or sanitary sewer or septic system, the [SWPPP](#) shall identify these systems and provide for the necessary EPSC controls. Permittees must also comply with applicable state and/or local waste disposal, sanitary sewer or septic system regulations for such systems to the extent these are located within the permitted area.
- c) The [SWPPP](#) shall include a description of construction and waste materials expected to be stored on-site. The [SWPPP](#) shall also include a description of controls used to reduce pollutants from materials stored on site, including storage practices to minimize exposure of the materials to stormwater, and spill prevention and response.
- d) A description of stormwater sources from areas other than construction and a description of controls and measures that will be implemented at those sites.
- e) A description of measures necessary to prevent “taking” of legally protected state or federal listed threatened or endangered aquatic fauna and/or critical habitat (if applicable). The permittee must describe and implement such measures to maintain eligibility for coverage under this permit.

3.5.6. Approved local government sediment and erosion control requirements

Permittees must comply with any additional erosion prevention, sediment controls and stormwater management measures required by a local municipality or permitted [MS4](#) program.

3.5.7. Maintenance

The [SWPPP](#) shall describe procedures to ensure that vegetation, erosion and sediment control measures, [buffer zones](#), and other protective measures identified in the site plan are kept in good and effective operating condition. Maintenance needs identified in inspections or by other means shall be accomplished before the next storm event, but in no case more than 7 days after the need is identified.

3.5.8. Inspections

3.5.8.1. Inspector training and certification

Inspectors performing the required twice weekly inspections must have an active certification by completing the “[Fundamentals of Erosion Prevention and Sediment Control Level I](#)” course. A copy of the certification or training record for inspector certification should be kept on site.

3.5.8.2. Schedule of inspections

- a) Inspections described in paragraphs b, c and d below, shall be performed at least twice every calendar week. Inspections shall be performed at least 72 hours apart. Where sites or portion(s) of construction sites have been temporarily stabilized, or runoff is unlikely due to winter conditions (e.g., site covered with snow or ice) or due to extreme drought, such inspection only has to be conducted once per month until thawing or precipitation results in runoff or construction activity resumes. Inspection requirements do not apply

- to definable areas that have been finally stabilized, as described in subpart 3.1 above. Written notification of the intent to change the inspection frequency and the justification for such request must be submitted to the local Environmental Field Office, or the division's Nashville Central Office for projects of the Tennessee Department of Transportation (TDOT) and the Tennessee Valley Authority (TVA). Should the division discover that monthly inspections of the site are not appropriate due to insufficient stabilization measures or otherwise, twice weekly inspections shall resume. The division may inspect the site to confirm or deny the notification to conduct monthly inspections.
- b) Qualified personnel, as defined in section 3.5.8.1 above (provided by the permittee or cooperatively by multiple permittees) shall inspect disturbed areas of the construction site that have not been finally stabilized, areas used for storage of materials that are exposed to precipitation, structural control measures, locations where vehicles enter or exit the site, and each outfall.
  - c) Disturbed areas and areas used for storage of materials that are exposed to precipitation shall be inspected for evidence of, or the potential for, pollutants entering the site's drainage system. Erosion prevention and sediment control measures shall be observed to ensure that they are operating correctly.
  - d) Outfall points (where discharges leave the site and/or enter [waters of the state](#)) shall be inspected to determine whether erosion prevention and sediment control measures are effective in preventing significant impacts to receiving waters. Where discharge locations are inaccessible, nearby downstream locations shall be inspected. Locations where vehicles enter or exit the site shall be inspected for evidence of offsite sediment tracking.
  - e) Based on the results of the inspection, any inadequate control measures or control measures in disrepair shall be replaced or modified, or repaired as necessary, before the next rain event, but in no case more than 7 days after the need is identified.
  - f) Based on the results of the inspection, the site description identified in the [SWPPP](#) in accordance with section 3.5.1 above and pollution prevention measures identified in the [SWPPP](#) in accordance with section 3.5.2 above shall be revised as appropriate, but in no case later than 7 days following the inspection. Such modifications shall provide for timely implementation of any changes to the [SWPPP](#), but in no case later than 14 days following the inspection.
  - g) All inspections shall be documented on the Construction Stormwater Inspection Certification form provided in Appendix C of this permit for all construction sites. An alternative inspection form may be used as long as the form contents and the inspection certification language are, at a minimum, equivalent to the division's form (Appendix C) and the permittee has obtained a written approval from the division to use the alternative form. Inspection documentation will be maintained on site and made available to the division upon request. Inspection reports must be submitted to the division within 10 days of the request. If the division requests the Construction Stormwater Inspection Certification form to be submitted, the submitted form must contain the printed name and signature of the trained certified inspector and the person who meets the signatory requirements of section 7.7.2 below of this permit.
  - h) Trained certified inspectors shall complete inspection documentation to the best of their ability. Falsifying inspection records or other documentation or failure to complete inspection documentation shall result in a violation of this permit and any other applicable acts or rules.
  - i) Subsequent [operator\(s\)](#) (primary permittees) who have obtained coverage under this permit should conduct twice weekly inspections, unless their portion(s) of the site has been temporarily stabilized, or runoff is unlikely due to winter conditions or due to



extreme drought as stated in paragraph a) above. The primary permittee (such as a developer) is no longer required to conduct inspections of portions of the site that are covered by a subsequent primary permittee (such as a home builder).

### 3.5.9. Pollution prevention measures for non-stormwater discharges

Sources of non-stormwater listed in section 1.2.3 above of this permit that are combined with stormwater discharges associated with construction activity must be identified in the [SWPPP](#). The plan shall identify and ensure the implementation of appropriate pollution prevention measures for the non-stormwater component(s) of the discharge. Any non-stormwater must be discharged through stable discharge structures. Estimated volume of the non-stormwater component(s) of the discharge must be included in the design of all impacted control measures.

### 3.5.10. Documentation of permit eligibility related to Total Maximum Daily Loads (TMDL)

The [SWPPP](#) must include documentation supporting a determination of permit eligibility with regard to waters that have an approved [TMDL](#) for a pollutant of concern, including:

- a) identification of whether the discharge is identified, either specifically or generally, in an approved [TMDL](#) and any associated wasteload allocations, site-specific requirements, and assumptions identified for the construction stormwater discharge;
- b) summaries of consultation with the division on consistency of [SWPPP](#) conditions with the approved [TMDL](#), and
- c) measures taken to ensure that the discharge of [TMDL](#) identified pollutants from the site is consistent with the assumptions and requirements of the approved [TMDL](#), including any specific wasteload allocation that has been established that would apply to the construction stormwater discharge.

## 4. CONSTRUCTION AND DEVELOPMENT EFFLUENT GUIDELINES

### 4.1. Non-Numeric Effluent Limitations

Any point source authorized by this general permit must achieve, at a minimum, the effluent limitations representing the degree of effluent reduction attainable by application of best practicable control technology (BPT) currently available and is described in sections 4.1.1 through 4.1.7 below.

#### 4.1.1. Erosion Prevention and Sediment Controls

Design, install and maintain effective erosion prevention and sediment controls to minimize the discharge of pollutants. At a minimum, such controls must be designed, installed and maintained to:

- (1) Control stormwater volume and velocity within the site to minimize soil erosion;
- (2) Control stormwater discharges, including both peak flow rates and total stormwater volume, to minimize erosion at outlets and to minimize downstream channel and streambank erosion;
- (3) Minimize the amount of soil exposed during construction activity;
- (4) Minimize the disturbance of [steep slopes](#);

- (5) Eliminate (or minimize if complete elimination is not possible) sediment discharges from the site. The design, installation and maintenance of erosion prevention and sediment controls must address factors such as the design storm (see sub-section 3.5.3.3 above) and soil characteristics, including the range of soil particle sizes expected to be present on the site;
- (6) Provide and maintain natural buffers around surface waters, direct stormwater to vegetated areas to increase sediment removal and maximize stormwater infiltration, unless infeasible (see section 4.1.2 below); and
- (7) Minimize soil compaction and, unless infeasible, preserve topsoil.

#### 4.1.2. Buffer zone requirements

**Buffer zone** requirements in this section apply to all streams adjacent to construction sites, with an exception for streams designated as impaired or Exceptional Tennessee waters (see section 5.4.2 below). A 30-foot natural riparian **buffer zone** adjacent to all streams at the construction site shall be preserved, to the maximum extent practicable, during construction activities at the site. The water quality **buffer zone** is required to protect **waters of the state** (e.g., perennial and intermittent streams, rivers, lakes, wetlands) located within or immediately adjacent to the boundaries of the project, as identified using methodology from Standard Operating Procedures for Hydrologic Determinations (see rules to implement a certification program for Qualified Hydrologic Professionals, [TN Rules Chapter 0400-40-17](#)). **Buffer zones** are not primary sediment control measures and should not be relied on as such. Rehabilitation and enhancement of a natural **buffer zone** is allowed, if necessary, for improvement of its effectiveness of protection of the **waters of the state**. The **buffer zone** requirement only applies to new construction sites, as described in section 2.4.2 above.

The riparian **buffer zone** should be preserved between the top of stream bank and the disturbed construction area. The 30-foot criterion for the width of the **buffer zone** can be established on an average width basis at a project, as long as the minimum width of the **buffer zone** is more than 15 feet at any measured location.

Every attempt should be made for construction activities not to take place within the **buffer zone**. **BMPs** providing equivalent protection to a receiving stream as a natural riparian zone may be used at a construction site. Such equivalent **BMPs** shall be designed to be as effective in protecting the receiving stream from effects of stormwater runoff as a natural riparian zone. A justification for use and a design of equivalent **BMPs** shall be included in the **SWPPP**. Such equivalent **BMPs** are expected to be routinely used at construction projects typically located adjacent to surface waters. These projects include, but are not limited to: sewer line construction, roadway construction, utility line or equipment installation, greenway construction, construction of a permanent outfall or a velocity dissipating structure, etc.

This requirement does not apply to any valid [Aquatic Resources Alteration Permit](#) (ARAP), or equivalent permits issued by federal authorities. Additional **buffer zone** requirements may be established by the local [MS4](#) program.

##### 4.1.2.1. Buffer zone exemption based on existing uses

**Buffer zones** as described in section 4.1.2 above shall not be required to portions of the buffer where certain land uses exist and are to remain in place according to the following:

1. A use shall be considered existing if it was present within the **buffer zone** as of the date of the Notice of Intent for coverage under the CGP. Existing uses shall include, but not be limited to, buildings, parking lots, roadways, utility lines and on-site sanitary sewage systems. Only the portion of the **buffer zone** that contains the footprint of the existing land use is exempt from **buffer zones**. Activities necessary to maintain uses are allowed provided that no additional vegetation is removed from the **buffer zone**.
2. If an area with an existing land use is proposed to be converted to another use or the impervious surfaces located within the buffer area are being removed **buffer zone** requirements shall apply.

#### 4.1.2.2. Pre-Approved Sites

Construction activity at sites that have been pre-approved before February 1, 2010, are exempt from the buffer requirements of section 4.1.2 above. Evidence of pre-approval for highway projects shall be a final right-of-way plan and for other construction projects, the final design drawings with attached dated, written approval by the local, state or federal agency with authority to approve such design drawings for construction.

#### 4.1.3. Soil stabilization

Stabilization of disturbed areas must, at a minimum, be initiated immediately whenever any clearing, grading, excavating or other earth disturbing activities have temporarily or permanently ceased on any portion of the site, and will not resume for a period exceeding 14 calendar days. Soil stabilization (temporary or permanent) of those of disturbed areas must be completed as soon as possible, but not later than 14 days after the construction activity in that portion of the site has temporarily or permanently ceased. In arid, semiarid, and drought-stricken areas where initiating vegetative stabilization measures immediately is infeasible, alternative stabilization measures (such as, but not limited to: properly anchored mulch, soil binders, matting) must be employed.

#### 4.1.4. Dewatering

Discharges from dewatering activities, including discharges from dewatering of trenches and excavations, are prohibited unless managed by appropriate controls. Appropriate controls include, but are not limited to: weir tank, dewatering tank, gravity bag filter, sand media particulate filter, pressurized bag filter, cartridge filter or other control units providing the level of treatment necessary to comply with permit requirements.

#### 4.1.5. Pollution prevention measures

The permittee must design, install, implement, and maintain effective pollution prevention measures to minimize the discharge of pollutants. At a minimum, such measures must be designed, installed, implemented and maintained to:

- (1) Minimize the discharge of pollutants from equipment and vehicle washing, wheel wash water, and other wash waters. Wash waters must be treated in a sediment basin or alternative control that provides equivalent or better treatment prior to discharge;
- (2) Minimize the exposure of building materials, building products, construction wastes, trash, landscape materials, fertilizers, pesticides, herbicides, detergents, sanitary waste and other materials present on the site to precipitation and to stormwater; and
- (3) Minimize the discharge of pollutants from spills and leaks and implement chemical spill and leak prevention and response procedures.

#### 4.1.6. Prohibited discharges

The following discharges are prohibited:

- (1) Wastewater from washout of concrete, unless managed by an appropriate control;
- (2) Wastewater from washout and cleanout of stucco, paint, form release oils, curing compounds and other construction materials;
- (3) Fuels, oils, or other pollutants used in vehicle and equipment operation and maintenance; and
- (4) Soaps or solvents used in vehicle and equipment washing.

#### 4.1.7. Surface outlets

When discharging from basins and impoundments, utilize outlet structures that only withdraw water from near the surface of the basin or impoundment, unless infeasible.

## **5. SPECIAL CONDITIONS, MANAGEMENT PRACTICES, AND OTHER NON-NUMERIC LIMITATIONS**

### **5.1. Releases in Excess of Reportable Quantities**

The discharge of hazardous substances or oil in the stormwater discharge(s) from a facility shall be prevented or minimized in accordance with the applicable stormwater pollution prevention plan for the facility. This permit does not relieve the permittee of the reporting requirements of [40 CFR 117](#) and [40 CFR 302](#). Where a release containing a hazardous substance in an amount equal to or in excess of a reportable quantity established under either [40 CFR 117](#) or [40 CFR 302](#) occurs during a 24 hour period:

- a) the permittee is required to notify the National Response Center (NRC) (800-424-8802) and the Tennessee Emergency Management Agency (emergencies: 800-262-3300; non-emergencies: 800-262-3400) in accordance with the requirements of [40 CFR 117](#) or [40 CFR 302](#) as soon as he or she has knowledge of the discharge;
- b) the permittee shall submit, within 14 days of knowledge of the release, a written description of: the release (including the type and estimate of the amount of material

released), the date that such release occurred, the circumstances leading to the release, what actions were taken to mitigate effects of the release, and steps to be taken to minimize the chance of future occurrences, to the appropriate Environmental Field Office (see subpart 2.8 above); and

- c) the [SWPPP](#) required under part 3 above of this permit must be updated within 14 days of knowledge of the release: to provide a description of the release, the circumstances leading to the release, and the date of the release. This can be accomplished by including a copy of a written description of the release as described in the paragraph b) above. In addition, the [SWPPP](#) must be reviewed to identify measures to prevent the reoccurrence of such releases and to respond to such releases, and the plan must be modified where appropriate.

## 5.2. Spills

This permit does not authorize the discharge of hazardous substances or oil resulting from an on-site spill.

## 5.3. Discharge Compliance with State Water Quality Standards

### 5.3.1. Violation of Water Quality Standards

This permit does not authorize stormwater or other discharges that would result in a violation of a state water quality standard (the TDEC Rules, Chapters [1200-4-3](#), [1200-4-4](#)). Such discharges constitute a violation of this permit.

Where a discharge is already authorized under this permit and the division determines the discharge to cause or contribute to the violation of applicable state water quality standards, the division will notify the [operator](#) of such violation(s). The permittee shall take all necessary actions to ensure future discharges do not cause or contribute to the violation of a water quality standard and shall document these actions in the [SWPPP](#).

### 5.3.2. Discharge quality

- a) The construction activity shall be carried out in such a manner that will prevent violations of water quality criteria as stated in the TDEC Rules, [Chapter 1200-4-3-.03](#). This includes but is not limited to the prevention of any discharge that causes a condition in which visible solids, bottom deposits, or [turbidity](#) impairs the usefulness of [waters of the state](#) for any of the uses designated for that water body by TDEC Rules, [Chapter 1200-4-4](#). Construction activity carried out in the manner required by this permit shall be considered compliance with the TDEC Rules, [Chapter 1200-4-3-.03](#).
- b) There shall be no distinctly visible floating scum, oil or other matter contained in the stormwater discharge.
- c) The stormwater discharge must not cause an objectionable color contrast in the receiving stream.
- d) The stormwater discharge must result in no materials in concentrations sufficient to be hazardous or otherwise detrimental to humans, livestock, wildlife, plant life, or fish and aquatic life in the receiving stream. This provision includes species covered under subpart 1.3 above.

## 5.4. Discharges into Impaired or Exceptional Tennessee Waters

### 5.4.1. Additional SWPPP/BMP Requirements for discharges into impaired or exceptional TN Waters

Discharges that would add loadings of a pollutant that is identified as causing or contributing to an impairment of a water body on the list of [impaired waters](#), or which would cause degradation to waters designated by TDEC as Exceptional Tennessee waters are not authorized by this permit (see subpart 1.3 above). To be eligible to obtain and maintain coverage under this permit, the [operator](#) must satisfy, at a minimum, the following additional requirements for discharges into waters impaired by siltation (or discharges upstream of such waters and because of the proximity to the impaired segment and the nature of the discharge is likely to contribute pollutants of concern in amounts measurable in the impaired segment that may affect the [impaired waters](#)) and for discharges to waters identified by TDEC as Exceptional Tennessee waters (or discharges upstream of such waters and because of the proximity to the exceptional segment and the nature of the discharge is likely to contribute pollutants of concern in amounts measurable in the exceptional segment that may affect the Exceptional Tennessee waters):

- a) The [SWPPP](#) must certify that erosion prevention and sediment controls used at the site are designed to control storm runoff generated by a [5-year, 24-hour storm](#) event (the design storm - see part 10 below: “2-year and 5-year design storm depths and intensities”), as a minimum, either from total rainfall in the designated period or the equivalent intensity as specified on the following website [http://hdsc.nws.noaa.gov/hdsc/pfds/orb/tn\\_pfds.html](http://hdsc.nws.noaa.gov/hdsc/pfds/orb/tn_pfds.html). When clay and other fine particle soils are found on sites, additional physical or chemical treatment of stormwater runoff may be used.
- b) The [SWPPP](#) must be prepared by a person who, at a minimum, has completed the department’s [Level II Design Principles for Erosion Prevention and Sediment Control for Construction Sites](#) course. This requirement goes in effect 24 months following the new permit effective date. A copy of the certification or training record for inspector certification should be included with the [SWPPP](#).
- c) The permittee shall perform inspections described in section 3.5.8 above at least twice every calendar week. Inspections shall be performed at least 72 hours apart.
- d) The permittee must certify on the form provided in Appendix C of this permit whether or not all planned and designed erosion prevention and sediment controls are installed and in working order. The form must contain the printed name and signature of the inspector and the certification must be executed by a person who meets the signatory requirements of section 7.7.2 below of this permit. The record of inspections must be kept at the construction site with a copy of the [SWPPP](#). For record retention requirements, see part 6 below.
- e) In the event the division finds that a discharger is complying with the [SWPPP](#), but contributing to the impairment of receiving stream, then the discharger will be notified by the director in writing that the discharge is no longer eligible for coverage under the general permit. The permittee may update the [SWPPP](#) and implement the necessary changes designed to eliminate further impairment of the receiving stream. If the permittee does not implement the [SWPPP](#) changes within 7 days of receipt of notification, the permittee will be notified in writing that continued discharges must be covered by an individual permit (see subpart 7.12 below). To obtain the individual permit, the [operator](#) must file an individual permit application (EPA Forms 1 and 2F). The project must be stabilized immediately until the [SWPPP](#) is updated and the



individual permit is issued. Only discharges from earth disturbing activities necessary for stabilization are authorized to continue until the individual permit is issued.

- f) For an on-site outfall in a drainage area of a total of 5 or more acres, a minimum temporary (or permanent) sediment basin volume that will provide treatment for a calculated volume of runoff from a [5 year, 24 hour storm](#) and runoff from each acre drained, or equivalent control measures as specified in the [Tennessee Erosion and Sediment Control Handbook](#), shall be provided until final stabilization of the site. A drainage area of 5 or more acres includes both disturbed and undisturbed portions of the site or areas adjacent to the site, all draining through the common outfall. Where an equivalent control measure is substituted for a sediment retention basin, the equivalency must be justified. Runoff from any undisturbed acreage should be diverted around the disturbed area and the sediment basin and, if so, can be omitted from the volume calculation. Sediment storage expected from the disturbed areas must be included and a marker installed signifying a cleanout need.
- g) The director may require revisions to the [SWPPP](#) necessary to prevent a negative impact to legally protected state or federally listed aquatic fauna, their habitat, or the receiving waters.

#### 5.4.2. Buffer zone requirements for discharges into impaired or exceptional TN waters

For sites that contain and/or are adjacent to a receiving stream designated as impaired or Exceptional Tennessee waters a 60-foot natural riparian [buffer zone](#) adjacent to the receiving stream shall be preserved, to the maximum extent practicable, during construction activities at the site. The water quality [buffer zone](#) is required to protect [waters of the state](#) (e.g., perennial and intermittent streams, rivers, lakes, wetlands) located within or immediately adjacent to the boundaries of the project, as identified using methodology from Standard Operating Procedures for Hydrologic Determinations (see rules to implement a certification program for Qualified Hydrologic Professionals , [TN Rules Chapter 0400-40-17](#)). [Buffer zones](#) are not primary sediment control measures and should not be relied on as such. Rehabilitation and enhancement of a natural [buffer zone](#) is allowed, if necessary, for improvement of its effectiveness of protection of the [waters of the state](#). The [buffer zone](#) requirement only applies to new construction sites, as described in section 2.4.2 above.

The natural [buffer zone](#) should be established between the top of stream bank and the disturbed construction area. The 60-foot criterion for the width of the [buffer zone](#) can be established on an average width basis at a project, as long as the minimum width of the [buffer zone](#) is more than 30 feet at any measured location.

Every attempt should be made for construction activities not to take place within the [buffer zone](#). [BMPs](#) providing equivalent protection to a receiving stream as a natural riparian zone may be used at a construction site. Such equivalent [BMPs](#) shall be designed to be as effective in protecting the receiving stream from effects of stormwater runoff as a natural [buffer zone](#). A justification for use and a design of equivalent [BMPs](#) shall be included in the [SWPPP](#). Such equivalent [BMPs](#) are expected to be routinely used at construction projects typically located adjacent to surface waters. These projects include, but are not limited to: sewer line construction, roadway construction, utility line or equipment installation, greenway construction, construction of a permanent outfall or a velocity dissipating structure, etc.

This requirement does not apply to an area that is being altered under the authorization of a valid [Aquatic Resources Alteration Permit](#) (ARAP), or equivalent permits issued by federal

authorities. Additional natural [buffer zone](#) requirements may be established by the local [MS4](#) program.

#### 5.4.2.1. Buffer zone exemption based on existing uses

[Buffer zones](#) as described in section 5.4.2 above shall not be required to portions of the buffer where certain land uses exist and are to remain in place according to the following:

1. A use shall be considered existing if it was present within the [buffer zone](#) as of the date of the Notice of Intent for coverage under the CGP. Existing uses shall include, but not be limited to, buildings, parking lots, roadways, utility lines and on-site sanitary sewage systems. Only the portion of the [buffer zone](#) that contains the footprint of the existing land use is exempt from [buffer zones](#). Activities necessary to maintain uses are allowed provided that no additional vegetation is removed from the [buffer zone](#).
2. If an area with an existing land use is proposed to be converted to another use or the impervious surfaces located within the buffer area are being removed [buffer zone](#) requirements shall apply.

#### 5.4.3. Pre-Approved sites

Construction activity at sites that have been pre-approved before June 16, 2005, are exempt from the design storm requirements of section 5.4.1 a) and e) above and the buffer requirements of section 5.4.2 above. Evidence of pre-approval for highway projects shall be a final right-of-way plan and for other construction projects, the final design drawings with attached dated, written approval by the local, state or federal agency with authority to approve such design drawings for construction.

## **6. RETENTION, ACCESSIBILITY AND SUBMISSION OF RECORDS**

### **6.1. Documents**

The permittee shall retain copies of stormwater pollution prevention plans and all reports required by this permit, and records of all data used to complete the NOI and the NOT to be covered by this permit, for a period of at least three years from the date the notice of termination is submitted. This period may be extended by written request of the director.

### **6.2. Accessibility and Retention of Records**

The permittee shall retain a copy of the [SWPPP](#) required by this permit (including a copy of the permit) at the construction site (or other local location accessible to the director and the public) from the date construction commences to the date of termination of permit coverage. Permittees with day-to-day operational control over pollution prevention plan implementation shall have a copy of the [SWPPP](#) available at a central location onsite for the use of all [operators](#) and those identified as having responsibilities under the plan whenever they are on the construction site. Once coverage is terminated, the permittee shall maintain a copy of all records for a period of three years.

#### 6.2.1. Posting information at the construction site

The permittee shall post a notice near the main entrance of the construction site accessible to the public with the following information:

- a) a copy of the NOC with the NPDES permit tracking number for the construction project;
- b) name, company name, E-mail address (if available), telephone number and address of the project site owner/operator or a local contact person;
- c) a brief description of the project; and
- d) the location of the [SWPPP](#) (see section 3.3.3 above).

The notice must be maintained in a legible condition. If posting this information near a main entrance is infeasible due to safety concerns, or not accessible to the public, the notice shall be posted in a local public building. If the construction project is a [linear construction project](#) (e.g., pipeline, highway, etc.), the notice must be placed in a publicly accessible location near where construction is actively underway and moved as necessary. This permit does not provide the public with any right to trespass on a construction site for any reason, including inspection of a site. This permit does not require that permittees allow members of the public access to a construction site.

The permittee shall also retain following items/information in an appropriate location on-site:

- a) a rain gauge;
- b) a copy of twice weekly inspection reports;
- c) a documentation of quality assurance site assessments, if applicable (see section 3.1.2 above); and
- d) a copy of the site inspector's [Fundamentals of Erosion Prevention and Sediment Control Level 1](#) certification.

### **6.3. Electronic Submission of NOIs, NOTs and Reports**

If the division notifies dischargers (directly by mail or E-mail, by public notice, or by making information available on the world wide web) of electronic forms or other report options that become available at a later date (e.g., electronic submission of forms), the [operators](#) may take advantage of those options to satisfy the NOI, NOT and other report notification requirements.

## **7. STANDARD PERMIT CONDITIONS**

### **7.1. Duty to Comply**

#### 7.1.1. Permittee's duty to comply

The permittee must comply with all conditions of this permit. Any permit noncompliance constitutes a violation of the Tennessee Water Quality Control Act (TWQCA) and is grounds for enforcement action; for permit termination, revocation and reissuance, or modification; or for denial of a permit renewal application.

7.1.2. Penalties for violations of permit conditions

Pursuant to [T.C.A. § 69-3-115](#) of The Tennessee Water Quality Control Act of 1977, as amended:

- a) any person who violates an effluent standard or limitation or a water quality standard established under this part ([T.C.A. § 69-3-101](#), et. seq.); violates the terms or conditions of this permit; fails to complete a filing requirement; fails to allow or perform an entry, inspection, monitoring or reporting requirement; violates a final determination or order of the board, panel or commissioner; or violates any other provision of this part or any rule or regulation promulgated by the board, is subject to a civil penalty of up to ten thousand dollars (\$10,000) per day for each day during which the act or omission continues or occurs;
- b) any person unlawfully polluting the [waters of the state](#) or violating or failing, neglecting, or refusing to comply with any of the provisions of this part ([T.C.A. § 69-3-101](#), et. seq.) commits a Class C misdemeanor. Each day upon which such violation occurs constitutes a separate offense;
- c) any person who willfully and knowingly falsifies any records, information, plans, specifications, or other data required by the board or the commissioner, or who willfully and knowingly pollutes the [waters of the state](#), or willfully fails, neglects or refuses to comply with any of the provisions of this part ([T.C.A. § 69-3-101](#), et. seq.) commits a Class E felony and shall be punished by a fine of not more than twenty-five thousand dollars (\$25,000) or incarceration, or both.

7.1.3. Civil and criminal liability

Nothing in this permit shall be construed to relieve the discharger from civil or criminal penalties for noncompliance. Notwithstanding this permit, the discharger shall remain liable for any damages sustained by the State of Tennessee, including but not limited to fish kills and losses of aquatic life and/or wildlife, as a result of the discharge to any surface or subsurface waters. Additionally, notwithstanding this permit, it shall be the responsibility of the discharger to conduct stormwater discharge activities in a manner such that public or private nuisances or health hazards will not be created. Furthermore, nothing in this permit shall be construed to preclude the State of Tennessee from any legal action or relieve the discharger from any responsibilities, liabilities, or penalties established pursuant to any applicable state law or the Federal Water Pollution Control Act.

7.1.4. Liability under state law

Nothing in this permit shall be construed to preclude the institution of any legal action or relieve the permittee from any responsibilities, liabilities, or penalties established pursuant to any applicable local, state or federal law.

**7.2. Continuation of the Expired General Permit**

Permittees shall maintain coverage under this general permit until a new general permit is issued. Permittees who choose not to maintain coverage under the expired general permit, or are required to obtain an individual permit, must submit an application (U.S. EPA NPDES Forms [1](#) and [2F](#) and any other [applicable forms](#)) at least 180 days prior to expiration of this general permit.

Permittees who are eligible and choose to be covered by the new general permit must submit an NOI by the date specified in that permit. Facilities that have not obtained coverage under this permit by the permit expiration date cannot become authorized to discharge under the continued permit.

Operator(s) of an existing site permitted under the division's 2005 construction general permit shall maintain full compliance with the existing SWPPP. The existing SWPPP should be modified, if necessary, to meet requirements of this new general permit, and the SWPPP changes implemented no later than 12 months following the new permit effective date. The permittee shall make the updated SWPPP available for the division's review upon request.

### **7.3. Need to Halt or Reduce Activity Not a Defense**

It shall not be a defense for a permittee in an enforcement action that it would have been necessary to halt or reduce the permitted activity in order to maintain compliance with the conditions of this permit.

### **7.4. Duty to Mitigate**

The permittee shall take all reasonable steps to minimize or prevent any discharge in violation of this permit that has a reasonable likelihood of adversely affecting human health or the environment.

### **7.5. Duty to Provide Information**

The permittee shall furnish to the division or an authorized representative of the division, within a time specified by the division, any information that the division may request to determine compliance with this permit or other information relevant to the protection of the waters of the state. The permittee shall also furnish to the division, upon request, copies of records required to be kept by this permit.

### **7.6. Other Information**

When the permittee becomes aware that he or she failed to submit any relevant facts or submitted incorrect information in the Notice of Intent or in any other report to the director, he or she shall promptly submit such facts or information.

### **7.7. Signatory Requirements**

All Notices of Intent (NOIs), stormwater pollution prevention plans (SWPPPs), requests for termination of permit coverage (NOTs), Construction Stormwater Inspection Certifications, Construction Stormwater Monitoring Report forms, reports, certifications or information either submitted to the director or the operator of a large or medium municipal separate storm sewer system and/or any other information either submitted to the division, or that this permit requires be maintained by the permittee, shall be signed as described in sections 7.7.1 and 7.7.2 below and dated.

7.7.1. Signatory requirements for a Notice of Intent (NOI)<sup>3</sup>

NOI shall be signed as follows:

- a) For a corporation, by a responsible corporate officer. For the purpose of this section, a responsible corporate officer means:
  - (i) a president, secretary, treasurer, or vice-president of the corporation in charge of a principal business function, or any other person who performs similar policy or decision-making functions for the corporation, or
  - (ii) the manager of one or more manufacturing, production, or operating facilities, provided, the manager is authorized to make management decisions which govern the operation of the regulated site including having the explicit or implicit duty of making major capital investment recommendations, and initiating and directing other comprehensive measures to assure long term environmental compliance with environmental laws and regulations; the manager can ensure that the necessary systems are established or actions taken to gather complete and accurate information for permit application requirements; and where authority to sign documents has been assigned or delegated to the manager in accordance with corporate procedures.

NOTE: The division does not require specific assignments or delegations of authority to responsible corporate officers. The division will presume that these responsible corporate officers have the requisite authority to sign permit applications unless the corporation has notified the director to the contrary. Corporate procedures governing authority to sign permit applications may provide for assignment or delegation to applicable corporate positions rather than to specific individuals.

- b) For a partnership or sole proprietorship, by a general partner or the proprietor, respectively.
- c) For a municipality, state, federal, or other public agency, by either a principal executive officer or ranking elected official. For purposes of this section, a principal executive officer of a Federal agency includes:
  - (i) the chief executive officer of the agency, or
  - (ii) a senior executive officer having responsibility for the overall operations of a principal geographic unit of the agency (e.g., Regional Administrators of EPA).

7.7.2. Signatory requirements for reports and other items

**SWPPPs**, Construction Stormwater Inspection Certification forms, reports, certifications or other information submittals required by the permit and other information requested by the division, including but not limited to Notice of Violation responses, shall be signed by a person described in section 7.7.1 above, or by a duly authorized representative of that person.

---

<sup>3</sup> As specified in 40 CFR 122.22(a)(1)-(3) [48 FR 14153, Apr. 1, 1983, as amended at 48 FR 39619, Sept. 1, 1983; 49 FR 38047, Sept. 29, 1984; 50 FR 6941, Feb. 19, 1985; 55 FR 48063, Nov. 16, 1990; 65 FR 30907, May 15, 2000]



7.7.3. Duly authorized representative

For a purpose of satisfying signatory requirements for reports (see section 7.7.2 above), a person is a duly authorized representative only if:

- a) the authorization is made in writing by a person described in section 7.7.1 above;
- b) the authorization specifies either an individual or a position having responsibility for the overall operation of the regulated site or activity such as the position of plant manager, superintendent, position of equivalent responsibility, or an individual or position having overall responsibility for environmental matters for the company; a duly authorized representative may thus be either a named individual or any individual occupying a named position and,
- c) the written authorization is submitted to the director or an appropriate EFO (see section 2.8 above). The written authorization shall be a written document including the name of the newly authorized person and the contact information (title, mailing address, phone number, fax number and E-mail address) for the authorized person. The written authorization shall be signed by the newly authorized person accepting responsibility and by the person described in section 7.7.1 above delegating the authority.

7.7.4. Changes to authorization

If an authorization under sections 7.7.1 above or 7.7.3 above is no longer accurate because a different individual or position has responsibility as the primary or secondary permittee, but the company name (permittee name) remains the same, a new NOI and **SWPPP** certification shall be submitted to an appropriate EFO (see section 2.8 above) and signed by the new party who meets signatory authority satisfying the requirements of sections 7.7.1 above or 7.7.3 above. The NOI shall include the new individual's information (title, mailing address, phone number, fax number and E-mail address), the existing tracking number and the project name.

7.7.5. Signatory requirements for primary permittees

Primary permittees required to sign an NOI and **SWPPP** because they meet the definition of an **operator** (see subpart 2.2 above) shall sign the following certification statement on the NOI and **SWPPP**:

*"I certify under penalty of law that this document and all attachments were prepared under my direction or supervision in accordance with a system designed to assure that qualified personnel properly gather and evaluate the information submitted. Based on my inquiry of the person or persons who manage the system, or those persons directly responsible for gathering the information, the information submitted is, to the best of my knowledge and belief, true, accurate, and complete. I am aware that there are significant penalties for submitting false information, including the possibility of fine and imprisonment for knowing violations."*

7.7.6. Signatory requirements for secondary permittees

Secondary permittees (typically construction contractors) required to sign an NOI and **SWPPP** because they meet the definition of an **operator** but who are not primarily responsible for

preparing an NOI and [SWPPP](#), shall sign the following certification statement on the NOI and [SWPPP](#):

*“I certify under penalty of law that I have reviewed this document, any attachments, and the SWPPP referenced above. Based on my inquiry of the construction site owner/developer identified above and/or my inquiry of the person directly responsible for assembling this NOI and SWPPP, I believe the information submitted is accurate. I am aware that this NOI, if approved, makes the above-described construction activity subject to NPDES permit number TNR100000, and that certain of my activities on-site are thereby regulated. I am aware that there are significant penalties, including the possibility of fine and imprisonment for knowing violations, and for failure to comply with these permit requirements.”*

### **7.8. Penalties for Falsification of Reports**

Knowingly making any false statement on any report or form required by this permit may result in the imposition of criminal penalties as provided for in [Section 309 of the Clean Water Act](#) and in [T.C.A. §69-3-115](#) of the Tennessee Water Quality Control Act.

### **7.9. Oil and Hazardous Substance Liability**

Nothing in this permit shall be construed to preclude the institution of any legal action or relieve the permittee from any responsibilities, liabilities, or penalties to which the permittee is or may be subject to [Section 311 of the Clean Water Act](#) or [Section 106 of the Comprehensive Environmental Response, Compensation and Liability Act](#) of 1980 (CERCLA).

### **7.10. Property Rights**

The issuance of this permit does not convey any property rights of any sort, nor any exclusive privileges, nor does it authorize any injury to private property nor any invasion of personal rights, nor any infringement of federal, state or local laws or regulations. The issuance of this permit does not authorize trespassing or discharges of stormwater or non-stormwater across private property.

### **7.11. Severability**

The provisions of this permit are severable, and if any provision of this permit, or the application of any provision of this permit to any circumstance, is held invalid, the application of such provision to other circumstances, and the remainder of this permit shall not be affected thereby.

### **7.12. Requiring an Individual Permit**

#### **7.12.1. Director can require a site to obtain an individual permit**

The director may require any person authorized by this permit to apply for and/or obtain an individual NPDES permit in order to obtain adequate protection of designated uses of a receiving stream. Any interested person may petition the director in writing to take action under this paragraph, but must include in their petition the justification for such an action. Where the

director requires a discharger authorized to discharge under this permit to apply for an individual NPDES permit, the director shall notify the discharger in writing that an individual permit application is required. This notification will include a brief statement of the reasons for this decision, an application form, a statement setting a deadline for the discharger to file the application, and a statement that coverage under this general permit shall terminate upon the effective date of an individual NPDES permit or denial of coverage under an individual permit. The notification may require stabilization of the site and suspend coverage under this general permit until the individual permit is issued. Individual permit applications shall be submitted to the appropriate Environmental Field Office of the division as indicated in subpart 2.8 above of this permit. The director may grant additional time to submit the application upon request of the applicant. If a discharger fails to submit in a timely manner an individual NPDES permit application as required by the director under this paragraph, then the applicability of this permit to the discharger will be terminated at the end of the day specified by the director for application submittal.

If the decision to require an individual NPDES permit precedes the issuance of coverage under this general permit, earth disturbing activities cannot begin until the individual permit is issued.

7.12.2. Permittee may request individual permit instead of coverage under this general permit

Any discharger authorized by this permit may request to be excluded from the coverage of this permit by applying for an individual permit. Any discharger that knowingly cannot abide by the terms and conditions of this permit must apply for an individual permit. In such cases, the permittee shall submit an individual application in accordance with the requirements of [40 CFR 122.26\(c\)\(1\)\(ii\)](#), with reasons supporting the request, to the appropriate division's Environmental Field Office. The request may be granted by issuance of an individual permit, or alternative general permit, if the reasons cited by the permittee are adequate to support the request.

7.12.3. Individual permit terminates general permit

When an individual NPDES permit is issued to a discharger otherwise subject to this permit, or the discharger is authorized to discharge under an alternative NPDES general permit, the applicability of this permit to the discharger is terminated on the effective date of the individual permit or the date of authorization of coverage under the alternative general permit, whichever the case may be. When an individual NPDES permit is denied to an owner or [operator](#) otherwise subject to this permit, or the owner or [operator](#) is denied for coverage under an alternative NPDES general permit, the applicability of this permit to the individual NPDES permittee is terminated on the date of such denial, unless otherwise specified by the director. Coverage under the [Tennessee Multi-Sector General Permit for the Discharge of Stormwater from an Industrial Activity](#) (TMSP) will not be considered as an alternative general permit under this section without being specified by the director.

**7.13. Other, Non-Stormwater, Program Requirements**

No condition of this permit shall release the permittee from any responsibility or requirements under other environmental statutes or regulations.

#### **7.14. Proper Operation and Maintenance**

The permittee shall at all times properly operate and maintain all facilities and systems of treatment and control (and related equipment) which are installed or used by the permittee to achieve compliance with the conditions of this permit and with the requirements of stormwater pollution prevention plans.

Proper operation and maintenance also includes adequate laboratory quality assurance and quality control procedures. Proper operation and maintenance requires the operation of backup or auxiliary facilities or similar systems, installed by a permittee, when determined by the permittee or the division to be necessary to achieve compliance with the conditions of the permit.

#### **7.15. Inspection and Entry**

The permittee shall allow authorized representatives of the Environmental Protection Agency, the director or an authorized representative of the commissioner of TDEC, or, in the case of a construction site which discharges through a municipal separate storm sewer, an authorized representative of the [MS4](#) receiving the discharge, upon the presentation of credentials and other documents as may be required by law:

- a) to enter upon the permittee's premises where a regulated facility or activity is located or conducted or where records must be kept under the conditions of this permit;
- b) to have access to and copy at reasonable times, any records that must be kept under the conditions of this permit; and
- c) to inspect any facilities or equipment (including monitoring and control equipment).

#### **7.16. Permit Actions**

This permit may be issued, modified, revoked, reissued or terminated for cause in accordance with this permit and the applicable requirements of [T.C.A. § 69-3-108](#). The filing of a request by the permittee for a permit modification, revocation and reissuance, or termination, or a notification of planned changes or anticipated noncompliance does not stay any permit condition.

8.1.1. Termination of builder and contractor coverage

### **8. REQUIREMENTS FOR TERMINATION OF COVERAGE**

#### **8.1. Termination of Developer and Builder Coverage**

##### 8.1.1. Termination process for primary permittees

Primary permittees wishing to terminate coverage under this permit must submit a completed notice of termination (NOT) form, provided in Appendix B of this permit (or copy thereof). Primary permittees who abandon the site and fail to submit the NOT will be in violation of this permit. Signs notifying the public of the construction activity shall be in place until the NOT form has been submitted. Primary permittees may terminate permit coverage only if the conditions described in items 1, 2 or 3 below occur at the site:

1. All earth-disturbing activities at the site are completed and, if applicable, construction support activities permitted under section 1.2.2 above, and the following requirements are met:
  - (a) For any areas that
    - were disturbed during construction,
    - are not covered over by permanent structures, and
    - over which the permittee had control during the construction activitiesthe requirements for final vegetative or non-vegetative stabilization described in subsection 3.5.3.2 above are met;
  - (b) The permittee has removed and properly disposed of all construction materials, waste and waste handling devices, and have removed all equipment and vehicles that were used during construction, unless intended for long-term use following termination of permit coverage;
  - (c) The permittee has removed all stormwater controls that were installed and maintained during construction, except those that are intended for long-term use following termination of permit coverage;
  - (d) The permittee has removed all potential pollutants and pollutant-generating activities associated with construction, unless needed for long-term use following termination of permit coverage; and
  - (e) The permittee must identify who is responsible for ongoing maintenance of any stormwater controls left on the site for long-term use following termination of permit coverage; or
2. The permittee has transferred control of all areas of the site for which he is responsible (including, but not limited to, infrastructure, common areas, stormwater drainage structures, sediment control basin, etc.) under this permit to another operator, and that operator has submitted an NOI and obtained coverage under this permit; or
3. The permittee obtains coverage under an individual or alternative general NPDES permit.

8.1.2. NOT review

The division will review NOTs for completeness and accuracy and, when necessary, investigate the proposed site for which the NOT was submitted. Upon completing the NOT review, the division will:

- 1) prepare and transmit a notification that a NOT form was received;
- 2) notify the applicant of needed changes to their NOT submittal; or
- 3) deny a request for termination of coverage under this general permit.

The division retains the right to deny termination of coverage under this general permit upon receipt of the NOT. If the local Environmental Field Office has information indicating that the permit coverage is not eligible for termination, written notification will be provided that permit

coverage has not been terminated. The notification will include a summary of existing deficiencies. When the site meets the termination criteria, the NOT should be re-submitted.

If any permittee files for bankruptcy or the site is foreclosed on by the lender, the permittee should notify the division of the situation so that the division may assess the site to determine if permit coverage should be obtained by any other person or whether other action is needed.

## **8.2. Termination of Builder and Contractor Coverage**

### **8.2.1. Termination process for secondary permittees**

Secondary permittees (builders/contractors) must request termination of coverage under this permit by submitting an NOT when they are no longer an operator at the construction site. Secondary permittees receive coverage under this permit, but are not normally mailed a Notice of Coverage. Consequently, the division may, but is not required to, notify secondary permittees that their notice of termination has been received. If the division has reason to believe that the secondary permittee's NOT should not have been submitted, the division will deny the secondary permittee's NOT in writing, with specific reasons as to why the NOT should not have been submitted.

## **8.3. NOT certification**

The NOT and the following certification must be signed in accordance with subpart 7.7 above (Signatory Requirements) of this permit:

*"I certify under penalty of law that either: (a) all stormwater discharges associated with construction activity from the portion of the identified facility where I was an operator have ceased or have been eliminated or (b) I am no longer an operator at the construction site. I understand that by submitting this notice of termination, I am no longer authorized to discharge stormwater associated with construction activity under this general permit, and that discharging pollutants in stormwater associated with construction activity to waters of the United States is unlawful under the Clean Water Act where the discharge is not authorized by a NPDES permit. I also understand that the submittal of this notice of termination does not release an operator from liability for any violations of this permit or the Clean Water Act."*

## **8.4. Where to Submit a Notice of Termination (NOT)?**

The NOT shall be submitted to the Environmental Field Office (EFO) which issued the NOC to the primary permittee. A list of counties and the corresponding EFOs is provided in subpart 2.8 above. The appropriate permit tracking number must be clearly printed on the form.

## **9. Aquatic Resource Alteration Permits (ARAP)**

Alterations to channels or waterbodies (stream, wetland and/or other [waters of the state](#)) that are contained on, traverse through or are adjacent to the construction site, may require an [Aquatic Resources Alteration Permit](#) (ARAP) (<http://www.tn.gov/environment/permits/arap.shtml>). It is



the responsibility of the developer to provide a determination of the water's status<sup>4</sup>. This determination must be conducted using methodology from Standard Operating Procedures for Hydrologic Determinations (see rules to implement a certification program for Qualified Hydrologic Professionals, [TN Rules Chapter 0400-40-17](#)). The permittee can make an assumption that streams/wetlands are present at the site in order to expedite the permit process. In some cases, issuance of coverage under the CGP may be delayed or withheld if the appropriate ARAP has not been obtained. At a minimum, any delay in obtaining an ARAP for water body alteration associated with the proposed project must be adequately addressed in the [SWPPP](#) prior to issuance of an NOC. Failure to obtain an ARAP prior to any actual alteration may result in enforcement action for the unauthorized alteration.

## 10. DEFINITIONS

**“2-year and 5-year design storm depths and intensities”** The estimated design rainfall amounts, for any return period interval (i.e., 2-yr, 5-yr, 25-yr, etc.) in terms of either 24-hour depths or intensities for any duration, can be found by accessing the following NOAA National Weather Service Atlas 14 data for Tennessee:  
[http://hdsc.nws.noaa.gov/hdsc/pfds/orb/tn\\_pfds.html](http://hdsc.nws.noaa.gov/hdsc/pfds/orb/tn_pfds.html). Other data sources may be acceptable with prior written approval by TDEC Water Pollution Control.

**“Best Management Practices”** (“BMPs”) means schedules of activities, prohibitions of practices, maintenance procedures, and other management practices to prevent or reduce the discharge of pollutants to [waters of the state](#). BMPs also include treatment requirements, operating procedures, and practices to control plant site runoff, spillage or leaks, sludge or waste disposal, or drainage from raw material storage.

**“Borrow Pit”** is an excavation from which erodible material (typically soil) is removed to be fill for another site. There is no processing or separation of erodible material conducted at the site. Given the nature of activity and pollutants present at such excavation, a borrow pit is considered a construction activity for the purpose of this permit.

**“Buffer Zone”** is a strip of dense undisturbed perennial native vegetation, either original or re-established, that borders streams and rivers, ponds and lakes, wetlands, and seeps. Buffer zones are established for the purposes of slowing water runoff, enhancing water infiltration, and minimizing the risk of any potential nutrients or pollutants from leaving the upland area and reaching surface waters. Buffer zones are most effective when stormwater runoff is flowing into and through the buffer zone as shallow sheet flow, rather than in concentrated form such as in channels, gullies, or [wet weather conveyances](#). Therefore, it is critical that the design of any development include management practices, to the maximum extent practical, that will result in stormwater runoff flowing into and through the buffer zone as shallow sheet flow. Buffer zones are established for the primary purpose of protecting water quality and maintaining a healthy aquatic ecosystem in receiving waters.

**“Clearing”** in the definition of discharges associated with construction activity, typically refers to removal of vegetation and disturbance of soil prior to grading or excavation in anticipation of construction activities. Clearing may also refer to wide area land disturbance in anticipation of

---

<sup>4</sup> The EPA considers inventorying a site's natural features is a technique called fingerprinting. More info can be found in EPA's document - EPA's Developing Your SWPPP – A Guide for Construction Sites (EPA-833-R-06-004 May 2007)

non-construction activities; for instance, clearing forested land in order to convert forestland to pasture for wildlife management purposes. Clearing, grading and excavation do not refer to clearing of vegetation along existing or new roadways, highways, dams or power lines for sight distance or other maintenance and/or safety concerns, or cold planing, milling, and/or removal of concrete and/or bituminous asphalt roadway pavement surfaces. The clearing of land for agricultural purposes is exempt from federal stormwater NPDES permitting in accordance with Section 401(1)(1) of the 1987 Water Quality Act and state stormwater NPDES permitting in accordance with the Tennessee Water Quality Control Act of 1977 ([T.C.A. 69-3-101](#) et seq.).

**“Commencement of construction”** The initial disturbance of soils associated with clearing, grading, or excavating activities or other construction activities.

**“Common plan of development or sale”** is broadly defined as any announcement or documentation (including a sign, public notice or hearing, sales pitch, advertisement, drawing, permit application, zoning request, computer design, etc.) or physical demarcation (including boundary signs, lot stakes, surveyor markings, etc.) indicating construction activities may occur on a specific plot. A common plan of development or sale identifies a situation in which multiple areas of disturbance are occurring on contiguous areas. This applies because the activities may take place at different times, on different schedules, by different operators.

**“Control measure”** As used in this permit, refers to any Best Management Practice (BMP) or other method used to prevent or reduce the discharge of pollutants to [waters of the state](#).

**“CWA”** means the Clean Water Act of 1977 or the Federal Water Pollution Control Act ([33 U.S.C. 1251](#), et seq.)

**“Department”** means the Department of Environment and Conservation.

**“Director”** means the director, or authorized representative, of the Division of Water Pollution Control of the State of Tennessee, Department of Environment and Conservation.

**“Discharge of stormwater associated with construction activity”** As used in this permit, refers to stormwater point source discharges from areas where soil disturbing activities (e.g., clearing, grading, excavation, etc.), or construction materials or equipment storage or maintenance (e.g., earth fill piles, fueling, waste material etc.) are located.

**“Division”** means the Division of Water Pollution Control of the State of Tennessee, Department of Environment and Conservation.

**“Final Stabilization”** means that all soil disturbing activities at the site have been completed and one of the three following criteria is met:

- a. A uniform (e.g., evenly distributed, without large bare areas) perennial vegetative cover with a uniform density of at least 70 percent of the (preferably) native vegetative cover for the area has been established on all unpaved areas and areas not covered by permanent structures, and all slopes and channels have been permanently stabilized against erosion, or

- b. Equivalent permanent stabilization measures (such as the use of riprap; permanent geotextiles, hardened surface materials including concrete, asphalt, gabion baskets, or Reno mattresses) have been employed, or
- c. For construction projects on land used for agricultural or silvicultural purposes, final stabilization may be accomplished by returning the disturbed land to its preconstruction agricultural or silvicultural use.

**“Exceptional Tennessee waters”** are surface waters of the State of Tennessee that satisfy characteristics of exceptional Tennessee waters as listed [Chapter 1200-4-3-.06](#) of the official compilation - Rules and Regulations of the State of Tennessee. Characteristics include waters designated by the Water Quality Control Board as Outstanding National Resource Waters (ONRW); waters that provide habitat for ecologically significant populations of certain aquatic or semi-aquatic plants or animals; waters that provide specialized recreational opportunities; waters that possess outstanding scenic or geologic values; or waters where existing conditions are better than water quality standards.

**“Impaired waters”** (unavailable conditions waters) means any segment of surface waters that has been identified by the division as failing to support one or more classified uses. For the purpose of this permit, pollutants of concern include, but are not limited to: siltation (silt/sediment) and habitat alterations. Based on the most recent assessment information available to staff, the division will notify applicants and permittees if their discharge is into, or is affecting, impaired waters. Resources to be used in making this determination include biennial compilations of impaired waters, databases of assessment information, updated [GIS](#) coverages (<http://tnmap.tn.gov/wpc/>), and the results of recent field surveys. [GIS](#) coverages of the streams and lakes not meeting water quality standards, plus the biennial list of impaired waters, can be found at <http://tn.gov/environment/wpc>.

**“Improved sinkhole”** is a natural surface depression that has been altered in order to direct fluids into the hole opening. Improved sinkhole is a type of injection well regulated under the [Underground Injection Control](#) (UIC) program. Underground injection constitutes an intentional disposal of waste waters in natural depressions, open fractures, and crevices (such as those commonly associated with weathering of limestone).

**“Inspector”** An inspector is a person that has successfully completed (has a valid certification from) the [“Fundamentals of Erosion Prevention and Sediment Control Level I”](#) course or equivalent course. An inspector performs and documents the required inspections, paying particular attention to time-sensitive permit requirements such as stabilization and maintenance activities. An inspector may also have the following responsibilities:

- a) oversee the requirements of other construction-related permits, such as [Aquatic Resources Alteration Permit](#) (ARAP) or Corps of Engineers permit for construction activities in or around [waters of the state](#);
- b) update field [SWPPPs](#);
- c) conduct pre-construction inspection to verify that undisturbed areas have been properly marked and initial measures have been installed; and
- d) inform the permit holder of activities that may be necessary to gain or remain in compliance with the CGP and other environmental permits.

**“Linear Project”** – is a land disturbing activity as conducted by an underground/overhead utility or highway department, including but not limited to any cable line or wire for the transmission of electrical energy; any conveyance pipeline for transportation of gaseous or liquid substance; any cable line or wire for communications; or any other energy resource transmission ROW or utility infrastructure, e.g., roads and highways. Activities include the construction and installation of these utilities within a corridor. Linear project activities also include the construction of access roads, staging areas, and borrow/spoil sites associated with the linear project. Land disturbance specific to the development of a residential and/or commercial subdivision or high-rise structures is not considered a linear project.

**“Monthly”** refers to calendar months.

**“Municipal Separate Storm Sewer System”** or **“MS4”** is defined at [40 CFR §122.26\(b\)\(8\)](#) to mean a conveyance or system of conveyances (including roads with drainage systems, municipal streets, catch basins, curbs, gutters, ditches, manmade channels, or storm drains):

1. Owned and operated by a state, city, town, borough, county, parish, district, association, or other public body (created by or pursuant to state law) having jurisdiction over disposal of sewage, industrial wastes, stormwater, or other wastes, including special districts under state law such as a sewer district, flood control district or drainage district, or similar entity, or an Indian tribe or an authorized Indian tribal organization, or a designated and approved management agency under section [208 of the CWA](#) that discharges to waters of the United States;
2. Designed or used for collecting or conveying stormwater;
3. Which is not a combined sewer; and
4. Which is not part of a Publicly Owned Treatment Works (POTW) as defined at [40 CFR §122.2](#).

**“NOI”** means notice of intent to be covered by this permit (see part 2 above of this permit.)

**“NOT”** means notice of termination (see part 8 above of this permit).

**“Operator”** for the purpose of this permit and in the context of stormwater associated with construction activity, means any person associated with a construction project that meets either of the following two criteria:

- a) This person has operational or design control over construction plans and specifications, including the ability to make modifications to those plans and specifications. This person is typically the owner or developer of the project or a portion of the project, and is considered the primary permittee; or
- b) This person has day-to-day operational control of those activities at a project which are necessary to ensure compliance with a [SWPPP](#) for the site or other permit conditions. This person is typically a contractor or a commercial builder who is hired by the primary permittee, and is considered a secondary permittee.

It is anticipated that at different phases of a construction project, different types of parties may satisfy the definition of “operator.”

**“Point source”** means any discernible, confined, and discrete conveyance, including but not limited to, any pipe, ditch, channel, tunnel, conduit, well, discrete fissure, container, rolling stock, concentrated animal feeding operation, landfill leachate collection system, vessel or other floating craft from which pollutants are or may be discharged. This term does not include introduction of pollutants from non point-source agricultural and silvicultural activities, including stormwater runoff from orchards, cultivated crops, pastures, range lands, and forest lands or return flows from irrigated agriculture or agricultural stormwater runoff.

**“Qualifying State, Tribal, or local erosion and sediment control program”** is one that includes, as defined in [40 CFR 122.44\(s\)](#):

- (i) Requirements for construction site operators to implement appropriate erosion and sediment control best management practices;
- (ii) Requirements for construction site operators to control waste such as discarded building materials, concrete truck washout, chemicals, litter, and sanitary waste at the construction site that may cause adverse impacts to water quality;
- (iii) Requirements for construction site operators to develop and implement a stormwater pollution prevention plan. (A stormwater pollution prevention plan includes site descriptions, descriptions of appropriate control measures, copies of approved State, Tribal or local requirements, maintenance procedures, inspection procedures, and identification of non-stormwater discharges); and
- (iv) Requirements to submit a site plan for review that incorporates consideration of potential water quality impacts.

**“Quality Assurance Site Assessment”** means documented site inspection to verify the functionality and performance of the [SWPPP](#) and for determining if construction, operation and maintenance accurately comply with permit requirements, as presented in the narrative, engineering specifications; maps, plans and drawings; and details for erosion prevention, sediment control and stormwater management.

**“Registered Engineer”** and **“Registered Landscape Architect”** An engineer or landscape architect certified and registered by the [State Board of Architectural and Engineer Examiners](#) pursuant to [Section 62-202, Tennessee Code Annotated](#), to practice in Tennessee.

**“Runoff coefficient”** means the fraction of total rainfall that will appear at the conveyance as runoff. Runoff coefficient is also defined as the ratio of the amount of water that is NOT absorbed by the surface to the total amount of water that falls during a rainstorm.

**“Sediment”** means solid material, both inorganic (mineral) and organic, that is in suspension, is being transported, or has been moved from the site of origin by wind, water, gravity, or ice as a product of erosion.

**“Sediment basin”** A temporary basin consisting of an embankment constructed across a wet weather conveyance, or an excavation that creates a basin or by a combination of both. A sediment basin typically consists of a forebay cell, dam, impoundment, permanent pool, primary spillway, secondary or emergency spillway, and surface dewatering device. The size and shape of the basin depends on the location, size of drainage area, incoming runoff volume and peak flow, soil type and particle size, land cover, and receiving stream classification (i.e., impaired, HQ, or unimpaired).

“**Sedimentation**” means the action or process of forming or depositing sediment.

“**Significant contributor of pollutants to waters of the state**” means any discharge containing pollutants that are reasonably expected to cause or contribute to an impairment of receiving stream water quality or designated uses.

“**Soil**” means the unconsolidated mineral and organic material on the immediate surface of the earth that serves as a natural medium for the growth of plants.

“**Steep Slope**” A natural or created slope of 35% grade or greater. Designers of sites with steep slopes must pay attention to stormwater management in the **SWPPP** to engineer runoff non-erosively around or over a steep slope. In addition, site managers should focus on erosion prevention on the slope(s) and stabilize the slope(s) as soon as practicable to prevent slope failure and/or sediment discharges from the project.

“**Stormwater**” means rainfall runoff, snow melt runoff, and surface runoff and drainage.

“**Stormwater associated with industrial activity**” is defined at [40 CFR 122.26\(b\)\(14\)](#) and incorporated here by reference. Most relevant to this permit is [40 CFR 122.26\(b\)\(14\)\(x\)](#), which relates to construction activity including clearing, grading, filling and excavation activities (including borrow pits containing erodible material). Disturbance of soil for the purpose of crop production is exempted from permit requirements, but stormwater discharges from agriculture-related activities which involve construction of structures (e.g., barn construction, road construction, pond construction, etc.) are considered associated with industrial activity. Maintenance performed to maintain the original line and grade, hydraulic capacity, or original purpose of the facility, e.g. re-clearing, minor excavation performed around an existing structure necessary for maintenance or repair, and repaving of an existing road, is not considered a construction activity for the purpose of this permit.

“**Stormwater discharge-related activities**” include: activities which cause, contribute to, or result in point source stormwater pollutant discharges, including but not limited to: excavation, site development, grading and other surface disturbance activities; and measures to control stormwater including the siting, construction and operation of best management practices (BMPs) to control, reduce or prevent stormwater pollution.

“**Stormwater Pollution Prevention Plan**”(SWPPP): A written plan required by this permit that includes site map(s), an identification of construction/contractor activities that could cause pollutants in the stormwater, and a description of measures or practices to control these pollutants. It must be prepared and approved before construction begins. In order to effectively reduce erosion and sedimentation impacts, Best Management Practices (BMPs) must be designed, installed, and maintained during land disturbing activities. The SWPPP should be prepared in accordance with the [Tennessee Erosion and Sediment Control Handbook](#). The handbook is designed to provide information to planners, developers, engineers, and contractors on the proper selection, installation, and maintenance of BMPs. The handbook is intended for use during the design and construction of projects that require erosion and sediment controls to protect **waters of the state**. It also aids in the development of SWPPPs and other reports, plans, or specifications required when participating in Tennessee's water quality regulations.



“**Take**” of an endangered species means to harass, harm, pursue, hunt, shoot, wound, kill, trap, capture or collect, or attempt to engage in any such conduct.

“**Temporary stabilization**” is achieved when vegetation and/or a non-erodible surface have been established on the area of disturbance and construction activity has temporarily ceased. Under certain conditions, temporary stabilization is required when construction activities temporarily cease. However, if future construction activity is planned, permit coverage continues.

“**Total maximum daily load**” (TMDL) The sum of the individual wasteload allocations for point sources and load allocations for nonpoint sources and natural background ([40 CFR 130.2\(I\)](#)). TMDL is a study that: quantifies the amount of a pollutant in a stream, identifies the sources of the pollutant, and recommends regulatory or other actions that may need to be taken in order for the stream to cease being polluted. Some of the actions that might be taken are:

- 1.) Re-allocation of limits on the sources of pollutants documented as impacting streams. It might be necessary to lower the amount of pollutants being discharged under NPDES permits or to require the installation of other control measures, if necessary, to ensure that water quality standards will be met.
- 2.) For sources over which the division does not have regulatory authority, such as ordinary agricultural or forestry activities, provide information and technical assistance to other state and federal agencies that work directly with these groups to install appropriate Best Management Practices (BMPs).

Even for impacted streams, TMDL development is not considered appropriate for all bodies of water: if enforcement has already been taken and a compliance schedule has been developed; or if best management practices have already been installed for non-regulated activities, the TMDL is considered not applicable. In cases involving pollution sources in other states, the recommendation may be that another state or EPA perform the TMDL . TMDLs can also be described by the following equation:

$$\text{TMDL} = \text{sum of non point sources (LA)} + \text{sum of point sources (WLA)} + \text{margin of safety}$$

A list of completed TMDLs that have been approved by EPA can be found at our web site: <http://tn.gov/environment/wpc/tmdl/approved.shtml>

“**Turbidity**” is the cloudiness or haziness of a fluid caused by individual particles (suspended solids) that are generally invisible to the naked eye, similar to smoke in air.

“**Waters**” or “**waters of the state**” means any and all water, public or private, on or beneath the surface of the ground, which are contained within, flow through, or border upon Tennessee or any portion thereof except those bodies of water confined to and retained within the limits of private property in single ownership which do not combine or effect a junction with natural surface or underground waters.

“**Waste site**” is an area where material from a construction site is disposed of. When the material is erodible, such as soil, the site must be treated as a construction site.

“**Wet weather conveyances**” are man-made or natural watercourses, including natural watercourses that have been modified by channelization that flow only in direct response to

precipitation runoff in their immediate locality; whose channels are at all times above the ground water table; that are not suitable for drinking water supplies; and in which hydrological and biological analyses indicate that, under normal weather conditions, due to naturally occurring ephemeral or low flow there is not sufficient water to support fish or multiple populations of obligate lotic aquatic organisms whose life cycle includes an aquatic phase of at least two months. (Rules and Regulations of the State of Tennessee, Chapter [1200-4-3-.04\(3\)](#)).

## 11. LIST OF ACRONYMS

ARAP	Aquatic Resource Alteration Permit
BMP	Best Management Practice
CERCLA	Comprehensive Environmental Response, Compensation and Liability Act
CGP	Construction General Permit
CWA	Clean Water Act
EFO	Environmental Field Office
EPA	(U.S.) Environmental Protection Agency
EPSC	Erosion Prevention and Sediment Control
MS4	Municipal Separate Storm Sewer System
NOC	Notice of Coverage
NOI	Notice of Intent
NOT	Notice of Termination
NPDES	National Pollutant Discharge Elimination System
ONRW	Outstanding National Resource Waters
POTW	Publicly Owned Treatment Works
SWPPP	Stormwater Pollution Prevention Plan
TDEC	Tennessee Department of Environment and Conservation
TDOT	Tennessee Department of Transportation
TMDL	Total Maximum Daily Load
TMSP	Tennessee Multi-Sector General Permit for the Discharge of Stormwater from an Industrial Activity
TVA	Tennessee Valley Authority
TWQCA	Tennessee Water Quality Control Act
UIC	Underground Injection Control
USGS	United States Geological Survey

(End of body of permit; appendices follow.)

**APPENDIX A – Notice of Intent (NOI) Form**  
(next page)



TENNESSEE DEPARTMENT OF ENVIRONMENT AND CONSERVATION (TDEC)

Division of Water Resources

6<sup>th</sup> Floor Annex, L&C Tower, 401 Church Street, Nashville, Tennessee 37243

1-888-891-8332 (TDEC)

Notice of Intent (NOI) for General NPDES Permit for Stormwater Discharges from Construction Activities (TNR100000)

Form section containing: Site or Project Name, Existing NPDES Tracking Number: TNR, Street Address or Location, Start date, Estimated end date, Site Activity Description, Latitude (dd.dddd), Longitude (dd.dddd), County(ies), MS4 Jurisdiction, Acres Disturbed, Total Acres, Does a topographic map show dotted or solid blue lines and/or wetlands on or adjacent to the construction site?, Receiving waters, Attach the SWPPP with the NOI, Attach a site location map.

Form section containing: Site Owner/Developer Entity (Primary Permittee), Site Owner/Developer Signatory (V.P. level/higher - signs certification below), Signatory's Title or Position (V.P. level/higher - signs certification below), Mailing Address, City, State, Zip, Phone, Fax, E-mail, Optional Contact, Title or Position.

Owner or Developer Certification (must be signed by president, vice-president or equivalent, or ranking elected official) (Primary Permittee). I certify under penalty of law that this document and all attachments were prepared by me, or under my direction or supervision. Owner or Developer Name; (print or type), Signature, Date.

Contractor(s) Certification (must be signed by president, vice-president or equivalent, or ranking elected official) (Secondary Permittee). I certify under penalty of law that I have reviewed this document, any attachments, and the SWPPP referenced above. Contractor company name (print or type).

Contractor signatory (print/type): (V.P. level or higher), Signature, Date, Mailing Address, City, State, Zip, Phone, Fax, E-mail.

Other Contractor company name (print or type), Other Contractor signatory (print/type): (V.P. level or higher), Signature, Date, Mailing Address, City, State, Zip, Phone, Fax, E-mail.

OFFICIAL STATE USE ONLY

Received Date, Reviewer, Field Office, Permit Number TNR, Exceptional TN Water, Fee(s), T & E Aquatic Flora and Fauna, Impaired Receiving Stream, Notice of Coverage Date.

**Notice of Intent (NOI) for General NPDES Permit for Stormwater Discharges from Construction Activities (TNR100000)**

**Purpose of this form** A completed notice of intent (NOI) must be submitted to obtain coverage under the Tennessee General NPDES Permit for Discharges of Stormwater Associated with Construction Activity (permit). **Requesting coverage under this permit means that an applicant has obtained and examined a copy of this permit, and thereby acknowledges applicant’s claim of ability to be in compliance with permit terms and conditions.** This permit is required for stormwater discharge(s) from construction activities including clearing, grading, filling and excavating (including borrow pits) of one or more acres of land. This form should be submitted at least 30 days prior to the commencement of land disturbing activities, or no later than 48 hours prior to when a new operator assumes operational control over site specifications or commences work at the site.

**Permit fee** (see table below) must accompany the NOI and is based on total acreage to be disturbed by an entire project, including any associated construction support activities (e.g. equipment staging yards, material storage areas, excavated material disposal areas, borrow or waste sites). There is no fee for sites less than 1 acre.

<b>Acres Disturbed</b>	= or > 150 acres	= or > 50 < 150 acres	= or > 5 < 50 acres	= or > 1 < 5 acres
<b>Fee</b>	\$7,500	\$4,000	\$1,000	\$250

**Who must submit the NOI form?** Per Section 2 of the permit, all site operators must submit an NOI form. “Operator” for the purpose of this permit and in the context of stormwater associated with construction activity means any person associated with a construction project who meets either or both of the following two criteria: (1) The person has operational or design control over construction plans and specifications, including the ability to make modifications to those plans and specifications. This person is typically the owner or developer of the project or a portion of the project (e.g. subsequent builder), or the person that is the current land owner of the construction site. This person is considered the primary permittee; or (2) The person has day-to-day operational control of those activities at a project which are necessary to ensure compliance with a SWPPP for the site or other permit conditions. This person is typically a contractor or a commercial builder who is hired by the primary permittee, and is considered a secondary permittee.

Owners, developers and all contractors that meet the definition of the operator in subsection 2.2 of the permit shall apply for permit coverage on the same NOI, insofar as possible. After permit coverage has been granted to the primary permittee, any subsequent NOI submittals must include the site’s previously assigned permit tracking number and the project name. The comprehensive site-specific SWPPP shall be prepared in accordance with the requirements of part 3 of the permit and must be submitted with the NOI unless the NOI being submitted is to only add a contractor (secondary permittee) to an existing coverage.

**Notice of Coverage** The division will review the NOI for completeness and accuracy and prepare a notice of coverage (NOC). Stormwater discharge from the construction site is authorized as of the effective date of the NOC.

**Complete the form** Type or print clearly, using ink and not markers or pencil. Answer each item or enter “NA,” for not applicable, if a particular item does not fit the circumstances or characteristics of your construction site or activity. If you need additional space, attach a separate piece of paper to the NOI form. **The NOI will be considered incomplete without a permit fee, a map, and the SWPPP.**

**Describe and locate the project** Use the legal or official name of the construction site. If a construction site lacks street name or route number, give the most accurate geographic information available to describe the location (reference to adjacent highways, roads and structures; e.g. intersection of state highways 70 and 100). Latitude and longitude (expressed in decimal degrees) of the center of the site can be located on USGS quadrangle maps. The quadrangle maps can be obtained at the USGS World Wide Web site: <http://www.usgs.gov/>; latitude and longitude information can be found at numerous other web sites. Attach a copy of a portion of a 7.5 minute quad map, showing location of site, with boundaries at least one mile outside the site boundaries. Provide estimated starting date of clearing activities and completion date of the project, and an estimate of the number of acres of the site on which soil will be disturbed, including borrow areas, fill areas, stockpiles and the total acres. For linear projects, give location at each end of the construction area.

**MS4 Jurisdiction:** If this construction site is located within a Municipal Separate Storm Sewer System (MS4), please list name of MS4. A current list of MS4s in Tennessee may be found at [http://www.tn.gov/environment/wpc/stormh2o/docs/MS4s\\_Jan2012.pdf](http://www.tn.gov/environment/wpc/stormh2o/docs/MS4s_Jan2012.pdf)

**Give name of the receiving waters** Trace the route of stormwater runoff from the construction site and determine the name of the river(s), stream(s), creek(s), wetland(s), lake(s) or any other water course(s) into which the stormwater runoff drains. Note that the receiving water course may or may not be located on the construction site. If the first water body receiving construction site runoff is unnamed (“unnamed tributary”), determine the name of the water body that the unnamed tributary enters.

**ARAP permit may be required** **If your work will disturb or cause alterations of a stream or wetland, you must obtain an appropriate Aquatic Resource Alteration Permit (ARAP).** If you have a question about the ARAP program or permits, contact your local Environmental Field Office (EFO).

**Submitting the form and obtaining more information** Note that this form must be signed by the company President, Vice-President, or a ranking elected official in the case of a municipality, for details see subpart 2.5. For more information, contact your local EFO at the toll-free number 1-888-891-8332 (TDEC). Submit the completed NOI form (keep a copy for your records) to the appropriate EFO for the county(ies) where the construction activity is located, addressed to **Attention: Stormwater NOI Processing.**

EFO	Street Address	Zip Code	EFO	Street Address	Zip Code
Memphis	8383 Wolf Lake Drive, Bartlett	38133-4119	Cookeville	1221 South Willow Ave.	38506
Jackson	1625 Hollywood Drive	38305-4316	Chattanooga	540 McCallie Avenue STE 550	37402-2013
Nashville	711 R S Gass Boulevard	37243	Knoxville	3711 Middlebrook Pike	37921
Columbia	1421 Hampshire Pike	38401	Johnson City	2305 Silverdale Road	37601

**APPENDIX B – Notice of Termination (NOT) Form**  
(next page)





**TENNESSEE DEPARTMENT OF ENVIRONMENT AND CONSERVATION (TDEC)**

Division of Water Resources

6<sup>th</sup> Floor Annex, L&C Tower, 401 Church Street, Nashville, Tennessee 37243

1-888-891-8332 (TDEC)

**Notice of Termination (NOT) for General NPDES Permit for Stormwater Discharges from Construction Activities (CGP)**

This form is required to be submitted when requesting termination of coverage from the CGP. The purpose of this form is to notify the TDEC that either all stormwater discharges associated with construction activity from the portion of the identified facility where you, as an operator, have ceased or have been eliminated; or you are no longer an operator at the construction site. Submission of this form shall in no way relieve the permittee of permit obligations required prior to submission of this form. Please submit this form to the local WPC Environmental Field Office (EFO) address (see table below). For more information, contact your local EFO at the toll-free number 1-888-891-8332 (TDEC).

**Type or print clearly, using ink.**

<b>Site or Project Name:</b>	<b>NPDES Tracking Number: TNR</b>
Street Address or Location:	County(ies):

<b>Name of Permittee Requesting Termination of Coverage:</b>			
Permittee Contact Name:		Title or Position:	
Mailing Address:		City:	State: Zip:
Phone: (      )		E-mail:	

**Check the reason(s) for termination of permit coverage:**

<input type="checkbox"/>	Stormwater discharge associated with construction activity is no longer occurring and the permitted area has a uniform 70% permanent vegetative cover OR has equivalent measures such as rip rap or geotextiles, in areas not covered with impervious surfaces.
<input type="checkbox"/>	You are no longer the operator at the construction site (i.e., termination of site-wide, primary or secondary permittee coverage).

**Certification and Signature:** (must be signed by president, vice-president or equivalent ranking elected official)

I certify under penalty of law that either: (a) all stormwater discharges associated with construction activity from the portion of the identified facility where I was an operator have ceased or have been eliminated or (b) I am no longer an operator at the construction site. I understand that by submitting this notice of termination, I am no longer authorized to discharge stormwater associated with construction activity under this general permit, and that discharging pollutants in stormwater associated with construction activity to waters of the United States is unlawful under the Clean Water Act where the discharge is not authorized by a NPDES permit. I also understand that the submittal of this notice of termination does not release an operator from liability for any violations of this permit or the Clean Water Act.

For the purposes of this certification, elimination of stormwater discharges associated with construction activity means that all stormwater discharges associated with construction activities from the identified site that are authorized by a NPDES general permit have been eliminated from the portion of the construction site where the operator had control. Specifically, this means that all disturbed soils at the portion of the construction site where the operator had control have been finally stabilized, the temporary erosion and sediment control measures have been removed, and/or subsequent operators have obtained permit coverage for the site or portions of the site where the operator had control.

I certify under penalty of law that this document and all attachments were prepared by me, or under my direction or supervision. The submitted information is to the best of my knowledge and belief, true, accurate, and complete. I am aware that there are significant penalties for submitting false information, including the possibility of fine and imprisonment. As specified in Tennessee Code Annotated Section 39-16-702(a)(4), this declaration is made under penalty of perjury.

Permittee name (print or type):	Signature:	Date:
---------------------------------	------------	-------

EFO	Street Address	Zip Code	EFO	Street Address	Zip Code
Memphis	8383 Wolf Lake Drive, Bartlett, TN	38133	Cookeville	1221 South Willow Ave.	38506
Jackson	1625 Hollywood Drive	38305	Chattanooga	540 McCallie Avenue STE 550	37402
Nashville	711 R S Gass Boulevard	37243	Knoxville	3711 Middlebrook Pike	37921
Columbia	1421 Hampshire Pike	38401	Johnson City	2305 Silverdale Road	37601

**APPENDIX C – Twice-Weekly Inspection Report Form**  
(next page)



**TENNESSEE DEPARTMENT OF ENVIRONMENT AND CONSERVATION (TDEC)**  
 Division of Water Resources  
 6<sup>th</sup> Floor Annex, L&C Tower, 401 Church Street, Nashville, Tennessee 37243  
 1-888-891-8332 (TDEC)  
**General NPDES Permit for Stormwater Discharges from Construction Activities (CGP)**

**Construction Stormwater Inspection Certification (Twice-Weekly Inspections)**

<b>Site or Project Name:</b>		<b>NPDES Tracking Number: TNR</b>	
Primary Permittee Name:		Date of Inspection:	
Current approximate disturbed acreage:	Has rainfall been checked/documented daily? <input type="checkbox"/> Yes <input type="checkbox"/> No	Name of Inspector:	
Current weather conditions:		Inspector's TNEPSC Certification Number:	

**Please check the box if the following items are on-site:**

- Notice of Coverage (NOC)     
  Stormwater Pollution Prevention Plan (SWPPP)     
  Twice-weekly inspection documentation  
 Site contact information     
  Rain Gage     
  Off-site Reference Rain Gage Location: \_\_\_\_\_

**Best Management Practices (BMPs):**

<b>Are the Erosion Prevention and Sediment Controls (EPSCs) functioning correctly:</b> If "No," describe below in Comment Section		
1. Are all applicable EPSCs installed and maintained per the SWPPP?	<input type="checkbox"/> Yes	<input type="checkbox"/> No
2. Are EPSCs functioning correctly at all disturbed areas/material storage areas per section 4.1.5?	<input type="checkbox"/> Yes	<input type="checkbox"/> No
3. Are EPSCs functioning correctly at outfall/discharge points such that there is no objectionable color contrast in the receiving stream, and no other water quality impacts per section 5.3.2?	<input type="checkbox"/> Yes	<input type="checkbox"/> No
4. Are EPSCs functioning correctly at ingress/egress points such that there is no evidence of track out?	<input type="checkbox"/> Yes	<input type="checkbox"/> No
5. If applicable, have discharges from dewatering activities been managed by appropriate controls per section 4.1.4? If "No," describe below the measures to be implemented to address deficiencies.	<input type="checkbox"/> Yes	<input type="checkbox"/> No
6. If construction activity at any location on-site has temporarily/permanently ceased, was the area stabilized within 14 days per section 3.5.3.2? If "No," describe below each location and measures taken to stabilize the area(s).	<input type="checkbox"/> Yes	<input type="checkbox"/> No
7. Have pollution prevention measures been installed, implemented, and maintained to minimize the discharge of pollutants from equipment and vehicle washing, wheel wash water, and other wash waters per section 4.1.5? If "No," describe below the measures to be implemented to address deficiencies.	<input type="checkbox"/> Yes	<input type="checkbox"/> No
8. If a concrete washout facility is located on site, is it clearly identified on the project and maintained? If "No," describe below the measures to be implemented to address deficiencies.	<input type="checkbox"/> N/A	<input type="checkbox"/> Yes <input type="checkbox"/> No
9. Have all previous deficiencies been addressed? If "No," describe the remaining deficiencies in the Comments section. <input type="checkbox"/> Check if deficiencies/corrective measures have been reported on a previous form.	<input type="checkbox"/> Yes	<input type="checkbox"/> No
Comment Section. If the answer is "No" for any of the above, please describe the problem and corrective actions to be taken. Otherwise, describe any pertinent observations:		

**Certification and Signature** (must be signed by the certified inspector and the permittee per Sections 3.5.8.2 (g) and 7.7.2 of the CGP)

I certify under penalty of law that this document and all attachments were prepared by me, or under my direction or supervision. The submitted information is to the best of my knowledge and belief, true, accurate, and complete. I am aware that there are significant penalties for submitting false information, including the possibility of fine and imprisonment. As specified in Tennessee Code Annotated Section 39-16-702(a)(4), this declaration is made under penalty of perjury.

Inspector Name and Title:	Signature:	Date:
Primary Permittee Name and Title:	Signature:	Date:

## Construction Stormwater Inspection Certification Form (Twice-Weekly Inspections)

### **Purpose of this form/ Instructions**

An inspection, as described in section 3.5.8.2. of the General Permit for Stormwater Discharges from Construction Activities (“Permit”), shall be performed at least twice every calendar week and documented on this form. Inspections shall be performed at least 72 hours apart. Where sites or portion(s) of construction sites have been temporarily stabilized, or runoff is unlikely due to winter conditions (e.g., site covered with snow or ice), such inspection only has to be conducted once per month until thawing results in runoff or construction activity resumes.

Inspectors performing the required twice weekly inspections must have an active certification by completing the “Fundamentals of Erosion Prevention and Sediment Control Level I” course. (<http://www.tnepsc.org/>). A copy of the certification or training record for inspector certification should be kept on site.

Qualified personnel, as defined in section 3.5.8.1 of the Permit (provided by the permittee or cooperatively by multiple permittees) shall inspect disturbed areas of the construction site that have not been finally stabilized, areas used for storage of materials that are exposed to precipitation, structural control measures, locations where vehicles enter or exit the site, and each outfall.

Disturbed areas and areas used for storage of materials that are exposed to precipitation shall be inspected for evidence of, or the potential for, pollutants entering the site’s drainage system. Erosion prevention and sediment control measures shall be observed to ensure that they are operating correctly.

Outfall points (where discharges leave the site and/or enter waters of the state) shall be inspected to determine whether erosion prevention and sediment control measures are effective in preventing significant impacts to receiving waters. Where discharge locations are inaccessible, nearby downstream locations shall be inspected. Locations where vehicles enter or exit the site shall be inspected for evidence of offsite sediment tracking.

Based on the results of the inspection, any inadequate control measures or control measures in disrepair shall be replaced or modified, or repaired as necessary, before the next rain event if possible, but in no case more than 7 days after the need is identified.

Based on the results of the inspection, the site description identified in the SWPPP in accordance with section 3.5.1 of the Permit and pollution prevention measures identified in the SWPPP in accordance with section 3.5.2 of the Permit, shall be revised as appropriate, but in no case later than 7 days following the inspection. Such modifications shall provide for timely implementation of any changes to the SWPPP, but in no case later than 14 days following the inspection.

All inspections shall be documented on this Construction Stormwater Inspection Certification form. Alternative inspection forms may be used as long as the form contents and the inspection certification language are, at a minimum, equivalent to the division’s form and the permittee has obtained a written approval from the division to use the alternative form. Inspection documentation will be maintained on site and made available to the division upon request. Inspection reports must be submitted to the division within 10 days of the request.

Trained certified inspectors shall complete inspection documentation to the best of their ability. Falsifying inspection records or other documentation or failure to complete inspection documentation shall result in a violation of this permit and any other applicable acts or rules.

(This page intentionally left blank)

The following SWPPP development outline is provided to give SWPPP designers guidance for preparing SWPPPs. Note that not all site scenarios are contained in the checklist. However, the information in the checklist provides an excellent foundation upon which to build a comprehensive Stormwater Pollution Prevention Plan. A designer is responsible for fully understanding the requirements of the TN CGP, the TDEC EPSC Handbook and good engineering practices related to stormwater management on construction projects.

---

**General Information/Narrative**

---

- Provide a description of all construction activities at the site (utilities, cutting and filling, roadway construction, etc.). Describe the extent of cutting and/or filling activities at the site.
- Provide the total acreage to be permitted. Include a description of phases to keep the disturbed acreage at the project under 50 acres of total disturbance at any one time. Include a description of borrow and waste sites. Off-site borrow and waste areas must be included in the permitted acreage calculation unless the offsite borrow or waste area has been separately permitted.
- Provide contact information for the primary permit holder and any secondary permit holders. As operators are added to the site, they must be added as permit holders as well.
- Clearly provide the location of the site and any borrow/waste activities. Provide a USGS quadrangle showing the location of the site and waste and borrow areas. For the project site, show the locations of the outfalls on the quad map and correlate with the SWPPP.
- Provide a description of the site conditions prior to disturbance and after development has been completed. Estimate the amount of managed open space, forested, and built upon land at the site prior to and after development.
- Describe the soils at the site. Identify acid producing soils, hydric soils, highly erodible soils and soils with a high clay content. Consider soil characteristics in the design.
- Provide a calculation of the runoff coefficient of the site after construction activities are completed and how the runoff will be handled to prevent erosion at the permanent outfall(s).
- Provide a list of possible chemicals stored on the project. Indicate the types of pollution prevention measures that will be included on the project, including the person's title that will be responsible for overseeing pollution prevention on the site.
- For projects that have separate and common stormwater features, such as residential developments or industrial parks, the developer/owner must describe how they will prevent erosion and/or control any sediment from portions of the property that will be sold prior to completion of construction; once the property is sold, the new operator must obtain coverage under the CGP, and assume operational control and responsibility of that portion of the site. If instead new owners desire separate coverage and to operate under a separate SWPPP, the new owner must clearly demonstrate how the new SWPPP and original SWPPP will not cause conflicting stormwater management issues.

---

**EPSC Plan Information**

---

- If the project disturbs less than 5 acres, provide at least two separate EPSC plan sheets. At least two phases shall be identified, with associated EPSC staging addressed. The plan phases shall be addressed separately in plan sheets, with each phase reflecting the conditions and measures



necessary to manage stormwater runoff and EPSC during the initial land disturbance (initial grading) and at final grading.

- If the project disturbs more than 5 acres total, provide at least 3 separate EPSC plan sheets. Three phases shall be identified. The first plan sheet should reflect the conditions and measures necessary to manage stormwater runoff and EPSC, during the initial land disturbance (initial grading). The second plan sheet shall reflect the conditions and measures necessary to manage stormwater runoff and EPSC from interim land disturbance activities. The third plan sheet shall reflect the conditions and measures necessary to manage stormwater runoff and EPSC at final grading.
- Identify all outfalls from the project. Provide unique labels for each outfall. Provide a summary table that identifies the total drainage area, disturbed drainage area, and diverted drainage area (run-on that will not drain to the outfall) to each outfall. The table must indicate the name of the feature to which the outfall drains (e.g. stream, wet weather conveyance, lake).
- Show the approximate location for each EPSC or pollution prevention measure. Include standard symbols referenced in the TDEC EPSC Handbook. Provide standard details with specific sizes and construction materials, based upon the supporting calculations where appropriate.
- Identify on the plans the locations of the ARAP boundaries and reference the ARAP. For sites where stream diversions are necessary, show specific sequencing related to the construction of the diversion, the active construction in the natural channel, dewatering, and turning the stream back into the natural channel.
- Identify areas not to be disturbed by construction clearly on the plans, including stream buffers. Include specifications in the plan for how to delineate these areas, such as the installation of high visibility fencing or signage along the outer most edge of the buffer.
- Identify sinkholes on the plans and specify measures during construction and after construction to protect water quality and the integrity of the sinkhole.
- Provide a comprehensive legend, north arrow and scale.
- Clearly indicate the boundaries of the area to be covered by the permit. Also clearly indicated the areas that are not to be disturbed.
- Include topographic information to support the SWPPP design. The topographic information should extend to encompass the watersheds that contribute to the outfalls from the proposed site. This information should be used in determining the **total** drainage area (as opposed to the onsite disturbed drainage area).
- For sites that drain to Impaired (for sediment or habitat alteration) or Exceptional Tennessee Waters, measures must be designed for the 5-yr, 24-hr design storm. Provide a summary of supporting calculations to show the design criteria has been met. In addition, outfalls that have 5 acres or more of drainage are required to have a sediment basin or equivalent measure(s). If equivalent measure(s) are to be used, equivalency must be verified through design. Calculations for basin volumes must be included in the SWPPP.
- For all other sites, measures must be designed for the 2-yr, 24-hr storm event. Provide a summary of supporting calculations to show the design criteria has been met. In addition, outfalls that have 10 acres or more of drainage are required to have a sediment basin or equivalent

measure(s). If equivalent measure(s) are to be used, equivalency must be verified through design. Calculations for basin volumes must be included in the SWPPP.

- Provide internal and perimeter sediment controls and erosion prevention measures at all pipe outlets. Provide measures to protect adjacent or downstream wetlands, streams and other environmentally sensitive areas.
- Divert run-on around the project with diversions, berms or other measures. Design structural controls based upon the drainage area, disturbed area, slope and soils. When clay and other fine particle soils are present at the construction site, chemical treatment may be used in accordance with soil testing and the manufacturer's requirements to reduce turbidity in the runoff being discharged from the project.
- For steep slope sites, the SWPPP must include a description of measures that will be installed to dissipate the volume and energy of the stormwater runoff to pre-development levels. Multiple stormwater "turnouts" should be provided to keep slope lengths short and therefore keep the erosion potential lower. Each turnout must have erosion prevention addressed with outlet protection.
- Clearly indicate locations of stockpiles on the project, such as topsoil stockpiles. Provide EPSC controls around the stockpile area.
- If permanent stormwater management controls are included in the project, clearly locate the permanent control(s) and include the installation of the permanent measures in the construction sequence. Typically, permanent controls are not installed until the drainage area they serve has been completely stabilized.

### **Environmentally Sensitive Areas Information**

- Provide a description of the receiving stream – Is it impaired, an Exceptional TN Water, an Outstanding National Resource Water? Is it covered by a TMDL? If so, how will the SWPPP address these issues?
  - Will any streams be relocated, crossed (even temporarily) or piped as a part of this project? If so, an ARAP and COE permit are likely required. These permits must be obtained prior to submitting the NOI.
  - Show the original location of the stream as well as the proposed realignment, piped section or mitigated section of the stream on the plans with associated control measures required by the ARAP or COE permit.
- Does the project site or the receiving stream have state or federally listed threatened or endangered species or critical habitat?
  - If so, the US Fish and Wildlife Services must be consulted for federal listings. The TDEC Natural Heritage Program must be consulted for state listed species.
  - Include any restrictions on work area or schedule in the plans, as required by USF&W or TDEC.
- Are there any wetlands on or adjacent to the project?
  - Locate wetland on the plans.
  - Include measures on the plans to protect the wetlands.
  - If they will be impacted by the project, an ARAP or COE permit may be required. These permits must be obtained prior to submitting the NOI.

---

**Pollution Prevention Measures**

---

- Identify the location(s) of the concrete washout area on site. Include a standard note to provide adequate signage on the project indicating the area as the concrete washout area.
- All chemicals and soluble materials stored onsite must either be stored in an enclosed, waterproof storage facility or provided with secondary containment capable of storing the contents of the total amount of chemicals stored. Spill cleanup materials must be located within the immediate proximity of the materials as well. All of this information must be included on the plans and in the written narrative of the SWPPP.
- Indicate the location of port-a-potties on the project. They should not be located close to streams, wetlands or storm drains.
- If maintenance is to be performed on vehicles on the site, the location of the maintenance area(s) must be indicated on the plans. Provide a listing in the SWPPP of pollution prevention best practices tools that should be used with vehicle maintenance activities, such as drip pans for oil drips and changes, oil recycling facilities, spill cleanup materials, and containers for recycling or disposing of other lubricants or oils related to vehicle maintenance and cleaning.
- Provide an area for the storage of construction related materials and debris. For trash on the project, a trash receptacle with a lid is required.
- Provide a description of any discharge associated with industrial activity other than construction stormwater that originates on site and the location of that activity and its permit number.

*This Appendix is currently under construction.*

The following example problem is for the design of a rip rap lined channel. This design is based upon U.S. Department of Transportation – Federal Highway Administration: Hydraulic Engineering Circular Number 15 (HEC15) and involves an iterative process. Note that many designs typically have design constraints such as limited easement width or right of way. Each design must be consistent with the site layout and must clearly address the design constraints.

**GIVEN:**

Design a rip rap lined channel to non-erosively convey the 5 year storm event.

$$Q_5 = 17.4 \text{ cfs}$$

$$3:1 \text{ side slopes } (Z = 3)$$

$$S = 8\% = 0.08$$

Trapezoidal Shape

**REQUIRED:**

Determine the required riprap  $D_{50}$  through an iterative process. Then compare the required  $D_{50}$  size to the trial  $D_{50}$  size. If  $D_{50} \text{ required} < \text{trial } D_{50}$  then the rip rap size is adequate. However, a smaller more cost effective rip rap size should be considered if the trial  $D_{50} \geq 110\%$  of the required  $D_{50}$ .

**SOLUTION:****Step 1:**

$$Q = 17.4 \text{ cfs}$$

$$S = 8\% = 0.08$$

$$Z = \frac{e}{d} = 3$$

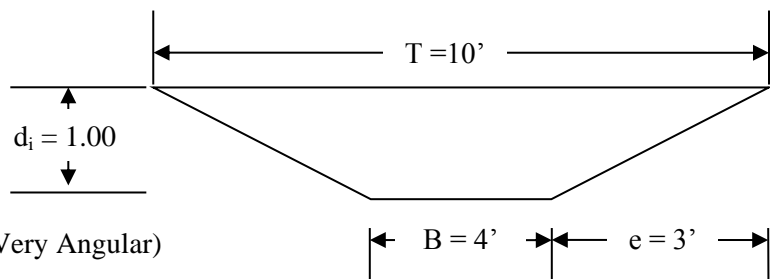
**Step 2:**

$$\text{Trial } D_{50} = 1.25' \text{ (Very Angular)}$$

**Step 3:**

$$d_i = 1.00 \text{ ft}$$

$$A = Bd + Zd^2 = 7.00 \text{ sq ft}$$

$$T = B + 2dZ = 10.00 \text{ ft}$$

$$R = \frac{bd + Zd^2}{b + 2d\sqrt{Z^2 + 1}} = 0.68 \text{ ft}$$

$$d_a = A/T = 0.70 \text{ ft}$$

$$A_a = Bd + Zd^2 = 4.27 \text{ sq ft}$$

$$T_a = B + 2dZ = 8.20 \text{ ft}$$

$$R_a = \frac{bd + Zd^2}{b + 2d\sqrt{Z^2 + 1}} = 0.51 \text{ ft}$$

**Step 4:**

$$d_a/D_{50} = 0.56 \leq 1.5 \text{ therefore use Equation 7.27-4}$$

$$n = \frac{\alpha d_a^{1/6}}{\sqrt{g} f(Fr) f(REG) f(CG)} = 0.078$$

$$b = 1.14 \left(\frac{D_{50}}{T_a}\right)^{0.453} \left(\frac{d_a}{D_{50}}\right)^{0.814} = 0.303$$

$$v = Q/A_a = 4.075 \text{ ft/sec}$$

$$Fr = \frac{v}{\sqrt{g d_a}} = 0.858$$

$$f(Fr) = \left(\frac{0.28Fr}{b}\right)^{\log(0.755/b)} = 0.912$$

$$f(REG) = 3.434 \left( \frac{T_a}{D_{50}} \right)^{0.492} b^{1.025} \left( \frac{T_a}{D_{50}} \right)^{0.118} = 7.363$$

$$f(CG) = \left( \frac{T_a}{d_a} \right)^{-b} = 0.474$$

Note: Subcritical flow, Froude Number (Fr) less than 1, which is desirable. Now check trial flow.

**Step 5:**  $Q = \frac{1.49}{n} A_a R_a^{\frac{2}{3}} S^{\frac{1}{2}} = 14.72 \text{ cfs}$

This flow is not within 5% of 17.4 cfs; therefore return to step 3 and select a new depth ( $d_{i+1}$ ).

**Step 3(2):** Using equation 7.27-2 obtain a new  $d_i$  ( $d_{i+1}$ ):

$$d_{i+1} = d_i \left( \frac{Q}{Q_i} \right)^{0.4} = 1.07 \text{ ft}$$

$d_{i+1} = 1.07 \text{ ft}$	$d_a = A/T = 0.74 \text{ ft}$
$A = Bd + Zd^2 = 7.72 \text{ sq ft}$	$A_a = Bd + Zd^2 = 4.61 \text{ sq ft}$
$T = B + 2dZ = 10.42 \text{ ft}$	$T_a = B + 2dZ = 8.44 \text{ ft}$
$R = \frac{bd + Zd^2}{b + 2d\sqrt{Z^2 + 1}} = 0.72 \text{ ft}$	$R_a = \frac{bd + Zd^2}{b + 2d\sqrt{Z^2 + 1}} = 0.53 \text{ ft}$

**Step 4(2):**  $d_a/D_{50} = 0.59 \leq 1.5$  therefore use Equation 7.27-4

$$n = \frac{\alpha d_a^{1/6}}{\sqrt{g} f(Fr) f(REG) f(CG)} = 0.080$$

$$b = 1.14 \left( \frac{D_{50}}{T_a} \right)^{0.453} \left( \frac{d_a}{D_{50}} \right)^{0.814} = 0.313$$

$$v = Q/A_a = 3.778 \text{ ft/sec}$$

$$Fr = \frac{v}{\sqrt{g} d_a} = 0.774$$

$$f(Fr) = \left( \frac{0.28Fr}{b} \right)^{\log(0.755/b)} = 0.869$$

$$f(REG) = 3.434 \left( \frac{T_a}{D_{50}} \right)^{0.492} b^{1.025} \left( \frac{T_a}{D_{50}} \right)^{0.118} = 7.746$$

$$f(CG) = \left( \frac{T_a}{d_a} \right)^{-b} = 0.466$$

**Step 5(2):**  $Q = \frac{1.49}{n} A_a R_a^{\frac{2}{3}} S^{\frac{1}{2}} = 15.99 \text{ cfs}$



This flow is not within 5% of 17.4 cfs; therefore return to step 3 and select a new depth ( $d_{i+2}$ )

**Step 3(3):** Using equation 7.27-2 obtain a new  $d_i$  ( $d_{i+2}$ ):

$$d_{i+2} = d_{i+1} \left( \frac{Q}{Q_i} \right)^{0.4} = 1.11 \text{ ft}$$

$$d_{i+2} = 1.11 \text{ ft} \quad d_a = A/T = 0.76 \text{ ft}$$

$$A = Bd + Zd^2 = 8.14 \text{ sq ft} \quad A_a = Bd + Zd^2 = 4.80 \text{ sq ft}$$

$$T = B + 2dZ = 10.66 \text{ ft} \quad T_a = B + 2dZ = 8.58 \text{ ft}$$

$$R = \frac{bd + Zd^2}{b + 2d\sqrt{Z^2 + 1}} = 0.74 \text{ ft} \quad Ra = \frac{bd + Zd^2}{b + 2d\sqrt{Z^2 + 1}} = 0.54 \text{ ft}$$

**Step 4(3):**  $d_a/D_{50} = 0.61 \leq 1.5$  therefore use Equation 7.27-4

$$n = \frac{\alpha d_a^{1/6}}{\sqrt{g} f(Fr) f(REG) f(CG)} = 0.080$$

$$b = 1.14 \left( \frac{D_{50}}{T_a} \right)^{0.453} \left( \frac{d_a}{D_{50}} \right)^{0.814} = 0.319$$

$$v = Q/A_a = 3.624 \text{ ft/sec}$$

$$Fr = \frac{v}{\sqrt{g d_a}} = 0.731$$

$$f(Fr) = \left( \frac{0.28Fr}{b} \right)^{\log(0.755/b)} = 0.847$$

$$f(REG) = 3.434 \left( \frac{T_a}{D_{50}} \right)^{0.492} b^{1.025} \left( \frac{T_a}{D_{50}} \right)^{0.118} = 7.963$$

$$f(CG) = \left( \frac{T_a}{d_a} \right)^{-b} = 0.462$$

**Step 5(3):**  $Q = \frac{1.49}{n} A_a R_a^{\frac{2}{3}} S_f^{\frac{1}{2}} = 16.75 \text{ cfs}$

This flow is within 5% of 17.4 cfs, therefore go to Step 6.

**Step 6:**  $R_e = \frac{\sqrt{gd} S D_{50}}{v} = 185117 = 1.85 \cdot 10^5$

Note: The “d” used here is  $d_a$  + minimum freeboard of 0.5’

From Figure 7.27-4:

$$SF = 1.45$$

$$F^* = 0.14$$

From Figure 7.27-4 interpolation or chart below:

$$SF = ((R_e - 40,000) * (3.125 * 10^{-6})) + 1$$

$$= ((1.85 * 10^5 - 40,000) * (3.125 * 10^{-6})) + 1 = 1.45$$

$$F^* = ((R_e - 40000) * (6.4375 * 10^{-7})) + 0.047$$

$$= ((1.85 * 10^5 - 40000) * (6.4375 * 10^{-7})) + 0.047 = 0.14$$

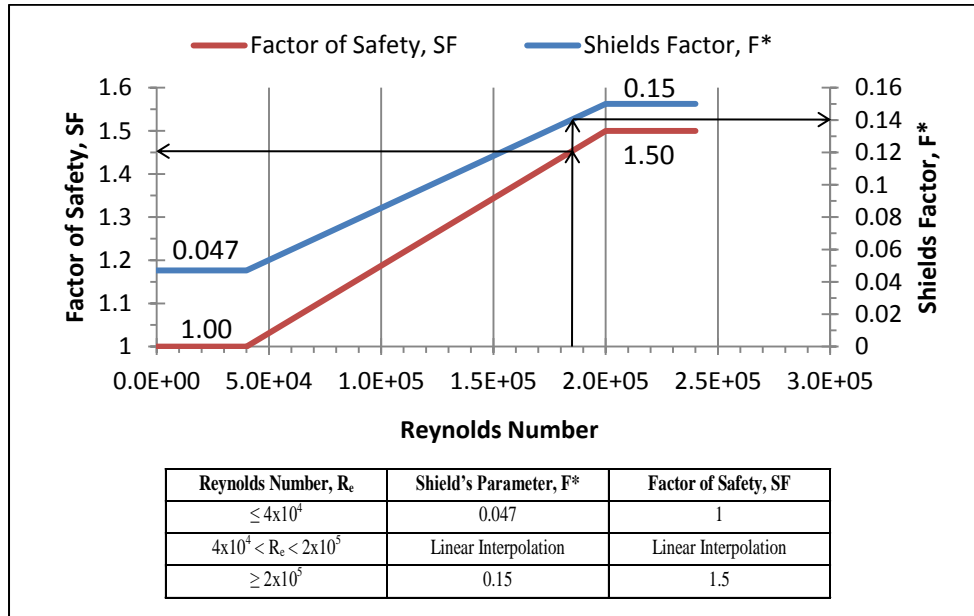

**Step 7:**

Since slope is between 5% and 10%, use both Equation 7.27-11 and Equation 7.27-12 and choose the larger outcome.

Equation 7.27-11:

$$D_{50} \geq \frac{SF d S}{F^* (\gamma_s - \gamma)} = 0.64 \text{ ft}$$

$$d = d_a + \text{minimum freeboard of } 0.5'$$

$\gamma_s$  = specific weight of rock was assumed to be 165 lb/ft<sup>3</sup>

$\gamma$  = specific weight of water, 62.4 lb/ft<sup>3</sup>

Equation 7.27-12:

$$D_{50} \geq \frac{SF d S \Delta}{F^* (\gamma_s - \gamma)} = 0.82 \text{ ft}$$

$$\tau_s = \gamma d_a S_o = 3.81 \text{ lb/ft}^2$$

$$\eta = \frac{\tau_s}{F^* (\gamma_s - \gamma) D_{50}} = 0.211$$

Note: The  $D_{50}$  used here is the trial  $D_{50}$  (1.25').

$$\beta = \tan^{-1} \left( \frac{\cos \alpha}{\frac{2 \sin \theta}{\eta \tan \phi} + \sin \alpha} \right) = 16.33^\circ$$

$$\alpha = \tan^{-1}(S) = \tan^{-1}(0.08) = 4.57^\circ$$

$$\theta = \tan^{-1}(1/Z) = \tan^{-1}(1/3) = 18.44^\circ$$

$\phi = 42^\circ$  (From Figure 7.27-5 using the trial  $D_{50}$  size (1.25') and Very Angular)

$$\Delta = \frac{K_1(1+\sin(\alpha+\beta)) \tan \phi}{2(\cos \theta \tan \phi - SF \sin \theta \cos \beta)} = 1.284$$

$$K_1 = 0.066Z + 0.67 = 0.066(3) + 0.67 = 0.868$$

$$\begin{aligned} \text{Note: } K_1 &= .77 \quad (Z \leq 1.5) \\ &= 0.066Z + 0.67 \quad (1.5 < Z < 5) \\ &= 1.0 \quad (Z \geq 5) \end{aligned}$$

Therefore the required  $D_{50}$  size is 0.82 ft.

### **Step 8:**

Compare the required  $D_{50}$  to the trial size selected in Step 2. If the trial size is smaller than the required size, it is unacceptable for the design. Repeat the procedure from Step 2, selecting a larger trial size. If the trial size is larger than the required  $D_{50}$ , then the design is acceptable. However, if the required  $D_{50}$  is sufficiently smaller than the trial size, the procedure may be repeated from Step 2 with a smaller, more cost-effective stone size.

In the design example, the trial  $D_{50}$  is larger than the required  $D_{50}$  therefore the design is acceptable. However since it is significantly larger than the required  $D_{50}$ , return to Step 2 using the previous iteration's required  $D_{50}$  of 0.82 ft as the new trial  $D_{50}$ .

### **Step 2(2):**

Trial  $D_{50} = 0.82'$  (Very Angular)

### **Step 3(4):**

$$\begin{aligned} d_i &= 1.00 \text{ ft} & A_a &= Bd + Zd^2 = 4.27 \text{ sq ft} \\ A &= Bd + Zd^2 = 7.00 \text{ sq ft} & T_a &= B + 2dZ = 8.20 \text{ ft} \\ T &= B + 2dZ = 10.00 \text{ ft} & R_a &= \frac{bd + Zd^2}{b + 2d\sqrt{Z^2 + 1}} = 0.51 \text{ ft} \\ R &= \frac{bd + Zd^2}{b + 2d\sqrt{Z^2 + 1}} = 0.68 \text{ ft} \end{aligned}$$

$$d_a = A/T = 0.70 \text{ ft}$$

### **Step 4(4):**

$d_a/D_{50} = 0.85 \leq 1.5$  therefore use Equation 7.27-4

$$n = \frac{\alpha d_a^{1/6}}{\sqrt{g} f(Fr) f(REG) f(CG)} = 0.065$$

$$b = 1.14 \left( \frac{D_{50}}{T_a} \right)^{0.453} \left( \frac{d_a}{D_{50}} \right)^{0.814} = 0.353$$

$$v = Q/A_a = 4.075 \text{ ft/sec}$$

$$f(REG) = 3.434 \left(\frac{T_a}{D_{50}}\right)^{0.492} b^{1.025} \left(\frac{T_a}{D_{50}}\right)^{0.118} = 10.29$$

$$Fr = \frac{v}{\sqrt{g d_a}} = 0.858$$

$$f(Fr) = \left(\frac{0.28Fr}{b}\right)^{\log(0.755/b)} = 0.881$$

$$f(CG) = \left(\frac{T_a}{d_a}\right)^{-b} = 0.419$$

**Step 5(4):**  $Q = \frac{1.49}{n} A_a R_a^{\frac{2}{3}} S_f^{\frac{1}{2}} = 17.56 \text{ cfs}$

This flow is within 5% of 17.4 cfs; therefore go to Step 6.

**Step 6:**  $R_e = \frac{\sqrt{g d_a S} D_{50}}{v} = 118000 = 1.18 * 10^5$

Note: The “d” that is used here is  $d_a$  + minimum freeboard of 0.5’

From Figure 7.27-4:

$$SF = 1.24$$

$$F^* = 0.098$$

From Figure 7.27-4 interpolation:

$$\begin{aligned} SF &= ((R_e - 40,000) * (3.125 * 10^{-6})) + 1 \\ &= ((1.18 * 10^5 - 40,000) * (3.125 * 10^{-6})) + 1 = 1.245 \end{aligned}$$

$$\begin{aligned} F^* &= ((R_e - 40000) * (6.4375 * 10^{-7})) + 0.047 \\ &= ((1.18 * 10^5 - 40000) * (6.4375 * 10^{-7})) + 0.047 = 0.098 \end{aligned}$$

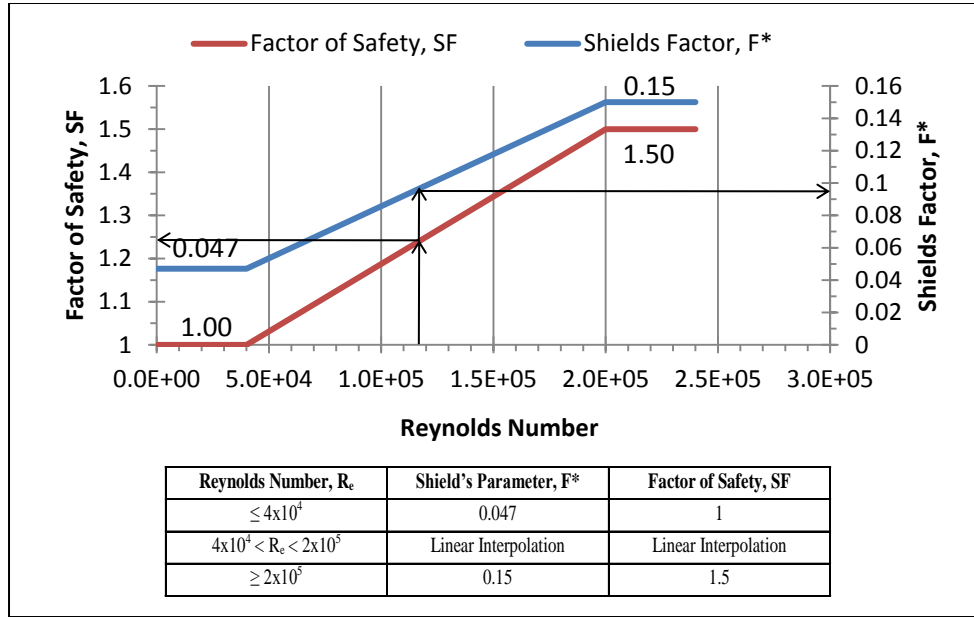

**Step 7:**

Since slope is between 5% and 10% we must use both Equation 7.27-12 and Equation 7.27-13 and choose the larger outcome.

Equation 7.27-11:

$$D_{50} \geq \frac{SF \, d \, S}{F^* \left( \frac{\gamma_s}{\gamma} - 1 \right)} = 0.75 \text{ ft}$$

$$d = d_a + \text{minimum freeboard of } 0.5'$$

$$\gamma_s = \text{specific weight of rock was assumed to be } 165 \text{ lb/ft}^3$$

$$\gamma = \text{specific weight of water, } 62.4 \text{ lb/ft}^3$$

Equation 7.27-12:

$$D_{50} \geq \frac{SF \, d \, S \Delta}{F^* \left( \frac{\gamma_s}{\gamma} - 1 \right)} = 0.90 \text{ ft}$$

$$\tau_s = \gamma d_a S_o = 3.49 \text{ lb/ft}^2$$

$$\eta = \frac{\tau_s}{F^* (\gamma_s - \gamma) D_{50}} = 0.426$$

Note: The  $D_{50}$  that is used here is the trial  $D_{50}$  (0.82').

$$\beta = \tan^{-1} \left( \frac{\cos \alpha}{\frac{2 \sin \theta}{\eta \tan \phi} + \sin \alpha} \right) = 29.55^\circ$$

$$\alpha = \tan^{-1}(S) = \tan^{-1}(0.08) = 4.57^\circ$$

$$\theta = \tan^{-1}(1/Z) = \tan^{-1}(1/3) = 18.44^\circ$$

$\phi = 41.5^\circ$  (From Figure 7.27-5 using the trial  $D_{50}$  size (1.25') and Very Angular)

$$\Delta = \frac{K_1(1+\sin(\alpha+\beta)) \tan \phi}{2(\cos \theta \tan \phi - SF \sin \theta \cos \beta)} = 1.21$$

$$K_1 = 0.066Z + 0.67 = 0.066(3) + 0.67 = 0.868$$

$$\begin{aligned} \text{Note: } K_1 &= .77 \quad (Z \leq 1.5) \\ &= 0.066Z + 0.67 \quad (1.5 < Z < 5) \\ &= 1.0 \quad (Z \geq 5) \end{aligned}$$

Therefore the required  $D_{50}$  size is 0.90 ft.

**Step 8:**

The trial  $D_{50}$  is smaller than the required  $D_{50}$  therefore the design is unacceptable. Return to Step 2 and use the previous iteration's required  $D_{50}$  of 0.90 ft as the new trial  $D_{50}$ .

**Step 2(5):**

Trial  $D_{50} = 0.90'$  (Very Angular)

**Step 3(5):**

$$\begin{aligned} d_i &= 1.00 \text{ ft} & d_a &= A/T = 0.70 \text{ ft} \\ A &= Bd + Zd^2 = 7.00 \text{ sq ft} & A_a &= Bd + Zd^2 = 4.27 \text{ sq ft} \\ T &= B + 2dZ = 10.00 \text{ ft} & T_a &= B + 2dZ = 8.20 \text{ ft} \\ R &= \frac{bd + Zd^2}{b + 2d\sqrt{Z^2 + 1}} = 0.68 \text{ ft} & R_a &= \frac{bd + Zd^2}{b + 2d\sqrt{Z^2 + 1}} = 0.51 \text{ ft} \end{aligned}$$

**Step 4(5):**

$d_a/D_{50} = 0.78 \leq 1.5$  therefore use Equation 7.27-4

$$n = \frac{\alpha d_a^{1/6}}{\sqrt{g} f(Fr) f(REG) f(CG)} = 0.068$$

$$b = 1.14 \left(\frac{D_{50}}{T_a}\right)^{0.453} \left(\frac{d_a}{D_{50}}\right)^{0.814} = 0.341$$

$$v = Q/A_a = 4.08 \text{ ft/sec}$$

$$Fr = \frac{v}{\sqrt{g} d_a} = 0.858$$

$$f(Fr) = \left(\frac{0.28Fr}{b}\right)^{\log(0.755/b)} = 0.886$$

$$f(REG) = 3.434 \left(\frac{T_a}{D_{50}}\right)^{0.492} b^{1.025} \left(\frac{T_a}{D_{50}}\right)^{0.118} = 9.540$$

$$f(CG) = \left(\frac{T_a}{d_a}\right)^{-b} = 0.432$$

**Step 5(5):**

$$Q = \frac{1.49}{n} A_a R_a^2 S_f^{1/2} = 16.86 \text{ cfs}$$



This flow is within 5% of 17.4 cfs, therefore go to Step 6.

**Step 6(5):**  $R_e = \frac{\sqrt{gdS} D_{50}}{\nu} = 130000 = 1.30 \cdot 10^5$

Note: The “d” that is used here is  $d_a$  + minimum freeboard of 0.5’

From Figure 7.27-4:

SF = 1.28

F\* = 0.105

From Figure 7.27-4 interpolation:

$$SF = ((R_e - 40,000) * (3.125 \cdot 10^{-6})) + 1$$

$$= ((1.30 \cdot 10^5 - 40,000) * (3.125 \cdot 10^{-6})) + 1 = 1.28$$

$$F^* = ((R_e - 40000) * (6.4375 \cdot 10^{-7})) + 0.047$$

$$= ((1.30 \cdot 10^5 - 40000) * (6.4375 \cdot 10^{-7})) + 0.047 = 0.105$$

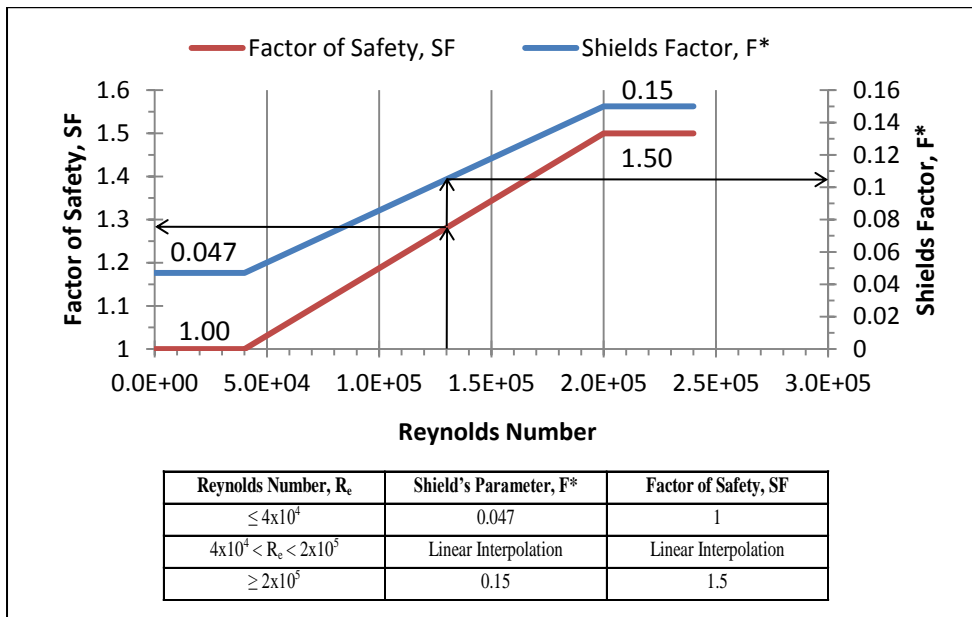

**Step 7(5):** Since slope is between 5% and 10%, we use both Equation 7.27-11 and Equation 7.27-12 and choose the larger outcome.

Equation 7.27-11:

$$D_{50} \geq \frac{SF d S}{F^* \left(\frac{\gamma_s}{\gamma} - 1\right)} = 0.71 \text{ ft}$$

$d = d_a$  + minimum freeboard of 0.5’

$\gamma_s =$  specific weight of rock was assumed to be 165 lb/ft<sup>3</sup>

$\gamma$  = specific weight of water, 62.4 lb/ ft<sup>3</sup>

Equation 7.27-12:

$$D_{50} \geq \frac{SF d S \Delta}{F^* \left( \frac{\gamma_s}{\gamma} - 1 \right)} = 0.86 \text{ ft}$$

$$\tau_s = \gamma d_a S_o = 3.494$$

$$\eta = \frac{\tau_s}{F^* (\gamma_s - \gamma) D_{50}} = 0.361$$

Note: The  $D_{50}$  that is used here is the trial  $D_{50}$  (0.90').

$$\beta = \tan^{-1} \left( \frac{\cos \alpha}{\frac{2 \sin \theta}{\eta \tan \phi} + \sin \alpha} \right) = 26.03^\circ$$

$$\alpha = \tan^{-1}(S) = \tan^{-1}(0.08) = 4.57^\circ$$

$$\theta = \tan^{-1}(1/Z) = \tan^{-1}(1/3) = 18.44^\circ$$

$\phi = 41.8^\circ$  (From Figure 7.27-5 using the trial  $D_{50}$  size (1.25') and Very Angular)

$$\Delta = \frac{K_1 (1 + \sin(\alpha + \beta)) \tan \phi}{2 (\cos \theta \tan \phi - SF \sin \theta \cos \beta)} = 1.21$$

$$K_1 = 0.066Z + 0.67 = 0.066(3) + 0.67 = 0.868$$

$$\begin{aligned} \text{Note: } K_1 &= .77 (Z \leq 1.5) \\ &= 0.066Z + 0.67 (1.5 < Z < 5) \\ &= 1.0 (Z \geq 5) \end{aligned}$$

**Therefore the required  $D_{50}$  size is 0.86ft.**

**Step 8(5): Specify Riprap with  $D_{50} = 12'' = 1'$  for this channel.**

The trial  $D_{50}$  is slightly larger than the required  $D_{50}$  which is preferable. Ideally the trial  $D_{50}$  will be no more than 10% larger than the required  $D_{50}$ . One can then use this  $D_{50}$  size to specify the appropriate common riprap size, which in this case would be riprap with a  $D_{50}$  of 12'' or 1'. The use of Excel is strongly recommended for performing these iterations.

The following example problem is for the design of a sediment basin and only addresses the hydraulic capacity and storage capacity. This design assumes a uniform basin geometry – a trapezoidal volume with a flat rectangular bottom surface. Note that basins can have many design constraints, such as available space, topography and proximity to receiving stream, that influence the final basin shape, location and geometrical configuration. Each design must be compatible with the site layout and must clearly address the design constraints. Detailed grading plans are required to ensure that the basin design can be constructed as intended on the site, given the site topography and space limitations.

This design follows the steps outlined in Chapter 7, Section 7.31. (The initial basin planning step should include consideration of determining the best location and general layout for the basin. The following steps provide a general approach toward developing the basin hydraulic design for storage and spillways.

### **GIVEN:**

Design a sediment basin for an outfall to an *impaired* stream for the following assumptions and conditions:

1. Total drainage area = 10 acres
2. Time of concentration,  $T_c = 7.4$  min (TR-55 analysis)
3. Construction site SCS Curve Number,  $CN = 91$  (TR-55 analysis)
4. Incoming 5-year, 24-hour peak flow,  $Q_p = 47$  cfs (TR-55 generated non-routed inflow to the sediment basin)
5. Incoming 25-year, 24-hour peak flow,  $Q_p = 47$  cfs (TR-55 generated non-routed inflow to the sediment basin)
6. Assume that stormwater runoff enters the basin at the upper forebay end
7. Assume a minimum 4L:1W rectangular pond having 2H:1V interior side slopes where the incremental volume of basin depth is calculated from  $V = \frac{(A_t + A_b)d}{2}$  where
  - $V =$  Volume of basin ( $\text{ft}^3$ )
  - $A_t =$  Basin top surface area ( $\text{ft}^2$ )
  - $A_b =$  Basin bottom surface ( $\text{ft}^2$ )
  - $d =$  incremental or total depth (ft)
8. Assume a permanent pool depth of 2 ft
9. Wet storage (permanent pool) basis = 67 CY/acre (1,809  $\text{ft}^3$ /acre)
10. Total Dry Storage basis (Basin + Forebay) = 67 CY/acre (1,809  $\text{ft}^3$ /acre)
11. Forebay storage = 25% x 67 CY/acre = 16.8 CY/acre (452  $\text{ft}^3$ /acre)

### **REQUIRED DESIGN ELEMENTS:**

- Wet, dry & forebay storage volumes
- Permanent pool - principal spillway riser crest elevation
- Riser pipe size
- Principal spillway conduit (barrel) pipe size
- Floating skimmer design: overall size selection and orifice diameter
- Emergency Spillway design: trapezoidal X-section, control crest elevation, width and side slopes
- Embankment dam crest elevation
- Bottom of pond elevation

**SOLUTION:****Step 1: Set the basin geometry.**

- Set the basin length to width ratio at 4L:1W
- Determine the storage volume needed (Total = sum of the wet, dry, and forebay storage volumes below riser crest)

$$\text{Total storage volume} = (134 \text{ CY/ac}) \times (10 \text{ ac}) = 1,340 \text{ CY} = 36,180 \text{ ft}^3$$

$$\text{Wet storage required at permanent pool} = (67 \text{ CY/ac}) \times (10 \text{ ac}) = 670 \text{ CY} = 18,090 \text{ ft}^3$$

$$\text{Total dry storage, including forebay vol. required} = (67 \text{ CY/ac}) \times (10 \text{ ac}) = 670 \text{ CY} = 18,090 \text{ ft}^3$$

$$\text{- Dry storage in forebay} = (16.8 \text{ CY/ac}) \times (10 \text{ ac}) = 168 \text{ CY} = 4,536 \text{ ft}^3$$

$$\text{- Dry storage in main basin} = 18,090 \text{ ft}^3 - 4,536 \text{ ft}^3 = 13,554 \text{ ft}^3$$

- Determine the required minimum surface area at the riser elevation,  $A_s$

$$A_s = 0.01Q_p = (0.01) \times (47 \text{ cfs}) = 0.47 \text{ ac} = 20,473.2 \text{ ft}^2$$

Determine a basin shape that provides the 4L: 1W surface geometry.

- Try 72 ft x 288 ft

$$\text{- } A_s = 72\text{ft} \times 288 \text{ ft} = 20,736 \text{ ft}^2 \geq 20,473.2 \text{ ft}^2 \leftarrow \text{Therefore OK}$$

- The required surface area needs to be split between the basin and the forebay. The widths will be the same but the sum of the lengths should be equal to the total length of 288 ft. (Note: the thickness of the forebay berm, normally around 4 or 5 ft, is not included here in determining wet and dry storage, but would need to be added to the overall basin length and shown in the plans):

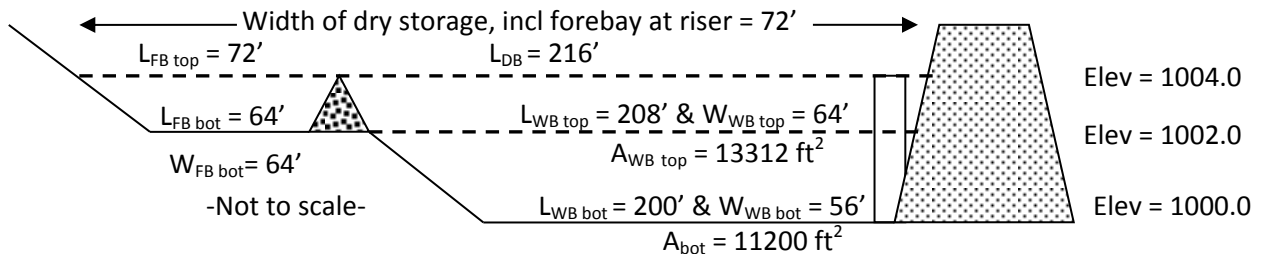

Note: In order to determine the Wet Storage Volume (from bottom to the given permanent pool depth of 2') an intermediate surface elevation at the permanent pool needs to be calculated. For this example the surface area at the permanent pool is 157' x 64'.

**Step 2: Establish basin elevations.**

Determine the riser height that corresponds to the required storage volumes. From the storage volume, determine storage volumes at specific elevations:

$$V = \frac{(A_t + A_b)d}{2}$$

- Assume a trial riser height of 4 ft (elev. 1004.0 ft)

- Set the elevation of the bottom of pond = 1000.0 ft and Permanent Pool Elev. = 1002.0

- Pond Dimensions at bottom of pond (elev 1000.0) = 149' x 56' = 8344 ft<sup>2</sup> for 2:1 SS

- Pond Dimensions at permanent pool (elev. 1002.0) = 157' x 64' = 10,048 ft<sup>2</sup> for 2:1 SS

- **Wet Storage (From bottom to permanent pool) =  $24,512 \text{ ft}^3 \geq 18,090 \text{ ft}^3$  therefore OK**

- Forebay Dimensions at bottom (elev. 1002.0) =  $64' \times 64' = 4096 \text{ ft}^2$  for 2:1 SS

- Forebay dimensions at top (elev. 1004.0) =  $72' \times 72' = 5184 \text{ ft}^2$  for 2:1 SS

- **Forebay Storage =  $9,280 \text{ ft}^3 \geq 4,536 \text{ ft}^3$  therefore OK**

- Main dry pond dimensions at perm pool (elev 1002.0) =  $157' \times 64' = 10,048 \text{ ft}^2$  for 2:1 SS

- Main dry pond dimensions at top (elev 1004.0) =  $216' \times 72' = 15,552 \text{ ft}^2$  for 2:1 SS

- **Dry Storage (from Elevation 1002' to elev. 1004') =  $28,864 \text{ ft}^3 \geq 13,554 \text{ ft}^3$  therefore OK**

- **Total Dry Storage, including Forebay =  $9,280 \text{ ft}^3$  (24%) +  $28,864 \text{ ft}^3$  (76%) =  $38,144 \text{ ft}^3 \geq 18,090 \text{ ft}^3$  therefore OK**

Therefore the trial riser height of 4 ft is acceptable

Set the bottom of basin elevation = 1000.0 ft

Set the permanent pool elevation = 1002.0 ft

Set the riser crest elevation = 1004.0 ft

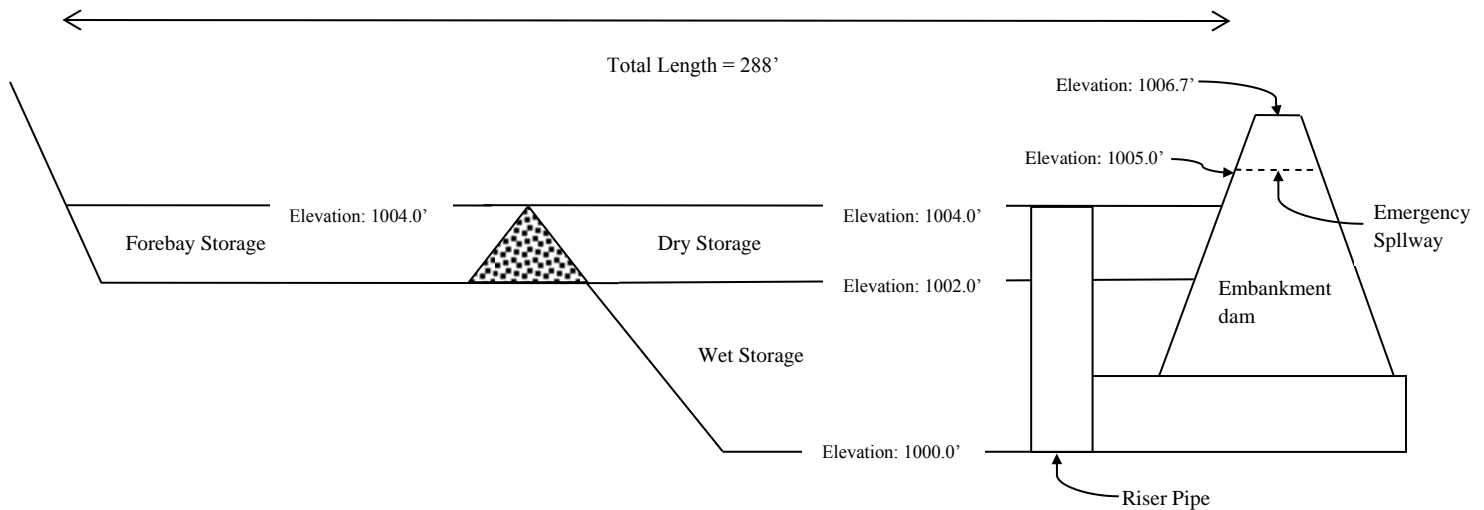

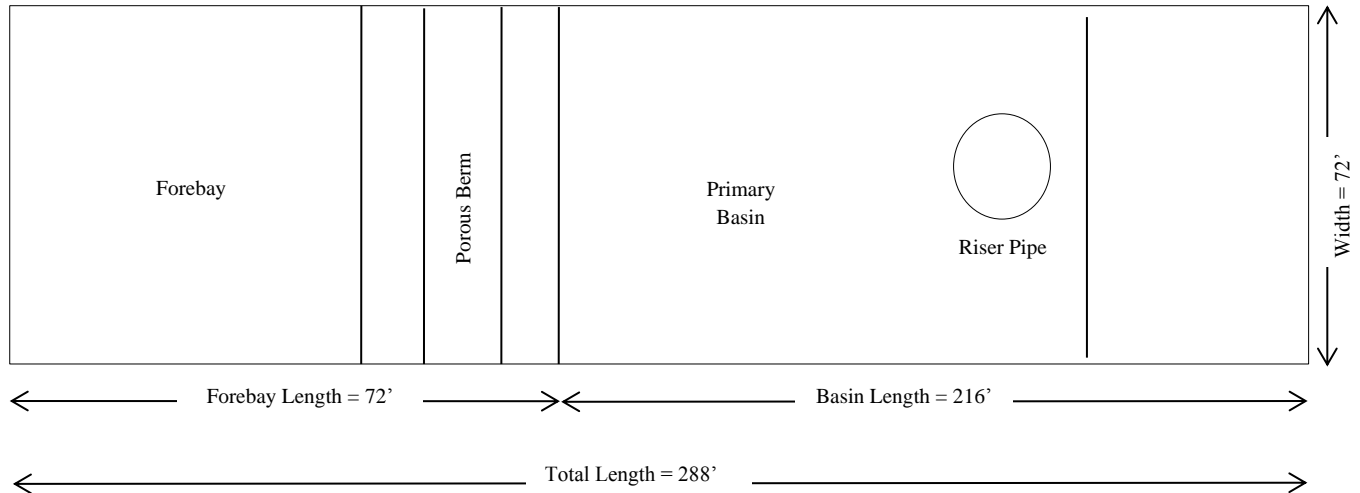

### Step 3: Design spillways

#### Principal Spillway

(A) Establish principal spillway elevation = 1004.0 ft

- Assume riser diameter = 36" = 3 ft

Circumference = 113" = 9.42' of weir length

- Assume rectangular sharp crested weir w/ a coefficient of 3.33

(Note: The riser operates as a sharp-crested weir up to a certain head and then switches to orifice flow.)

- Hydraflow Express gives a depth of 1.31' for 47 cfs. At the minimum freeboard of 1' from top of principal spillway to emergency spillway, the emergency spillway will convey a portion of the 5-year, 24-hour design storm.
- *Conduit Pipe Size (The capacity of the service spillway is usually limited by the outlet pipe.)*  
From Hydraflow Hydrographs an outlet pipe size = 24" = 2' has adequate capacity.

#### Emergency Spillway (Flow credit is given to the service spillway but not the dewatering device.)

(B) Emergency spillway elevation = 1004.0' (Principal Elevation) + 1' (minimum freeboard) = 1005.0 ft

- 25-year, 24-hour storm event:  $Q_p = 67$  cfs
- Emergency spillway design flow = 67 cfs - 31.37 cfs (flow credited to 3-ft diameter principal spillway at 1-ft head over crest) = 35.63 cfs
- Assume a weir length = 20'
- Hydraflow Express gives a flow control depth of 0.66 ft
- Top of Berm Elevation = 1005.0' (Emergency Spillway Elevation) + 0.66' (depth of 25 yr storm) + 1' (minimum freeboard) = 1006.7 ft
- Emergency Spillway Sideslopes = 4:1



**Step 4: Dewatering Device (Skimmer)**

Need to dewater the dry storage (38,144 ft<sup>3</sup>) in 72 hours

- Choose a 4-inch skimmer which has a capacity of 60,327 cubic feet in 3 days.
- Determine the orifice size for the manufacturer's given orifice head and discharge coefficient. The head will vary depending upon the manufacturer's design depth of submergence for a given orifice diameter. Use the following Skimmer size vs. orifice head table based on the Faircloth® skimmer as an example.

Skimmer Size (inches)	Head (h) on orifice in ft
1.5	0.125
2	0.167
2.5	0.208
3	0.25
4	0.333
5	0.333
6	0.417
8	0.5

\*The flow (cfs) through an orifice can be computed as:

$$Q = CA_o\sqrt{2gH} = C \pi r_o^2 \sqrt{2gH}$$

where C is the orifice coefficient (assumed to be 0.59), A<sub>o</sub> is the orifice cross-sectional area in ft<sup>2</sup>, r<sub>o</sub> is the orifice opening radius (ft), g is the acceleration of gravity (32.2 ft/sec<sup>2</sup>), and H is the driving head on the orifice center in feet.

Rearranging the previous equation, the desired orifice radius in feet can now be calculated using the following equation:

$$r_o = \sqrt{\frac{Q}{14.87 * \sqrt{H}}}$$

Where flow, Q, is based on draining the total dry volume in 3 days as follows:

$$Q_d = \frac{V}{t_d} = \frac{38,144 \text{ ft}^3}{3 \text{ days}} = 12,715 \frac{\text{ft}^3}{\text{day}} = 0.147 \text{ cfs}$$

Try a 4-inch skimmer, which has a flow capacity rating for draining up to 60,327 cubic feet in 3 days and has an orifice head, h = 0.333 ft

$$r_o = \sqrt{0.147 \frac{\text{ft}^3}{\text{sec}} / (14.87 * \sqrt{0.333 \text{ ft}})} = 0.131 \text{ ft} = 1.6 \text{ inches}$$

Therefore, use a 4- inch skimmer with an orifice diameter d<sub>o</sub> of 3.2 inches

\*Note: Skimmer manufacturer charts or software may be used as an alternative method for sizing orifice.

In Summary:

EXAMPLE BASIN 1	RISER PIPE DIA. (FT)	BARREL PIPE DIA. (FT)	PERMANENT POOL ELEVATION (FEET, AMSL)	PRINCIPAL SPILLWAY ELEVATION (FEET, AMSL)	EMERGENCY SPILLWAY ELEVATION (FEET, AMSL)
	3	2	1002.0	1004.0	1005.0
	EMERGENCY SPILLWAY WIDTH (FT)	EMERGENCY SPILLWAY SIDESLOPE	TOP OF EMBANKMENT ELEVATION (FEET, AMSL)	BOTTOM OF BASIN ELEVATION (FEET, AMSL)	SKIMMER (ORIFICE) SIZE (INCHES)
	20	4:1	1006.7	1000.0	4 (3.2)

Option: The above parameters can be entered into hydraulic routing software to refine the design. This would likely result in more credit being given to the principal spillway for a portion of the 25-year, 24-hour storm flow and the overall depth and volume of the basin may be able to be reduced. Following the design presented above will result in a conservative design (i.e. storage > 134 CY/acre). A minimum 25% of the dry storage volume will be provided as part of the forebay at the pond inlet. In other words, this volume can be credited to the overall dry storage (such that 75% of the required total dry storage volume is provided in the primary basin).

Note: This sediment basin design example does not include required emergency spillway lining calculations and design nor does it include service spillway outlet structure apron design and calculations. Furthermore, the sediment basin design example does not discuss required service spillway anti-buoyancy pad, anti-vortex & trashrack, dam design analysis, anti-seep collars, details of surface skimmer connection to riser & skimmer base pad, or forebay berm design.