



MULTIMODAL PROJECT SCOPING MANUAL

**Design Division
Multimodal Division**

April 2018

[This page intentionally left blank]

Preface

The purpose of the Tennessee Department of Transportation *Multimodal Project Scoping Manual* is to provide designers, planners, and decision-makers with guidance for incorporating multimodal elements into transportation projects. The intended audience are those involved with state or federally funded projects in Tennessee. However, the guidance is applicable to any transportation project, regardless of location or funding source.

This manual is separated into 13 sections:

- Section 1.0 *Overview of Policies and Legislation* provides the legal framework for multimodal design.
- Section 2.0 *Multimodal Design Background* provides important information concerning multimodal concepts and the design flexibility that is often required to implement them. When, where, and what type of multimodal elements should be provided for various contexts is also discussed.
- Section 3.0 *Safety* provides a brief discussion of safety concepts, including the need to account for the safety of all street users, and not just motorists.
- Section 4.0 *Roadway Design Elements* focuses on roadway design elements that enhance a street's design for all users.
- Section 5.0 *Road Diets* provides guidance for the reconfiguration of one or more travel lanes to provide space for bicycle lanes, turn lanes, streetscapes, wider sidewalks, and other purposes.
- Section 6.0 *Bicycle Facilities* provides guidance for designing facilities for bicycle use.
- Section 7.0 *Pedestrian Facilities* provides guidance for designing pedestrian facilities.
- Section 8.0 *Transit Accommodations* provides guidance for incorporating transit elements onto streets.
- Sections 9.0 through 13.0 cover other topics related to multimodal design, such as signal timing, implementing multimodal elements into resurfacing projects, implementing multimodal elements at interchanges, other utilizations of public right-of-way, and multi-modal scale barriers.

The *Multimodal Project Scoping Manual* was developed with guidance found in recent documents from the Federal Highway Administration, the American Association of State Highway and Transportation Officials, the National Association of City Transportation Officials, the Institute of Transportation Engineers, the National Cooperative Highway Research Program, other state departments of transportation, and other sources. The sources are listed following each section in which they are referenced. Many of the sources are available for free download if additional information is needed.

[This page intentionally left blank]

Table of Contents

1.0	Overview of Policies and Legislation	1-1
1.1	FAST Act Design Flexibility and Multimodal Guidance	1-1
1.2	TDOT’s Multimodal Access Policy	1-4
1.3	USDOT Policy Statement on Bicycle and Pedestrian Accommodation.....	1-8
1.4	FHWA Design Flexibility Guidance	1-8
1.5	FHWA Bicycle and Pedestrian Facility Design Flexibility.....	1-10
1.6	FHWA Strategic Agenda for Pedestrian and Bicycle Transportation	1-10
1.7	TDOT Accessibility Guidance	1-11
1.8	Section 1.0 Sources.....	1-13
2.0	Multimodal Design Background	2-1
2.1	Land Use Context	2-1
2.2	Design Flexibility	2-2
2.3	Design Flexibility and Risk	2-3
2.4	Balancing Level, Quality, and Safety of Service	2-4
2.5	Motor Vehicle, Bicyclists, and Pedestrian Accommodations.....	2-5
2.5.1	Separate Accommodation for All Users.....	2-5
2.5.2	Partial Sharing for Bicycles and Motor Vehicles	2-6
2.5.3	Shared Bicycle/Motor Vehicle Accommodation	2-7
2.5.4	Shared Bicycle/Pedestrian Accommodation.....	2-8
2.5.5	Shared Accommodation for All Users	2-9
2.6	Multimodal Functional Classification System Matrix	2-10
2.7	Multimodal Street Examples	2-11
2.8	When to Construct Separate Multimodal Accommodations.....	2-15
2.8.1	Pedestrian Accommodations	2-16
2.8.2	Bicyclists Accommodations.....	2-17
2.8.3	Transit User Accommodations	2-17
2.8.4	Exclusions for Pedestrian and Bicyclist Accommodations.....	2-18
2.9	Section 2.0 Sources.....	2-19
3.0	Safety.....	3-1
3.1	HSM Limitations for Multimodal Safety Analysis	3-1
3.2	Safety vs. Speed.....	3-1
3.3	Lane Width Effect on Safety.....	3-4
3.3.1	Low-Speed Streets	3-4
3.3.2	High-Speed Roadways	3-4
3.4	Shoulder Width Effect on Safety	3-7
3.4.1	Low-Speed Streets	3-7
3.4.2	High-Speed Roadways	3-7
3.5	Pedestrian Path Effects on Safety.....	3-8
3.6	Section 3.0 Sources.....	3-8
4.0	Roadway Design Elements.....	4-1
4.1	Design Vehicles vs. Control Vehicles	4-1
4.2	Curb Radii.....	4-2
4.3	Speed	4-5
4.3.1	Operating, Posted, and Running Speed.....	4-5
4.3.2	Design Speed	4-6
4.3.3	Target Speed.....	4-6
4.3.4	Engineering Speed Management Countermeasures.....	4-6
4.3.5	Transition Zones	4-8

4.4	Travel Lanes	4-15
4.5	Shoulders	4-16
4.6	Curb Lane Plus Shoulder Width	4-19
4.7	Turn Lanes	4-19
4.7.1	Left-Turn Lanes	4-19
4.7.2	Right-Turn Lanes (& Channelized Islands).....	4-19
4.8	Medians	4-20
4.9	On-Street Parking	4-23
4.10	Urban Freight and Deliveries	4-26
4.11	Roundabouts	4-27
4.12	Roadway Design Elements Summary	4-29
4.13	Section 4.0 Sources.....	4-30
5.0	Road Diets	5-1
5.1	Benefits of a Road Diet	5-2
5.2	Road Diet Traffic Criteria.....	5-2
5.3	Section 5.0 Sources.....	5-3
6.0	Bicycle Facilities	6-1
6.1	Shared Lanes (Sharrows)	6-3
6.2	Bicycle Lanes.....	6-3
6.2.1	Bicycle Lane Design Criteria	6-3
6.2.2	Buffered Bicycle Lanes	6-4
6.2.3	Considerations at Intersections.....	6-7
6.2.4	Signing and Pavement Markings (Mainline and Intersections)	6-7
6.3	Separated Bicycle Lanes/Cycle Tracks	6-15
6.4	Shared-Use Paths.....	6-17
6.5	Bicycle Signals.....	6-17
6.6	Section 6.0 Sources.....	6-18
7.0	Pedestrian Facilities	7-1
7.1	Curb Ramps, Cross Walk Markings, and Detectable Warning Surfaces.....	7-1
7.2	Sidewalk Design without Curb	7-5
7.3	Sidewalk Design with Curb	7-6
7.3.1	Edge Zone	7-8
7.3.2	Furnishing Zone.....	7-8
	Pedestrian Buffer.....	7-8
	Planting Strip/Landscaping.....	7-8
	Street Furniture & Mailboxes	7-8
	Driveway Slope Benefit	7-9
	Place to locate Utilities	7-9
	Furnishing Zone Summary	7-9
7.3.3	Throughway Zone.....	7-10
	Width.....	7-10
	Cross slope	7-10
	Grade	7-11
7.3.4	Frontage Zone	7-11
7.4	Crosswalks at Intersections	7-11
7.4.1	Curb Extensions/Bulb-Outs.....	7-12
7.4.2	Median Refuge Islands at Intersections	7-13
7.4.3	Pedestrian Considerations at Roundabouts	7-13
7.5	Crosswalks at Midblock Locations	7-13
7.5.1	Pavement Markings and Static Signing.....	7-16

7.5.2	HAWK PHB Pedestrian Crossing Beacon.....	7-16
7.5.3	Median Refuge Islands at Midblock Locations	7-18
7.5.4	Curb Extensions/ Bulb-Outs.....	7-19
7.5.5	Raised Crosswalks	7-20
7.6	Shared-Use Paths.....	7-21
7.7	Section 7.0 Sources.....	7-26
8.0	Transit Accommodations	8-1
8.1	Transit Stops.....	8-1
8.1.1	Curbside	8-1
8.1.2	Curb Extensions/ Bus Bulbs.....	8-3
8.1.3	Bus Turnouts	8-4
8.2	Transit Stop Placement.....	8-5
8.2.1	At Intersections	8-5
8.2.2	At Midblock Locations	8-6
8.3	Section 8.0 Sources.....	8-7
9.0	Signal Timing Considerations	9-1
9.1	Section 9.0 Sources.....	9-3
10.0	Multimodal Accommodations in Resurfacing Projects.....	10-1
10.1	Section 10.0 Sources.....	10-1
11.0	Implementing Multimodal Elements at Interchanges.....	11-1
11.1	Section 11.0 Sources.....	11-3
12.0	Other Utilizations of Public Right-of-Way.....	12-1
12.1	Utilities	12-1
12.2	Landscaping and Green Infrastructure.....	12-1
12.3	Section 12.0 Sources.....	12-2
13.0	Multimodal-Scale Barriers	13-1

Table of Exhibits

Exhibit 1-1:	FAST Act Design Standards Memorandum	1-3
Exhibit 1-2:	TDOT Multimodal Policy (1 of 4).....	1-5
Exhibit 1-3:	TDOT Multimodal Policy (2 of 4).....	1-6
Exhibit 1-4:	TDOT Multimodal Policy (3 of 4).....	1-7
Exhibit 1-5:	TDOT Multimodal Policy (4 of 4).....	1-8
Exhibit 1-6:	Controlling Criteria requiring FHWA Design Exception	1-9
Exhibit 1-7:	TDOT PROWAG Adoption	1-12
Exhibit 2-1:	Land Use Contexts.....	2-2
Exhibit 2-2:	Separate Accommodation for All Users.....	2-5
Exhibit 2-3:	Partial Sharing for Bicycles and Motor Vehicles.....	2-6
Exhibit 2-4:	Shared Bicycle/Motor Vehicle Accommodation.....	2-7
Exhibit 2-5:	Shared Bicycle/Pedestrian Accommodation	2-8
Exhibit 2-6:	Shared Accommodation for All Users	2-9
Exhibit 2-7:	Functional Classification System Matrix.....	2-10
Exhibit 2-8:	Suburban Low traffic, low-speed, mode-shared residential street.....	2-11
Exhibit 2-9:	Rural Highway with Paved Shoulder.....	2-12
Exhibit 2-10:	Rural Road with Separated Shared-Use Path.....	2-12
Exhibit 2-11:	Low-Density Suburban Street.....	2-13
Exhibit 2-12:	High-Density Suburban Street	2-13
Exhibit 2-13:	Urban Town Main Street.....	2-14
Exhibit 2-14:	Urban Main Street	2-14

Exhibit 2-15: Urban Core Street	2-15
Exhibit 3-1: Pedestrian Safety vs. Vehicle Speed	3-2
Exhibit 3-2: Driver’s Cone of Vision	3-3
Exhibit 3-3: CMF for Lane Width on High-Speed Two-Lane Roadway Segments.....	3-5
Exhibit 3-4: CMF for Lane Width on High-Speed Multilane Undivided Roadway Segments....	3-6
Exhibit 3-5: CMF for Lane Width on High-Speed Multilane Divided Roadway Segments	3-6
Exhibit 3-6: CMF for Shoulder Width on High-Speed Two-Lane Roadway Segments	3-7
Exhibit 3-7: CMF for Shoulder Width on High-Speed Multilane-Divided Highways	3-7
Exhibit 4-1: Design Vehicle vs. Control Vehicle Turning Movement Path	4-2
Exhibit 4-2: Turning Radius vs. Curb Radius.....	4-3
Exhibit 4-3: Preferred Channelized Island Design	4-5
Exhibit 4-4: Speed Reduction Features	4-7
Exhibit 4-5: Transition Zone Areas	4-9
Exhibit 4-6: Speed Reduction Treatment; Center Island/Raised Median	4-10
Exhibit 4-7: Speed Reduction Treatment; Roundabout.....	4-11
Exhibit 4-8: Speed Reduction Treatment; Roadway Narrowing	4-12
Exhibit 4-9: Speed Reduction Treatment; Road Diet	4-12
Exhibit 4-10: Speed Reduction Treatment; Transverse Pavement Markings	4-13
Exhibit 4-11: Speed Reduction Treatment; Rumble Strips.....	4-13
Exhibit 4-12: Speed Reduction Treatment; Colored Pavement.....	4-14
Exhibit 4-13: Speed Reduction Treatment; Welcome Sign	4-14
Exhibit 4-14: Range of Travel Lane Widths	4-16
Exhibit 4-15: Minimum Shoulder Width (in feet) to Provide Various Functions	4-17
Exhibit 4-16: Recommended Paved Widths of Shoulders (Feet)	4-18
Exhibit 4-17: ITE Recommended Median Widths	4-21
Exhibit 4-18: Median Refuge Island Minimum Recommended Dimensions	4-22
Exhibit 4-19: Median Nose on Cut-Through Median.....	4-22
Exhibit 4-20: Parallel Parking Design	4-24
Exhibit 4-21: Traditional Angle Parking	4-25
Exhibit 4-22: Back-In Angle Parking	4-25
Exhibit 4-23: Suburban Multimodal Roundabout	4-27
Exhibit 4-24: Roundabout Applicability Guidance	4-28
Exhibit 4-25: Lane and Paved Shoulder Width Summary	4-29
Exhibit 5-1: Example Road Diet	5-1
Exhibit 5-2: Example Road Diet	5-2
Exhibit 6-1: Bicycle Facility Levels of Separation.....	6-2
Exhibit 6-2: Bicycle Lane Dimensions	6-4
Exhibit 6-3: Buffered Bicycle Lane (Between Both the Motor Vehicle and Parking Lanes)	6-5
Exhibit 6-4: Buffered Bicycle Lane (Between Motor Vehicle and Bicycle Lanes)	6-6
Exhibit 6-5: Buffered Bicycle Lane (Between Parking and Bicycle Lanes)	6-6
Exhibit 6-6: Bicycle Lane Treatment at a Right Turn Only Lane	6-8
Exhibit 6-7: Bicycle Lane Treatment at Parking Lane into a Right Turn Only Lane	6-8
Exhibit 6-8: Pavement Markings for Bicycle Lanes on a Two-Way Street.....	6-9
Exhibit 6-9: Green Pavement Markings	6-11
Exhibit 6-10: Bicycle Box (with Green Pavement Markings)	6-13
Exhibit 6-11: Bicycle Box Layout	6-14
Exhibit 6-12: Cycle Track (Retrofit with Delineators)	6-15
Exhibit 6-13: Cycle Track with Curb/Median Physical Separation.....	6-16
Exhibit 6-14: One-Way Cycle Track with On-Street Parking	6-16
Exhibit 7-1: Perpendicular Curb Ramp	7-2

Exhibit 7-2: Parallel Curb Ramp 7-2
Exhibit 7-3: Blended Transition 7-3
Exhibit 7-4: Longitudinal and Transverse Crosswalks 7-3
Exhibit 7-5: TDOT-Compliant Detectable Warning Surfaces 7-5
Exhibit 7-6: Sidewalk without Curb 7-6
Exhibit 7-7: Public Right-of-Way Zones - Table 7-7
Exhibit 7-8: Public Right-of-Way Zones - Image 7-7
Exhibit 7-9: Driveway Relationship to Furnishing Zone..... 7-9
Exhibit 7-10: Minimum Furnishing Zone Width Summary 7-9
Exhibit 7-11: Poor Crosswalk Example 7-12
Exhibit 7-12: Recommendations for Installing Midblock Crosswalks..... 7-15
Exhibit 7-13: HAWK Pedestrian Hybrid Beacon 7-16
Exhibit 7-14: Guidelines for the Installation of HAWK Beacons on Low-Speed Roadways ... 7-17
Exhibit 7-15: Guidelines for the Installation of HAWK Beacons on High-Speed Roadways .. 7-17
Exhibit 7-16: Angled Midblock Crossing 7-19
Exhibit 7-17: Raised Crosswalk (with Refuge Island) 7-20
Exhibit 7-18: Shared-Use Path Typical Cross Section..... 7-21
Exhibit 7-19: Shared-Use Path Parallel to Street with Pavement Markings 7-23
Exhibit 7-20: TDOT Shared-Use Path Guidance 7-24
Exhibit 8-1: PROWAG Transit Boarding and Alighting Area Requirements 8-2
Exhibit 8-2: Minimum Dimensions for Curbside Transit Facilities..... 8-3
Exhibit 8-3: Bus Turnout..... 8-4
Exhibit 8-4: Advantages and Disadvantages of Far and Near side Bus Stops 8-6
Exhibit 8-5: Advantages and Disadvantages of Midblock Bus Stops 8-7
Exhibit 9-1: Signal Timing Strategies, Settings, and Policy Examples 9-2
Exhibit 11-1: Pedestrian and Bicyclist Accessible Interchange Configurations 11-2
Exhibit 11-2: Pedestrian and Bicyclist Challenging Interchange Configurations..... 11-2
Exhibit 12-1: 28th/31st Avenue Connector in Nashville with Landscaping and Bioswales 12-2

[This page intentionally left blank]

Acronyms

AASHTO	American Association of State Highway and Transportation Officials
ADA	Americans with Disabilities Act
ADT	Average Daily Traffic
APS	Accessible Pedestrian Signal
DHV	Design Hourly Volume
FAST Act	Fixing America's Surface Transportation Act
FCS	Functional Classification System
FHWA	Federal Highway Administration
HAWK	High-Intensity Activated Crosswalk
HSM	Highway Safety Manual
ITE	Institute of Transportation Engineers
LOS	Level of Service
MPH	Miles per Hour
MPO	Metropolitan Planning Organization
MUTCD	Manual on Uniform Traffic Control Devices
NACTO	National Association of City Transportation Officials
NCHRP	National Cooperative Highway Research Program
NHS	National Highway System
PHB	Pedestrian Hybrid Beacon
PROWAG	Public Right-of-Way Accessibility Guidelines
TDOT	Tennessee Department of Transportation
USDOT	United States Department of Transportation
VPD	Vehicles per Day
VPH	Vehicles per Hour
VPHPL	Vehicles per Hour per Lane
3R	Resurfacing, Restoration, Rehabilitation

[This page intentionally left blank]

1.0 OVERVIEW OF POLICIES AND LEGISLATION

The purpose of the Tennessee Department of Transportation (TDOT) *Multimodal Project Scoping Manual* is to provide designers, planners, and decision-makers with guidance for incorporating multimodal elements into transportation projects. The intended audience are those involved with state or federally funded projects in Tennessee.

Transportation has a considerable influence on the quality of life in communities. On TDOT projects, early coordination with local governments in the early phases of project development is needed to ensure a project's success. Excellent transportation is critical for the public's mobility, safety, economy, and health. The Tennessee Department of Transportation (TDOT) considers several factors in maintaining and improving its transportation system, including:

- Safety of all users
- The need for access and mobility
- Accessibility for people with disabilities
- Compatibility and support between the transportation network and the adjacent land uses served
- Cost effectiveness

Several state and federal policies and guidance are the foundation for the TDOT *Multimodal Project Scoping Manual*. They include:

- FAST Act Design Flexibility and Multimodal Guidance (see Section 1.1)
- TDOT's Multimodal Access Policy (see Section 1.2)
- USDOT Policy Statement on Bicycle and Pedestrian Accommodation (see Section 1.3)
- FHWA Design Flexibility Guidance (see Section 1.4)
- FHWA Bicycle and Pedestrian Facility Design Flexibility (see Section 1.5)
- FHWA Strategic Agenda for Pedestrian and Bicycle Transportation (see Section 1.6)
- TDOT Accessibility Guidance (see Section 1.7)

1.1 FAST ACT DESIGN FLEXIBILITY AND MULTIMODAL GUIDANCE

The Fixing America's Surface Transportation Act (FAST Act) is the current federal funding and authorization bill governing United States federal surface transportation spending. It was signed into law on December 4, 2015. The FAST Act authorizes \$305 billion over fiscal years 2016 through 2020 for highway, highway and motor vehicle safety, public transportation, motor carrier safety, hazardous materials safety, rail, and research, technology, and statistics programs.

The FAST Act makes several changes to design standards to increase flexibility and provide for greater accommodation of all highway users and their safety. It requires the United States Department of Transportation to encourage states and Metropolitan Planning Organizations (MPOs) to adopt design standards for federal surface transportation projects that provide for adequate accommodation of all users of the surface transportation network, including motorized and non-motorized users in all stages of project planning, development, and operation.

The FAST Act lists two resources that must be considered in developing design criteria. These new resources are:

- American Association of State Highway and Transportation Officials (AASHTO) *Highway Safety Manual*
- National Association of City Transportation Officials (NACTO) *Urban Street Design Guide*

The *Highway Safety Manual* (HSM) contains concepts, guidelines, and computational procedures for predicting the safety performance of various highway facilities. This allows the inclusion of predictive safety analysis as a determinant in the alternatives analysis. The *Urban Street Design Guide* promotes the concept of streets as spaces for people as well as arteries for traffic. It typically places more emphasis on non-motorized transportation than traditional design resources from AASHTO.

TDOT publishes its roadway design standards and guidelines online at: <https://www.tn.gov/tdot/roadway-design/design-standards.html>. These standards are based on many sources, but lean heavily on AASHTO's *A Policy on Geometric Design of Highways and Streets*. Under the FAST Act, a locality may use a different roadway design publication than the state (with state approval), if the roadway is owned by the locality, the roadway is not on the Interstate System, the locality is the direct recipient of federal funds for the project, the publication is recognized by the Federal Highway Administration (FHWA) and adopted by the locality, and the design complies with all other applicable federal laws. To date, no locality in Tennessee has petitioned TDOT for the ability to use different standards, nor has TDOT developed an allowance process. FHWA's FAST Act *Design Standards Memorandum* is provided in Exhibit 1-1.

EXHIBIT 1-1: FAST ACT DESIGN STANDARDS MEMORANDUM



U.S. Department of Transportation
Federal Highway Administration

DESIGN STANDARDS

Purpose

The FAST Act makes several changes to design standards to increase flexibility and provide for greater accommodation of all highway users.

Statutory citations: FAST Act §§ 1404 and 1442; 23 U.S.C. 109

Program Features

Except as specified below, the FAST Act continues all of the design standards and requirements that were in effect under MAP-21.

Design considerations on the National Highway System (NHS)

The FAST Act now requires that designs *shall consider* (previously “may take into account”):

- The constructed and natural environment of the area;
- The environmental, scenic, aesthetic, historic, community, and preservation impacts of the activity;
- Access for other modes of transportation; and
- Cost savings by utilizing flexibility that exists in current design guidance and regulations.

The FAST Act added the last criterion to this list of considerations. [FAST Act § 1404; 23 U.S.C. 109(c)(1)]

Development of criteria for the NHS

The FAST Act adds two new resources that DOT must consider in developing criteria to implement the requirements stated above. These new resources for consideration are:

- American Association of State Highway and Transportation Officials (AASHTO) Highway Safety Manual; and
- National Association of City Transportation Officials (NACTO) Urban Street Design Guide.

[FAST Act § 1404; 23 U.S.C. 109(c)(2)]

Design standard flexibility for localities

Under the FAST Act, a locality may use a different roadway design publication than the State (with State approval), if the roadway is owned by the locality, the roadway is not on the Interstate System, the locality is the direct recipient of Federal funds for the project, the publication is recognized by FHWA and adopted by the locality, and the design complies with all other applicable Federal laws. [FAST Act § 1404(b)]

Accommodation of non-motorized users

The FAST Act requires DOT to encourage States and MPOs to adopt design standards for Federal surface transportation projects that provide for the safe and adequate accommodation (as determined by the State) of all users of the surface transportation network, including motorized *and* non-motorized users in all stages of project planning, development, and operation. Additionally, no later than 2 years after the enactment of the FAST Act, DOT must release a report identifying examples of State laws and policies in this area and examples of best practices. [FAST Act § 1442]

1.2 TDOT'S MULTIMODAL ACCESS POLICY



On July 31, 2015, TDOT issued its updated *Multimodal Access Policy*. The purpose was to create and implement a multimodal transportation policy that encourages access and mobility for users of all ages and abilities through the planning, design, construction, maintenance, and operation of new construction, reconstruction and retrofit transportation facilities that are federally or state funded. Users include, but are not limited to, motorists, transit riders, freight-carriers, bicyclists, and pedestrians.

The policy notes certain conditions where it is generally inappropriate to provide multimodal facilities. Those conditions are summarized as follows:

- On controlled access facilities
- Where the cost of accommodations is excessively disproportionate to the need and probable use. Excessively disproportionate is defined as exceeding 20 percent of the cost of the project. However, compliance with the Americans with Disabilities Act (ADA) requirements is not an exception
- Areas in which the population and employment densities or level of transit service does not justify the incorporation of multimodal alternatives
- Where TDOT is unable to negotiate and enter into an agreement with a local government to assume the operational and maintenance responsibility of the facility

Exceptions for not accommodating multimodal transportation users on state roadway projects in accordance with the policy shall be documented describing the basis and supporting data for the exception, and must be approved by TDOT's Chief Engineer and Chief of Environment or their designees. TDOT's *Multimodal Access Policy* is provided in Exhibit 1-2 through Exhibit 1-5.

EXHIBIT 1-2: TDOT MULTIMODAL POLICY (1 OF 4)

 <p>DEPARTMENTAL POLICY State of Tennessee Department of Transportation</p>	<p>Policy Number: 530-01</p>
	<p>Effective Date: July 31, 2015</p>
<p>Approved By:</p> 	<p>Supersedes: December 1, 2010</p>
<p>SUBJECT: Multimodal Access Policy</p>	

- I. RESPONSIBLE OFFICE: Multimodal Transportation Resources Division
- II. AUTHORITY: T.C.A. 4-3-2303. If any portion of this policy conflicts with applicable state or federal laws or regulations, that portion shall be considered void. The remainder of this policy shall not be affected thereby and shall remain in full force and effect.
- III. PURPOSE: To create and implement a multimodal transportation policy that encourages safe access and mobility for users of all ages and abilities through the planning, design, construction, maintenance, and operation of new construction, reconstruction and retrofit transportation facilities that are federally or state funded. Users include, but are not limited to, motorists, transit-riders, freight-carriers, bicyclists and pedestrians.
- IV. APPLICATION: All Tennessee Department of Transportation (TDOT) employees, consultants and contractors involved in the planning, design, construction, maintenance, and operation of state and federally funded projects, and local governments managing and maintaining transportation projects with funding through TDOT's Local Programs Development Office.
- V. DEFINITIONS:
 - a. Highway: A main road or thoroughfare, such as a street, boulevard, or parkway, available to the public for use for travel or transportation
 - b. Multimodal: For the purposes of this policy, multimodal is defined as the movement of people and goods on state and functionally-classified roadways. Users include, but are not limited to, motorists, transit-riders, freight-carriers, bicyclists and pedestrians, including those with disabilities.
 - c. Reconstruction: Complete removal and replacement of the pavement structure or the addition of new continuous traffic lanes on an existing roadway.
 - d. Retrofit: Changes to an existing highway within the general right-of-way, such as adding lanes, modifying horizontal and vertical alignments, structure rehabilitation, safety improvements, and maintenance.
 - e. Roadway: The portion of a highway, including shoulders, that is available for vehicular, bicycle or pedestrian use.

EXHIBIT 1-3: TDOT MULTIMODAL POLICY (2 OF 4)

Policy Number: 530-01
Effective Date: 7/31/15

VI. POLICY: The Department of Transportation recognizes the benefits of integrating multimodal facilities into the transportation system as a means to improve the mobility, access and safety of all users. The intent of this policy is to promote the inclusion of multimodal accommodations in all transportation planning and project development activities at the local, regional and statewide levels, and to develop a comprehensive, integrated, and connected multimodal transportation network. TDOT will collaborate with local government agencies and regional planning agencies through established transportation planning processes to ensure that multimodal accommodations are addressed throughout the planning, design, construction, maintenance, and operation of new construction, reconstruction and retrofit transportation facilities as outlined in TDOT's Multimodal Access Policy Implementation Plan.

VII. PROCEDURES:

A. TDOT is committed to the development of a transportation system that improves conditions for multimodal transportation users through the following actions:

1. Provisions for multimodal transportation shall be given full consideration in new construction, reconstruction and retrofit roadway projects through design features appropriate for the context and function of the transportation facility.
2. The planning, design and construction of new facilities shall give full consideration to likely future demand for multimodal facilities and not preclude the provision of future improvements. If all feasible roadway alternatives have been explored and suitable multimodal facilities cannot be provided within the existing or proposed right of way due to environmental constraints, an alternate route that provides continuity and enhances the safety and accessibility of multimodal travel should be considered.
3. Multimodal provisions on existing roadways shall not be made more difficult or impossible by roadway improvements or routine maintenance projects.
4. Intersections and interchanges shall be designed (where appropriate based on context) to accommodate the mobility of bicyclists and pedestrians to cross corridors as well as travel along them in a manner that is safe, accessible, and convenient.
5. While it is not the intent of resurfacing projects to expand existing facilities, opportunities to provide or enhance bicycle and pedestrian facilities shall be given full consideration during the program development stage of resurfacing projects.
6. Pedestrian facilities shall be designed and built to accommodate persons with disabilities in accordance with the access standards required by the Americans with Disabilities Act (ADA). Sidewalks, shared use paths, street crossings

EXHIBIT 1-4: TDOT MULTIMODAL POLICY (3 OF 4)

Policy Number: 530-01

Effective Date: 7/31/15

(including over- and under-crossings) and other infrastructure shall be constructed so that all pedestrians, including those with disabilities, can travel independently.

7. Provisions for transit riders, pedestrians, and bicyclists shall be included when closing roads, bridges or sidewalks for construction projects where pedestrian, bicycle, or transit traffic is documented or expected.
- B. It is TDOT's expectation that full consideration of multimodal access will be integrated in all appropriate new construction, reconstruction and retrofit infrastructure projects. However, there are conditions where it is generally inappropriate to provide multimodal facilities. Examples of these conditions include, but are not limited to:
1. Controlled access facilities where non-motorized users are prohibited from using the roadway. In this instance, a greater effort may be necessary to accommodate these users elsewhere within the same transportation corridor.
 2. The cost of accommodations would be excessively disproportionate to the need and probable use. Excessively disproportionate is defined as exceeding twenty percent (20%) of the cost of the project. The twenty percent figure should be used in an advisory rather than an absolute sense, especially in instances where the cost may be difficult to quantify. Compliance with ADA requirements may require greater than 20% of project cost to accommodate multimodal access. Costs associated with ADA requirements are NOT an exception.
 3. Areas in which the population and employment densities or level of transit service around the facility, both existing and future, does not justify the incorporation of multimodal alternatives.
 4. Inability to negotiate and enter into an agreement with a local government to assume the operational and maintenance responsibility of the facility.
 5. Other factors where there is a demonstrated absence of need or prudence, or as requested by the Commissioner of the Department of Transportation.
- C. Exceptions for not accommodating multimodal transportation users on State roadway projects in accordance with this policy shall be documented describing the basis and supporting data for the exception, and must be approved by TDOT's Chief Engineer and Chief of Environment or their designees.
- D. The Department recognizes that a well-planned and designed transportation network is responsive to its context and meets the needs of its users. Therefore, facilities will be designed and constructed in accordance with current applicable laws and regulations, using best practices and guidance, including but not limited to the following: TDOT Standard Drawings and guidelines, American Association of State Highway and Transportation Officials (AASHTO) publications, Institute of

EXHIBIT 1-5: TDOT MULTIMODAL POLICY (4 OF 4)

<table border="1"> <tr> <td>Policy Number: 530-01</td> </tr> <tr> <td>Effective Date: 7/31/15</td> </tr> </table>	Policy Number: 530-01	Effective Date: 7/31/15
Policy Number: 530-01		
Effective Date: 7/31/15		
<p>Transportation Engineers (ITE) publications, the Manual of Uniform Traffic Control Devices (MUTCD), National Association of City Transportation Officials (NACTO) publications, the Public Rights-of-Ways Accessibility Guidelines (PROWAG), and the Americans with Disabilities Act Accessibility Guidelines (ADAAG).</p>		

1.3 USDOT POLICY STATEMENT ON BICYCLE AND PEDESTRIAN ACCOMMODATION

The United States Department of Transportation (USDOT) policy is to incorporate walking and bicycling facilities into transportation projects. The USDOT policy statement notes that every transportation agency has the responsibility to improve conditions and opportunities for walking and bicycling and to integrate walking and bicycling into their transportation systems. Because of the numerous individual and community benefits that walking and bicycling provide — including health, safety, environmental, transportation, and quality of life — transportation agencies are encouraged to go beyond minimum standards to provide safer and more convenient facilities for these modes. This USDOT policy was signed March 11, 2010 and announced March 15, 2010.

1.4 FHWA DESIGN FLEXIBILITY GUIDANCE

Historically, 13 controlling design criteria had been identified by FHWA as having substantial importance to the operational and safety performance of highways on the National Highway System (NHS). On October 7, 2015, FHWA published a notice in the Federal Register soliciting comments on proposed changes to the 1985 policy establishing 13 controlling criteria for design. The October notice clarified when design exceptions are required and the documentation that is expected to support such requests. After considering the comments received, FHWA published a final notice in the Federal Register on May 5, 2016. The published final notice can be viewed at <https://www.gpo.gov/fdsys/pkg/FR-2016-05-05/pdf/2016-10299.pdf>.

The revised change to controlling criteria policy reduced the number of controlling criteria from 13 to 10 for Interstate highways, other freeways, and on other roadways on the NHS with design speeds ≥ 50 miles per hour (mph). The following 10 criteria are considered controlling for these high-speed roadways: design speed, lane width, shoulder width, horizontal curve radius, superelevation rate, stopping sight distance, maximum grade, cross slope, vertical clearance, and design loading structural capacity. The three criteria eliminated were bridge width, vertical alignment, and lateral offset to obstruction.

<p><u>AASHTO Roadway Design Speed Classification</u></p> <p>Low-speed is typically ≤ 45 mph</p> <p>High-speed is typically ≥ 50 mph.</p>

On non-NHS roadways and NHS roadways with a design speed ≤ 45 mph, the controlling criteria were reduced from 13 to 2. Only design loading structural capacity and design speed apply to these routes. The policy also clarified when design exceptions are needed and the documentation that is expected to support such requests. These changes provide considerable design flexibility, especially on low-speed routes. The controlling criteria are summarized in Exhibit 1-6. Additional information is provided in the following paragraphs.

EXHIBIT 1-6: CONTROLLING CRITERIA REQUIRING FHWA DESIGN EXCEPTION

NHS Route and Speed \geq 50 mph	Non-NHS or NHS and Speed \leq 45 mph
Design Speed Lane Width Shoulder Width Horizontal Curve Radius Superelevation Rate Stopping Sight Distance Maximum Grade Cross Slope Vertical Clearance Design Loading Structural Capacity	Design Speed Design Loading Structural Capacity

Source: Data from FHWA Federal Register Notice on May 5, 2016

FHWA requires a written design exception if design criteria on the NHS are not met for any of the controlling criteria. Exceptions may be approved on a project-by-project basis for designs that do not conform to the minimum or limiting criteria. Design exceptions, subject to approval by FHWA, are required for projects on the NHS only when the controlling criteria described above are not met. FHWA expects documentation of design exceptions to include all of the following:

- Specific design criteria that will not be met
- Existing roadway characteristics
- Alternatives considered
- Comparison of the safety and operational performance of the roadway and other impacts such as right-of-way, community, environmental, cost, and usability by all modes of transportation
- Proposed mitigation measures
- Compatibility with adjacent sections of roadway

The level of analysis should be commensurate with the complexity of the project.

Design speed and design loading structural capacity are fundamental criteria in the design of a project. Exceptions to these criteria should be extremely rare and FHWA expects the documentation to provide the following additional information:

- Design speed exceptions:
 - Length of section with reduced design speed compared to overall length of project
 - Measures used in transitions to adjacent sections with higher or lower design or operating speeds
- Design loading structural capacity exceptions:
 - Verification of safe load-carrying capacity (load rating) for all state unrestricted legal loads or routine permit loads, and in the case of bridges and tunnels on the Interstate, all federal legal loads

The approval of deviations from applicable design criteria are to be handled as follows:

- **NHS roadway and controlling criteria not met:** Design exceptions are required and FHWA is the approving authority
- **NHS roadway and non-controlling criteria not met:** TDOT is the approving authority for design deviations in accordance with state laws, regulations, directives, and safety standards
- **Non-NHS roadway and state design criteria not met on federal-aid projects:** TDOT is the approving authority for design deviations in accordance with state laws, regulations, directives, and safety standards

1.5 FHWA BICYCLE AND PEDESTRIAN FACILITY DESIGN FLEXIBILITY

On August 20, 2013, FHWA issued a memorandum that expresses FHWA's support for taking a flexible approach to bicycle and pedestrian facility design. The memo notes that The American Association of State Highway and Transportation Officials (AASHTO) Bicycle and Pedestrian Design Guides are the primary national resources for planning, designing, and operating bicycle and pedestrian facilities.

NACTO's *Urban Bikeway Design Guide* and the Institute of Transportation Engineers (ITE) *Designing Urban Walkable Thoroughfares* builds upon the flexibilities provided in the AASHTO guides, which can help communities plan and design safer and more convenient facilities for pedestrians and bicyclists. FHWA supports the use of these resources to further develop non-motorized transportation networks, particularly in urban areas.

1.6 FHWA STRATEGIC AGENDA FOR PEDESTRIAN AND BICYCLE TRANSPORTATION

The *Strategic Agenda for Pedestrian and Bicycle Transportation* is a framework to guide FHWA's pedestrian and bicycle initiatives and investments during the five-year period from federal fiscal year (FY) 2016-17 to FY 2020-21.

Developed with input from a broad range of technical experts, transportation agency staff, and stakeholders from across the nation, the agenda articulates goals and supporting actions to promote safer, accessible, comfortable, and connected bicycle and pedestrian networks; advance ladders of opportunity and community connections; provide equitable access for everyone to jobs, schools, and essential services; and to expand transportation options and choices for all.

FHWA is committed to making all travel modes, including walking and bicycling, safer, accessible, comfortable, and convenient for everyone. Investing in these modes yields multiple benefits to the nation:

- Improved safety for travelers of all ages and abilities
- Improved mobility for all people and businesses
- Improved access to jobs and essential services for all
- Increased resilience for all communities

1.7 TDOT ACCESSIBILITY GUIDANCE

As noted in TDOT's *Multimodal Access Policy* (see Section 1.2), pedestrian facilities shall be designed and built to accommodate persons with disabilities in accordance with the access standards required by the ADA to the maximum extent feasible or to the extent that it is not structurally impracticable. Sidewalks, shared-use paths, street crossings, and other infrastructure shall be constructed so that all pedestrians, including those with disabilities, can travel independently.

Furthermore, on November 7, 2014, TDOT began using the United States Access Board's *Proposed Guidelines for Pedestrian Facilities in the Public Right-of-Way*. These guidelines serve as the *Public Rights-of-Ways Accessibility Guidelines*, or PROWAG. Notification of TDOT's adoption of PROWAG is provided in Exhibit 1-7.

The design recommendations in this *Multimodal Project Scoping Manual* are consistent with current ADA and PROWAG guidance. If any portion is determined to be in conflict with future ADA or PROWAG guidance, that portion shall be considered void.

EXHIBIT 1-7: TDOT PROWAG ADOPTION



STATE OF TENNESSEE
DEPARTMENT OF TRANSPORTATION

BUREAU OF ENGINEERING
SUITE 700, JAMES K. POLK BUILDING
505 DEADERICK STREET
NASHVILLE, TENNESSEE 37243-1402
(615) 741-0791

JOHN C. SCHROER
COMMISSIONER

BILL HASLAM
GOVERNOR

MEMORANDUM

DATE: November 7, 2014

TO: Bureau of Engineering and the
Bureau of Environment and Planning

FROM: Paul D. Degges, P.E. *PDD*
Deputy Commissioner and Chief Engineer

RE: **Public Right of Way Standards**

Effective immediately, the Department of Transportation will begin using the Proposed Accessibility Guidelines for Pedestrian Facilities in the Public Right-of Way", which were printed in the July 26, 2011 as our standard ROW guidelines.

You can obtain a copy of these standards at www.access-board.gov or by contacting our ADA Coordinator, Ms. Margaret Mahler, at 741-4984 or at Margaret.Z.Mahler@tn.gov.

When the previous ADA Accessibility Guidelines, 28 CFR part 36, 1994 were updated in 2010, the new standards did not address ROW standards, only vertical ones. The adoption of these new standards will give the needed guidance for ROW without the requirement of vertical standards.

Until the standards are adopted by the Department of Justice, FHWA has allowed each state DOT to adopt the PROWAG 2011 standards to ensure consistent application of the ADA. TDOT chose to adopt the new standards across the board in all plans, contract documents, and local guidelines.

If you have any questions, please do not hesitate to contact me.

PDD/MM/jc

Cc: Mr. Toks Omishakin
Ms. Margaret Mahler

1.8 SECTION 1.0 SOURCES

1. Department of Transportation, Federal Highway Administration. (n.d.). Federal Register (87th ed., Vol. 81, Thursday, May 5, 2016). Washington, D.C.: Office of the Federal Register, National Archives and Records Service, General Services Administration. Revision of Thirteen Controlling Criteria for Design and Documentation of Design Exceptions. Retrieved October 24, 2016, from <https://www.gpo.gov/fdsys/pkg/FR-2016-05-05/pdf/2016-10299.pdf>
2. Department of Transportation, Federal Highway Administration Memorandum on Bicycle and Pedestrian Facility Design Flexibility. Retrieved on December 16, 2016 from https://www.fhwa.dot.gov/environment/bicycle_pedestrian/guidance/design_flexibility.cfm
3. Department of Transportation, Federal Highway Administration. (2016). *Strategic Agenda for Pedestrian and Bicycle Transportation*. Washington, D.C. Retrieved on February 21, 2018 from https://www.fhwa.dot.gov/environment/bicycle_pedestrian/publications/strategic_agenda/
4. Design Standards. (2016, October 6). Retrieved October 24, 2016, from <http://www.fhwa.dot.gov/programadmin/standards.cfm>
5. Design Standards and Section 1404 of the FAST Act Questions & Answers. (2016, October 6). Retrieved October 24, 2016, from <https://www.fhwa.dot.gov/design/standards/161006qa.cfm>
6. United States Access Board. (2011). *Proposed Accessibility Guidelines for Pedestrian Facilities in the Public Right-of-Way*. Washington, D.C.
7. United States Department of Transportation Policy Statement on Bicycle and Pedestrian Accommodation Regulations and Recommendations. Retrieved December 16, 2016 from http://www.fhwa.dot.gov/environment/bicycle_pedestrian/guidance/policy_accom.cfm

[This page intentionally left blank]

2.0 MULTIMODAL DESIGN BACKGROUND

Designing a multimodal street is not a one-size-fits-all approach. It requires an analysis of various site conditions to determine appropriate treatments and solutions. Factors that should be considered include the physical characteristics of the street, urban vs. suburban vs. rural context, surrounding land uses, collision history, and expected pedestrian, bicycle, and motor vehicle demand. Treatments can vary from installing physical infrastructure, to altering signalization, to simply reinforcing safety efforts with signage. Funding is also a major factor concerning what types of treatments are feasible for certain projects. Important items to consider include:

- Not every street has to have sidewalks, bicycle lanes, and transit
- One size (design) does not fit all situations
- Fit the current and planned context of the street, corridor, and local community with the design of the street
- Land use context and transportation facility needs should complement each other

2.1 LAND USE CONTEXT

The appropriate design for, and operation of, a street must take into account the existing and future surrounding land use. Many agencies have gone beyond utilizing just three land use contexts (rural, suburban, urban) to more numerous and descriptive categories, including: Natural, Rural, Suburban, General Urban, Urban Center, Urban Core, and Districts (see Exhibit 2-1). This *Multimodal Project Scoping Manual* will typically utilize the three primary land use contexts of rural, suburban, and urban, but will provide additional descriptions when necessary, typically including rural (town) and urban (core).

Concerning land use context, the designer should:

- Consider both the existing conditions and the plans for the future by reviewing the area's planning documents and zoning. Project travel demand for all modes within the project limits. Recognize that streets often last longer than adjacent buildings
- Acknowledge when a project crosses multiple context zones that the street's design characteristics, including its typical section, may need to be varied accordingly (i.e. a corridor that transitions from suburban to urban, or residential to retail)
- Identify current levels of pedestrian, bicycle, and transit activity or estimate future levels based on the type, mix, and proximity of land uses

EXHIBIT 2-1: LAND USE CONTEXTS

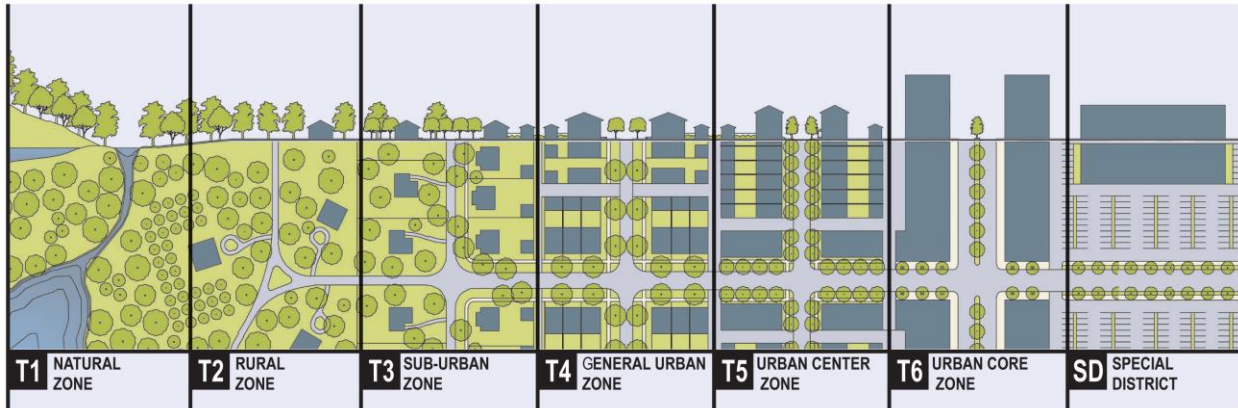

Source: Center for Applied Transect Studies

2.2 DESIGN FLEXIBILITY

Applying flexibility requires knowledge of existing standards and guidelines, a recognition of the range of options available, and an understanding of how deviating from these may impact safety and mobility. A flexible approach uses existing tools in creative and varied ways to solve design challenges. It requires a holistic understanding of variables, thresholds, and available alternatives to achieve multiple objectives.

AASHTO’s *A Policy on Geometric Design of Highways and Streets* (Green Book) and the supplemental guides for pedestrian and bicycle facility design are the national guidelines for the design of streets and paths. The Green Book has been adopted by FHWA as the standard for the design of projects on the National Highway System (NHS). These AASHTO guides are the basis of TDOT’s design manuals.

The Green Book emphasizes the need for a holistic design approach and the use of engineering judgment, and highlights how the guidelines allow for flexibility:

“The intent of this policy is to provide guidance to the designer by referencing a recommended range of values for critical dimensions. Good highway design involves balancing safety, mobility, and preservation of scenic, aesthetic, historic, cultural, and environmental resources. This policy is therefore not intended to be a detailed design manual that could supersede the need for the application of sound principles by the knowledgeable design professional. Sufficient flexibility is permitted to encourage independent designs tailored to particular situations.” (AASHTO Green Book 2011, p. xii)

2.3 DESIGN FLEXIBILITY AND RISK

Designers sometimes express concern about risk when applying design flexibility. Due to these concerns, some designers adhere strictly to their interpretation of established design criteria, sometimes at the expense of providing adequate bicycle and pedestrian facilities. However, strictly adhering to the most conservative design values without considering other relevant factors may not constitute reasonable care on behalf of the designer. Likewise, a designer who deviates from established design guidance is not necessarily negligent, particularly if the designer follows and documents a clear process, using engineering judgment, when dealing with design exceptions, and experimentation.

A flexible design approach has three key elements:

(1) Engineering Judgment, (2) Documentation and (3) Experimentation

1. Engineering Judgment

Engineering judgment relies on understanding engineering principles and the assumptions and contingencies incorporated into standards and guidelines. It requires knowledge and understanding of site specific conditions. The Manual on Uniform Traffic Control Devices (MUTCD) defines engineering judgment as “the evaluation of available pertinent information, and the application of appropriate principles, provisions, and practices” and states “this Manual should not be considered a substitute for engineering judgment.”

To apply design flexibility appropriately, the impacts of different design criteria on all roadway users should be weighed and examined using engineering judgment to determine the most appropriate application of, or deviation from, guidance to achieve the optimal solution. Decision makers should consider safety and comfort alongside competing needs for limited space, resources, and funding – while also accounting for the scenic, historic, aesthetic, and cultural values and plans of the surrounding community.

Public input is another consideration when exercising engineering judgment. It is important to understand the opinions and preferences of the people who use, wish to use, or are affected by the transportation facility. In some cases, the general public may not understand certain aspects of technical design, or may have misconceptions about what design treatments are most effective. The designer’s role is to not only consider public opinion, but to also educate people about design solutions that may address underlying concerns.

2. Documentation

Designers should document design decisions, especially when applying design flexibility. Memoranda, engineering studies, and other methods of documentation can be used to capture the engineering judgment behind a design solution and build a case for applying flexibility or deviating from existing guidance. In some cases, depending on the design criteria involved, applying flexibility may trigger the need for a design exception (see Section 1.4). Documenting design decisions is usually a critical part of the design exception process.

3. Experimentation

When deviating from current guidance and design standards, concerns should not limit innovations, experimentation, and versatile applications of existing design treatments and proven

safety countermeasures. In the case of traffic control devices, experimentation may be possible if the proposed design is not compliant with, or not included in, the MUTCD. Section 1A.10 of the MUTCD outlines a formal experimentation process that includes evaluation and follow-up adjustments to the design (including removal of the design) as needed. The experimentation process helps drive the advancement of the design practice and the adoption of new traffic control devices in the MUTCD. Without conclusive data detailing their impact, new traffic control devices would not be given national approval. Experimentation with newer traffic control devices and facility types such as pedestrian hybrid beacons, bicycle signals, and colored pavement markings have expanded the designer's toolbox by providing the data necessary to show the success of these measures. It is typically acknowledged that no area of transportation engineering design has progressed as much since the publication of the 2009 Edition of the MUTCD than that of bicycle and pedestrian facilities. While the 2009 MUTCD addresses some of these emerging designs, such as buffered bike lanes and bike lane extensions, it is silent on other new developments in design since that time. This is an area where the formal experimentation process has been especially beneficial. On state or federally funded projects, local agencies should coordinate with TDOT to determine if experimentation and subsequent approval with a desired traffic control device has already gained statewide approval. Cost considerations for local agencies including potential up-front costs and maintenance agreements associated with experimental devices should also be coordinated.

2.4 BALANCING LEVEL, QUALITY, AND SAFETY OF SERVICE

There is no single set of templates to create a multimodal street. The appropriate accommodation for each mode of travel is dependent on land use and transportation conditions such as building uses, building types, setbacks, traffic volume (by mode), traffic speed (also by mode), and local preferences. The goal is to balance the needs of each mode.

A traffic or design engineer may evaluate a street segment using the *Highway Capacity Manual* (HCM) in an effort to assess and balance the needs of each mode. This analysis could result in independent levels of service for pedestrians, bicyclists, transit users, and motor vehicle drivers. A solution could be sought that would provide equivalent levels of service for each mode.

Another approach is to emphasize safety by prioritizing the needs of the most vulnerable users of the street. Pedestrians and bicyclists, as the most vulnerable street users, receive priority in this case.

Traditional measures of effectiveness that include motor vehicle speed, delay, and crash rate will always be important when assessing the performance of a street. However, as livability has become an emphasis of transportation policy at federal, state, and local levels, it should also be understood that urban streets also serve as economic engines; investments in the character of a street in lieu of its throughput have been shown to increase retail rents, residential property values, and livability of an area. Streets designed for walking, bicycling, and transit also contribute to public health benefits.

The goal of a successful multimodal project is to meet the needs of ALL users of a street, while being good stewards of limited financial resources.

2.5 MOTOR VEHICLE, BICYCLISTS, AND PEDESTRIAN ACCOMMODATIONS

Descriptive cases for a range of multimodal accommodations are discussed in Sections 2.5.1 through 2.5.5 to demonstrate accommodation approaches that may be applicable in a variety of contexts. The first three cases describe roadway sections bounded by curb and sidewalk. These cases are most likely to be found in more densely developed areas such as rural town centers, suburban, and urban zones. The remaining two cases are for areas without curb and sidewalk and are most likely to be found in the less developed rural area types.

2.5.1 Separate Accommodation for All Users

Separate accommodation for all users provides the optimum accommodation for all modes of travel in many settings (see Exhibit 2-2). Key attributes include the following:

- Often the preferred option to provide safer, convenient, and comfortable travel for all users
- Appropriate for areas with moderate to high levels of pedestrian and bicycle demand or activity
- Appropriate for streets with moderate to high motor vehicle speeds
- Appropriate in areas without substantial environmental or right-of-way constraints
- Pedestrians are provided with a sidewalk separated from the roadway by a raised curb and preferably a landscaped buffer
- A bicycle lane, off street path, cycle track, or shoulder suitable for bicycle use is provided

EXHIBIT 2-2: SEPARATE ACCOMMODATION FOR ALL USERS

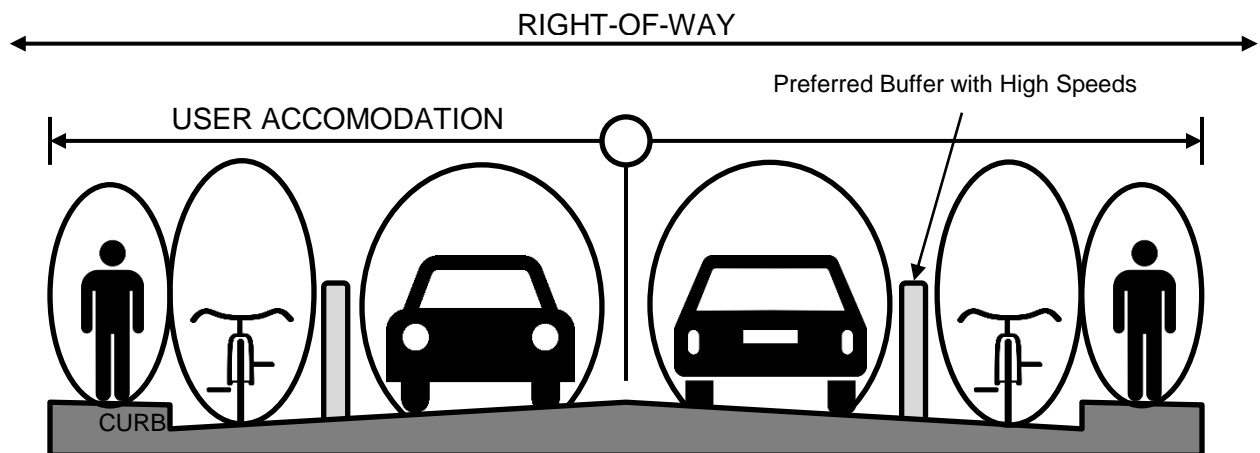

2.5.2 Partial Sharing for Bicycles and Motor Vehicles

There are instances in which the width necessary to provide optimal accommodation for all users is not available. There are also instances where some sharing and overlap between bicyclists and motor vehicle traffic is acceptable to achieve other environmental or design objectives. Partial sharing for bicycles and motor vehicles is an approach to multimodal accommodation in these situations (see Exhibit 2-3). Key attributes include the following:

- Used in areas where the width necessary to provide separate accommodation for all users is not available
- Pedestrians are provided with a sidewalk or separate path while space for bicyclists and drivers overlaps somewhat
- Appropriate in areas with low motor vehicle speeds and low to moderate motor vehicle volumes
- Pedestrians are provided with a sidewalk separated from the roadway by a raised curb and preferably a landscaped buffer
- Typical travel lanes combined with narrow shoulders provide maneuvering width for truck and bus traffic within the travel lane; however, bicyclists may be forced to ride along and over the pavement markings
- Narrow travel lanes combined with wide shoulders provide greater separation between motor vehicle and bicycle traffic, but may result in motor vehicle traffic operating closer to the center line or occasionally encroaching into the opposing travel lane

EXHIBIT 2-3: PARTIAL SHARING FOR BICYCLES AND MOTOR VEHICLES

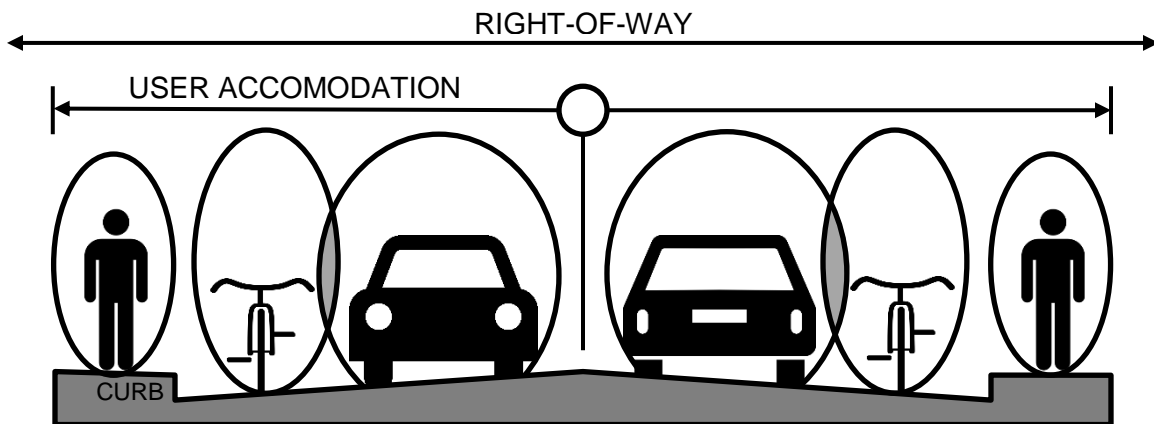

2.5.3 Shared Bicycle/Motor Vehicle Accommodation

With this option, the accommodation of bicycles and motor vehicles is shared and separate pedestrian accommodation is maintained (see Exhibit 2-4). Shared bicycle/motor vehicle accommodation is most likely to be found in the most densely developed urban areas where right-of-way is most constrained. Key attributes include the following:

- Pedestrians remain separate but bicycle and motor vehicle space is shared
- Used in densely developed areas where right-of-way is constrained
- Also applicable to most residential/local streets where speeds and traffic volumes are low
- Pedestrians are provided with a sidewalk separated from the roadway by a raised curb and preferably a landscaped buffer
- Signs and pavement markings indicating that the roadway is shared between cyclists and motor vehicles should be provided. On-street parking is often found on these streets and separate shoulders or bicycle lanes are not available

EXHIBIT 2-4: SHARED BICYCLE/MOTOR VEHICLE ACCOMMODATION

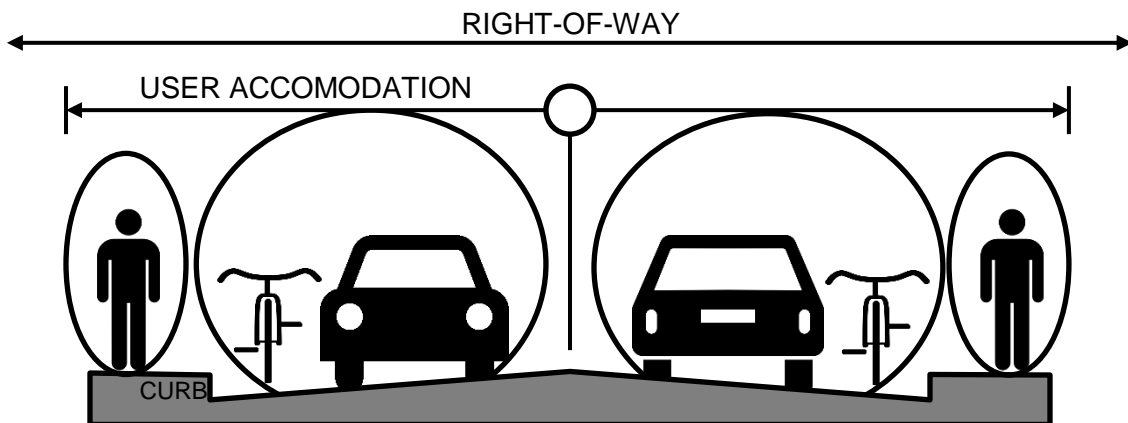

2.5.4 Shared Bicycle/Pedestrian Accommodation

In sparsely developed rural and low-density suburban areas, curbed roadway sections bounded by sidewalk are less common. In these areas, pedestrians and cyclists often use the roadway shoulder (see Exhibit 2-5). It should be noted that a shoulder with a typical four (4) percent cross slope is not considered an acceptable ADA compliant pedestrian route, although pedestrians may use it to stay out of the travel lanes or unimproved roadside areas. Key attributes include the following:

- A preferred shared bicycle/pedestrian accommodation is to provide an off-street shared-use path
- Pedestrians and bicyclists share the shoulder
- Common in rural or sparsely developed areas
- Appropriate for areas with infrequent pedestrian and bicycle use
- Typical travel lanes combined with wide shoulders provide for increased separation between pedestrians, bicyclists, and motor vehicles. Wider shoulders also provide clearance for emergency stopping and maneuvering
- Typical travel lanes combined with narrow shoulders provide maneuvering width for truck and bus traffic within the travel lane, reducing encroachment into opposing lanes and the shoulder. However, conflicts between bicycles and pedestrians are more likely
- Narrow travel lanes combined with wide shoulders provide greater separation between bicyclists and pedestrians, but may result in motor vehicle traffic operating closer to the center line or encroaching on the shoulder

EXHIBIT 2-5: SHARED BICYCLE/PEDESTRIAN ACCOMMODATION

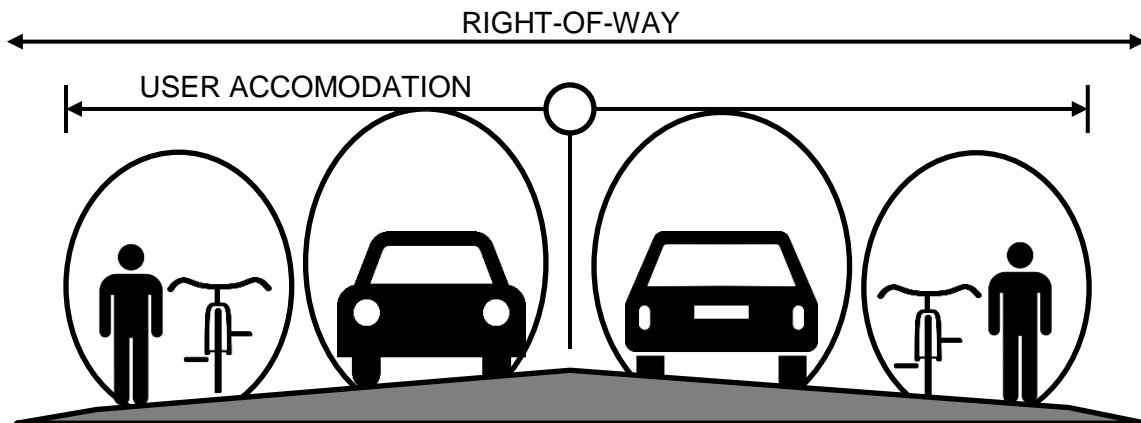

2.5.5 Shared Accommodation for All Users

Vehicles, bicycles, and pedestrians are sometimes accommodated in one shared travel lane (see Exhibit 2-6). This condition occurs when there is low user demand and speeds are very low, or when severe constraints limit the feasibility of providing shoulders. Key attributes include the following:

- All users share the roadway.
- Appropriate where user demands and motor vehicle speeds are very low or when severe constraints limit the feasibility of providing separate accommodation.

EXHIBIT 2-6: SHARED ACCOMMODATION FOR ALL USERS

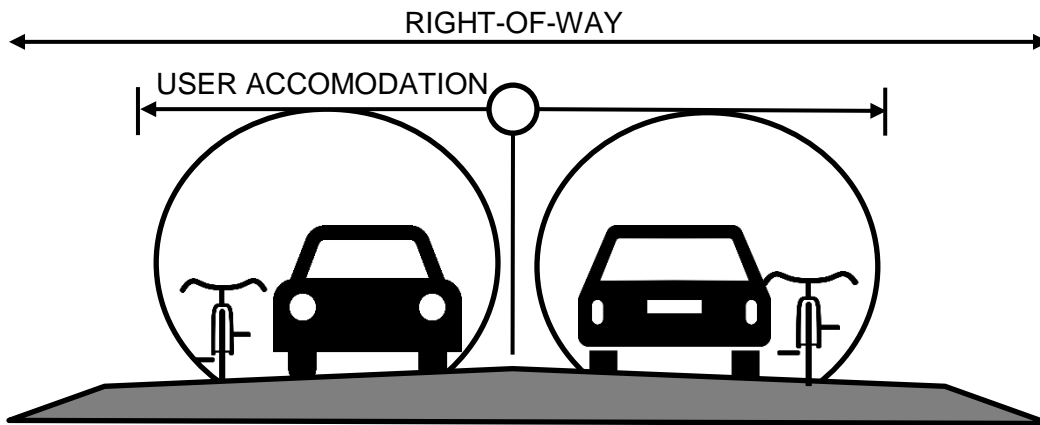

2.6 MULTIMODAL FUNCTIONAL CLASSIFICATION SYSTEM MATRIX

Exhibit 2-7 provides a multimodal functional classification system (FCS) that presents treatment options for each user (driver, bicyclist, and pedestrian) and identifies the interactions along typical land use contexts and roadway classifications. Proper contextual street designs require an understanding of how the street functions in its context and the needs of the potential street users. Exhibit 2-7 can be used to identify preliminary multimodal element features that should be given consideration when assessing current and future roadway context and user needs.

EXHIBIT 2-7: FUNCTIONAL CLASSIFICATION SYSTEM MATRIX

Context/ Roadway		Rural	Rural (Town)	Suburban	Urban	Urban (Core)
Principal Arterial	V	High Speed High Mobility Low Access	Low/Med. Speed Med. Mobility High Access	Med./High Speed Med. Mobility Med. Access	Low/Med. Speed Med. Mobility Med. Access	Low Speed Med. Mobility Med. Access
	B	LC: Low Separation NC: Med. Separation CC: High Separation	LC: Low Separation NC: Med. Separation CC: Med. Separation	LC: Low Separation NC: Med. Separation CC: High Separation	LC: Low Separation NC: Med. Separation CC: High Separation	LC: Low Separation NC: Med. Separation CC: Med. Separation
	P	Low Ped: Min. Med. Ped: Wide High Ped: Wide	Low Ped: Min. Med. Ped: Wide High Ped: Enhanced	Low Ped: Min. Med. Ped: Wide High Ped: Wide	Low Ped: Min. Med. Ped: Wide High Ped: Enhanced	Low Ped: Min. Med. Ped: Wide High Ped: Enhanced
Minor Arterial	V	High Speed High Mobility Med. Access	Low/Med. Speed Med. Mobility High Access	Med. Speed Med. Mobility Med. Access	Low/Med. Speed Med. Mobility Med./High Access	Low Speed Med. Mobility Med./High Access
	B	LC: Low Separation NC: Med. Separation CC: High Separation	LC: Low Separation NC: Med. Separation CC: Med. Separation	LC: Low Separation NC: Med. Separation CC: High Separation	LC: Low Separation NC: Med. Separation CC: Med. Separation	LC: Low Separation NC: Med. Separation CC: Med. Separation
	P	Low Ped: Min. Med. Ped: Wide High Ped: Wide	Low Ped: Min. Med. Ped: Wide High Ped: Enhanced	Low Ped: Min. Med. Ped: Wide High Ped: Wide	Low Ped: Min. Med. Ped: Wide High Ped: Enhanced	Low Ped: Min. Med. Ped: Wide High Ped: Enhanced
Collector	V	Med. Speed Med. Mobility Med. Access	Low Speed Med. Mobility High Access	Med. Speed Med. Mobility High Access	Low Speed Med. Mobility High Access	Low Speed Med. Mobility High Access
	B	LC: Low Separation NC: Med. Separation CC: Med. Separation	LC: Low Separation NC: Low Separation CC: Med. Separation	LC: Low Separation NC: Med. Separation CC: Med. Separation	LC: Low Separation NC: Med. Separation CC: Med. Separation	LC: Low Separation NC: Low Separation CC: Med. Separation
	P	Low Ped: Min. Med. Ped: Wide High Ped: Wide	Low Ped: Min. Med. Ped: Wide High Ped: Enhanced	Low Ped: Min. Med. Ped: Wide High Ped: Wide	Low Ped: Min. Med. Ped: Wide High Ped: Enhanced	Low Ped: Min. Med. Ped: Wide High Ped: Enhanced
Local	V	Med. Speed Med. Mobility Med. Access	Low Speed Med. Mobility High Access	Low Speed Low Mobility High Access	Low Speed Low Mobility High Access	Low Speed Low Mobility High Access
	B	LC: Low Separation NC: Low Separation CC: Low Separation	LC: Low Separation NC: Low Separation CC: Low Separation	LC: Low Separation NC: Low Separation CC: Low Separation	LC: Low Separation NC: Low Separation CC: Low Separation	LC: Low Separation NC: Low Separation CC: Low Separation
	P	Low Ped: Min. Med. Ped: Wide High Ped: Wide	Low Ped: Min. Med. Ped: Wide High Ped: Enhanced	Low Ped: Min. Med. Ped: Wide High Ped: Wide	Low Ped: Min. Med. Ped: Wide High Ped: Enhanced	Low Ped: Min. Med. Ped: Wide High Ped: Enhanced

Source: Example Guidance derived from Draft NCHRP 15-52 Figure 13

Notes:

- V = Vehicular, B = Bicycle Facility, P = Pedestrian Facility
- For Bicycle Facilities: Separation from vehicular travel ways described for the following connectors: Local (LC), Neighborhood (NC), and Citywide (CC). Separation can be obtained via wider than minimum geometry or physical barriers. Low separation can include shared-use facilities when vehicular volumes and speeds are low.
- For Pedestrian Facilities: N/A = Not Appropriate, Min. = Minimum Standard, Wide = Wider than Standard, Enhanced = wide for large congregating pedestrian groups.

2.7 MULTIMODAL STREET EXAMPLES

It should be understood that multimodal streets have many different functions and appearances dependent upon their intended users, land use context, and appropriate design flexibility utilized. Exhibit 2-8 through Exhibit 2-15 provide examples of multimodal streets that meet the needs of their users and fit the context with their surroundings.

EXHIBIT 2-8: SUBURBAN LOW TRAFFIC, LOW-SPEED, MODE-SHARED RESIDENTIAL STREET



Source: Dan Burden, Walkable and Livable Communities Institute

EXHIBIT 2-9: RURAL HIGHWAY WITH PAVED SHOULDER



EXHIBIT 2-10: RURAL ROAD WITH SEPARATED SHARED-USE PATH



Source: Dan Burden, Walkable and Livable Communities Institute

EXHIBIT 2-11: LOW-DENSITY SUBURBAN STREET



EXHIBIT 2-12: HIGH-DENSITY SUBURBAN STREET



EXHIBIT 2-13: URBAN TOWN MAIN STREET



EXHIBIT 2-14: URBAN MAIN STREET



Source: <http://chicagocompletestreets.org/streets/bikeways/buffer-protected-bike-lanes/>

EXHIBIT 2-15: URBAN CORE STREET



Source: Google Maps, 5th Ave Portland, OR

2.8 WHEN TO CONSTRUCT SEPARATE MULTIMODAL ACCOMMODATIONS

TDOT’s Multimodal Access Policy (see Section 1.2) notes the intent to promote the inclusion of multimodal accommodations in all transportation planning and project development activities at the local, regional, and statewide levels, and to develop a comprehensive, integrated, and connected multimodal transportation network.

For multimodal streets, the selection and design of appropriate accommodations requires an assessment of the users benefited. The degree of non-motorized/transit use and their needs should be determined during the project planning or concept development phase. Defining these will often require local input.

Commonly applied non-motorized user accommodations include sidewalks, curb ramps, pedestrian crossings, bicycle lanes, bikeable shoulders, shared-use paths, pedestrian activated signals, and midblock treatments such as marked crosswalks and median islands.

Transit accommodations address pedestrian access to and from transit stops, stations, and park-and-ride lots, as well as accommodations for transit vehicles accessing these facilities and traveling along the corridor. Commonly applied accommodations for users include sidewalks, crosswalks, pedestrian push-buttons, and signal heads. Examples of transit accommodations at bus stops include loading pads and pull-outs.

Guidance is provided in Sections 2.8.1 through 2.8.3 concerning where separate multimodal accommodations are typically applicable. Depending on the current and future modal split, land use context, and vehicular volumes and speeds, separate multimodal accommodations may not be warranted. Guidance where separate multimodal accommodations are typically not warranted is provided in Section 2.8.4.

2.8.1 Pedestrian Accommodations

Most trips begin or end with walking. Pedestrians choose to walk for convenience, personal health, or out of necessity. They often prefer greater separation from the roadway, require adequate time to cross roadways, and are the most vulnerable of all street users. In addition, pedestrians will often seek to minimize travel distance, choosing direct routes and shortcuts even when facilities are not provided. Walking trips are often combined with transit for traveling longer distances, making accessibility to transit stops and stations an important consideration. In urban areas, walking trips are often combined with private motor vehicle trips. In this case, people often park once and then walk between stores, restaurants, and other destinations.

When pedestrian facilities are state or federally funded, they shall be designed and built to accommodate persons with disabilities in accordance with the access standards required by the ADA to the maximum extent feasible or to the extent it is not structurally impracticable.

Pedestrian accommodations are typically applicable:

- In all urban areas and town centers
- Along corridors with pedestrian travel generators and destinations (i.e. residential neighborhoods, commercial areas, schools, public parks, transit stops and stations, etc.), or areas where such generators and destinations can be expected prior to the design year of the project
- Where there is evidence of pedestrian traffic (e.g., a worn path along roadside)
- Within close proximity of a school, college, university, or major public institution (e.g., hospital, major park, etc.)
- Where there is an occurrence of reported pedestrian crashes
- Where a need is identified by a local government, MPO, or regional commission through an adopted planning study or where existing or future land use indicates a need
- On all new and widened bridges when any of the criteria listed above are met

Please refer to the Chapter listed below for guidance for the design of pedestrian accommodations:

- 7.0 Pedestrian Facilities

2.8.2 Bicyclists Accommodations

Bicycling trips serve both utilitarian and recreational purposes. Utilitarian trips are trips that are a necessary part of a person's daily activity such as commuting to work, errands, or taking a child to school. Recreational trips are usually discretionary trips made for exercise and/or leisure.

More experienced and confident bicyclists will typically choose whichever roadway (or off-road facility) provides the most direct, safest, and comfortable travel to their destinations. Less experienced bicyclists will typically choose routes for comfort or scenery, feel more comfortable on lower-speed and lower-volume streets, and prefer separated or delineated bicycle facilities.

Bicyclist accommodations are typically applicable:

- If the project is on a designated (i.e., adopted) U.S., state, regional, or local bicycle route (TDOT's state highway bicycle route plan is located online at: <https://www.tn.gov/tdot/multimodal-transportation-resources/bicycle-and-pedestrian-program/bicycle-routes.html>)
- Where there is an existing bikeway along or linking to the end of the project alignment (e.g., shared lane, paved shoulder, bicycle lane, shared-use path, or cycle track)
- Along project alignments or within close proximity to bicycle travel generators and destinations (i.e. residential neighborhoods, commercial centers, schools, colleges, scenic byways, public parks, transit stops/stations, etc.)
- Within a 3-mile bicyclist catchment area of an existing fixed-route transit facility (i.e., stop, station, or park-and-ride lot). A catchment area is defined by a radial distance from a transit facility per Federal Transit Administration (FTA) guidelines - this includes crossing and intersecting streets.
- Where there is an occurrence of reported bicycle crashes
- Where a project will provide connectivity between two or more existing bikeways or connects to an existing bikeway
- On all new and widened bridges when any of the criteria listed above are met

Please refer to the Chapter listed below for guidance for the design of bicyclist accommodations:

- 6.0 *Bicycle Facilities*

2.8.3 Transit User Accommodations

Transit serves a vital transportation function by providing people with freedom of movement and access to employment, schools, community and recreational facilities, medical care, and shopping centers. Transit directly benefits those who choose this form of travel, as well as those who have no other choice or means of travel. Transit also benefits motor vehicle users by helping to reduce congestion on roadway networks.

A vital part of the success of a transit system depends on the availability of easy access to transit stations, stops, and park-and-ride facilities. Accordingly, transit user accommodations along and across streets served by transit (and on streets that lead to transit corridors) should provide convenient pedestrian access to and from these facilities. Users also commonly access transit by bicycle, car, and taxi, as well as other modes of transit.

Transit user accommodations are typically applicable:

- On corridors served by fixed-route transit (fixed route transit providers in Tennessee can be found online at: <https://www.tn.gov/tdot/multimodal-transportation-resources/office-of-public-transportation/public-transit-services1.html>)
- Within a ¼-mile pedestrian catchment area of an existing fixed-route transit facility (i.e., stop, station, or park-and-ride lot). A catchment area is defined by a radial distance from a transit facility per Federal Transit Administration (FTA) guidelines - this includes crossing and intersecting streets.
- Between transit stops/stations and local destinations. Midblock crosswalks should be considered at transit stops not located within ¼ mile of a signalized intersection.

Please refer to the Chapters listed below for guidance for the design of transit accommodations:

- 4.0 Roadway Design Elements (transit vehicles)
- 6.0 Bicycle Facilities (bicyclist users)
- 7.0 Pedestrian Facilities (pedestrian users)
- 8.0 Transit Accommodations (transit vehicles)

2.8.4 Exclusions for Pedestrian and Bicyclist Accommodations

Those areas not specifically listed in Sections 2.8.1 through 2.8.3 typically do not warrant separate multimodal accommodations. Therefore, areas such as high-speed controlled access highways would not warrant sidewalks. Other exclusions for separate multimodal accommodations include:

- Low-speed, low-volume residential streets where pedestrians and bicyclists can comfortably share the roadway with motor vehicles;
- Rural streets where shoulders suffice for the occasional pedestrian or bicyclist.
- On side road tie-ins where there is no existing sidewalk or bicycle accommodation and widening of construction limits for sidewalk or bicycle accommodation would result in disproportionate impacts to adjacent property;
- Sidewalks are not required in rural areas where curb and gutter is placed at the back of the useable shoulder solely for the purpose of reducing construction limits and/or meeting drainage/ storm sewer requirements.

2.9 SECTION 2.0 SOURCES

1. American Association of State Highway and Transportation Officials. (2011). *A Policy on Geometric Design of Highways and Streets*. Washington D.C.
2. City of Los Angeles, CA. (2015). *City of Los Angeles Complete Streets (Draft)*. Los Angeles, CA.
3. Federal Highway Administration. (2016). *Achieving Multimodal Networks, Applying Design Flexibility & Reducing Conflicts*. Washington, D.C.
4. Institute of Transportation Engineers. (2016). *Traffic Engineering Handbook, Seventh Edition*. Hoboken, NJ.
5. Massachusetts Highway Department. (2006). *Project Development and Design Guide*. Chapter 5. Boston, MA.
6. National Cooperative Highway Research Program. (2016). *Developing a Context-Sensitive Functional Classification System for More Flexibility in Geometric Design*. The National Academies of Sciences, Engineering, and Medicine, Washington, D.C.

[This page intentionally left blank]

3.0 SAFETY

Right-of-way and design constraints often pose challenges when retrofitting a multimodal design onto an existing street cross section. For low-volume and low-speed streets, many of the design modifications (narrow lanes, reduced lanes, adding sidewalks/walkways, adding bicycle lanes, etc.) are easy to make, requiring few trade-offs. Retrofitting multimodal street concepts on higher volume or higher speed streets is more challenging.

Speed is a primary consideration when evaluating potential adverse impacts of lane width on safety. On high-speed, rural two-lane highways, an increased risk of cross-centerline head-on or cross-centerline sideswipe crashes is a concern because drivers may have more difficulty staying within the travel lane. On any high-speed roadway, the primary safety concerns with reductions in lane width are crash types related to roadway departure.

In a low-speed urban environment, the effects of reduced lane width are different. On these facilities, the risk of roadway departure crashes is less. The design objective is often how to best distribute limited cross-sectional width to maximize safety for a wide variety of street users.

AASHTO Roadway Design Speed Classification

Low-speed is typically ≤ 45 mph

High-speed is typically ≥ 50 mph

Narrower lane widths may be chosen to manage or reduce speed and shorten crossing distances for pedestrians. Lane widths may be adjusted to incorporate other cross-sectional elements, such as medians for access control, bicycle lanes, on-street parking, transit stops, and landscaping.

3.1 HSM LIMITATIONS FOR MULTIMODAL SAFETY ANALYSIS

The *Highway Safety Manual* (HSM) is published by the American Association of State Highway and Transportation Officials (AASHTO) and provides information on transportation safety. The HSM provides methods for quantifying and predicting crash frequency and severity. The HSM is intended to assist agencies in their effort to integrate safety into their decision-making processes.

Unfortunately, the HSM is of limited use for urban multimodal safety analysis. It has limited data concerning low-speed urban streets and the safety of non-motorized users in general. Safety risks are subjective in many situations, and that is where engineering judgment must be utilized. Of primary importance on facilities that are reasonably expected to be utilized by pedestrians and bicyclists is the crash risk to these most vulnerable users of the street.

3.2 SAFETY VS. SPEED

Pedestrians and bicyclists are safer when motorists' speeds are lower (see Exhibit 3-1). Additionally, as vehicular speeds decrease, the cone of vision of drivers increases (see Exhibit 3-2), decreasing the possibility of a crash. This is not intended to promote all streets being designed for low-speed operations. It is intended to demonstrate the importance of accommodating all anticipated users and to take into account the street's land use context and functional classification, as discussed in Section 2.0 of this manual. The design of the street should be consistent with the level of multimodal activity generated by adjacent land uses to provide both mobility and a safer environment for all users. Additional information concerning engineering speed management countermeasures is provided in Section 4.3.4 *Engineering Speed Management Countermeasures*.

On higher speed roads, the speed differential between vehicles and bicyclists or pedestrians should be a major factor in determining multimodal facility selection along a corridor. The

likelihood of being killed or seriously injured increases exponentially with an increase in speed differential between motorized and non-motorized users, and between cyclists and pedestrians. Increased speed differential also presents additional challenges for all users for things such as pedestrians judging gaps between vehicles when crossing a road, or a motorist judging the distance required to pass a cyclist. Along corridors with large speed differentials between users, facilities separated by buffers or other physical elements for each user are recommended. Aside from safety, there is a direct correlation between speed differential and user comfort for all modes.

EXHIBIT 3-1: PEDESTRIAN SAFETY VS. VEHICLE SPEED

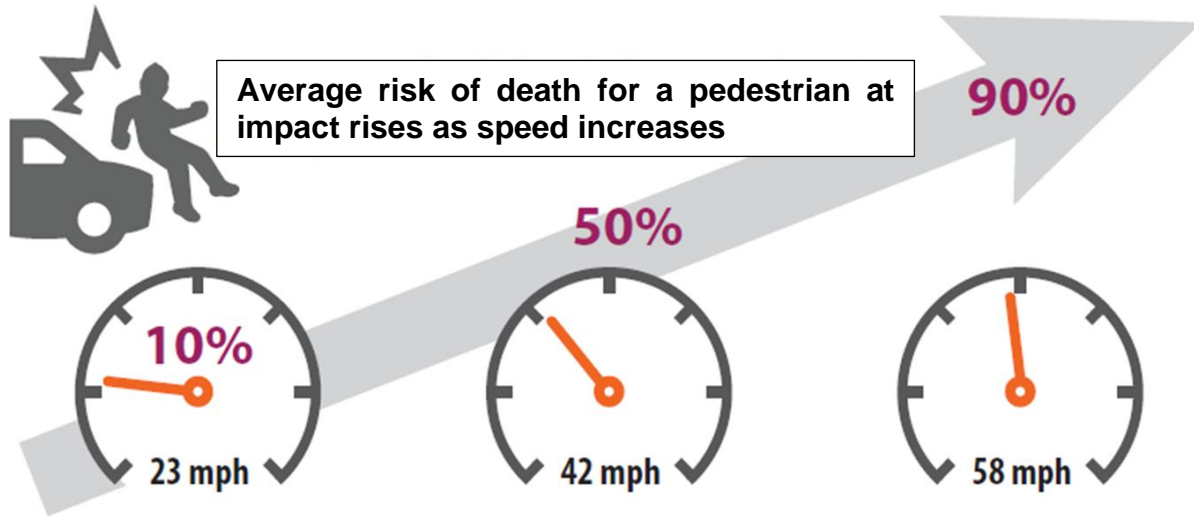

Source: FHWA Integrating Speed Management

EXHIBIT 3-2: DRIVER'S CONE OF VISION

A driver's visual focus diminishes as speed increases.



15 mph



20 mph



25 mph



30 mph

Source: NACTO Urban Street Design Guide

3.3 LANE WIDTH EFFECT ON SAFETY

3.3.1 Low-Speed Streets

The HSM safety performance functions for low-speed streets are not sensitive to lane width. The available research on the effects of narrow lanes on crashes on urban streets is mixed. In some cases, narrow lanes appear to have reduced crash rates. In other cases, narrow lanes appear to increase crashes. In other cases, a particular width has lower crash rates than wider or narrower widths. However, the potential for vehicle crash rates should be evaluated with the increased safety for vulnerable users in mind.

Recent research by Potts et al. under National Cooperative Highway Research Program (NCHRP) Project 03-72 and the Midwest Research Center found no statistical difference in safety performance for urban and suburban arterials with lane widths ranging from 10 to 12 feet and speeds less than 45 mph. However, lanes narrower than 12 feet may be a design concern on streets with substantial volumes of bicycles, trucks, and buses, especially on the outside travel lanes adjacent to the curb.

Lane Width Effect on Safety

There is no statistical difference in safety performance for urban and suburban arterials with lane widths ranging from 10 to 12 feet and speeds less than 45 mph.

There is a NCHRP project currently investigating the effects of narrow lanes on safety and operations of urban and suburban streets (NCHRP 03-112, *Operational and Safety Considerations in Making Lane Width Decisions on Urban and Suburban Arterials*), which may bring more clarity to the mixed results of previous studies.

3.3.2 High-Speed Roadways

For high-speed rural highways, the HSM has many useful Crash Modification Factors (CMFs). As shown in Exhibit 3-3 through Exhibit 3-5, nine-foot wide travel lanes on high-speed rural roadways have up to a 50 percent increase in crashes compared to 12-foot lanes. Ten-foot wide lanes have up to a 30 percent increase in crashes. The crash risk increases based on the facility type and traffic volumes.

EXHIBIT 3-3: CMF FOR LANE WIDTH ON HIGH-SPEED TWO-LANE ROADWAY SEGMENTS

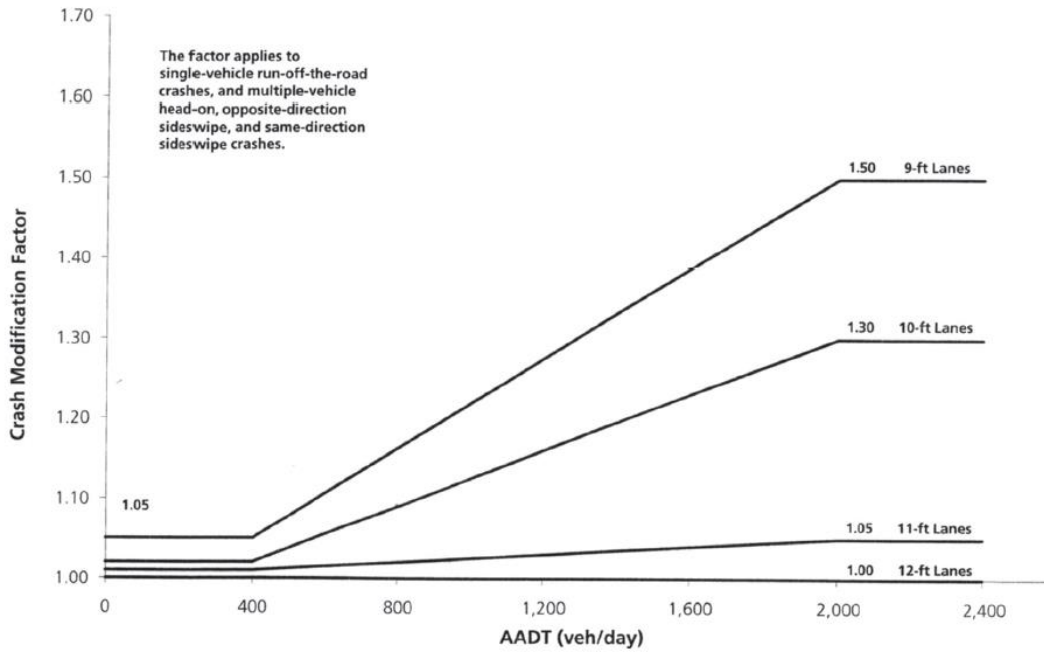

Source: HSM, NCHRP 783

EXHIBIT 3-4: CMF FOR LANE WIDTH ON HIGH-SPEED MULTILANE UNDIVIDED ROADWAY SEGMENTS

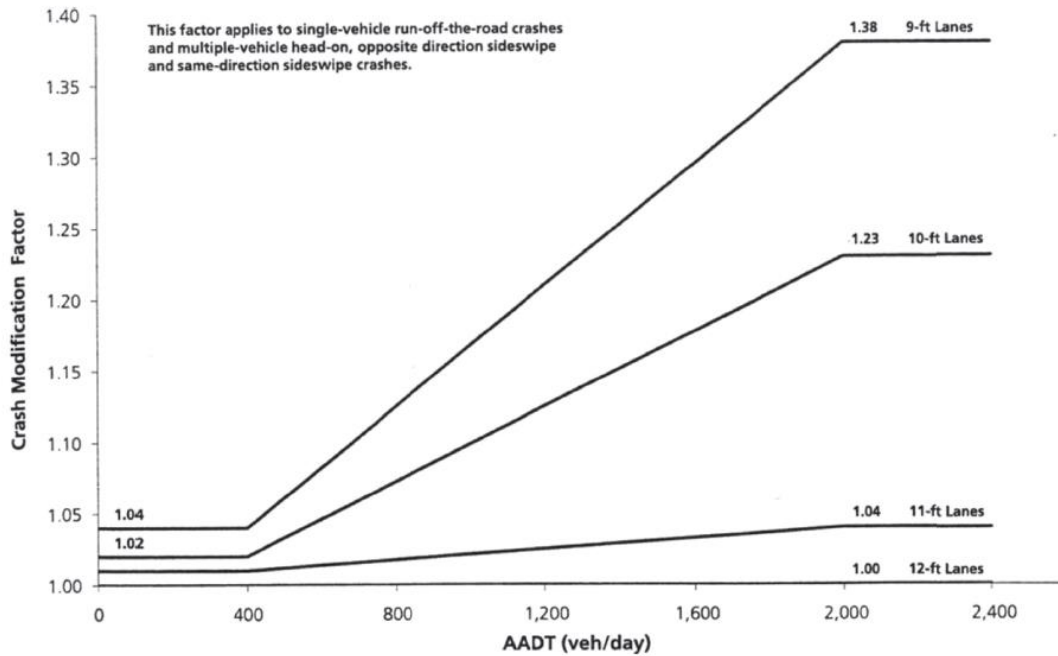

Source: HSM, NCHRP 783

EXHIBIT 3-5: CMF FOR LANE WIDTH ON HIGH-SPEED MULTILANE DIVIDED ROADWAY SEGMENTS

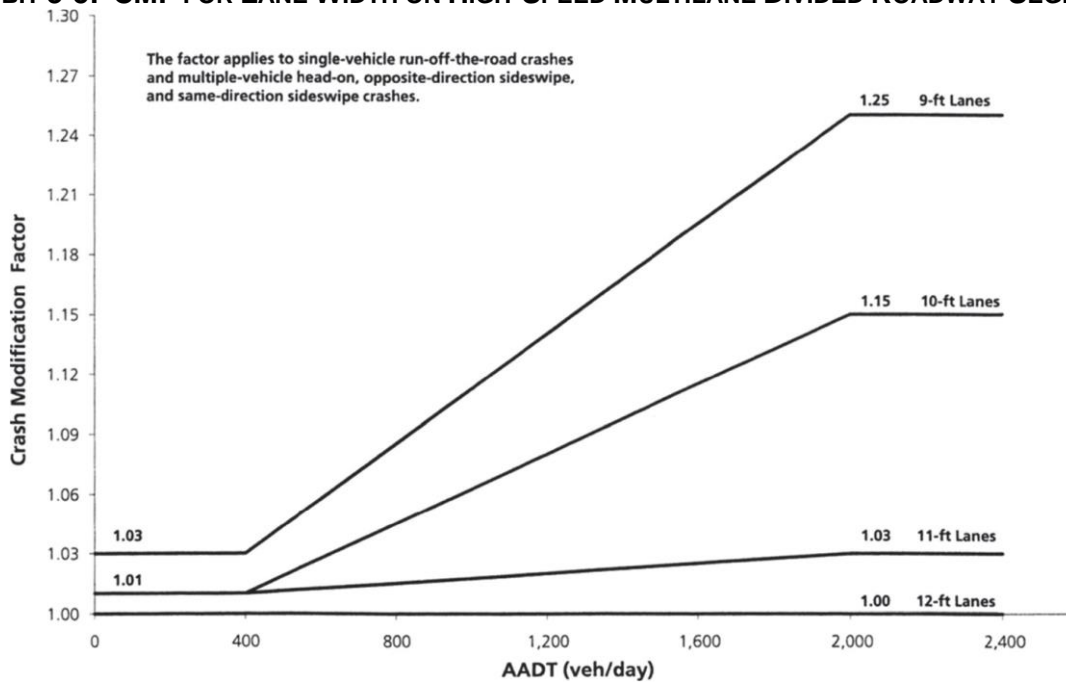

Source: HSM, NCHRP 783

3.4 SHOULDER WIDTH EFFECT ON SAFETY

3.4.1 Low-Speed Streets

There is no known research or safety performance functions for shoulder width on low-speed streets. As with lane width, the HSM does not provide a CMF for shoulder width on low-speed urban and suburban arterials.

3.4.2 High-Speed Roadways

Wider shoulders on high-speed roadways provide some refuge for the occasional pedestrian or bicyclist, as well as reducing run-off-the-road vehicle crash potential. For high-speed rural highways, the HSM has CMFs for shoulder widths. As seen in Exhibit 3-6, the lack of shoulders can increase vehicular crash risk up to 50 percent. As seen in Exhibit 3-6 and Exhibit 3-7, there is limited safety improvement for motorized vehicles with shoulders over six feet wide. Shoulders wider than six feet may provide additional safety for bicyclists and pedestrians.

EXHIBIT 3-6: CMF FOR SHOULDER WIDTH ON HIGH-SPEED TWO-LANE ROADWAY SEGMENTS

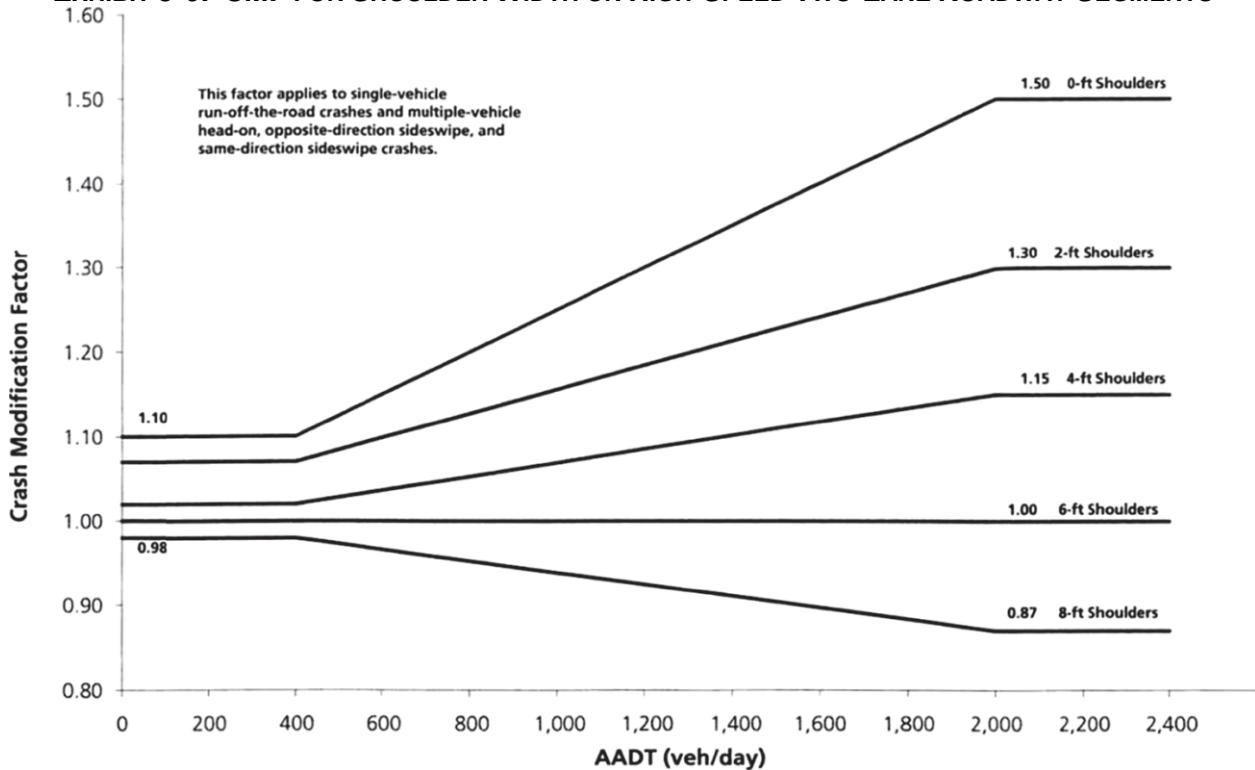

Source: HSM, NCHRP 783

EXHIBIT 3-7: CMF FOR SHOULDER WIDTH ON HIGH-SPEED MULTILANE-DIVIDED HIGHWAYS

Average paved shoulder width				
0 ft	2 ft	4 ft	6 ft	8 ft or more
1.18	1.13	1.09	1.04	1.00

Source: HSM, NCHRP 783

3.5 PEDESTRIAN PATH EFFECTS ON SAFETY

The presence of a sidewalk or pathway on both sides of a street corresponds to an 88% reduction in “walking along road” pedestrian crashes. Providing paved, widened shoulders (minimum of four feet) on roadways that do not have sidewalks corresponds to a 71% reduction in “walking along the road” pedestrian crashes¹.

3.6 SECTION 3.0 SOURCES

1. American Association of State Highway and Transportation Officials. (2010). *Highway Safety Manual*. Washington, D.C.
2. Federal Highway Administration. (2016). *Applying Performance-Based Practical Design Methods to Complete Streets: A Primer on Employing Performance-Based Practical Design and Transportation Systems Management and Operations to Enhance the Design of Complete Streets*. Washington, D.C.
3. Federal Highway Administration. (2012). *Bicycle Road Safety Audit Guidance and Prompt Lists*. Washington, D.C.
4. Federal Highway Administration. (2008). *Guidance Memorandum on Consideration and Implementation of Proven Safety Countermeasures*. Washington, D.C.
5. Federal Highway Administration. (2016). *Integrating Speed Management within Roadway Departure, Intersections, and Pedestrian and Bicyclist Safety Focus Areas*. Washington, D.C.
6. Institute of Transportation Engineers. (2016). *Traffic Engineering Handbook, Seventh Edition*. Hoboken, NJ.
7. National Association of City Transportation Officials. (2012). *Urban Street Design Guide*. New York, NY.
8. National Cooperative Highway Research Program. (2014). *Evaluation of the 13 Controlling Criteria for Geometric Design (Report 783)*. The National Academies of Sciences, Engineering, and Medicine, Washington, D.C.
9. Potts, I. B., D. W. Harwood, D. J. Torbic, K. M. Bauer, K. R. Richard, D. K. Gilmore, D. K. Lay, J. F. Ringert, J. D. Zegeer, D. L. Harkey, and J. M. Barlow, “Lane Widths, Channelized Right Turns, and Right-Turn Deceleration Lanes on Urban and Suburban Arterials,” Final Report of NCHRP Project 03-72, Midwest Research Institute, August 2006.
10. Potts, I. B., D. W. Harwood, and K. R. Richard, “Relationship of Lane Width to Safety on Urban and Suburban Arterials,” *Transportation Research Record: Journal of the Transportation Research Board*, No. 2023, Transportation Research Board of the National Academies, Washington, D.C., 2007, pp. 63–82.

¹ <https://safety.fhwa.dot.gov/legislationandpolicy/policy/memo071008/>

4.0 ROADWAY DESIGN ELEMENTS

AASHTO's *A Policy on Geometric Design of Highways and Streets* (Green Book) makes a distinction between design criteria for high-speed facilities and low-speed facilities. The boundary between high-speed design and low-speed design is in the range of 45 to 50 mph. The lower limit for high-speed design is 50 mph, and the upper limit for low-speed design is 45 mph. These speeds correspond to the design speed of the facility, and not the posted speed. The Green Book emphasizes the need for a holistic design approach and the use of engineering judgment, and highlights how the guidelines allow for flexibility, particularly for low-speed roadways.

AASHTO Roadway Design Speed Classification

Low-speed is typically ≤ 45 mph

High-speed is typically ≥ 50 mph.

The selected Design Vehicle, design speed, and other design criteria affect the design of a roadway and the speeds at which motorists will feel comfortable driving. The speeds at which motorists operate has a direct effect on the safety and comfort of pedestrians, bicyclists, and transit users. For a street to have an effective multimodal design, the selected design criteria and roadway design elements must complement the adjacent land use context and desired multimodal activity.

4.1 DESIGN VEHICLES VS. CONTROL VEHICLES

The Design Vehicle influences the selection of design criteria related to turning radii such as curb-return radii and lane width. It is not always practical or desirable to choose the largest Design Vehicle that might occasionally use a roadway, because the larger turning radius negatively impacts pedestrian crossing distances, crosswalk design, speed of turning vehicles/pedestrian safety, right-of-way, etc. and may be inconsistent with the adjacent land use context and multimodal objectives for the street. In contrast, selection of a smaller Design Vehicle in the design of a facility regularly used by large vehicles will create frequent operational problems. The roadway should be designed for the largest Design Vehicle that will use the facility with considerable frequency (for example, a bus on bus routes, a semi-tractor trailer on primary freight routes), but not the largest vehicle that might occasionally be present. In urban environments, the largest frequent users of roadways are often buses (on bus routes) and package delivery trucks on non-bus routes. Fixed route transit providers in Tennessee can be found online at: <https://www.tn.gov/tdot/multimodal-transportation-resources/office-of-public-transportation/public-transit-services1.html>.

Two types of vehicles should be considered when designing a roadway, the Design Vehicle and the Control Vehicle (see Exhibit 4-1).

The Design Vehicle must be regularly accommodated without encroachment into the opposing traffic lanes. A condition that uses the Design Vehicle concept arises when large vehicles regularly turn at an intersection with high volumes of opposing traffic (such as a bus route).

The Control Vehicle is an infrequent user of a facility that must be accommodated, but encroachment into the opposing traffic lanes, multiple-point turns, or minor encroachment into the streetside is acceptable. A condition that uses the Control Vehicle concept arises when occasional large vehicles turn at an intersection with low opposing traffic volumes (such as a moving van in a residential neighborhood or once-per-week delivery at a business) or when large vehicles rarely turn at an intersection with moderate to high opposing traffic volumes (such as emergency vehicles).

EXHIBIT 4-1: DESIGN VEHICLE VS. CONTROL VEHICLE TURNING MOVEMENT PATH

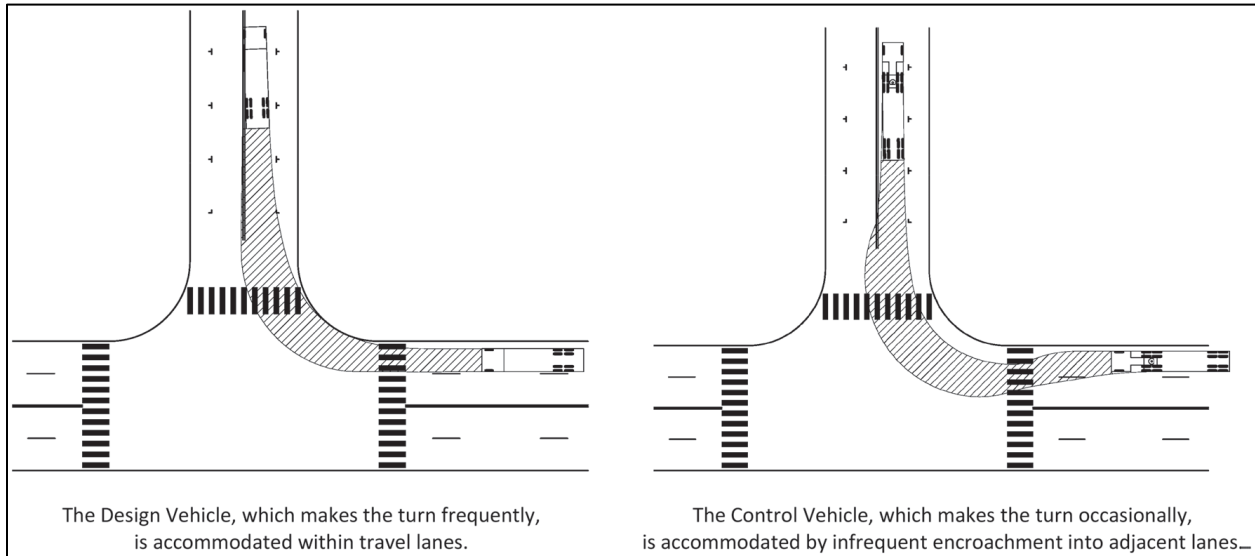

Source: ITE Traffic Engineering Handbook/Portland DOT/Whitman, Requardt & Associates, LLP.

4.2 CURB RADII

The curb radii used at both signalized and unsignalized intersections should be selected based on safety, operations, and convenience for pedestrians, bicyclists, and motor vehicles. Curb radii should be appropriate for the largest Design Vehicle that regularly makes a specific turning movement. Due to constraints of adjacent development and pedestrian/bicyclist considerations in urban areas, it is usually not practical to provide the full curb radii that would be necessary for the occasional Control Vehicle.

Larger intersection curb radii have disadvantages for pedestrians and bicyclists because they can increase pedestrian crossing distance and the speeds of turning vehicles, creating increased safety risks. Large radii also move pedestrians out of the driver's line of sight and make it more difficult for pedestrians to see approaching vehicles, and vice-versa.

Smaller curb radii allow for shorter pedestrian and bicyclist crossing distances, which reduces exposure to moving vehicles, decreases walk time, and increases signal efficiency. The trade-off is the infrequent Control Vehicle may need to encroach into the opposing traffic lanes, make multiple-point turns, have minor encroachment into the streetside to make the turn (see Exhibit 4-1), or take a different route. The designer must ensure that infrastructure such as signal poles, signal cabinets, light poles, street furniture, etc. does not conflict with the Control Vehicle if areas outside the designated turn/travel lanes will be utilized. Additionally, on-street parking and bicycle lanes shall be taken into account when designing a curb radius, as they will increase a vehicle's effective turning radius, allowing the curb radius to be smaller (see Exhibit 4-2).

EXHIBIT 4-2: TURNING RADIUS VS. CURB RADIUS

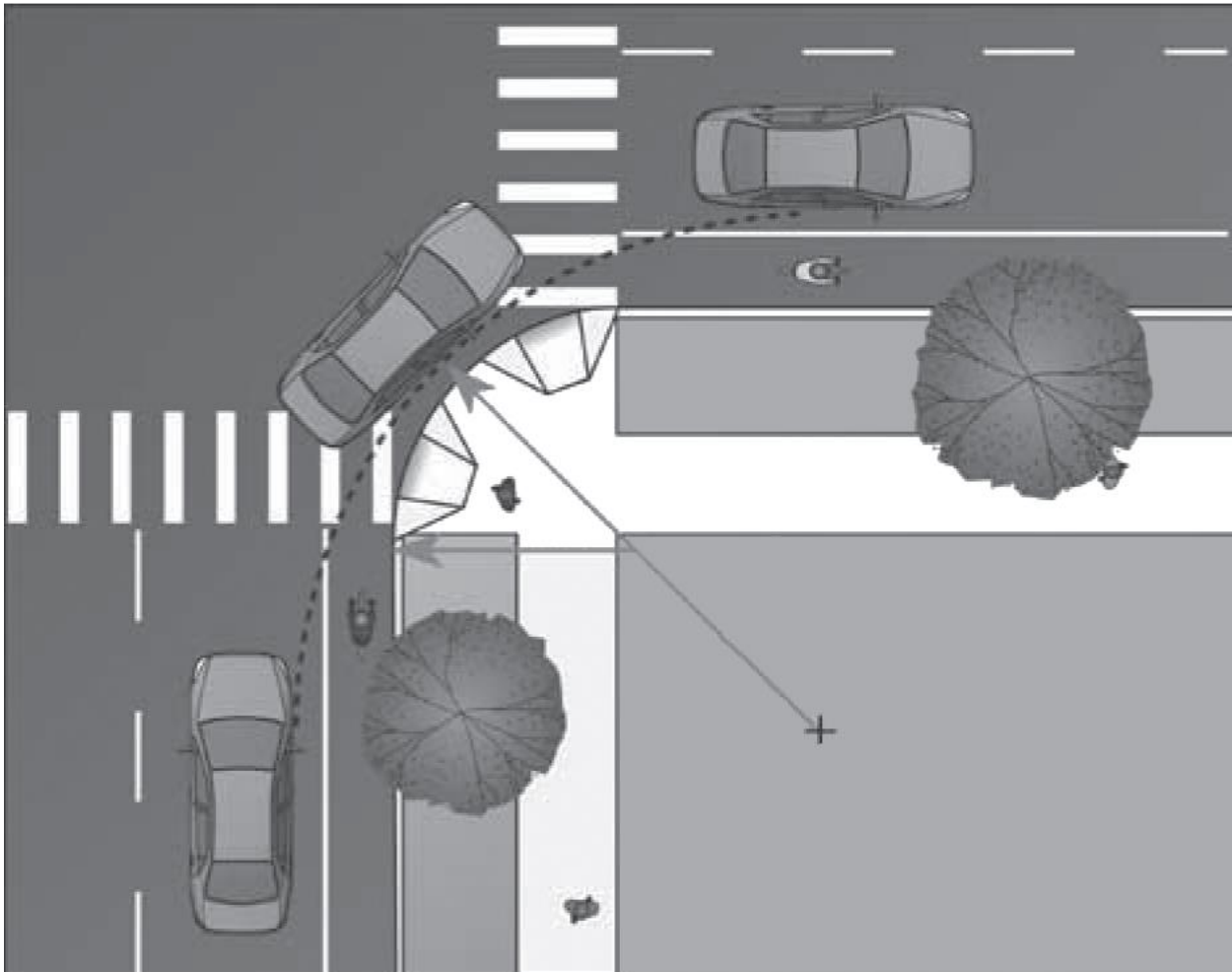

Source: ITE/Congress for the New Urbanism

At intersections of roadways where trucks make frequent right turns, a raised channelization island between the through lanes and the right-turn lane may be a better alternative than an overly large corner radius. If designed correctly, a raised island can achieve the following:

- Allow pedestrians to cross fewer lanes at a time
- Allow motorists and pedestrians to judge the right turn/pedestrian conflict separately
- Reduce pedestrian crossing distance, which can improve signal timing for all users
- Balance vehicle capacity and truck turning needs with pedestrian safety
- Provide an opportunity for landscape and hardscape enhancement

The following design practices for right-turn lane channelization islands should be used to provide safety and convenience for pedestrians, bicyclists, and motorists:

- The provision of a channelized right-turn lane is appropriate on signalized approaches where right-turning volumes are high or large vehicles frequently turn and conflicting pedestrian volumes are low.
- Provide a yield sign for the channelized right-turn lane unless a continuous receiving lane is provided.
- Tighter angles are preferred.
- Provide at least a 60-degree angle between vehicle flows, which reduces turning speeds and improves the yielding driver's visibility of pedestrians and vehicles.
- Place the crosswalk across the right-turn lane about one car length back from where drivers yield to traffic on the other street, allowing the yielding driver to respond to a potential pedestrian conflict first, independently of the vehicle conflict, and then move forward, with no more pedestrian conflict.
- Provide raised, ADA compliant, islands for pedestrian refuge.
- Curbed channelization islands must include curb ramps or at-grade cut-through paths for pedestrians. At-grade cut-through paths should be at least five feet wide to provide room for two users of wheelchairs to pass in opposite directions. Cut-through paths should be designed to allow for water to drain from the island area to the travel lanes. Detectable warnings are required at the transition between cut-through paths and vehicular travel ways (assuming the island is at least six feet wide).
- Unless the turning radii of trucks or buses need to be accommodated, the pavement of the channelized right-turn lane should be no wider than 16 feet; and to slow vehicles, the width of the travel lane should be restricted to 12 feet by marking the edge lines and using cross-hatching based on engineering judgment.
- Signalization of the channelized right-turn lane can reduce vehicle-pedestrian conflicts and may be appropriate where: (1) there are multiple right-turn lanes, (2) crash data show a high frequency of vehicle-pedestrian crashes, or (3) there are other concerns such as restricted sight distance or vehicle speeds are high on the turning roadway.

The preferred channelized right-turn island design is roughly twice as long as it is wide. The corner radius will typically have a long radius (150 feet to 300 feet) followed by a short radius (20 feet to 50 feet). When creating this design, it is often necessary to allow large trucks to turn into multiple receiving lanes or the opposing lane. This design is therefore often not practical for right-turn lanes onto roads with only one through lane.

EXHIBIT 4-3: PREFERRED CHANNELIZED ISLAND DESIGN

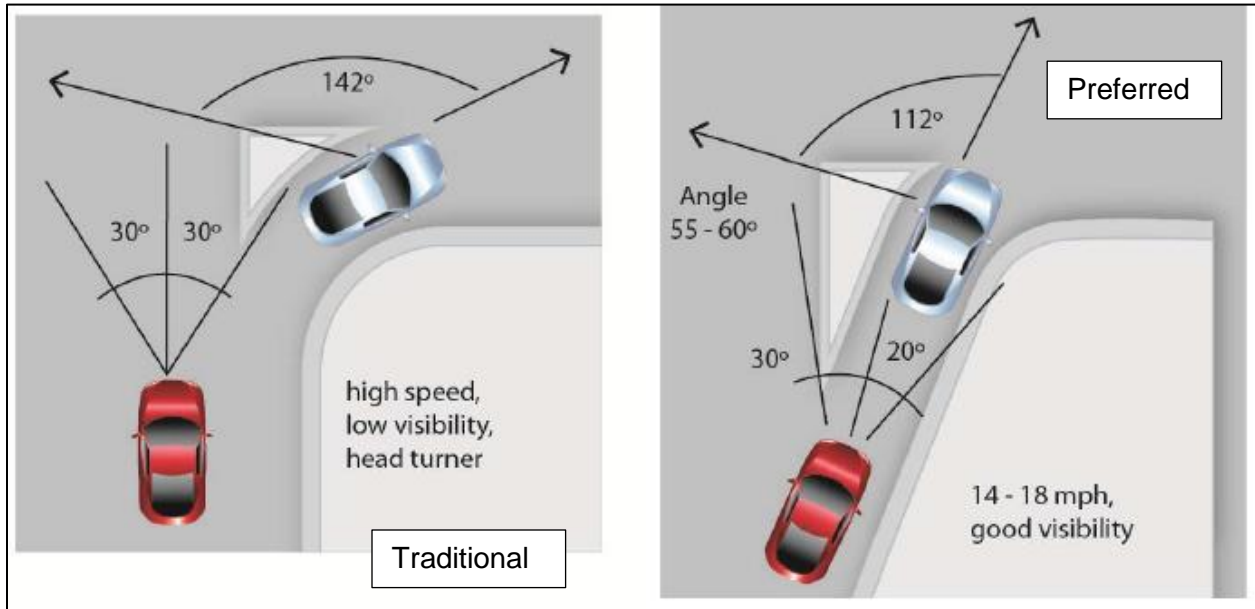

Source: Broward County, FL Complete Streets Guidelines

4.3 SPEED

The following sections describe various concepts associated with speed, including operating, posted, running, design, and target speeds. Also described are measures to obtain desired target speeds and design recommendations to transition from high-speed rural operations to low-speed urban ones.

In 2015, FHWA posted a memorandum that clarified the relationship between design speed and posted speed. This memo noted that posted speeds should be established based on statutory limits unless an engineering study has been performed in accordance with established traffic engineering practices. It also noted that variable speed limits may be appropriate in some locations, allowing for adjustments to be made under changing weather or traffic conditions. It also specifically noted that in urban areas, “the design of the street should generally be such that it limits the maximum speed at which drivers can operate comfortably, as needed to balance the needs of all users.”

4.3.1 Operating, Posted, and Running Speed

Operating speed is the speed at which drivers are observed operating their vehicles during free-flow conditions. The 85th percentile of the distribution of observed speeds is the most frequently used measure of the operating speed associated with a particular location or geometric feature, and the traditional basis of the posted speed limit.

The speed that an individual vehicle travels over a highway section is known as its running speed. The running speed is the length of the roadway section divided by the running time for the vehicle to travel through the section. The average running speed on a given highway varies during the day, depending primarily on the traffic volume.

4.3.2 Design Speed

Design speed influences other design criteria such as horizontal and vertical alignment, lane width, shoulder width, grade, and stopping sight distance. The selected design speed should be a logical one with respect to the anticipated operating speed, topography, the adjacent land use, and the functional classification of the highway. The AASHTO Green Book makes a distinction between design criteria for high-speed facilities and low-speed facilities. The boundary between high-speed design and low-speed design is in the range of 45 to 50 mph (design speed). On rural, high-speed roadways (50 mph design speed and above), above minimum design criteria for specific design elements should be used, where practical. On lower speed facilities (45 mph design speed and below), use of above-minimum design criteria may encourage travel at speeds higher than the appropriate speed for the land use context.

AASHTO Roadway Design Speed Classification

Low-speed is typically \leq 45 mph
 High-speed is typically \geq 50 mph.

Urban arterial roadways generally have running speeds of 20 to 45 mph. The traditional design speed approach would propose appropriate design speeds of 30 to 60 mph. However, this may contribute to undesirably high travel speeds. As a result, a new concept called target speed has been developed (see Section 4.3.3). Regardless of whether called “design speed” or “target speed”, urban roadways should have design elements that promote safer operating speeds consistent with the context of the project area.

4.3.3 Target Speed

Target speed is a relatively new concept that applies to urban and suburban environments; it is not applicable to high-speed rural roadways. Its basis is that the current practice of creating a forgiving roadway increases operating speed, creating a more dangerous street for all users including motorists, pedestrians, and bicyclists. Target speed reverses the use of operating speed in design. Instead of designing to current and sometimes undesirably high operating speeds, it promotes constraining operating speeds through design.

Target speed is the highest speed at which vehicles should operate on a street in a specific context, consistent with the level of multimodal activity generated by adjacent land uses to provide both mobility for motor vehicles and a safer environment for pedestrians and bicyclists. The target speed is designed to become the posted speed limit. Target speeds in urban environments are lower than traditional design speeds, often as low as 20 mph.

4.3.4 Engineering Speed Management Countermeasures

Posting streets for lower speeds is generally insufficient to influence driver behavior. The design of the street and its surrounding land use context provide strong cues to the driver as to the appropriate travel speed. This is why selecting the appropriate design/target speeds is so important for urban roadways. Narrower lane widths, on-street parking, curbing, landscaping, and restrictive horizontal and vertical alignments help reduce motorists’ speeds. Additional design elements for consideration are provided in Exhibit 4-4.

EXHIBIT 4-4: SPEED REDUCTION FEATURES

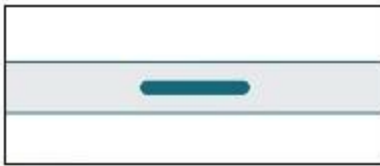

Median
Medians create a pinchpoint for traffic in the center of the roadway and can reduce pedestrian crossing distances.

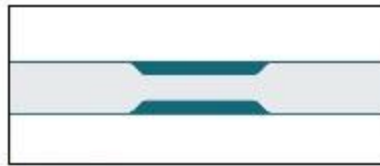

Pinchpoint
Chokers or **pinchpoints** restrict motorists from operating at high speeds on local streets and significantly expand the sidewalk realm for pedestrians.

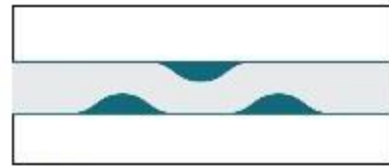

Chicane
Chicanes slow drivers by alternating parking or curb extensions along the corridor.

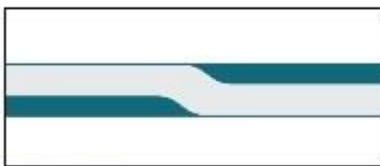

Lane Shift
A lane shift horizontally deflects a vehicle and may be designed with striping, curb extensions, or parking.

See **Chicane**

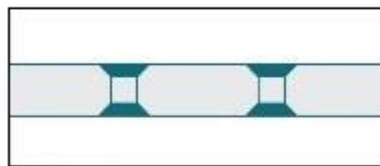

Speed Hump
Speed humps vertically deflect vehicles and may be combined with a midblock crosswalk.

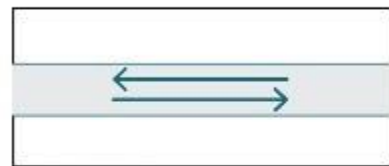

2-Way Street
2-way streets, especially those with narrower profiles, encourage motorists to be more cautious and wary of oncoming traffic.

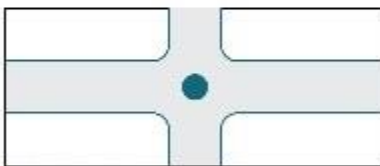

Roundabout
Roundabouts reduce traffic speeds at intersections by requiring motorists to move with caution through conflict points.



Diverter
A traffic diverter breaks up the street grid while maintaining permeability for pedestrians and bicyclists.

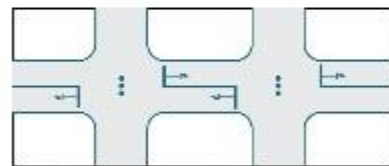

Signal Progression
Signals timed to a street's target speed can create lower speeds along a corridor.



Building Lines
A dense built environment with no significant setbacks constrains sightlines, making drivers more alert and aware of their surroundings.

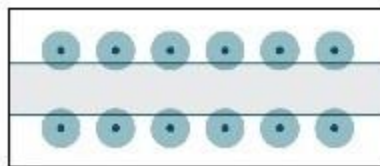

Street Trees
Trees narrow a driver's visual field and create rhythm along the street.

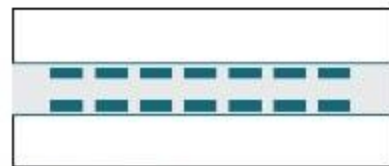

On-Street Parking
On-street parking narrows the street and slows traffic by creating friction for moving vehicles.

Source: NACTO Speed Reduction Mechanisms

FHWA has developed a desktop reference of potential effectiveness in reducing crashes. The reference provides categories of improvement, its safety focus (i.e. pedestrians, roadway departure, and intersection), the appropriate land use context for implementation, and the predicted crash reduction percentage. The *Engineering Speed Management Countermeasures: A Desktop Reference of Potential Effectiveness in Reducing Crashes* can be viewed at: http://safety.fhwa.dot.gov/speedmgt/ref_mats/eng_count/2014/reducing_crashes.cfm.

An additional resource for engineering speed countermeasures is FHWA's *Integrating Speed Management within Roadway Departure, Intersections, and Pedestrian and Bicyclist Safety Focus Areas*. Of particular interest is Section 4.3 of this report, *Pedestrians/Bicyclists and Speed Management*. Several countermeasures to improve the safety of pedestrians and bicyclists are listed, including:

- Roadway lighting
- Pedestrian hybrid beacons (i.e. High intensity Activated crossWalk/HAWK)
- In-roadway warning lights
- Raised median or refuge islands
- Road Diets

4.3.5 Transition Zones

The AASHTO Green Book makes a distinction between design criteria for high-speed facilities and low-speed facilities. The boundary between high-speed design and low-speed design is in the range of 45 to 50 mph. These speeds correspond to design speed, and not the posted speed limits. Where high-speed facilities meet low-speed facilities, there is a transition zone where drivers in one direction are expected to reduce their speed to one suitable for the environment they are entering. An example of this is where a high-speed rural two-lane highway (e.g., with a posted speed limit of 55 mph) enters a community or other developed area. Through the community, higher speeds are not appropriate for a number of potential reasons that include turning maneuvers at intersections and driveways, higher development density, on-street parking, higher pedestrian and bicycle activity levels, and use of curb and gutter cross sections.

The AASHTO Green Book provides flexibility regarding the design of the transition zone into a lower-speed environment stating that the introduction of a lower design speed should not be done abruptly but should be effected over sufficient distance to permit drivers to gradually change speed before reaching the lower design speed section. The highway features within this transition zone, such as curvature, superelevation, lane and shoulder widths, and roadside clearances should be designed to encourage slower speeds. Pavement markings, such as painted center islands, painted narrower lanes, on-pavement speed limit markings, or on-pavement SLOW markings, are not recommended as standalone treatments as they have been shown to either not be effective or only marginally effective at influencing motorist speeds.

The two areas that make up the transition zone include the perception-reaction area and the deceleration area (see Exhibit 4-5).

EXHIBIT 4-5: TRANSITION ZONE AREAS

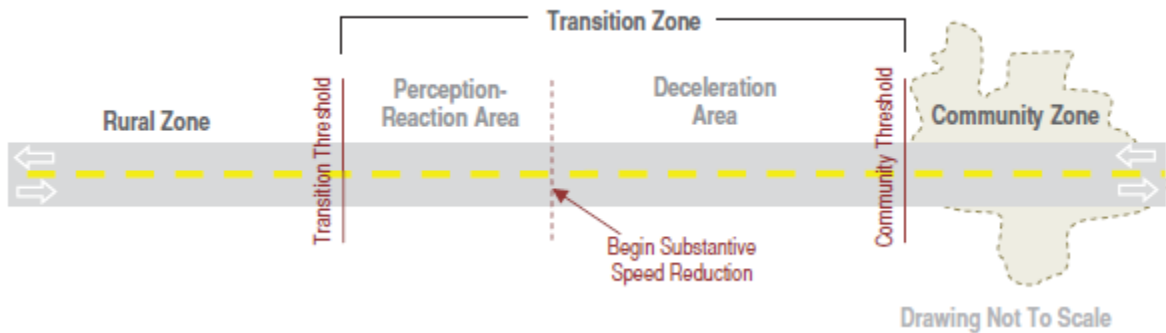

Source: NCHRP 737 Figure 4-1.

The perception-reaction area is the portion of the transition zone where drivers are made aware of an impending need to change their speed and driving behavior. The general physical and operational characteristics of this area are similar to the rural zone; however, some elements should begin to change. Drivers in this area should have clear lines of sight to signs as well as other warning and/or psychological devices that alert them to the changes ahead. These devices may be physically located in either the perception-reaction area and/or the deceleration area, depending on the device and design criteria. Some deceleration may occur in this area, but the primary objective is to mentally prepare drivers to adjust their driving behavior and speeds in the deceleration area.

The deceleration area is the portion of the transition zone where the driver is expected to decelerate to a safer operating speed for entering the developed area. Driver awareness and behavior should adjust with the change in the driving environment. The roadway and roadside characteristics as well as the land use and access are generally beginning to change in this area. The deceleration area may include physical measures to reinforce the needed speed transition. The length of the deceleration area is determined by factors such as the design speed profile, lines of sight, and design criteria for any physical features introduced in this area. The boundary between this area and the community zone should be set based on safety, roadway, traffic operations, and land-use criteria.

NCHRP 737 *Design Guidance for High-Speed to Low-Speed Transition Zones for Rural Highways* provides several measures, along with their predicted effectiveness, to lower speeds in transition zones. These measures are shown in Exhibit 4-6 through Exhibit 4-13.

EXHIBIT 4-6: SPEED REDUCTION TREATMENT; CENTER ISLAND/RAISED MEDIAN

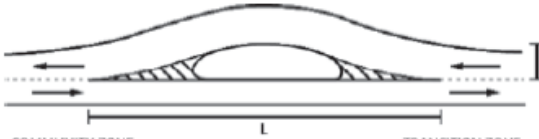
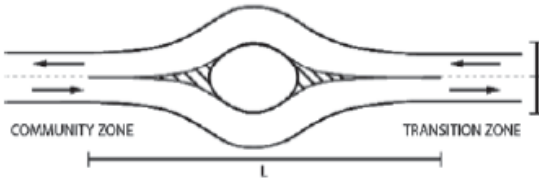
<p>Treatment: Center island/raised median</p>	<p>Category: Geometric Design</p>	
<p>Description: A channelizing island that creates separation between the two opposing directions of travel. Center islands/raised medians can create shifts or deflections in the travel paths of vehicles and often reduce the effective widths of the roadways. Center islands/raised medians can be created through a combination of pavement markings, raised curbs, planting strips, etc.</p>		
<p>Effectiveness: Berger and Linauer (1998) developed speed prediction models for center islands. The models can be used to calculate the mean and 85th percentile speeds as vehicles travel past the island. ★★</p> <p>$V_{85} = 9.194 \ln(L/2d) + 12.290$ $V_m = 8.020 \ln(L/2d) + 11.031$</p> <p>where: V_{85} = 85th percentile speed (mph) V_m = mean speed (mph) L = length of island + length of both tapers (ft) d = lateral deflection of lane (ft)</p> <p>In general, installation of a center island or raised median could be expected to reduce mean speeds by 3 to 10 mph and 85th percentile speeds by 5 to 10 mph (Dixon et al., 2008). ★</p>	 <p style="text-align: right;">2012.044R.1</p>	
<p>Cost: Moderate to high for raised center islands. Low for painted islands. The need to acquire right of way will increase the cost.</p>	<p>Contraindications: A raised center island may increase the potential for single-vehicle crashes.</p>	<p>Installation Location: Downstream end of deceleration area within the transition zone and/or in conjunction with a gateway treatment.</p>

Source: NCHRP 737 Design Guidance for High-Speed to Low-Speed Transition Zones for Rural Highways

EXHIBIT 4-7: SPEED REDUCTION TREATMENT; ROUNDABOUT

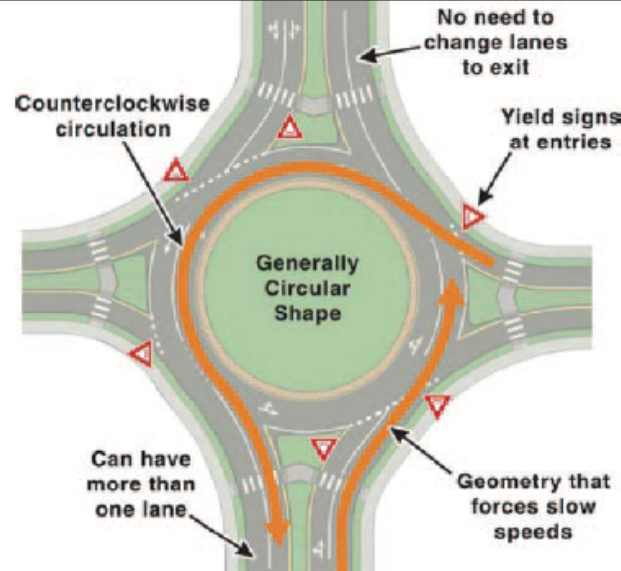
<p>Treatment: Roundabout</p> <p>Description: A roundabout is a form of circular intersection in which traffic travels counterclockwise (in the United States and other right-hand traffic countries) around a central island. Entering traffic must yield to circulating traffic. The channelized approaches and geometry induce reduced travel speeds through the circular roadway.</p>	<p>Category: Geometric Design</p>  <p style="text-align: center;">Source: Rodegerdts et al., 2010</p>												
<p>Effectiveness: Rodegerdts et al. (2007, 2010) developed prediction models for estimating entry and exit speeds for roundabouts: ★★★</p> $V_{\text{exit}} = \text{MIN} \left(aR_3^b; \frac{1}{1.47} \sqrt{(1.47aR_2^b)^2 + 13.8d_3} \right) \qquad V_{\text{enter}} = \text{MIN} \left(aR_1^b; \frac{1}{1.47} \sqrt{(1.47aR_2^b)^2 + 8.4d_1} \right)$ <p>where: V_{exit} = predicted exit speed (mph) V_{enter} = predicted entry speed (mph) d_1 = distance between point of interest on the entry and midpoint of path on circulating roadway (ft) d_2 = distance between point of interest on the entry and the midpoint of path on the circulating roadway (ft) d_3 = distance between the midpoint of path on the circulating roadway and point of interest on the exit (ft) R_1 = path radius on entry to roundabout (ft) R_2 = path radius on circulating roadway (ft) R_3 = path radius on exit from roundabout (ft) a, b = regression parameters</p> <table border="1" style="margin-left: auto; margin-right: auto; border-collapse: collapse; text-align: center;"> <thead> <tr> <th colspan="3">Speed Prediction Parameters</th> </tr> <tr> <th></th> <th>Superelevation +0.02</th> <th>Superelevation -0.02</th> </tr> </thead> <tbody> <tr> <td>a</td> <td>3.4415</td> <td>3.4614</td> </tr> <tr> <td>b</td> <td>0.3861</td> <td>0.3673</td> </tr> </tbody> </table>		Speed Prediction Parameters				Superelevation +0.02	Superelevation -0.02	a	3.4415	3.4614	b	0.3861	0.3673
Speed Prediction Parameters													
	Superelevation +0.02	Superelevation -0.02											
a	3.4415	3.4614											
b	0.3861	0.3673											
<p>Roundabouts increase the rate of compliance of vehicles traveling at or below the speed limit at the end of a transition zone by 15% compared to no treatment and increase the rate of compliance of vehicles traveling at or below the speed limit + 5 mph at the end of a transition zone by 11% compared to no treatment. ★★★</p> <p>Converting a two-way stop-controlled intersection to a roundabout reduces total crashes by 71% and fatal and all injury crashes by 87% (AASHTO, 2010). ★★★</p> <p>Converting a signalized intersection to a roundabout reduces total crashes by 48% and fatal and all injury crashes by 78% (AASHTO, 2010). ★★★</p>													
<p>Cost: High.</p>	<p>Contraindications: A roundabout can be challenging for visually impaired pedestrians to navigate.</p>												
<p>Installation Location: Downstream end of deceleration area within the transition zone.</p>													

Source: NCHRP 737 Design Guidance for High-Speed to Low-Speed Transition Zones for Rural Highways

EXHIBIT 4-8: SPEED REDUCTION TREATMENT; ROADWAY NARROWING

Treatment: Roadway narrowing		Category: Geometric Design	
<p>Description: Roadway narrowing can be achieved either by physically reducing the roadway width or by narrowing the widths of the travel lanes. This technique is often installed in conjunction with adding bicycle lanes or adding a raised median.</p>			
<p>Effectiveness: Roadway narrowing strategies can be expected to reduce mean speeds by about 2 to 3 mph (Ewing, 2001). ★★</p>			
<p>Cost: Low to moderate costs depending upon whether the treatment is implemented by modifying pavement markings or physical changes to the roadway.</p>	<p>Contraindications: Narrower lanes could negatively impact large trucks, agricultural vehicles, and emergency response vehicles.</p>	<p>Installation Location: Narrower lanes could potentially be implemented throughout the full length of a transition zone, but more than likely would be implemented within the deceleration area.</p>	

Source: NCHRP 737 Design Guidance for High-Speed to Low-Speed Transition Zones for Rural Highways

EXHIBIT 4-9: SPEED REDUCTION TREATMENT; ROAD DIET

Treatment: Road diet		Category: Geometric Design	
<p>Description: A reduction in the number of through lanes (e.g., converting a four-lane road to a three-lane roadway with a two-way left-turn lane or converting a four-lane roadway to a two-lane roadway with a raised median or on-street parking.) Bicycle lanes are often installed in conjunction with road diets.</p>			
<p>Effectiveness: A road diet could be expected to reduce operating speeds by up to 5 mph with up to a 70% reduction in excessive speeding (Knapp and Rosales, 2007). ★★</p>			
<p>Cost: Medium to High.</p>	<p>Contraindications: A road diet may reduce the capacity of a facility depending upon the number and types of turns, the presence of heavy vehicles, and the number and frequency of transit stops.</p>	<p>Installation Location: A road diet could be implemented at the beginning of the transition zone and extend into and/or through the community. It is also possible that a road diet may begin downstream of a gateway, within the community.</p>	

Source: NCHRP 737 Design Guidance for High-Speed to Low-Speed Transition Zones for Rural Highways

EXHIBIT 4-10: SPEED REDUCTION TREATMENT; TRANSVERSE PAVEMENT MARKINGS

Treatment: Transverse pavement markings		Category: Traffic control devices	
<p>Description: Pavement markings placed perpendicular to the direction of travel to draw attention to a change in the roadway environment. The markings are placed in a pattern of progressively reduced spacing to give drivers the impression that their speed is increasing. Section 3B.22 of the MUTCD provides guidance for the application of speed reduction markings. In several cases, agencies have installed the pavement markings across a good portion of the travel lane, and in some cases have used a chevron pattern.</p>			
<p>Effectiveness: Transverse pavement markings increase the rate of compliance of vehicles traveling at or below the speed limit at the end of a transition zone by 20% compared to no treatment. ★★★</p>			
<p>Cost: Low.</p>	<p>Contraindications: Depending upon where the pavement markings are placed relative to the wheel paths of vehicles, maintenance costs may increase.</p>	<p>Installation Location: Transverse pavement markings could potentially be implemented anywhere within the transition zone, but more than likely should be implemented within the perception-reaction area.</p>	

Source: NCHRP 737 Design Guidance for High-Speed to Low-Speed Transition Zones for Rural Highways

EXHIBIT 4-11: SPEED REDUCTION TREATMENT; RUMBLE STRIPS

Treatment: Rumble strips		Category: Surface treatment	
<p>Description: Rumble strips are placed in the travel lanes perpendicular to the direction of travel to alert drivers of a change in the environment. Milled rumble strips are currently the prevalent type among transportation agencies. Milled rumble strips are made by a milling machine, which cuts grooves in the pavement surface. Other types of rumble strips include rolled, formed, and raised. They differ primarily by the installation method, their shapes, and sizes. A similar type of experimental pavement surface treatment is known as the rumblewave surface. This is an undulating road surface that resembles a series of closely spaced speed humps using a sinusoidal profile. The amplitude of the waves are about 1/4 of an inch, and the wavelength is about 1.1 ft.</p>			
<p>Effectiveness: The estimated effects of rumble strips on speeds are unknown (Ray et al., 2008). ★★</p> <p>Rumblewave surfaces can be expected to reduce both mean and 85th percentile speeds by about 1 to 6% (Department for Transport, 2005). ★★</p> <p>Rumblewave surfaces can also be expected to reduce fatal and injury crashes by about 55% (Department for Transport, 2005). ★★</p>			
<p>Cost: Low. Rumblewave surfaces are more costly (moderate to high).</p>	<p>Contraindications: Rumble strips (or rumblewave surfaces) may cause maintenance concerns, particularly in climates with snow and ice. Rumble strips may also generate excessive noise for nearby residents.</p>	<p>Installation Location: Rumble strips (or rumblewave surfaces) can be implemented within the perception-reaction area or near the start of the deceleration area.</p>	

Source: Corkle et al., 2001A

Source: NCHRP 737 Design Guidance for High-Speed to Low-Speed Transition Zones for Rural Highways

EXHIBIT 4-12: SPEED REDUCTION TREATMENT; COLORED PAVEMENT

Treatment: Colored pavement		Category: Surface treatment	
Description: The use of colored pavement to delineate the functional space of the roadway and to alert drivers of a change in the environment.			
Effectiveness: Colored pavement can be expected to reduce the mean and 85th percentile speeds by 17% (Russell and Godavarthy, 2010). ★			
Cost: Moderate.	Contraindications: The friction properties of the pavement surface could potentially be compromised.	Installation Location: Colored pavement can be implemented anywhere in the transition zone, but may be best suited to the perception-reaction area and/or in conjunction with a gateway treatment.	

Source: Russell and Godavarthy (2010)

Source: NCHRP 737 Design Guidance for High-Speed to Low-Speed Transition Zones for Rural Highways

EXHIBIT 4-13: SPEED REDUCTION TREATMENT; WELCOME SIGN

Treatment: Welcome sign		Category: Roadside treatment	
Description: A physical landmark or freestanding structure on the roadside that indicates a change in environment. This landmark/structure can be a simple sign with the name of the community or an archway that bridges the roadway.			
Effectiveness: Welcome signs consisting of freestanding structures and roadside signs are not detrimental to safety (Veneziano et al., 2009). ★★			
Cost: Low.	Contraindications: Implementation may increase the potential for single-vehicle, fixed-object crashes.	Installation Location: A welcome sign should be implemented within the deceleration area of the transition zone at or near the community threshold and/or in conjunction with a gateway treatment.	

Source: NCHRP 737 Design Guidance for High-Speed to Low-Speed Transition Zones for Rural Highways

4.4 TRAVEL LANES

The width of travel lanes is selected through consideration of the existing and future street context, approach to multimodal accommodation, the physical dimensions of vehicles, speeds, and other traffic flow characteristics. The normal range of lane width is between 10 and 12 feet. Travel lanes between 11 and 12 feet wide are desirable for roadways with higher design speeds (50 miles per hour or more), higher traffic volumes, or higher truck and bus activity. At lower design speeds, the Green Book notes lane widths between 10 and 12 feet for urban and rural arterials are appropriate. The Green Book notes that “Under interrupted-flow operating conditions at low speeds (design speed of 45 mph or less), narrower lane widths are normally adequate and have some advantages”. Nine-foot lanes may be acceptable on low-volume roads in rural and residential areas.

AASHTO Roadway Design Speed Classification

Low-speed is typically ≤ 45 mph

High-speed is typically ≥ 50 mph.

Widths of travel lanes on roadways with design speeds of 45 mph and below should be selected based on multimodal safety and capacity, as well as broader community goals. From a safety perspective, the Midwest Research Center has conducted extensive research on the relationship of arterial lane width to safety. Generally speaking, 10-foot lanes are no less safe than wider lanes on arterials with speeds of 45 mph or less.

Traffic engineering guidance has traditionally stated that the capacity of an urban street lane is decreased at widths below 12 feet. However, more recent research concluded that lanes between 10 feet and 12 feet have roughly the same capacity. Therefore, the 2010 Highway Capacity Manual adjustment factor for lane widths at signalized intersections is 1.00 for lanes ranging from 10 feet to 12.9 feet.

Given research indicating the acceptability of 10-foot lanes on urban streets, there are many circumstances in which 10-foot lanes are desirable in low-speed urban settings. Urban streets with design speeds less than 45 mph that do not have considerable bus or truck traffic should be candidates for 10-foot lanes. This is especially true when narrower lanes create the ability to develop a shoulder, bicycle lane (preferably with buffer), on-street parking, or improved pedestrian facilities.

While lane width reduction is generally accepted and has demonstrated to be a useful tool in reducing motor vehicular speeds, special attention should be made to recommending 10-foot lane widths adjacent to unbuffered bicycle and on-street parking facilities. Bicyclists will typically travel approximately 2.5 feet from the curb in a five-foot bicycle lane. With motor vehicle standard operating widths of seven to 8.5 feet, depending on vehicle type, and with a standard 18-inch operating width of a bicycle, and assuming motorists and bicyclists travel in the center of their lanes, these minimal dimensions cause a violation of the current three-foot passing law in Tennessee.

A case where 10-foot wide travel lanes should be avoided is on four-lane undivided arterial roadways. Ten-foot lanes create an added risk of head-on collisions due to the lack of median and presence of adjacent traffic. In general, lane widths of 11 feet should be used where larger vehicles such as trucks, emergency vehicles, or buses represent a significant percentage of the traffic stream and are laterally positioned adjacent to each other. Modern buses can be 10.5 feet wide from mirror to mirror and operate more comfortably in a minimum 11-foot wide lane.

With these few caveats, narrower lanes, as an element of an integrated urban street design, can contribute to lower vehicular operating speeds. By narrowing lanes, space can be reallocated and used for a separated bicycle lane, bicycle buffers, a widened sidewalk, or on-street parking. Narrower lanes also reduce pedestrian crossing distances.

Exhibit 4-14 summarizes when various lane widths are considered appropriate on TDOT projects.

EXHIBIT 4-14: RANGE OF TRAVEL LANE WIDTHS

Travel Lane Widths (ft)					
Context / Roadway	Rural	Rural (Town)	Suburban	Urban	Urban (Core)
Principal Arterial	11 to 12	11 to 12	11 to 12	10 to 12	10 to 12
Minor Arterial	11 to 12	10 to 12	10 to 12	10 to 12	10 to 12
Collector	11 to 12	10 to 12	10 to 12	10 to 12	10 to 12
Local	9 to 12	9 to 12	9 to 12	10 to 12	9 to 12
<ul style="list-style-type: none"> • Minimum 11-foot lanes are required for design speeds of 45 mph or greater. The values assume rural areas have design speeds of 45 mph or greater, except on local streets. • Curbside lanes with fixed-route transit service should be 11 feet wide (min.). 					

Source: Adapted from AASHTO Green Book, Mass DOT, and ITE Traffic Engineering Handbook

4.5 SHOULDERS

Shoulders are paved and graded areas along the travel lanes to serve a number of purposes as shown in Exhibit 4-15. Shoulders do not include on-street parking since the shoulders cannot serve the purposes listed in Exhibit 4-15 if they are occupied by parked cars. Paved shoulders provide a recovery area for errant motor vehicles, space for disabled vehicles, and lengthen the lifespan of the roadway by providing pavement structural support, reducing edge deterioration, and improving drainage. Paved shoulders reduce maintenance costs and reduce crashes. Additionally, paved shoulders provide space for occasional pedestrian and bicycle use.

EXHIBIT 4-15: MINIMUM SHOULDER WIDTH (IN FEET) TO PROVIDE VARIOUS FUNCTIONS

Shoulder Function	Roadway Type	
	Arterials	Collectors
Drainage of Traveled Way	1.0	1.0
Lateral Support of Pavement	1.5	1.0
Encroachment of Wide Vehicles	2.0	2.0
Off-tracking of Wide Vehicles	2.0	2.0
Errant Vehicles	3.0	2.0
Bicycle and Pedestrian Use	4.0	4.0
Emergency Stopping	6.0	6.0
Emergency Travel	6.0	6.0
Mail Delivery and Garbage Pickup	6.0	6.0
Law Enforcement Operations	8.0	6.0
Large Vehicle Emergency Stopping	10.0	10.0
Occasional Travel/Detours	10.0	9.0
Highway Maintenance	8.0	8.0

Source: *Flexibility in Highway Design*, AASHTO 2004. Chapter 6 Cross Section Elements

Except where expressly prohibited, pedestrians may legally walk on roadway shoulders. Most highway shoulders are not intended for use by pedestrians but can accommodate occasional pedestrian use.

When accommodation of pedestrian travel is warranted, pedestrian facilities should be provided. The preferred facility for pedestrian travel along a street is a sidewalk. Shoulders are not substitutes for a well-designed pedestrian facility. However, there may occasionally be a need to design shoulders as walkways where roadside space is constrained.

The Pennsylvania Department of Transportation (PennDOT) has adopted design standards specifically to make shoulders accessible. Along some roadways, sidewalks are not feasible and pedestrian use is expected to be only occasional. While some transportation agencies install paved shoulders along these roadways, PennDOT goes the extra mile for pedestrians. To better provide for pedestrians who may need to walk on these shoulders, PennDOT constructs the shoulders to be compliant with the Public Rights-of-Way Accessibility Guidelines (*PROWAG*). Cross slopes are kept to a two percent maximum and detectable warning strips are installed at crosswalks.

Source: FHWA State Best Practice Policy for Shoulders and Walkways

If a shoulder is intended to serve as part of a pedestrian access route, then the shoulder must meet *PROWAG* requirements for pedestrian walkways. So a wheelchair user does not have to enter the roadway to pass another user, shoulders used to accommodate pedestrians should be at least 5 feet wide to maintain a consistent shoulder width. If rumble strips are used on the shoulder, 5 feet should be provided beyond the rumble strips so pedestrians do not have to travel over a vibratory surface. Periodic gaps in the rumble strips may also be provided to allow pedestrians to move across the rumble strip pattern as needed. TDOT's Standard Drawings

provide guidance on rumble strip design with gaps. The maximum cross slope on a shoulder serving as part of an accessible route is two percent (2%). At intersections, detectable warning strips should be located across the ends of crosswalks outside of the roadway to indicate crossing locations.

Shoulders, even if not marked or signed for bicycle use, can provide accommodation for the occasional cyclist, if wide enough. When accommodation of bicycle travel is warranted, designated space for their use is preferred to an unmarked shoulder. Treatments for bicycle facilities are discussed in Section 6.0 *Bicycle Facilities*.

Exhibit 4-16 provides ranges of paved shoulder width for different areas and roadway types. Minimum four-foot shoulders are recommended for all arterials and collectors because of the value they provide for bicycle and pedestrian accommodation and motor vehicle safety. Whenever possible, five-foot minimum shoulders should be provided (six-foot preferred) when the shoulder will be designated as a bicycle lane (see Section 6.2). Shoulders narrower than four feet may be appropriate in constrained areas where separate pedestrian accommodation is provided and shared bicycle/motor vehicle accommodation is suitable. Although there is no exact criteria, the National Association of City Transportation Officials (NACTO) guidance states that bicycle lanes are most beneficial on streets with greater than 3,000 motor vehicle average daily traffic and streets with a posted speed limit of 25 mph or higher.

EXHIBIT 4-16: RECOMMENDED PAVED WIDTHS OF SHOULDERS (FEET)

Recommended Minimum Paved Shoulder Widths (ft) for Multimodal Accommodations			
Context / Roadway	Rural & Rural (Town)	Suburban	Urban & Urban (Core)
Principal Arterial	4 to 10	4 to 10	4
Minor Arterial	4 to 10	4 to 10	4
Collector	4 to 6	4 to 6	4
Local	0 to 4	0 to 4	0 to 4

- Shoulders narrower than four (4) feet may be appropriate in constrained areas where separate pedestrian accommodation is provided and shared bicycle/motor vehicle accommodation is suitable. Examples of these conditions are where design speeds are less than 45 miles per hour and traffic volumes are relatively low (less than 4,000 vehicles per day), or where the design speed is 30 miles per hour or less.
- For shoulders four (4) to five (5) feet wide, an additional two (2)- to one (1)-foot offset (respectively) from the edge of the paved shoulder is required to vertical elements over 6 inches in height (such as guardrail).
- Five (5)-foot minimum width shoulders are recommended when the shoulder will be designated as a bicycle lane.

Source: Adapted from AASHTO Green Book, Mass DOT, and ITE Traffic Engineering Handbook

4.6 CURB LANE PLUS SHOULDER WIDTH

For arterial and collector roadways, the combined width of the outside lane plus shoulder available for bicycle and motor vehicle travel is an important design element. A 14-foot outside lane/shoulder width combination will allow a motor vehicle to pass a bicyclist without needing to change lanes (on a multilane section) or swerve into the oncoming lane (on a two-lane section) and is the minimum recommended combined width for collector and arterial streets.

4.7 TURN LANES

Turn lanes at intersections help facilitate traffic movements. On higher-speed roadways, turn lanes reduce rear-end, sideswipe, and left-turn collisions. However, turn lanes do have negatives. They require additional right-of-way, and in a multimodal environment, turn lanes make pedestrian crossings longer and can create challenges with bicycle lane design at intersections. Turn lanes should typically not be provided in low-speed urban environments if acceptable vehicular levels of service can be attained without them.

When turn lanes are needed, they should be as wide as the through-traffic lanes, but not less than 10 feet. Where continuous two-way left-turn lanes are provided, they should be 10 to 16 feet wide. Additional guidance for turn lane geometry is provided below.

- Lane width - preferred as wide as the adjacent through lane, but at least 10 feet,
- Deceleration length - on high-speed routes the preference is for the turn lane to be long enough such that no deceleration occurs in the through lane, though 10 mph may be allowed; on low-speed urban routes this is often not attainable
- Storage length - enough to store expected number of Design Vehicles during a critical period, with a minimum length of 100 feet on TDOT projects. On non-TDOT projects, if the local jurisdiction allows, turn lanes may be as short as 50 feet (two passenger car lengths).

4.7.1 Left-Turn Lanes

Left-turn lanes can reduce the potential for collisions and improve capacity by removing stopped vehicles from the main travel lane. TDOT's *Roadway Design Guidelines* provides guidance where left turn lanes are warranted along higher speed (over 40 mph) unsignalized routes (Section 2-170.00, Figures 2-17 through 2-20F). In slower-speed urban environments, a multimodal traffic analysis should be developed to determine the need for a turn lane, and assess if the benefit to motorists is worth the impact to right-of-way/utilities, pedestrians, and bicyclists.

4.7.2 Right-Turn Lanes (& Channelized Islands)

Use of right-turn lanes should be limited under low right-turn volume conditions. A right-turning volume threshold of 200-300 vph is the minimum range for the consideration of right-turn lanes. Where it is determined that a right-turn lane is appropriate, a channelizing island can help slow traffic and separate conflicts between right-turning vehicles and pedestrians. However, channelized right-turn lanes can make it difficult to implement exclusive pedestrian signal phases to assist pedestrians in crossing the street.

Where channelized right-turn lanes are used, they should be designed to meet the criteria listed in Section 4.2 *Curb Radii*.

4.8 MEDIANS

Medians vary in width and purpose and can be raised with curbs, painted and flush with the pavement, or depressed with vegetation. Operational and safety benefits of medians include storage for turning vehicles, enforcing turn restrictions, access management, reducing conflicts, pedestrian refuge, snow storage, reducing certain types of crashes such as head-on collisions, and space for vehicles crossing the roadway at unsignalized intersections.

In contrast to medians in rural areas, the width of medians in urban areas should only be as wide as necessary to provide the desired function (accommodation of left turning vehicles, pedestrian refuge, etc.). Where intended to be used for pedestrian refuge, medians should be wide enough to accommodate groups of pedestrians, wheelchair users, bicyclists, and people pushing strollers. A minimum width of eight feet is recommended, exclusive of the width of curbs. This allows two feet of clearance from the roadway on each side and four feet of linear storage area, which will accommodate the full length of most wheelchairs. Detectable warning strips will occupy the two feet required for clearance. Six-foot wide medians are acceptable if right-of-way is constrained, but will not function as an official pedestrian refuge because detectable warning strips cannot be installed while still providing a four-foot storage area due to the space limitation. On routes with medians that are less than eight feet wide, pedestrian signals shall be timed to allow for full crossing of the roadway in one cycle. At locations where bicycles may be crossing, such as where a shared use path crosses a roadway, a 10-foot median is preferred in order to accommodate a bicycle with a trailer. Narrow medians (less than four feet) should only be used to restrict turning movements, to separate opposing directions of traffic and provide space for traffic control devices, and not intended for pedestrian refuge. Median widths should typically not exceed 18 feet in walkable urban environments, except on parkways or where dual left turns are provided. Institute of Transportation Engineers (ITE) recommended median widths are provided in Exhibit 4-17. Preferred dimensions for both cut-through and ramped medians are shown in Exhibit 4-18.

Raised medians in low-speed urban contexts should be constructed with vertical curbs to provide refuge for pedestrians, access management, and a place to install signs, utilities, and landscaping. If emergency access is a concern, mountable curbs should be considered in special locations (where medians are carried across intersections or along access managed roadways near fire stations). Mountable medians can be reinforced with added rebar to improve durability.

At lower urban speeds (25 to 30 mph) where constraints are present, there is no need to provide an offset between the median curb face and travel lane. The inside travel lane can be paved directly against the face of the median curb unless a gutter pan is required for drainage.

At intersection crossings, where the median is wide enough, it is good practice to extend the median nose beyond the crosswalk to provide an enclosed pedestrian refuge (see Exhibit 4-18 and Exhibit 4-19).

EXHIBIT 4-17: ITE RECOMMENDED MEDIAN WIDTHS

Thoroughfare Type	Minimum Width	Recommended Width
Median for access control		
All thoroughfare types	4 feet	6 feet ¹
Median for pedestrian refuge		
All thoroughfare types	6 feet	8 feet
Median for street trees and lighting		
All thoroughfare types	6 feet ²	10 feet ³
Median for single left-turn lane		
Collector avenues and streets	10 feet ⁴	14 feet
Arterial boulevards and avenues	12 feet	16-18 feet
Median for dual left-turn lane		
Arterial boulevards and avenues	20 feet	22 feet
Median for transitway		
Dedicated rail or transit lanes	22 feet	22-24 feet
Added median width for platforms	10 feet for each side platform 30 feet for center platform	

¹ A 6-foot-wide median is the minimum width for providing a pedestrian refuge.

² Six feet (measured between curb faces) is generally considered a minimum width for proper growth of small trees less than 4 inches in diameter at maturity. A 10-foot median is recommended for larger trees.

³ Wider medians to provide generous landscaping are acceptable, if desired by the community. However, avoid designing medians wider than necessary to support its desired function at intersections. This can reduce the operational efficiency of the intersections and invite undesirable behavior of crossing traffic such as side-by-side queues, angled stopping and so forth.

⁴ A 10-foot wide median allows for a striped left-turn lane (9 to 10 feet wide) without a median nose.

Source: ITE Designing Walkable Urban Thoroughfares, as CSS Approach, Table 9.1

EXHIBIT 4-18: MEDIAN REFUGE ISLAND MINIMUM RECOMMENDED DIMENSIONS

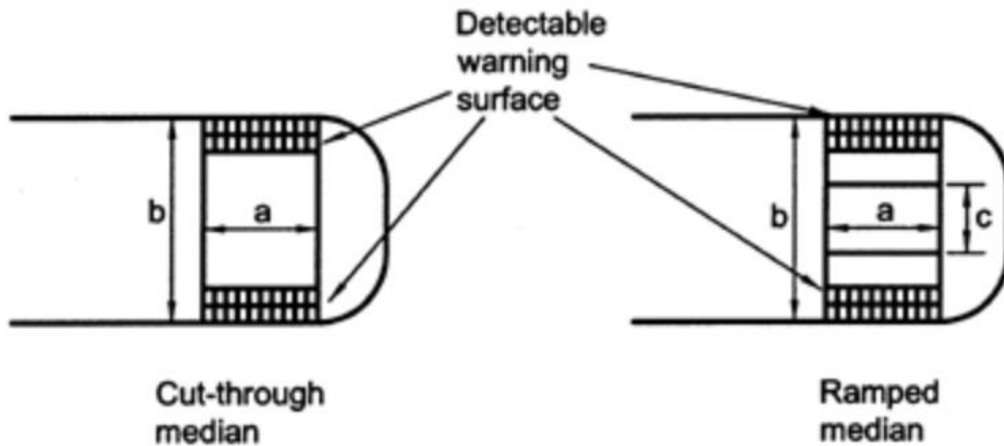

- Key Dimensions:
- a: 5-foot to allow two wheelchairs to pass
 - b: 8-foot preferred to allow 4-foot landing area and 2-foot detectable warning strips on either side
 - c: 4-foot minimum, 5-foot preferred

Source: <https://www.fhwa.dot.gov/publications/research/safety/04091/08.cfm#chp81> , with some dimensions from PROWAG and ITE

EXHIBIT 4-19: MEDIAN NOSE ON CUT-THROUGH MEDIAN



Source: http://safety.fhwa.dot.gov/intersection/other_topics/fhwasa06016/chap_6.htm via Charlotte DOT
 Note: See Section 7.1 for guidance on detectable warning surfaces.

4.9 ON-STREET PARKING

On-street parking should only be provided on low-speed streets with operating speeds at or less than 35 mph. When a proposed project is to include on-street parking, parallel parking is typically recommended. Parallel parking serves as a good traffic calming tool, and provides a buffer between the travel lane and the sidewalk (where a sidewalk exists). The allowance for on-street parking should be based on the function and width of the street, the adjacent land use, and traffic volume, as well as existing and anticipated traffic operations.

On-street parking should only be provided on streets with operating speeds at or less than 35 mph.

Most vehicles will parallel park within six to 12 inches of the curb face and will occupy approximately seven feet of actual street space. Therefore, the recommended minimum width of a parking lane is eight feet, inclusive of the gutter pan. However, on urban collector streets within residential neighborhoods where only passenger vehicles need to be accommodated in the parking lane, seven-foot wide parking lanes are acceptable. In many urban areas a total street width of 36 feet is frequently used, consisting of two 11-foot travel lanes and seven-foot parking lanes on each side.

On-street parking is generally permitted on local streets. A 26-foot wide roadway is the typical cross section used in many urban residential areas. This width assures one through lane even where parking occurs on both sides. Specific parking lanes are not usually designated on local streets. The lack of two moving lanes may be inconvenient to the motorist; however, the frequency of such concerns is low. Random intermittent parking on both sides of the street usually results in areas where two-way movement can be accommodated.

In urban areas, central business districts, and commercial areas where significant pedestrian crossings are likely to occur, the design of the parking lane/intersection relationship must be considered. When the parking lane is carried through the intersection, motorists may utilize the parking lane as an additional lane for right turn movements. Such movements may cause operational inefficiencies and turning vehicles may mount the curb and strike such roadside elements as traffic signals, utility poles, or luminaire supports. One method to address this issue is to end the parking lane at least 20 feet in advance of the intersection and create a curb extension. Curb extensions also shorten the crossing width for pedestrians and improve safety by making the pedestrian more visible to the motorist. An example of such treatment is shown in Exhibit 4-20 and is discussed in more detail in Section 7.4.1 *Curb Extensions/Bulb-Outs*.

EXHIBIT 4-20: PARALLEL PARKING DESIGN

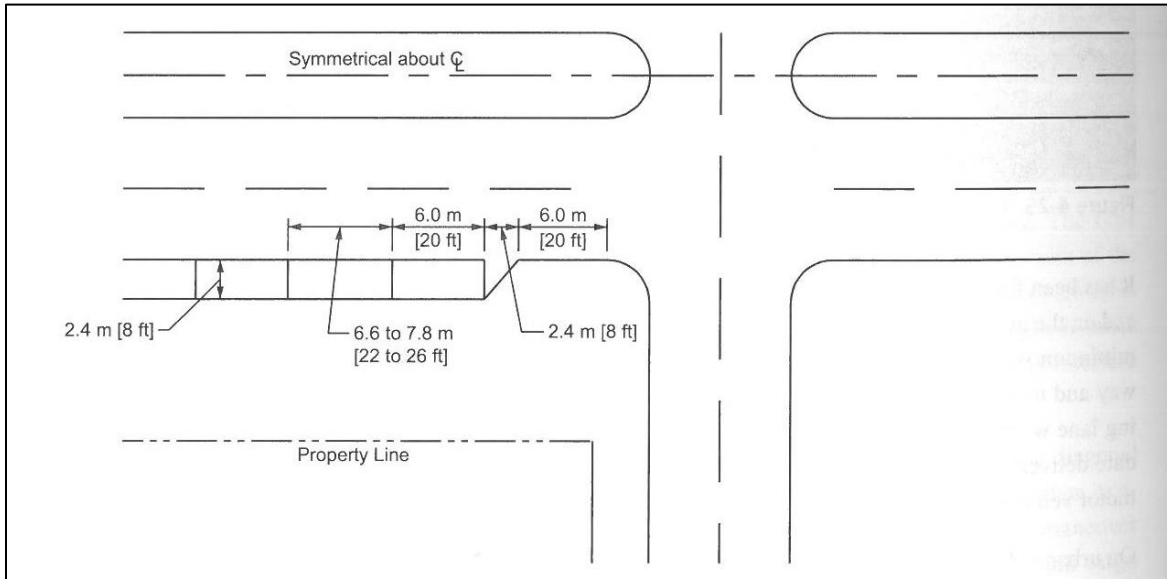

Source: AASHTO Green Book (2011), Figure 4-26

Under certain circumstances, angle parking is acceptable. Angle parking presents challenges that must be considered related to the varying lengths of vehicles and the sight distance problems associated with larger vehicles, including vans. The type of on-street parking for a street or corridor should be selected based on the function and width of the street, the adjacent land use, traffic volume, and existing and anticipated traffic operations.

Angle parking is permissible where operating speeds are 25 mph or less and the delay produced by parking maneuvers is acceptable. Traditional, front-in angle parking is shown in Exhibit 4-21. Where practical or on bicycle routes, back-in angle parking is preferable to front-in angle parking.

Exhibit 4-22 shows how drivers maneuver back-in angle parking. Back-in angle parking provides improved visibility for the driver to see motor vehicle and bicycle traffic when exiting the parking space. Bicycle lanes should not be placed adjacent to conventional front-in diagonal parking, since drivers in the parking spaces have poor visibility of bicyclists in the bike lane.

The trade-offs associated with different angles of parking include: (a) lower-angle parking results in fewer parking spaces; (b) higher-angle parking requires a wider adjacent travel lane to keep parked vehicles from backing into the opposing travel lane when exiting the parking space; and (c) back-in angle parking requires a wider edge zone in the street-side due to the longer overhang at the rear of most vehicles.

EXHIBIT 4-21: TRADITIONAL ANGLE PARKING

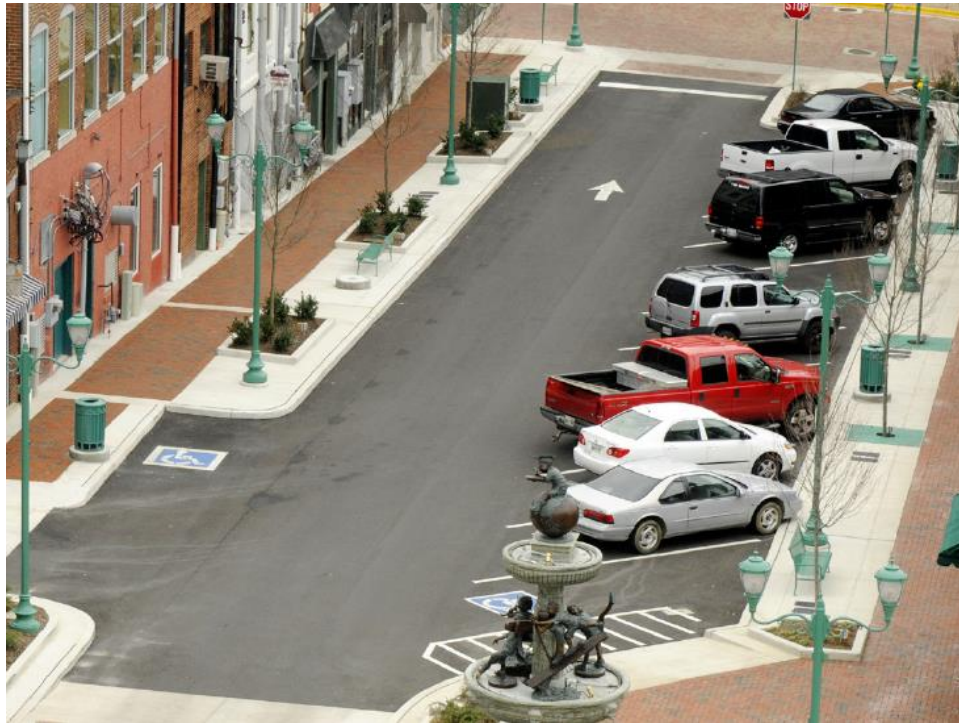
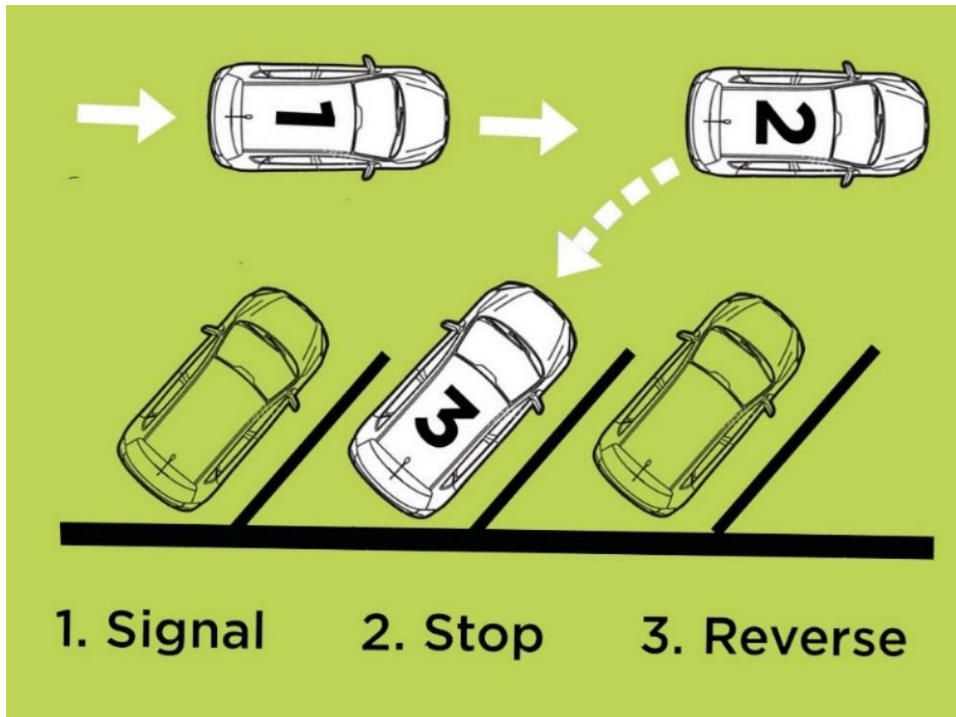

EXHIBIT 4-22: BACK-IN ANGLE PARKING



Source: State of Indiana via <http://the419.com/243/>

4.10 URBAN FREIGHT AND DELIVERIES

Urban populations need goods and services. The needs of urban freight and refuse removal should be considered when designing streets in urban environments.

Local government planning agencies typically regulate building codes and design standards. Building codes typically include design standards relevant to urban goods movements such as the number, location, and design of loading docks, as well as parking lots and related facilities on the site.

City codes and regulations may restrict the time of day that trucks may stop to pick up and deliver goods, or in some cases raise the cost of parking during peak periods. Most cities that apply time-of-day restrictions do so to prevent deliveries during hours when pedestrian traffic is heaviest or during peak commuter periods. Some cities have applied daytime delivery bans on specific types of goods such as hazardous materials, or during special events.

Most curbside parking/freight delivery space, even for commercial purposes, is designed for small vehicles such as pickup trucks, vans, and single-unit trucks. Curbside management can be enhanced using a variety of methods, including strict enforcement of designated commercial parking zones for use by commercial vehicles only, providing larger curbside parking spaces, increasing the frequency of commercial curbside spaces, designating commercial curb parking during peak periods, and peak-hour pricing mechanisms to regulate parking behavior.

4.11 ROUNDABOUTS

In the appropriate circumstances, significant benefits can be realized by constructing modern roundabouts in place of stop or signal controlled intersections. The benefits include improved safety, speed reduction, reduction of certain types of motor vehicle crashes, and operational functionality and capacity. Roundabouts can also serve as a gateway or focal point for a community, such as shown in Exhibit 4-23. NCHRP 672, *Roundabouts an Informational Guide Second Edition* (2010) notes that modern roundabouts have an observed reduction of 35 and 76 percent in total and injury crashes, respectively, compared to stop and signal controlled intersections.

The designer should be familiar with the crosswalk design requirements in the MUTCD and the United States Access Board's *Proposed Accessibility Guidelines for Pedestrian Facilities in the Public Right-of-Way*, which is commonly known as the PROWAG. For example, PROWAG requires the use

of High-Intensity Activated Crosswalk (HAWK) Pedestrian Hybrid Beacons (PHBs) to assist the visually impaired when crossing an approach to a multilane roundabout. PHBs are not required by PROWAG or any other source for single-lane roundabout crossings.

High-level guidance concerning the applicability of different roundabout designs for various roadway classifications and land-use contexts is provided in Exhibit 4-24. A detailed traffic and geometric analysis is required to verify if a roundabout will work in a specific location, as turning movement patterns, horizontal alignment, and roadway grades are important factors in roundabout analysis.

EXHIBIT 4-23: SUBURBAN MULTIMODAL ROUNDABOUT



Source: <https://www.dot.ny.gov/programs/completestreets>

EXHIBIT 4-24: ROUNDABOUT APPLICABILITY GUIDANCE

Parameter	Mini Roundabout	Urban Compact Roundabout	Urban Single-Lane Roundabout	Urban Double-Lane Roundabout
Maximum Entry Speed (mph)	15	15	20	25
Design Vehicle	Bus and Single Unit Truck drive over apron	Bus and Single Unit Truck	Bus and Single Unit Truck. Intermediate Semi-Trailer with lane encroachment on truck apron	Bus and Single Unit Truck. Interstate Semi-Trailer with lane encroachment on truck apron
Inscribed Circle Diameter (feet)	45 to 80	80 to 100	100 to 130	150 to 180
Maximum Number of Entering Lanes	1	1	1	2
Typical Capacity (Vehicles per Day entering from all approaches)	10,000	15,000	20,000	40,000
Applicability by Roadway Type				
Arterial	No	No	Yes	Yes
Collector	Yes	Yes	Yes	Yes
Local Street	Yes	Yes	Yes	No

Source: Developed with data from Table 10.2 of ITE's Designing Walkable Urban Thoroughfares, a Context Sensitive Approach and FHWA's Roundabouts: An Informational Guide

4.12 ROADWAY DESIGN ELEMENTS SUMMARY

Exhibit 4-25 summarizes recommended lane and shoulder widths on TDOT projects.

EXHIBIT 4-25: LANE AND PAVED SHOULDER WIDTH SUMMARY

Context/ Roadway		Rural	Rural (Town)	Suburban	Urban	Urban (Core)
Principal Arterial	Lane Width	11 to 12	11 to 12	11 to 12	10 to 12	10 to 12
	Shoulder Width	4 to 10	4 to 10	4 to 10	4	4
Minor Arterial	Lane Width	11 to 12	10 to 12	10 to 12	10 to 12	10 to 12
	Shoulder Width	4 to 10	4 to 10	4 to 10	4	4
Collector	Lane Width	11 to 12	10 to 12	10 to 12	10 to 12	10 to 12
	Shoulder Width	4 to 6	4 to 6	4 to 6	4	4
Local	Lane Width	9 to 12	9 to 12	9 to 12	10 to 12	9 to 12
	Shoulder Width	0 to 4	0 to 4	0 to 4	0 to 4	0 to 4

- See Section 4.6 for discussion concerning curb lane plus shoulder widths.
- Five-foot minimum width shoulders are recommended when the shoulder will be designated as a bicycle lane (see Section 6.2).
- For shoulders four to five feet wide, an additional two- to one-foot offset (respectively) from the edge of the paved shoulder is required to vertical elements over six inches in height (such as guardrail).
- Shoulder widths apply with or without curb and gutter.

4.13 SECTION 4.0 SOURCES

1. American Association of State Highway and Transportation Officials. (2011). *A Policy on Geometric Design of Highways and Streets*. Washington, D.C.
2. American Association of State Highway and Transportation Officials. (2004). *Flexibility in Highway Design*. Washington, D.C.
3. Broward County, FL MPO (2012). *Broward Complete Streets Guidelines*. Broward County, FL.
4. Federal Highway Administration. (2016). *Achieving Multimodal Networks, Applying Design Flexibility & Reducing Conflicts*. Washington, D.C.
5. Federal Highway Administration. *Engineering Speed Management Countermeasures: A Desktop Reference of Potential Effectiveness in Reducing Crashes*. Retrieved January 31, 2017 from http://safety.fhwa.dot.gov/speedmgt/ref_mats/eng_count/2014/reducing_crashes.cfm
6. Federal Highway Administration. (2016). *Integrating Speed Management within Roadway Departure, Intersections, and Pedestrian and Bicyclist Safety Focus Areas*. Washington, D.C.
7. Federal Highway Administration. (2012). *Manual on Uniform Traffic Control Devices*. Washington, D.C.
8. Federal Highway Administration. (2015). Memorandum: Relationship between Design Speed and Posted Speed. Retrieved December 28, 2016 from <https://www.fhwa.dot.gov/design/standards/151007.pdf>
9. Federal Highway Administration. (2000). *Roundabouts: An Informational Guide*. Washington, D.C.
10. Federal Highway Administration (2004). *Signalized Intersections: Informational Guide*. Washington, D.C.
11. Federal Highway Administration. *State Best Practice Policy for Shoulders and Walkways*. Retrieved November 15, 2016 from http://safety.fhwa.dot.gov/ped_bike/tools_solve/fhwasa11018/fhwasa11018.pdf
12. Institute of Transportation Engineers. (2010). *Designing Walkable Urban Thoroughfares, a Context Sensitive Approach*. Washington, D.C.
13. Institute of Transportation Engineers. (2016). *Traffic Engineering Handbook, Seventh Edition*. Hoboken, NJ.
14. Massachusetts Highway Department. (2006). *Project Development and Design Guide*. Chapter 5. Boston, MA.
15. National Association of City Transportation Officials. *Speed Reduction Mechanisms*. Retrieved November 7, 2016, from <http://nacto.org/publication/urban-street-design-guide/design-controls/design-speed/speed-reduction-mechanisms/>.
16. National Association of City Transportation Officials. (2012). *Urban Street Design Guide*. New York, NY.
17. National Cooperative Highway Research Program. (2011). *Crossing Solutions at Roundabouts and Channelized Turn Lanes for Pedestrians with Vision Disabilities*.

- Report 674. The National Academies of Sciences, Engineering, and Medicine, Washington, D.C.
18. National Cooperative Highway Research Program. (2012). *Design Guidance for High-Speed to Low-Speed Transitions Zones for Rural Highways*. Report 737. The National Academies of Sciences, Engineering, and Medicine, Washington, D.C.
 19. National Cooperative Freight Research Program. (2012). *Guidebook for Understanding Urban Goods Movement*. Transportation Research Board. Washington, D.C.
 20. National Cooperative Highway Research Program. (2016 Draft). *Proposed Update of the AASHTO Guide for the Planning, Design, and Operation of Pedestrian Facilities*. Report 15-45 (Draft). The National Academies of Sciences, Engineering, and Medicine, Washington, D.C.
 21. National Cooperative Highway Research Program. (2010). *Roundabouts: An Informational Guide 2nd Edition*. Report 672. The National Academies of Sciences, Engineering, and Medicine, Washington, D.C.
 22. United States Access Board. (2011). *Proposed Accessibility Guidelines for Pedestrian Facilities in the Public Right-of-Way*. Washington, D.C.

[This page intentionally left blank]

5.0 ROAD DIETS

Road diets (sometimes referred to as “road reconfigurations”) are the reconfiguration of one or more travel lanes to calm traffic and provide space for bicycle lanes, turn lanes, streetscapes, wider sidewalks, and other purposes. Four to three-lane conversions are the most common road diet, but there are numerous types (e.g., three to two lanes, or five to three lanes). FHWA has identified road diets as a proven safety countermeasure.

Streets are typically designed based on a forecast of future traffic volumes. At times these estimates are either incorrect or circumstances have changed, resulting in fewer motor vehicles than anticipated. The result is excess capacity, and streets that encourage fast speeds and create poor conditions for pedestrians, bicyclists, and transit users.

Four-lane undivided highways have a history of relatively high crash rates as traffic volumes increase and as the inside lane is shared by higher speed through traffic and left-turning vehicles. One option for addressing this safety concern is a road diet. The reduction of lanes allows the roadway cross section to be reallocated for other uses such as bicycle lanes, pedestrian refuge islands, transit stops, or parking.

EXHIBIT 5-1: EXAMPLE ROAD DIET

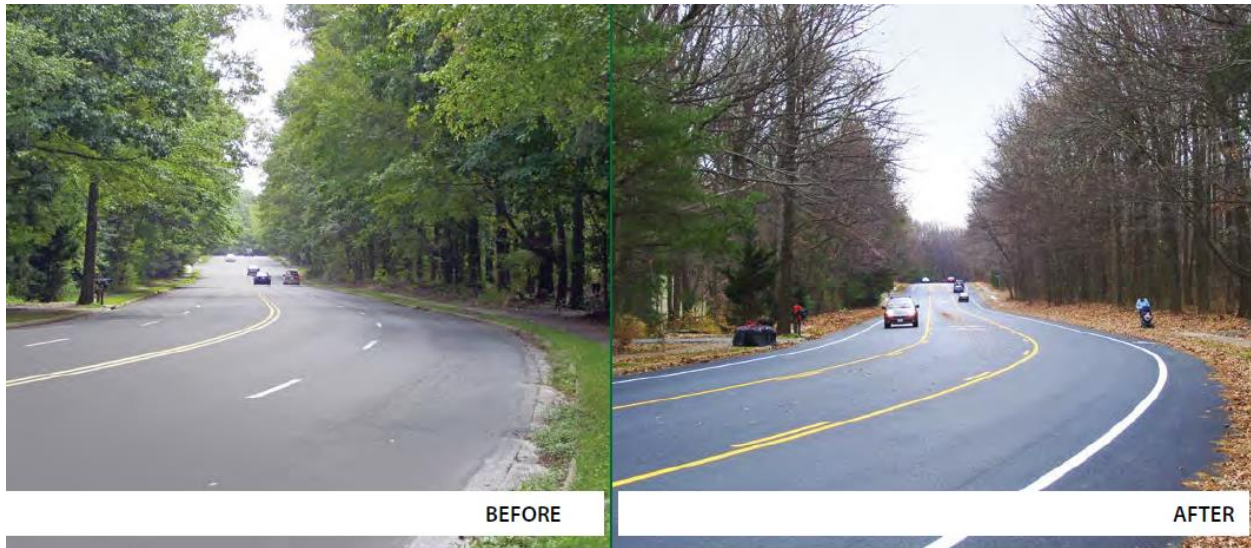

Source: FHWA Road Diet Informational Guide

EXHIBIT 5-2: EXAMPLE ROAD DIET



Source: Federal Highway Administration

5.1 BENEFITS OF A ROAD DIET

Benefits of road diet installations may include:

- An overall crash reduction of 19 to 47 percent².
- Reduction of rear-end and left-turn crashes through the use of a dedicated left-turn lane.
- Reduced right-angle crashes as side street motorists must cross only three lanes of traffic instead of four.
- Simplifying road scanning and gap selection for motorists (especially older and younger drivers) making left turns from or onto the mainline.
- Fewer lanes for pedestrians to cross and an opportunity to install pedestrian refuge islands in the median.
- The opportunity to install bicycle lanes when the cross section width is reallocated.
- Traffic calming and reduced speed differential, which can decrease the number of crashes and reduce the severity of crashes if they occur.
- The opportunity to allocate the “leftover” roadway width for other purposes, such as on-street parking or transit stops.
- The opportunity to implement during resurfacing projects.

5.2 ROAD DIET TRAFFIC CRITERIA

The roadway’s average daily traffic (ADT) provides a good first approximation whether to consider a road diet conversion. TDOT and FHWA advise that roadways with ADT of 25,000 or less may be candidates for a road diet and could be evaluated for feasibility. This is considerably higher volume than the maximum ADT of 12,500 specified for a new three-lane typical section in TDOT Standard Drawing D01-TS-7 DESIGN STANDARDS 2-LANE HIGHWAY WITH CONTINUOUS 2-WAY LEFT-TURN LANE. Therefore, TDOT requires further analysis to determine the operational feasibility of a road diet. In addition to the ADT being below 25,000, the hourly volumes should be below 1,700 vehicles per hour per lane. Other factors such as signal spacing, turning volumes at intersections and other access points, driveway density, and transit stops

² FHWA’s *Road Diet Informational Guide*

adversely affecting traffic flow must be considered. Other elements such as roadway classification, jurisdictional preference, and adjacent land use may also contribute to the applicability of a road diet. A traffic study that includes the results of a simulation study will typically be required.

5.3 SECTION 5.0 SOURCES

1. Federal Highway Administration. (2016). *Achieving Multimodal Networks, Applying Design Flexibility & Reducing Conflicts*. Washington, D.C.
2. Federal Highway Administration. (2014). *Road Diet Informational Guide*. Washington, D.C.
3. Oldham, J. (2015, October 6). *Draft Road Diet Best Practices Memorandum*. TDOT Traffic Engineering Office, Nashville, TN.
4. Tennessee Department of Transportation. (2002). *Standard Drawings RD01-TS-7 Design Standards 2-Lane Highway with Continuous 2-Way Left-Turn Lane and Design Standards 2-Lane Curb & Gutter with Continuous 2-Way Left-Turn Lane*. Retrieved March 22, 2017, from http://www.tn.gov/assets/entities/tdot/attachments/RD01TS7_101502.pdf and http://www.tn.gov/assets/entities/tdot/attachments/RD01TS7A_101502.pdf.

[This page intentionally left blank]

6.0 BICYCLE FACILITIES

The popularity of bicycling has drawn attention to methods for protecting bicyclists when they travel on public streets. Bicyclists are slower and less visible than motor vehicles. Between 2010 and 2012, U.S. bicyclist deaths increased by 16 percent. Other motor vehicle fatalities increased by one percent during this same time. Every year since 1975, bicyclist deaths have comprised two percent of all motor vehicle deaths nationwide. Bicycle facilities come in a variety of designs that vary by separation from motorized vehicular travel. These designs range, in order of least to most physical separation, from signed routes to off-street trails/shared-use paths (see Exhibit 6-1).

Except for on very low-speed, low-volume residential streets where pedestrians and bicyclists can comfortably share the roadway with motor vehicles, total physical separation is preferable to increase bicyclists' safety. This can be accomplished with shared-use paths and cycle tracks. Where these features are not feasible or where bicyclists prefer on-road facilities, the goal is to reduce the time or distance in which bicyclists are exposed to risk via marked bicycle lanes. Marked bicycle lanes can be supplemented by methods to slow motor vehicles down, and with roadway lighting and warning signs to increase awareness of the presence of bicyclists. The primary design concerns for bicycle facilities are cross section width and control at driveways and intersections.

It is important to note bicyclists are legitimate road users and, when operating in the road, have similar rights and responsibilities of motor vehicle operators. For information on bicycle laws in Tennessee, please refer to <https://www.tn.gov/tdot/multimodal-transportation-resources/bicycle-and-pedestrian-program/tennesse-bicycle-laws.html>.

EXHIBIT 6-1: BICYCLE FACILITY LEVELS OF SEPARATION

Least Separation



Signed Routes (No Pavement Markings)

A roadway designated as a preferred route for bicycles.



Shared Lane Markings

A shared roadway with pavement markings providing wayfinding guidance to bicyclists and alerting drivers that bicyclists are likely to be operating in mixed traffic.



On-Street Bike Lanes

An on-road bicycle facility designated by striping, signing, and pavement markings.



On-Street Buffered Bike Lanes

Bike lanes with a painted buffer increase lateral separation between bicyclists and motor vehicles.



Separated Bike Lanes

A separated bike lane is an exclusive facility for bicyclists that is located within or directly adjacent to the roadway and that is physically separated from motor vehicle traffic with a vertical element.



Off Street Trails / Sidepaths

Bicycle facilities physically separated from traffic, but intended for shared uses by a variety of groups, including pedestrians, bicyclists, and joggers.

Most Separation

Source: FHWA Applying Performance-Based Practical Design Methods to Complete Streets

6.1 SHARED LANES (SHARROWS)

On urban roadways with posted speed limits of 35 mph and below, the roadway lane may be marked as a shared lane, with “Share the Road” signage and Sharrow bicycle markings. For guidance concerning Sharrows, see the MUTCD Section 9C.07 and TDOT Standard Drawing T-M-11 SIGNING AND PAVEMENT MARKINGS FOR BICYCLE LANES OR ROUTES. Shared lanes are typically for retrofit situations on existing streets where constructing a separate bicycle facility is not feasible.

6.2 BICYCLE LANES

Bicycle lanes are appropriate on urban arterial and collector streets. Bicycle lanes may also be appropriate on rural roads where there is a high level of bicycle use. Bicycle lanes are generally not necessary on local streets with relatively low traffic volumes and speeds. Under these conditions, a shared roadway is typically the most appropriate facility. Although there is no exact criteria, the National Association of City Transportation Officials (NACTO) *Urban Bikeway Design Guide* notes typical bicycle lane applications are on streets with traffic volumes greater than 3,000 vehicles per day and posted speeds greater than or equal to 25 mph.

6.2.1 Bicycle Lane Design Criteria

The following geometric design criteria are established for bicycle lanes, and summarized in Exhibit 6-2.

- Preferred bicycle lane width (rideable surface) is six feet
- Typical bicycle lane width (rideable surface) is five feet
- Absolute minimum width is four feet
- Along sections of roadway with curb and gutter, a usable width of four feet measured from the longitudinal joint between the gutter and bike lane to the center of the bike lane pavement marking line is recommended; in areas where 4 feet cannot be achieved due to constraints, the absolute minimum width is 3 feet
- Buffered bicycle lanes are preferred to non-buffered lanes (see Section 6.2.2 for additional information on buffered bicycle lanes)
- Absolute minimum bicycle lane width adjacent to on-street parking is five feet unless there is a marked buffer between the bicycle lane and on-street parking. Where on-street parking is permitted, delineating the bicycle lane with two stripes, one on the street side and one on the parking side, is preferable to a single stripe
- For bicycle lanes four to five feet wide, an additional two- to one-foot offset (respectively) from the edge of the paved shoulder is required to vertical elements over 6 inches in height (such as guardrail)
- Gutter seams, drainage inlets, and utility covers should be flush with the pavement and oriented to prevent conflicts with bicycle tires
- Streets with high volumes of traffic and/or higher speeds need wider bicycle lanes than those with less traffic or slower speeds
- Bicycle lanes on one-way streets should generally be on the right side of the traveled way and should always be provided on both legs of a one-way couplet. The bicycle lane may be placed on the left side of a one-way street if it decreases the number of conflicts (e.g.,

those caused by heavy bus traffic or parking) and if bicyclists can conveniently transition in and out of the bicycle lane. If sufficient width exists, the bicycle lanes can be striped on both sides of a one-way street

- Where on-street parking is provided, bicycle lanes are generally striped on the left side of the parking lane

EXHIBIT 6-2: BICYCLE LANE DIMENSIONS

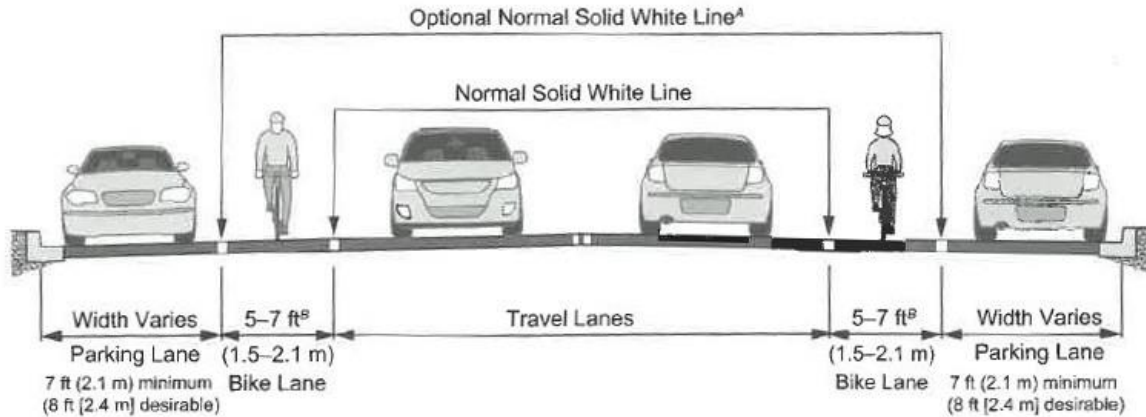

On Street Parking

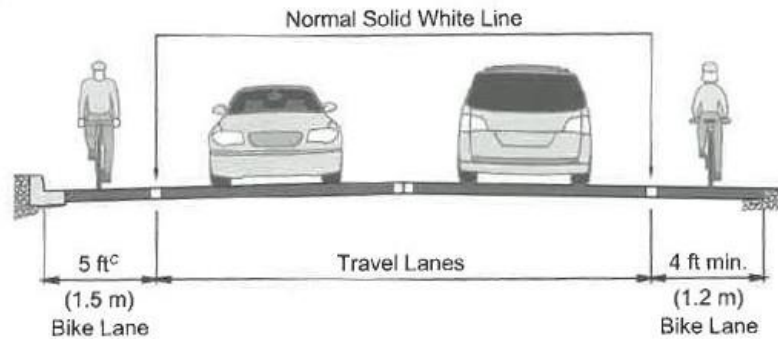

Parking Prohibited

Notes:

- ^A An optional normal (4-6-in./100-150-mm) solid white line may be helpful even when no parking stalls are marked (because parking is light), to make the presence of a bicycle lane more evident. Parking stall markings may also be used.
- ^B Bike lanes up to 7 ft (2.1 m) in width may be considered adjacent to narrow parking lanes with high turnover.
- ^C On extremely constrained, low-speed roadways (45 mph [70 km/h] or less) with curbs but no gutter, where the preferred bike lane width cannot be achieved despite narrowing all other travel lanes to their minimum widths, a 4-ft (1.2-m) wide bike lane can be used.

Source: AASHTO Guide for the Development of Bicycle Facilities, 4th Edition

6.2.2 Buffered Bicycle Lanes

Buffered bicycle lanes are conventional bicycle lanes paired with a designated buffer space separating the bicycle lane from the adjacent motor vehicle travel lane and/or parking lane. The

buffer space is created with pavement markings. When the buffer is placed between the traveled way and bicycle lane, it improves safety by separating bicyclists from moving motor vehicles. Buffers can also be placed between on-street parking lanes and bicycle lanes. When that configuration is selected, bicyclists have less risk of being hit by a car door being opened from a parked car. Both locations are acceptable, and the preferred placement of the buffer depends upon local conditions. Examples of buffered bicycle lanes are provided in Exhibit 6-3 through Exhibit 6-5.

Buffered bicycle lanes provide the following advantages when compared to conventional bicycle lanes.

- Provide greater shy distance between bicyclists and motor vehicles.
- Provide space for faster moving bicyclists to pass slower moving bicyclists without having to encroach into the motor vehicle travel lane.
- Provide a greater space for bicycling without making the bicycle lane appear so wide that it might be mistaken for a motor vehicle travel lane or a parking lane.
- Appeal to a wider range of bicyclists and encourages bicycling.

**EXHIBIT 6-3: BUFFERED BICYCLE LANE
(BETWEEN BOTH THE MOTOR VEHICLE AND PARKING LANES)**

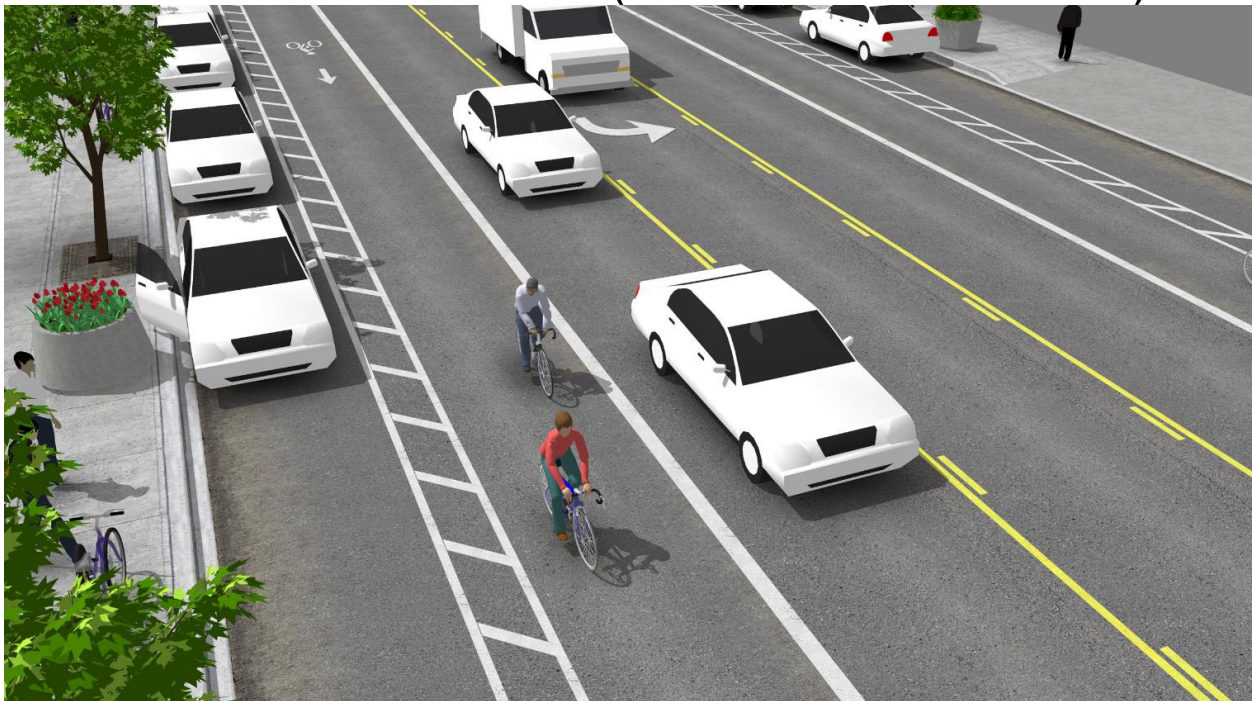

EXHIBIT 6-4: BUFFERED BICYCLE LANE (BETWEEN MOTOR VEHICLE AND BICYCLE LANES)



Source: <http://nacto.org/publication/urban-bikeway-design-guide/bike-lanes/buffered-bike-lanes/>

EXHIBIT 6-5: BUFFERED BICYCLE LANE (BETWEEN PARKING AND BICYCLE LANES)



Source: <http://nacto.org/publication/urban-bikeway-design-guide/bike-lanes/buffered-bike-lanes/>

6.2.3 Considerations at Intersections

Compact intersections where roads meet at (or nearly at) right angles are most functional for cyclists. Acute-angle intersections with three or four legs are less desirable because some turning movements can be made at higher speeds, which creates conflicts with bicyclists traveling straight. Also, trucks turning on obtuse angles have blind areas on their right sides. However, the presence of an acute-angle intersection along a candidate bicycle route should not disqualify it from designation if no convenient alternative route is available.

Tennessee traffic laws specify that both the approach to a right turn and the turn itself must be made “in the rightmost lane and as close as practicable to the curb or edge of road.” This applies to both motorists and bicyclists. Therefore, motorists should enter the adjacent bicycle lane to turn right. The motorist must yield to cyclists present in the bicycle lane prior to merging. Merging into the bicycle lane helps improve bicyclist safety by mitigating the risk for “right-hook” collisions between bicyclists and motorists. This is also the reason for dashed pavement markings along bicycle lanes approaching intersections.

6.2.4 Signing and Pavement Markings (Mainline and Intersections)

The MUTCD devotes an entire Chapter (Chapter 9) and 26 pages to traffic control for bicycle lanes. Signs and pavement markings are covered. The MUTCD should be referenced for guidance on signing and pavement marking guidance and recommendations. The current version of the MUTCD is available for download at:

<http://mutcd.fhwa.dot.gov/pdfs/2009r1r2/mutcd2009r1r2edition.pdf>.

Additionally, TDOT Standard Drawings T-M-11 through T-M-14 should be referenced for additional guidance concerning signing and pavement markings for bicycle lanes:

- T-M-11: SIGNING AND PAVEMENT MARKINGS FOR BICYCLE LANES OR ROUTES
- T-M-12: SIGNING AND PAVEMENT MARKINGS FOR BICYCLE LANES ON URBAN ROADWAYS
- T-M-13: SIGNING AND PAVEMENT MARKINGS FOR BICYCLE LANES
- T-M-14: SIGNING AND PAVEMENT MARKINGS FOR BICYCLE LANES AT INTERSECTIONS

Extra attention should be paid at intersections, as those often have complex requirements. This is an area that is quickly evolving, with FHWA issuing many interim approvals and clarification memorandums. For example, FHWA issued a memorandum on January 5, 2017 clarifying that it is acceptable to extend bicycle lane dotted line pavement marking extensions through intersections. The memorandum can be downloaded at:

<http://mutcd.fhwa.dot.gov/resources/policy/tcdstatusmemo/index.htm>.

Examples of typical bicycle lane treatments at intersections are shown in Exhibit 6-6 through Exhibit 6-8.

EXHIBIT 6-6: BICYCLE LANE TREATMENT AT A RIGHT TURN ONLY LANE

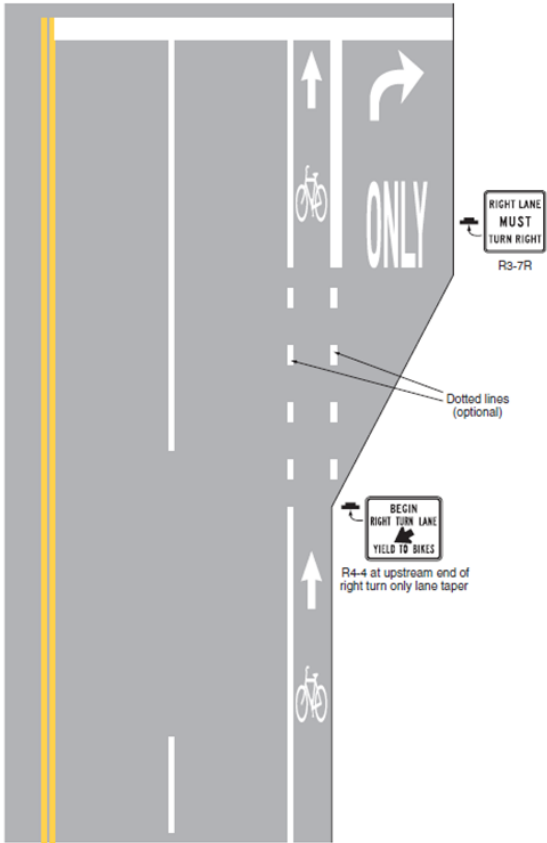

Source: MUTCD Figure 9C-4

EXHIBIT 6-7: BICYCLE LANE TREATMENT AT PARKING LANE INTO A RIGHT TURN ONLY LANE

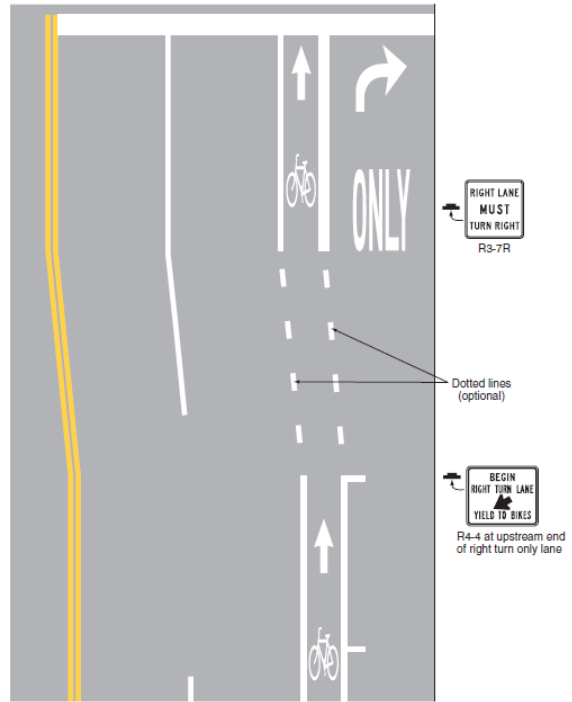

Source: MUTCD Figure 9C-5

EXHIBIT 6-8: PAVEMENT MARKINGS FOR BICYCLE LANES ON A TWO-WAY STREET

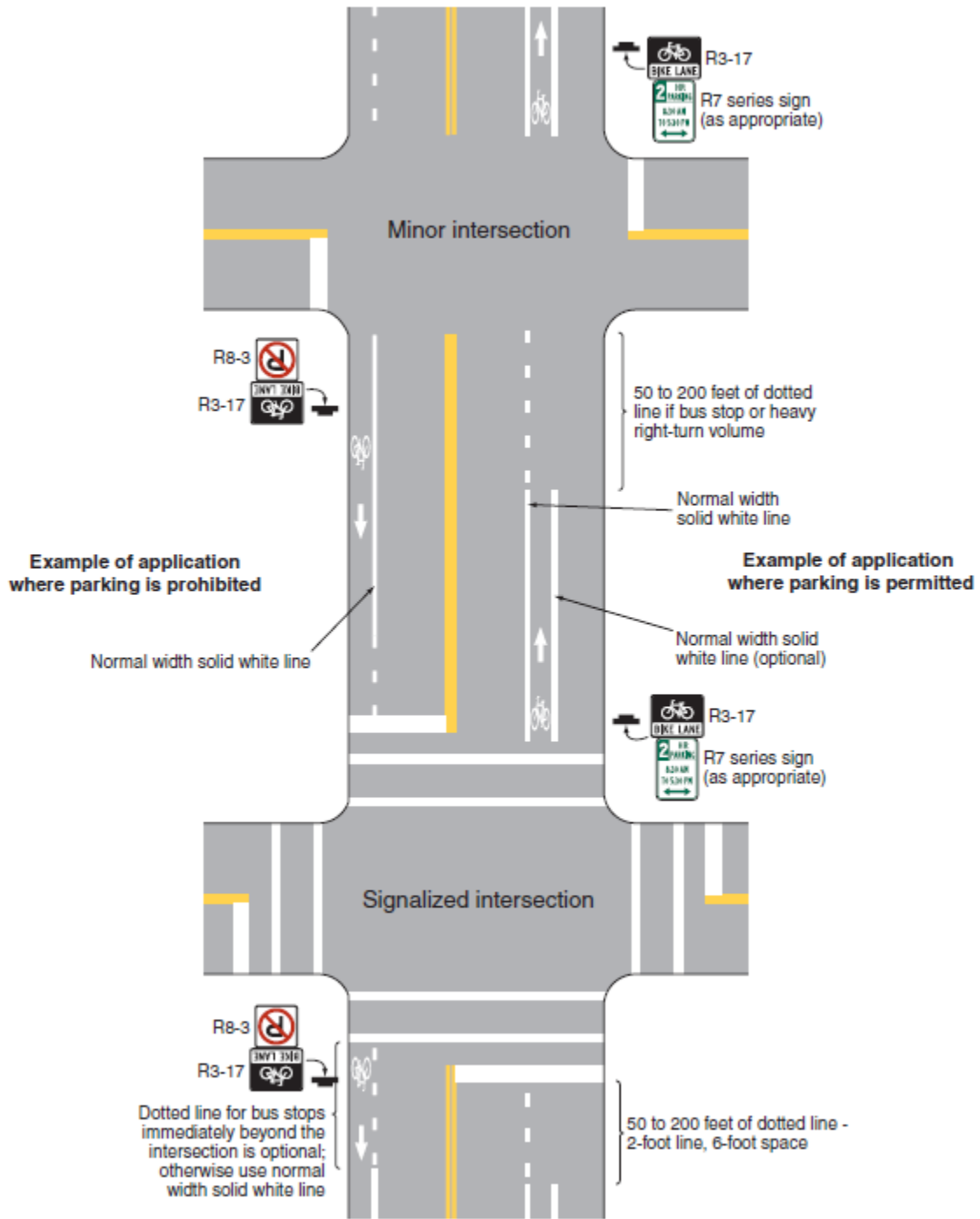

Source: MUTCD Figure 9C-6

FHWA issued an Interim Approval (IA-14) on April 15, 2011 for the optional use of green colored pavement in designated bicycle lanes and in extensions of designated bicycle lanes through intersections and other traffic conflict areas. Green colored pavement may be installed within bicycle lanes as a supplement to the other pavement markings that are required for the designation of a bicycle lane. IA-14 can be downloaded at:

http://mutcd.fhwa.dot.gov/resources/interim_approval/ia14/ia14grnpmbiketlanes.pdf

Exhibit 6-9 provides an example of a bicycle lane treatment with colored pavement markings.

EXHIBIT 6-9: GREEN PAVEMENT MARKINGS



Source: NACTO Urban Bikeway Design Guide

The FHWA also issued an Interim Approval (IA-18) on October 12, 2016 for the optional use of intersection bicycle boxes. The intersection bicycle box is a designated area on the approach to a signalized intersection, between an advance stop line and the intersection stop line, intended to provide bicyclists a space in which to wait in front of stopped motor vehicles during the red signal phase so that they are more visible to motorists at the start of the green signal phase. Positioning bicyclists in the center of the appropriate lane allows them to turn from a location where they are more visible to surrounding traffic, can increase the visibility of stopped bicycle traffic at an intersection, can reduce conflicts between bicyclists and turning motor vehicles, can help mitigate intersection right-turn conflicts, and can help group bicyclists together to clear intersections more quickly.

Bicycle boxes should be used with caution where a right-turn only lane is not present to the right of the bicycle lane or where motorized right turns are not prohibited. Right-turning motorists may stay to the left of the bicycle lane, instead of merging into the bicycle lane, and turn right from this incorrect location. This creates a right-hook crash threat for cyclists who arrive during the green interval. When motorists properly merge into the bicycle lane to turn right, access to the bicycle box during the red interval is often blocked. The box then has little value as cyclists cannot use it.

Bike boxes should typically not be used on multilane approaches to an intersection where the inside lane is a shared through/left-turn lane. A cyclist in this inside lane awaiting a gap in oncoming traffic to turn left may not be noticed by an approaching motorist from the rear wishing to continue straight through the intersection, creating a collision risk.

Exhibit 6-10 shows a bicycle box that is supplemented with green pavement markings. Exhibit 6-11 shows a bicycle box design layout with recommended right turn-lane. IA-18 and its design guidance attachments can be downloaded at:

http://mutcd.fhwa.dot.gov/resources/interim_approval/ia18/ia18.pdf

http://mutcd.fhwa.dot.gov/resources/interim_approval/ia18/ia18attachments.pdf

EXHIBIT 6-10: BICYCLE BOX (WITH GREEN PAVEMENT MARKINGS)



EXHIBIT 6-11: BICYCLE BOX LAYOUT

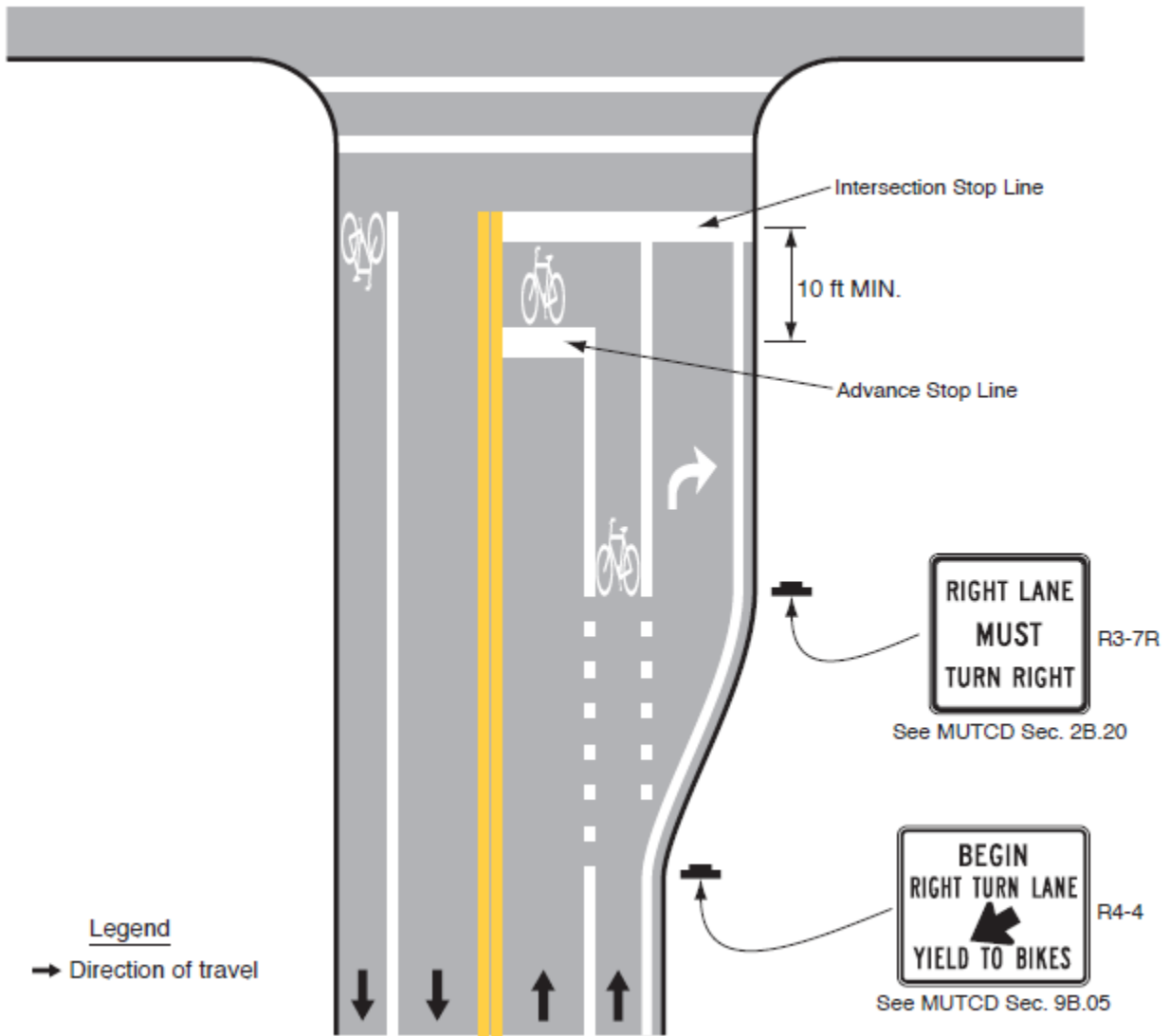

Source: FHWA IA-18

6.3 SEPARATED BICYCLE LANES/CYCLE TRACKS

A separated bicycle lane, also referred to as a cycle track or protected bicycle lane, is an exclusive facility for bicyclists that is located within or directly adjacent to the roadway and is physically separated from motor vehicle traffic with a curb, median, or other vertical element. On-street parking may supplement physical separation. Separated bicycle lanes enhance safety for all street users, encourage more bicycling, and are typically preferred by bicyclists and motorists alike. Examples of cycle tracks are provided in Exhibit 6-12 through Exhibit 6-14.

Separated bicycle lane design guidelines have recently been introduced in FHWA's *Separated Bike Lane Planning and Design Guide* to communicate best practices, advance design guidance, and encourage flexible solutions to bicycle mobility. The signing and pavement markings associated with separated bicycle lanes must be compliant with the MUTCD.

Raised medians/curbs are generally preferred to create the physical separation between the bicycle lanes and motor vehicle lanes. However, they are costly and typically impact drainage. Therefore, they are most commonly installed as part of a full street reconstruction project. Delineator posts or other lower-cost vertical elements can be ideal for retrofit projects. Depending on the project, street buffer widths and vertical element spacing can vary.

Separated bicycle lanes may be one-way, either in the direction of vehicle travel or contra-flow, or two-way. Preferred widths range from seven feet for one-way operation to 12 feet for two-way operation, exclusive of the street buffer. Wider separated bicycle lanes accommodate greater volumes of bicyclists. Narrower widths are sometimes used in constrained locations. However, this may inhibit passing and side-by-side riding, which are important to providing a comfortable bicycling environment that appeals to all ages and bicycling abilities. Please refer to Section 6.2.1 *Bicycle Lane Design Criteria* for guidance on minimum widths for bicycle lanes.

EXHIBIT 6-12: CYCLE TRACK (RETROFIT WITH DELINEATORS)

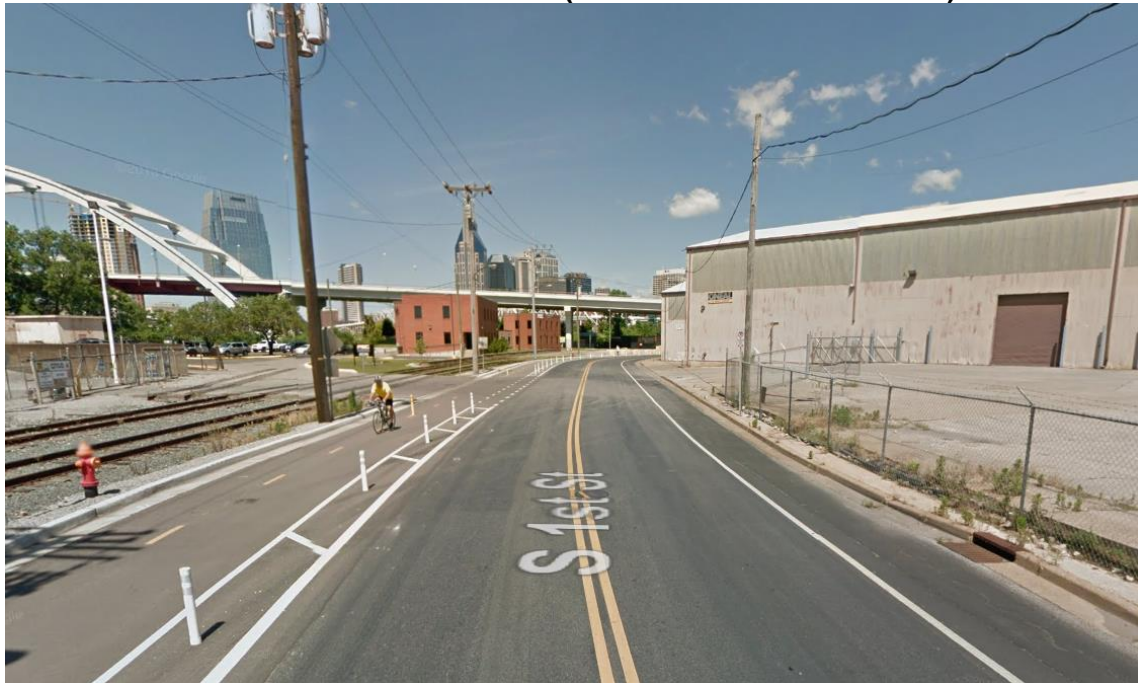

Source: Google Maps

EXHIBIT 6-13: CYCLE TRACK WITH CURB/MEDIAN PHYSICAL SEPARATION



Source: Mark H. Zwoyer via FHWA Separated Bike Lane Planning and Design Guide

EXHIBIT 6-14: ONE-WAY CYCLE TRACK WITH ON-STREET PARKING



Source: NYCDOT via FHWA Separated Bike Lane Planning and Design Guide
Note: See Section 7.1 for guidance on detectable warning surfaces.

6.4 SHARED-USE PATHS

Please refer to Section 7.6 *Pedestrian Facilities, Shared-Use Paths* for guidance on shared-use paths that are designed to serve both bicycles and pedestrians.

6.5 BICYCLE SIGNALS

Agencies across the United States are showing an increased interest in bicycle signal faces, and many of them have submitted requests to FHWA to experiment with bicycle signal faces. During the past five years, FHWA has approved experiments with bicycle signal faces for a variety of State, county and local governmental agencies. In these experiments, the bicycle signal face is a traffic control device that is being used to provide for separate control of the bicycle movement and address one or more of the following situations:

1. Bicyclist non-compliance with the previous traffic control;
2. Provide a leading or lagging bicycle interval;
3. Continue the bicycle lane on the right-hand side of an exclusive turn lane that would otherwise be in non-compliance with Paragraph 6 of Section 9C.04;
4. Augment the design of a segregated counter-flow bicycle facility;
5. Provide an increased level of safety by facilitating unusual or unexpected arrangements of the bicycle movement through complex intersections, conflict areas, or signal control.

FHWA lists several criteria in Memorandum Interim Approval 16 (IA-16): *MUTCD- Interim Approval for Optional Use of a Bicycle Signal Face*, which must be met for a state or municipality to be granted permission for the optional use of bicycle signal faces. IA-16 can be downloaded at:

https://mutcd.fhwa.dot.gov/resources/interim_approval/ia16/

6.6 SECTION 6.0 SOURCES

1. American Association of State Highway and Transportation Officials. (2012). *Guide for the Development of Bicycle Facilities, 4th Edition*. Washington, D.C.
2. Broward County, FL MPO (2012). *Broward Complete Streets Guidelines*. Broward County, FL.
3. Federal Highway Administration. (2016). *Applying Performance-Based Practical Design Methods to Complete Streets: A Primer on Employing Performance-Based Practical Design and Transportation Systems Management and Operations to Enhance the Design of Complete Streets*. Washington, D.C.
4. Federal Highway Administration. (2016). *Achieving Multimodal Networks, Applying Design Flexibility & Reducing Conflicts*. Washington, D.C.
5. Federal Highway Administration. (2012). *Manual on Uniform Traffic Control Devices*. Washington, D.C.
6. Federal Highway Administration. Memorandum IA-16 *Interim Approval for Optional Use of a Bicycle Signal Face*. Retrieved March 27, 2017 from, https://mutcd.fhwa.dot.gov/resources/interim_approval/ia16/
7. Federal Highway Administration. (2015). *Separated Bike Lane Planning and Design Guide*. Washington, D.C.
8. Governors Highway Safety Association. (2014). *Spotlight on Highway Safety, Bicyclist Safety*. Retrieved November 15, 2016 from, http://www.ghsa.org/html/files/pubs/spotlights/bikes_2014.pdf.
9. National Association of City Transportation Officials. (2014). *Urban Bikeway Design Guide*. New York, NY.
10. National Cooperative Highway Research Program. (2011). *Revising the AASHTO Guide for the Development of Bicycle Facilities*. Report 15-37. The National Academies of Sciences, Engineering, and Medicine, Washington, D.C.
11. Tennessee Department of Transportation. (2013). *Tennessee Traffic Laws Relating to Bicycles, A Handbook for Motorists and Bicyclists*. Nashville, TN.

7.0 PEDESTRIAN FACILITIES

Distance is the primary factor in the initial decision to walk. Most pedestrian trips are 0.25 miles or less, with 87 percent of walking trips less than one mile. Walking trips as part of a commute are longer; the average walking commute length is approximately one mile. Most people are willing to walk five to 10 minutes at a comfortable pace to reach a destination. Since approximately 25 percent of all transportation trips are one mile or less in distance (30 percent in urban areas), walking has the potential to serve a significant portion of trips. Pedestrians walk for convenience, personal health, or out of necessity. They often prefer greater separation from the roadway, require additional time to cross roadways, and are the most vulnerable of all roadway users.

Under Tennessee law, pedestrians have the right-of-way at all intersections and driveways. However, pedestrians must act responsibly, using pedestrian signals and sidewalks where they are available. Tennessee pedestrian laws can be viewed at:

<http://www.tn.gov/tdot/article/bikeped-pedestrian-laws>

7.1 CURB RAMPS, CROSS WALK MARKINGS, AND DETECTABLE WARNING SURFACES

To the maximum extent feasible, a curb ramp, blended transition, or a combination of curb ramps and blended transitions shall connect the pedestrian facility at each pedestrian street crossing. Parallel curb ramps have a running slope that is in-line with the direction of sidewalk travel and lowers the sidewalk to a level turning space where a turn is made to enter the pedestrian street crossing. Blended transitions are raised pedestrian street crossings, depressed corners, or similar connections between the pedestrian access route at the level of the sidewalk and the level of the pedestrian street crossing that have a grade of 5 percent or less. In general, perpendicular design curb ramps are preferable when geometric conditions allow their use. Typically, two curb ramps must be provided at each street corner. In alterations where existing physical constraints prevent two curb ramps from being installed at a street corner, a single diagonal curb ramp or blended transition is permitted at the corner. Examples of curb ramp designs are provided in Exhibit 7-1 through Exhibit 7-3. Additional information can be found in TDOT Standard Drawings RP-H-3 through RP-H-9, and in the PROWAG.

When a project's limits begin or end an intersection, all approaches to the intersection must be upgraded with similar multimodal features such that pedestrians and cyclists can traverse the intersection. Where curb ramps are installed, they must be installed in all quadrants of an intersection that are connected by pedestrian facilities. When crosswalks are present, they should typically be placed in all quadrants of the intersection.

EXHIBIT 7-1: PERPENDICULAR CURB RAMP

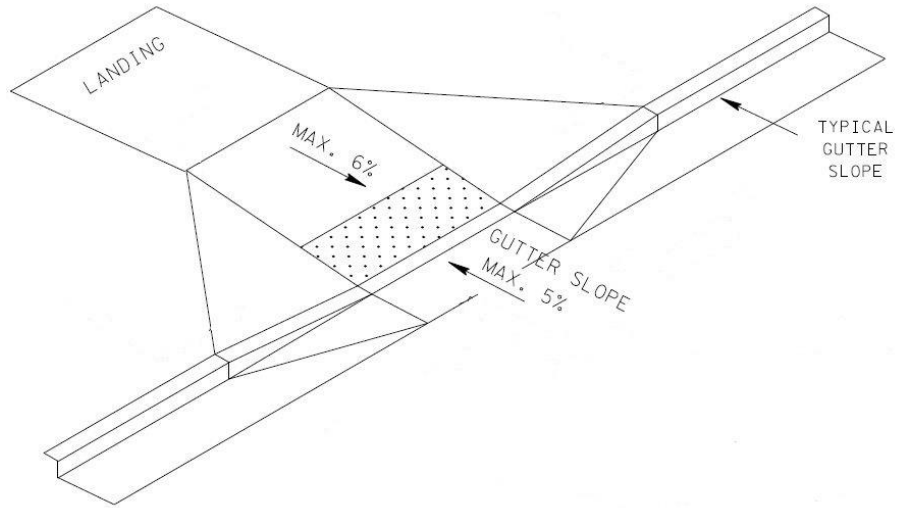

Source: TDOT Standard Drawing RP-H-4

EXHIBIT 7-2: PARALLEL CURB RAMP

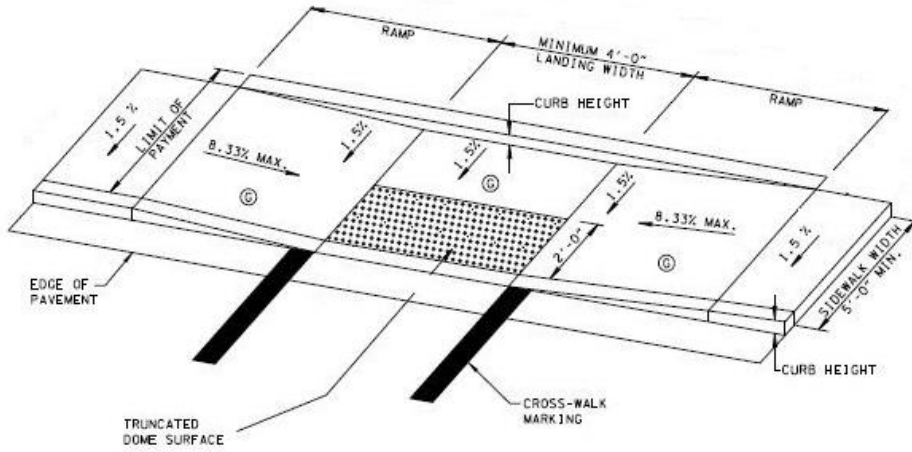

Source: TDOT Standard Drawing RP-H-5

EXHIBIT 7-3: BLENDED TRANSITION

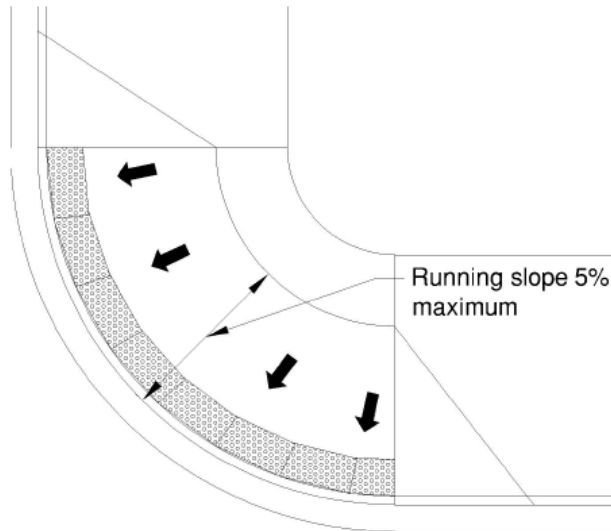

Source: PROWAG, pg. 81.

Marked crosswalks are a place designated for pedestrians to cross a road. Marked crosswalks are designed to keep pedestrians together where motorists can see them, and where they can cross more safely across the flow of vehicular traffic. Marked crosswalks can be one of two pavement marking configurations: Longitudinal, which is sometimes referred to as "continental", or transverse. Longitudinal markings should be used where added emphasis is needed for the crosswalk, or where local preference dictates. Longitudinal and transverse crosswalks are shown in Exhibit 7-4.

EXHIBIT 7-4: LONGITUDINAL AND TRANSVERSE CROSSWALKS

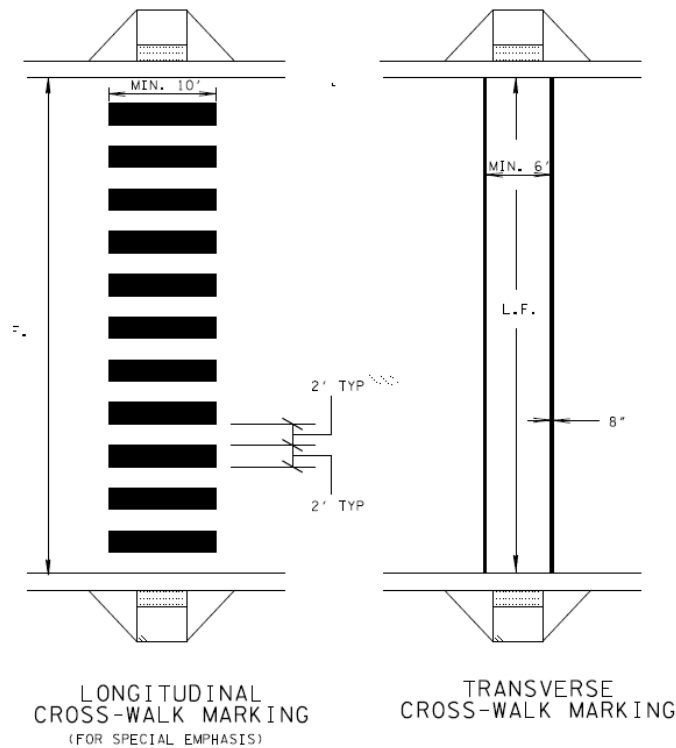

Source: TDOT Standard Drawing T-M-4

Pedestrian pushbuttons and signals shall be used where there are existing or proposed marked crosswalks at signalized intersections. On new signal installations, or where an existing signal is modified, the pedestrian pushbuttons and signals shall have audible guidance to meet the accessibility requirements in the PROWAG. If marked crosswalks are not present, and will not be added, accessible pedestrian signals (APS) are not required. The installation of APS are also not required at existing crosswalk locations if the existing pedestrian signals and pushbuttons are in working order and do not need to be modified for other reasons.

On pedestrian facilities, detectable warning surfaces indicate the boundary between pedestrian and vehicular routes where there is a flush connection. They serve the need of people with vision impairments. Typical placement locations include at curb ramps and pedestrian refuge islands. However, PROWAG guidance notes that detectable warning surfaces are not required at cut-through pedestrian refuge islands that are less than six feet in length because detectable warning surfaces must extend two feet (minimum) on each side of the island and be separated by a minimum two-foot length of island without detectable warning surfaces. Installing detectable warning surfaces at cut-through pedestrian islands that are less than six feet in length would compromise the effectiveness of detectable warning surfaces. Where a cut-through pedestrian refuge island is less than six feet in length and the pedestrian street crossing is signalized, the signal should be timed for a complete crossing of the street.

Detectable warning surfaces should also not be provided at crossings of residential driveways since the pedestrian right-of-way continues across residential driveway aprons. However, where commercial driveways are provided with yield or stop control, detectable warning surfaces should be provided at the junction between the pedestrian route and the vehicular route.

Detectable warning surfaces shall contrast visually with the adjacent gutter, street, or pedestrian facility surface; either light-on-dark or dark-on-light. On TDOT projects, detectable warning surfaces are bright yellow. Detectable warning surfaces shall extend two feet (minimum) in the direction of pedestrian travel. At curb ramps, detectable warning surfaces shall extend the full width of the ramp. Examples of TDOT-compliant detectable warning surfaces are shown in Exhibit 7-5.

EXHIBIT 7-5: TDOT-COMPLIANT DETECTABLE WARNING SURFACES



Example Blended Transition



Example Parallel Curb Ramp



Example Mid-Block Crossing

7.2 SIDEWALK DESIGN WITHOUT CURB

The majority of sidewalks are along streets with curb. However, sidewalks can and do exist along streets without curb, typically in suburban or rural areas. When the street does not have curb, the sidewalk should be placed a minimum of five feet measured from the outside edge of shoulder to the inside edge of the sidewalk. If a roadside ditch is present, the sidewalk should be placed on the far side of the ditch from the roadway for added lateral separation.

When the sidewalk is parallel to a roadway with a design speed of 50 mph or more, greater lateral offset is recommended from the edge of the travel lane. Curb is typically not present on streets with design speeds of 50 mph or more. A minimum distance of 12 feet, measured from the outside edge of shoulder to the inside edge of the sidewalk, is recommended. If the sidewalk is located within the clear zone of the roadway, consideration should be given to a crash-worthy barrier in order to protect the users of the path. An example of a sidewalk located along a roadway segment without curb is provided in Exhibit 7-6.

The design guidance provided in Section 7.3 *Sidewalk Design with Curb* also applies to sidewalk design without curb. For example, the cross slope of the sidewalk should be at least one percent, but no more than two percent. The two percent maximum is a requirement of the ADA and PROWAG for pedestrian access routes. Cross slopes less than one percent can lead to ponding and mud accumulation on the sidewalk. Additionally, the graded areas adjacent to the sidewalk must allow water to drain off and away from the sidewalk.

EXHIBIT 7-6: SIDEWALK WITHOUT CURB



Source: Pedestrians.org

7.3 SIDEWALK DESIGN WITH CURB

Most sidewalks are located along streets with curb. As shown in Exhibit 7-7 and Exhibit 7-8, a street's public right-of-way can be broken into five general areas: The frontage zone, the throughway zone, the furnishing zone, the edge zone, and the roadway zone. The primary uses for each of these zones is listed in Exhibit 7-7. It should be noted that in suburban or rural areas, the frontage zone is likely to include slopes and easements instead of building frontage.

EXHIBIT 7-7: PUBLIC RIGHT-OF-WAY ZONES - TABLE

Sidewalk Area			Roadway	
Frontage Zone	Throughway Zone	Furnishing Zone	Edge Zone	Roadway
<ul style="list-style-type: none"> • Concrete paving • Building entries • Store signage and merchandising • Public seating • Outdoor dining • Landscaping/trees • Slopes and easements 	<ul style="list-style-type: none"> • Concrete paving • Pedestrian Access Route - ADA and PROWAG Compliant 	<ul style="list-style-type: none"> • Concrete paving • Utilities • Landscaping • Grass strip • Public seating • Bicycle racks • Transit stops • Pedestrian – oriented signage • Waste and recycling receptacles • Newsracks • Parking Meters and pay stations • Roadway signage 	<ul style="list-style-type: none"> • Curb • Stormwater management 	<ul style="list-style-type: none"> • Bicycle lanes • Motor vehicle travel lanes
			<p>Key: Pedestrian and Bicycle Oriented Vehicular Oriented</p>	

Source: Adapted from City of Los Angeles

EXHIBIT 7-8: PUBLIC RIGHT-OF-WAY ZONES - IMAGE

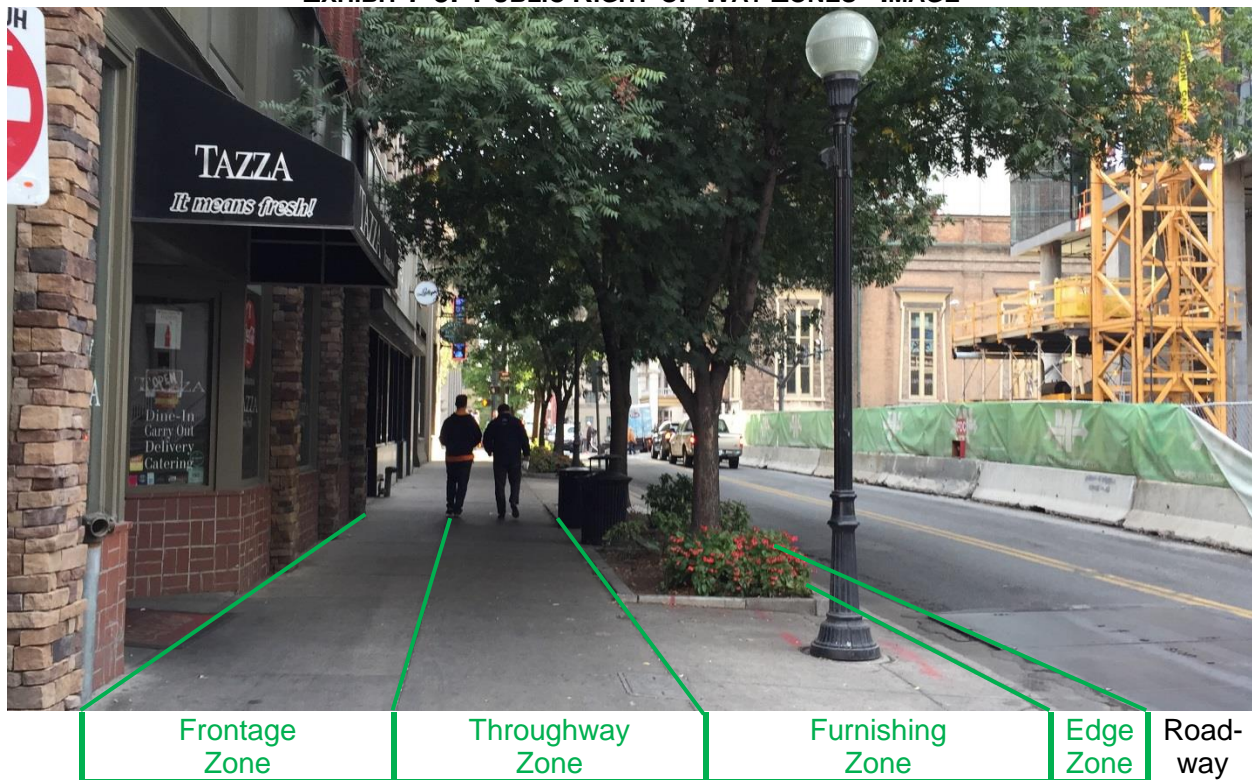

Information concerning edge, furnishing, throughway, and frontage zones of a sidewalk are provided starting below.

7.3.1 Edge Zone

The edge or curb zone provides physical vertical separation between moving vehicles and pedestrians, as well as accommodating stormwater runoff.

7.3.2 Furnishing Zone

This zone has five general uses/benefits: to serve as a pedestrian buffer, as a planting strip/location for landscaping, as a location for street furniture and mailboxes, as an aid to create ADA-compliant driveway crossings of the sidewalk, and as a space to locate utilities. The furnishing zone is placed between the edge zone and the throughway zone. To serve the purposes listed, a minimum of three feet in width is recommended between the curb and a paved sidewalk. In contexts where higher motor vehicle speeds are found, greater separation is desirable. It is worth noting that the furnishing zone can be paved and used as an extension of the throughway. However, unlike the throughway, a paved furnishing zone does not have to meet ADA requirements.

Pedestrian Buffer

The buffering of the streetside from vehicle traffic provides pedestrian comfort along roadways. Buffers create a visual and sound barrier between pedestrian and moving traffic. When present, on-street parking and/or bicycle lanes provide a buffer between pedestrians on the sidewalk and moving traffic. For streets without on-street parking, the minimum width recommended is three feet and the desirable width of the furnishing zone as a buffer for pedestrians is six feet.

Planting Strip/Landscaping

Landscaping is typically located in the furnishing zone of the streetside. Vegetation, especially trees, helps to visually break-up the concrete and asphalt surfaces of the roadway and improve a roadside's aesthetics. Trees provide shade from the sun, intercept stormwater, and buffer pedestrians from passing vehicle traffic. Ground cover, grasses, and shrubs are appropriate supplements to add character along residential streets.

If a continuous canopy of trees is desired, space street trees between 15 and 30 feet on center, depending upon species. In more urban zones and along street segments with predominantly commercial ground floor uses, trees should be planted in tree wells covered by tree grates to maximize surface area for pedestrian circulation. The width of the landscaped strip should be at least five feet (preferred width is eight feet) to support healthy tree growth.

Street Furniture & Mailboxes

Street furniture placed along a sidewalk encourages walking. Street furniture such as seating, trash receptacles, and drinking fountains provide a functional service to pedestrians and convey to motorists that pedestrians are likely to be present.

In residential areas, mailboxes are placed in the furnishing zone area. Planting strips allow for mailboxes to be placed more easily, without interfering with the throughway zone, and without requiring their supports to be mounted in the concrete sidewalk. Sidewalks that directly abut the curb often have to have mailboxes turned parallel with the road so that they do not interfere with the throughway.

As discussed in Section 7.3.3 *Throughway Zone*, street furniture and mailboxes must provide a clear pedestrian throughway of at least five feet.

Driveway Slope Benefit

To meet ADA requirements, the throughway’s cross slope cannot exceed two percent. The two percent maximum cross-slope requirement also applies where the throughway crosses driveways. A best practice is to have a furnishing zone at least four feet wide in front of the sidewalk so that the sloped driveway apron can be placed without interfering with the sidewalk cross-slope (see Exhibit 7-9).

Place to locate Utilities

Refer to Section 12.1 *Utilities* for information concerning utility placement.

Furnishing Zone Summary

Minimum recommended widths for various purposes of the furnishing zone are summarized in Exhibit 7-10.

EXHIBIT 7-9: DRIVEWAY RELATIONSHIP TO FURNISHING ZONE

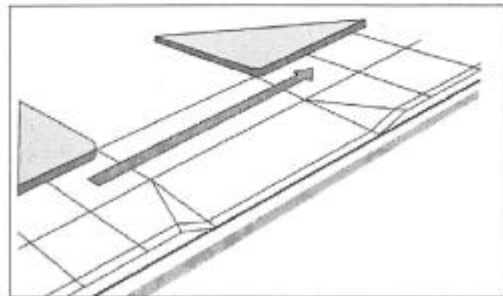
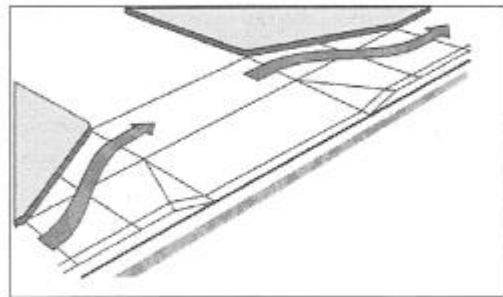
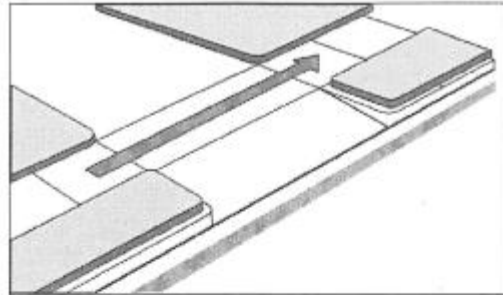

Source: ITE Designing Walkable Urban Thoroughfares: A Context Sensitive Approach

EXHIBIT 7-10: MINIMUM FURNISHING ZONE WIDTH SUMMARY

Purpose	Dimension
To serve as a pedestrian buffer	3 ft.
To locate mailboxes	3 ft.
To benefit driveway slopes	4 ft.
To plant trees	5 ft.
To place street furniture	Varies
To place utilities	Varies

7.3.3 Throughway Zone

The throughway zone is for pedestrian movement. Many of the dimensional requirements of the throughway zone are listed in the U.S. Access Board's *Proposed Accessibility Guidelines for Pedestrian Facilities in the Public Right-of-Way*, commonly referred to as the PROWAG (*Public Right-of-Way Accessibility Guidelines*). The Access Board has proposed accessibility guidelines for the design, construction, and alteration of pedestrian facilities in the public right-of-way. The guidelines require a pedestrian access route be provided within sidewalks and other pedestrian circulation paths located in the public right-of-way. A pedestrian access route is defined as a continuous and unobstructed path of travel provided for pedestrians with disabilities within or coinciding with a pedestrian circulation path. While the PROWAG has not yet been adopted nationally as standard, TDOT has adopted it, and accessibility in public rights-of-way is required by the ADA.

If a shoulder is intended to serve as part of a pedestrian access route, then the shoulder must meet PROWAG requirements for pedestrian walkways. So that a wheelchair user does not have to enter the roadway to pass another user, shoulders used to accommodate pedestrians should be at least five feet wide to maintain a consistent shoulder width. Additional guidance is provided in Section 4.5 *Shoulders*.

Throughway zones that provide direct routes, with few meanders, are typically preferred by those with visual impairments. Additional guidance concerning the throughway zone's width, cross slope, and grade is provided below.

Width

The throughway zone is intended for pedestrian travel. Its width should vary by context and the activity of the adjacent land use. A minimum continuous and clear pedestrian throughway zone width of five feet must be maintained. In constrained conditions, it is permissible to have a clear width of four feet, if passing areas five feet in width are provided no more than 200 feet apart. This minimum width of four feet must be maintained around items commonly placed within the sidewalk area, including sign posts, luminaire supports, signal poles, etc. In commercial areas, the minimum recommended throughway zone is six feet, due to the anticipated higher level of pedestrian activity.

Cross slope

To allow sufficient drainage, walkways should have a cross slope of between one and two percent. The two percent maximum is a requirement of the ADA and PROWAG for pedestrian access routes. The two percent maximum cross slope applies across driveways. Incorporating a furnishing zone at least four feet wide improves the sidewalk's design across driveways. For additional information on driveways and furnishing zones, refer to Section 7.3.2.

A cross slope of less than one percent would not shed water after a rain event. Pondered water can become slippery, obscure surface discontinuities, freeze in cold weather, and degrade the sidewalk, increasing the need for maintenance. Sidewalks typically slope and drain towards the roadway, where the stormwater is collected in the roadway's curb and gutter network. In unique situations when needed, the sidewalk may slope and drain away from the roadway. In these instances, the designer must ensure the stormwater will not pond and collect on the throughway zone.

Grade

Longitudinal grades, which run parallel to the pedestrian path of travel, can be challenging for pedestrians if they are too steep. PROWAG requires that longitudinal grades not exceed five percent for pedestrian access routes outside of a street or highway right-of-way and for pedestrian access routes within street crossings. Pedestrian access routes adjacent to roadways with grades steeper than five percent may match, but shall not exceed, the general grade of the roadway.

7.3.4 Frontage Zone

The frontage zone is the area adjacent to the property line that may be defined by a building facade, landscaping, fence, or screened parking area. Generally, pedestrians do not feel comfortable moving at a full pace directly along a building facade or wall. The frontage zone provides distance between the throughway and any potential structure, including a building facade, which may be located on the adjacent property. The width of the frontage zone can vary to accommodate a variety of activities associated with adjacent uses.

In urban areas, the frontage zone provides a clear area between the throughway and building frontages and provides space for access, swinging doors, people to gather, etc. Some communities choose to provide a wide space in this zone to accommodate street vendors or outdoor dining. Even where no buildings front the street, it is desirable to have 18 inches (1.5 feet) of space between the back of the throughway (sidewalk) and the property line. This practice allows for construction and maintenance of the sidewalk and ensures that vertical elements such as fences are not placed directly adjacent to the sidewalk, which could narrow the effective width of the sidewalk.

Sidewalk businesses or other business activities should be conducted in the frontage zone. Private furnishings permitted in the frontage zone may include seating and tables, portable signage, and merchandise displays. Overhanging elements such as awnings, store signage, and bay windows may occupy this zone and extend over the throughway zone. Elements overhanging the throughway zone require a vertical clearance of at least six feet and eight inches (80 inches).

7.4 CROSSWALKS AT INTERSECTIONS

Crosswalks should be designed to minimize the walking distance to cross the intersection. The geometric design of the intersection should follow the applicable guidance in Section 4.0 *Roadway Design Elements*. This could include reducing lane widths, minimizing turning radii, and limiting the use of turn lanes. Pavement markings and curb ramp placement also have a large impact on crossing distances. Exhibit 7-11 provides an example of poor crosswalk placement. Because the crosswalks crossing the minor street are parallel with the main street, the crosswalks are 140 feet long. By making them perpendicular to the minor street, they could have been reduced to 60 feet. This would require relocating the stop lines on the minor street approaches, and possibly supplemental signal heads for the minor street approaches. These minor adjustments would have made this intersection much easier for pedestrians to cross. The guidance in the MUTCD must be followed, but there likely was a better solution to accommodate pedestrians and vehicles alike within the allowable requirements.

EXHIBIT 7-11: POOR CROSSWALK EXAMPLE

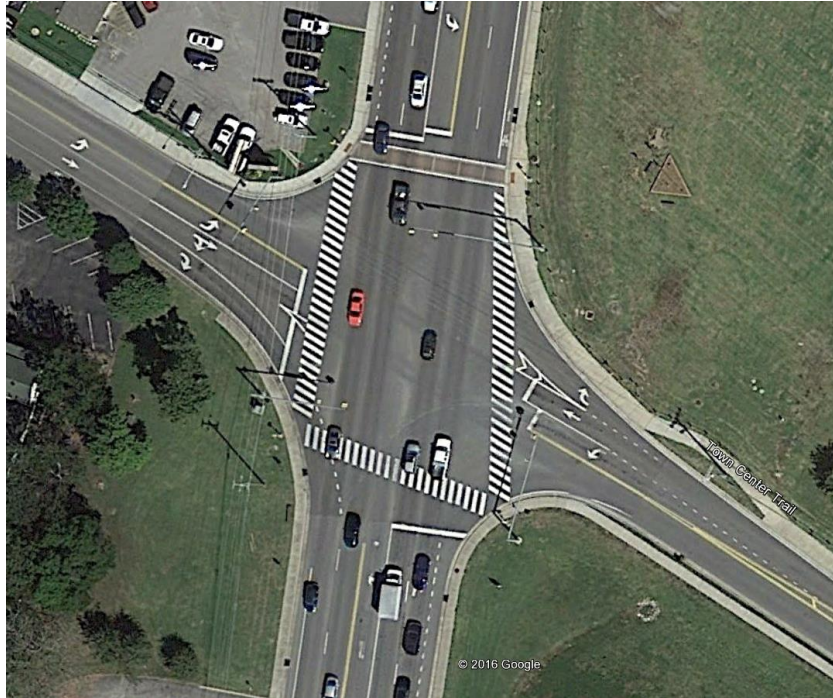

Source: Google Earth, Mt. Juliet Road at Division Street, Mt. Juliet, TN

7.4.1 Curb Extensions/Bulb-Outs

On streets with on-street parking, curb extensions can be used to extend the sidewalk or curb line into the parking lane, which reduces the effective street width at the intersection. Curb extensions can:

- Reduce the crossing distance of pedestrians;
- Improve the sight distance and sight lines for both pedestrians and motorists;
- Create adequate space for curb ramps and landings where the existing sidewalk space is narrow;
- Provide additional storage space for pedestrians waiting to cross; and
- Prevent parked cars from encroaching into the crosswalk area.

In general, curb extensions should extend the width of the parking lane, with the face of curb approximately one foot from the edge line of the through travel lane. Curb extensions may not be needed or desirable on every leg of an intersection if the street leg is narrow, parking is not permitted, or the curb extension would interfere with a bicycle lane or the ability of the Design Vehicle to negotiate a right turn. Storm drainage from the street must also be considered by the designer to ensure ponding does not occur. Low-level landscaping, including planting strips, is recommended on curb extensions to provide alignment cues for pedestrians with vision impairments and to increase the visibility of the extension to approaching motorists. Curb extensions are not typically appropriate at high-speed rural intersections or where channelized right turns are warranted.

7.4.2 Median Refuge Islands at Intersections

Refer to Section 4.8 *Medians* for guidance on dimensions of median refuge islands.

7.4.3 Pedestrian Considerations at Roundabouts

The lower speeds and shorter crossing distances associated with roundabouts with single-lane entries and exits are desirable for non-motorized users. Pedestrian crossings at roundabouts are typically uncontrolled, relying on the design of the roundabout to create low motor vehicle speeds. Because roundabouts use splitter islands to divide entering and exiting motor vehicle traffic on each leg, pedestrians only have to cross one direction of traffic at a time. Crosswalks should be placed at least one car length before the yield line at the roundabout entrance.

Providing safer crossings for pedestrians with vision impairments is challenging at roundabouts. At signalized intersections, these pedestrians often rely on accessible pedestrian signals to determine where and how to cross. Roundabouts do not directly interrupt flow and typically do not have signal control. Walking across roundabouts with multilane entries and/or exits creates additional difficulties for the visually impaired, and crosswalk enhancements may be needed. The designer should be familiar with the crosswalk design requirements in the MUTCD and the PROWAG. For example, PROWAG requires the use of High-Intensity Activated Crosswalk (HAWK) Pedestrian Hybrid Beacons (PHBs) to assist the visually impaired when crossing an approach to a multilane roundabout. PHBs are not required by PROWAG or any other source for single-lane roundabout crossings. Additional guidance concerning accessible crossings at roundabouts can be found in NCHRP 674 *Crossing Solutions at Roundabouts and Channelized Turn Lanes for Pedestrians with Vision Disabilities*.

7.5 CROSSWALKS AT MIDBLOCK LOCATIONS

Pedestrians have a strong desire to cross streets at locations close to their intended path and they do not want to go out of their way to reach their destination. The frequency of roadway crossings, including midblock crossings, can significantly impact the distance required to walk to access destinations. Midblock crossings should be considered where intersection crossings are widely spaced and natural pedestrian paths exist. Examples include:

- Where a shared use path crosses a roadway,
- At a midblock transit stop,
- Where a high number of pedestrians are already crossing,
- Where a new development that will generate pedestrian crossing traffic is planned at a midblock location,
- Where a natural path exists between pedestrian traffic generators (such as a parking lot and an office building), and
- Near a school.

Pedestrians will typically cross at the types of locations listed above, regardless if there is a marked crosswalk or not. Midblock crashes are those that occur when a pedestrian attempts to cross a road at a midblock location. Pedestrians are considerably more likely to be killed at midblock locations than at intersections. Nearly 70 percent of pedestrian fatalities occurred at

midblock/non-intersection locations in 2011³. Vehicles are typically traveling at higher speeds at midblock locations than near intersections, which likely contributes to the high severity of midblock crashes. The goal of providing midblock crossings is to make these locations safer through design.

In areas with high pedestrian densities, crossings should be provided at midblock locations where intersection crossings are farther than 400 feet apart. In addition, crossings should be located at least 100 feet from minor side streets and major driveways to provide traffic turning onto the roadway ample time to notice and yield to a crossing pedestrian.

Midblock crossings should not be provided where the horizontal or vertical alignment of the roadway limits drivers' sight distance, view of the pedestrian approach to the crossing, or view of the crossing itself. Trees, shrubs, poles, signs, and other objects along the roadside should not limit a driver's view of the pedestrian approaches to the crossing and the crossing itself. On-street parking should be prohibited near the crossing because a pedestrian who steps into the road between parked cars can be blocked from the view of oncoming drivers. Providing street lighting at a midblock crossing is recommended to illuminate the crossing at night. At midblock crossings on multilane streets, the use of stop or yield lines, 30 to 50 feet in advance of the crosswalk, reduces the potential for pedestrian crashes. Median pedestrian refuge islands are recommended on multilane streets.

The MUTCD states "crosswalk lines should not be used indiscriminately." Before a crosswalk is installed at a midblock location, an engineering study should be completed and include several factors such as the number of lanes, distance to adjacent signalized intersections, pedestrian and vehicle volumes, and vehicle speeds.

At crossing locations with relatively high traffic volumes and speeds, as well as longer crossing distances, designers should consider enhanced crossing treatments (e.g., crossing island, signal, or signing) to supplement a marked crosswalk. FHWA's *Safety Effects of Marked Versus Unmarked Crosswalks at Uncontrolled Locations* recommends substantial crossing improvements be installed to supplement a marked crosswalk under any of the following conditions:

- Where the speed limit exceeds 40 mph.
- On a street with four or more lanes without a raised median or crossing island that has (or will soon have) an ADT of 12,000 or greater.
- On a street with four or more lanes with a raised median or crossing island that has (or soon will have) an ADT of 15,000 or greater.

Exhibit 7-12 provides guidance for when a location is a candidate for a midblock crosswalk (C), when a midblock crosswalk may be considered with additional pedestrian crossing enhancements (P), and when a midblock crosswalk should not be installed without additional enhancements (N). These additional enhancements could include median refuge islands (which reduce crossing distance along with increasing safety for pedestrians), raised crosswalks, and pedestrian signalization. For additional guidance, refer to the footnotes provided at the bottom of Exhibit 7-12.

³ National Highway Traffic Safety Administration. Traffic Safety Facts 2011 Data: Pedestrians. United States Department of Transportation.

EXHIBIT 7-12: RECOMMENDATIONS FOR INSTALLING MIDBLOCK CROSSWALKS

Roadway Type (Number of Travel Lanes and Median Type)	Vehicle ADT ≤ 9,000			Vehicle ADT >9,000 to 12,000			Vehicle ADT >12,000–15,000			Vehicle ADT > 15,000		
	Speed Limit**											
	≤ 48.3 km/h (30 mi/h)	56.4 km/h (35 mi/h)	64.4 km/h (40 mi/h)	≤ 48.3 km/h (30 mi/h)	56.4 km/h (35 mi/h)	64.4 km/h (40 mi/h)	≤ 48.3 km/h (30 mi/h)	56.4 km/h (35 mi/h)	64.4 km/h (40 mi/h)	≤ 48.3 km/h (30 mi/h)	56.4 km/h (35 mi/h)	64.4 km/h (40 mi/h)
Two lanes	C	C	P	C	C	P	C	C	N	C	P	N
Three lanes	C	C	P	C	P	P	P	P	N	P	N	N
Multilane (four or more lanes) with raised median***	C	C	P	C	P	N	P	P	N	N	N	N
Multilane (four or more lanes) without raised median	C	P	N	P	P	N	N	N	N	N	N	N

* These guidelines include intersection and midblock locations with no traffic signals or stop signs on the approach to the crossing. They do not apply to school crossings. A two-way center turn lane is not considered a median. Crosswalks should not be installed at locations that could present an increased safety risk to pedestrians, such as where there is poor sight distance, complex or confusing designs, a substantial volume of heavy trucks, or other dangers, without first providing adequate design features and/or traffic control devices. Adding crosswalks alone will not make crossings safer, nor will they necessarily result in more vehicles stopping for pedestrians. Whether or not marked crosswalks are installed, it is important to consider other pedestrian facility enhancements (e.g., raised median, traffic signal, roadway narrowing, enhanced overhead lighting, traffic-calming measures, curb extensions), as needed, to improve the safety of the crossing. These are general recommendations; good engineering judgment should be used in individual cases for deciding where to install crosswalks.

** Where the speed limit exceeds 64.4 km/h (40 mi/h), marked crosswalks alone should not be used at unsignalized locations.

*** The raised median or crossing island must be at least 1.2 m (4 ft) wide and 1.8 m (6 ft) long to serve adequately as a refuge area for pedestrians, in accordance with MUTCD and American Association of State Highway and Transportation Officials (AASHTO) guidelines.

C = Candidate sites for marked crosswalks. Marked crosswalks must be installed carefully and selectively. Before installing new marked crosswalks, an engineering study is needed to determine whether the location is suitable for a marked crosswalk. For an engineering study, a site review may be sufficient at some locations, while a more in-depth study of pedestrian volume, vehicle speed, sight distance, vehicle mix, and other factors may be needed at other sites. It is recommended that a minimum utilization of 20 pedestrian crossings per peak hour (or 15 or more elderly and/or child pedestrians) be confirmed at a location before placing a high priority on the installation of a marked crosswalk alone.

P = Possible increase in pedestrian crash risk may occur if crosswalks are added without other pedestrian facility enhancements. These locations should be closely monitored and enhanced with other pedestrian crossing improvements, if necessary, before adding a marked crosswalk.

N = Marked crosswalks alone are insufficient, since pedestrian crash risk may be increased by providing marked crosswalks alone. Consider using other treatments, such as traffic-calming treatments, traffic signals with pedestrian signals where warranted, or other substantial crossing improvement to improve crossing safety for pedestrians.

Source: Safety Effects of Marked versus Unmarked Crosswalks at Uncontrolled Locations: Final Report and Recommended Guidelines, Table 11 FHWA, 2005

7.5.1 Pavement Markings and Static Signing

Pavement markings and static signing at midblock crosswalks should follow the guidance found in the MUTCD.

7.5.2 HAWK PHB Pedestrian Crossing Beacon

High intensity Activated crossWalk (HAWK) Pedestrian Hybrid Beacons (PHB) are used to warn and control motorists in order to assist pedestrians in crossing a street at a marked crosswalk. An example of a PHB is provided in Exhibit 7-13. Traffic signal warrants do not have to be met to install a PHB, but they may only be installed at marked crosswalks. PHBs should be considered for use at unsignalized designated crossings of multilane roadways. See Chapter 4F of the MUTCD for more information on the use and operation of PHBs.

EXHIBIT 7-13: HAWK PEDESTRIAN HYBRID BEACON



Source: Safety Effectiveness of the HAWK Pedestrian Crossing Treatment, <http://www.fhwa.dot.gov/publications/research/safety/10045/>

PHBs have been shown to reduce pedestrian crashes by 69 percent⁴. Because PHBs remain dark until activated, they can help increase driver attention to pedestrians crossing the roadway and can reduce rear-end collisions. The PHB's red signal indication removes any judgment from the motorists and requires a complete stop. The PHB provides a clear message that motorists must stop and allow pedestrians to cross the street.

PHBs are useful in locations where traditional crosswalk signings and markings do not result in adequate motorist yielding rates, and where the deployment or cost of a full traffic signal would not be warranted. This includes midblock crossings or uncontrolled mainline crossing points.

⁴ Federal Highway Administration. *Pedestrian Hybrid Beacon Guide – Recommendations and Case Study*

The MUTCD provides guidance regarding the volume of pedestrians crossing a roadway that would merit the consideration of a PHB. Graphs from the MUTCD are provided in Exhibit 7-14 and Exhibit 7-15. The MUTCD should be referred to for additional information.

EXHIBIT 7-14: GUIDELINES FOR THE INSTALLATION OF HAWK BEACONS ON LOW-SPEED ROADWAYS

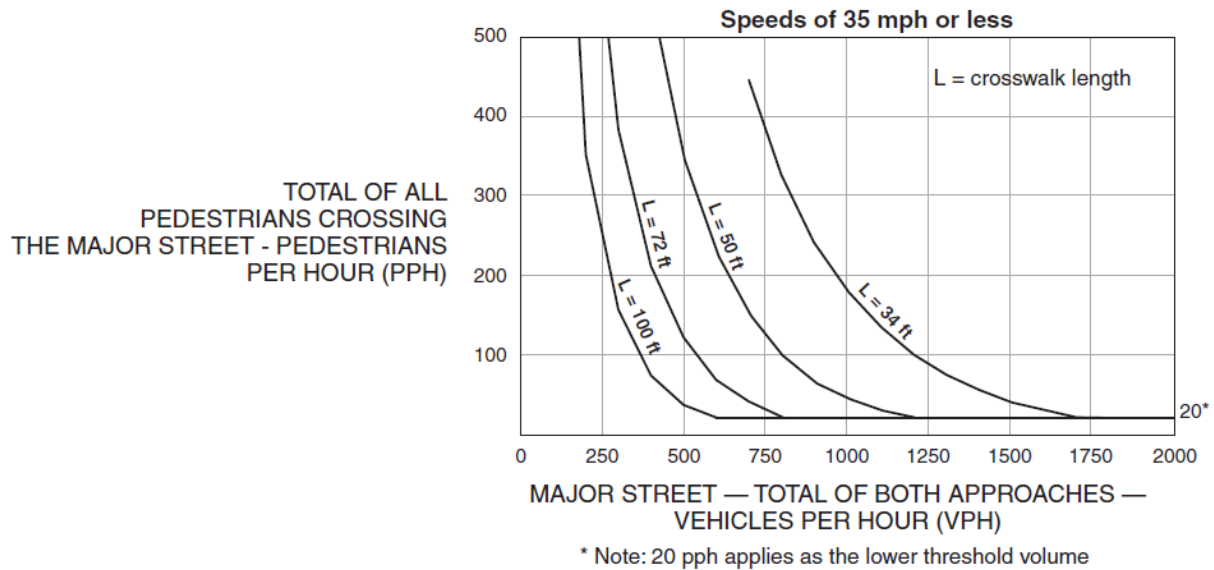

Source: MUTCD Figure 4F-1

EXHIBIT 7-15: GUIDELINES FOR THE INSTALLATION OF HAWK BEACONS ON HIGH-SPEED ROADWAYS

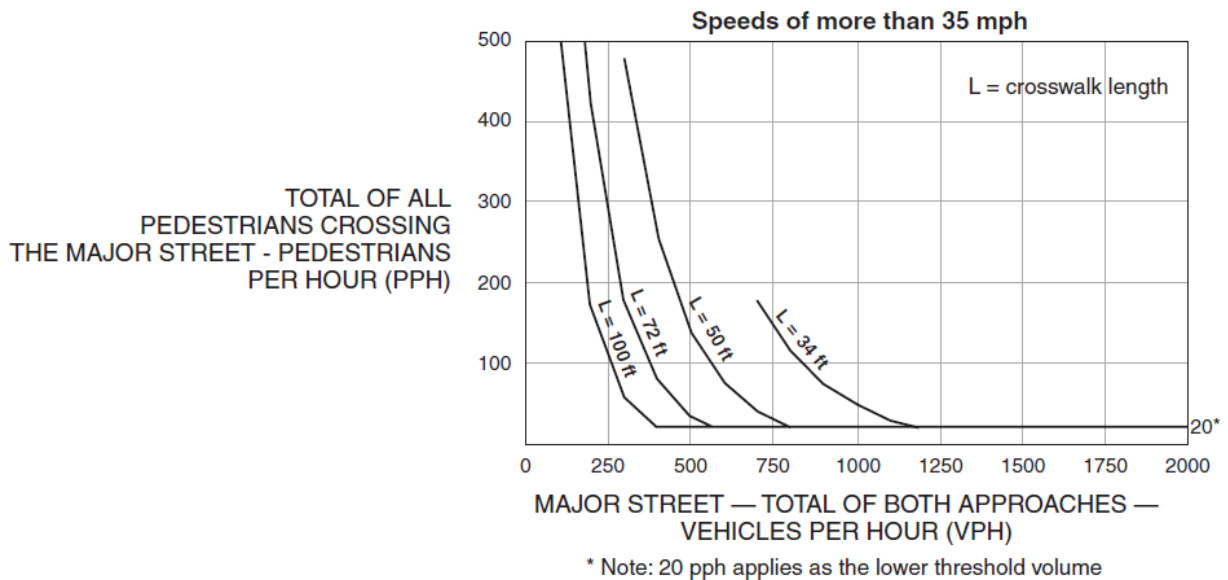

Source: MUTCD Figure 4F-2

7.5.3 Median Refuge Islands at Midblock Locations

Refer to Section 4.8 *Medians* for guidance on dimensions of median refuge islands.

Raised medians or pedestrian crossing islands at midblock locations are a proven safety countermeasure and have demonstrated a 46 percent reduction in pedestrian crashes. Pedestrian refuge areas or islands allow pedestrians to cross the street in two stages and significantly reduce the distance a pedestrian must cross at one time. The AASHTO *Pedestrian Guide* states that a crossing island should be considered “where the crossing exceeds sixty feet.” FHWA’s *Safety Effects of Marked Versus Unmarked Crosswalks at Uncontrolled Locations* reports that providing raised medians on multilane roads “can significantly reduce the pedestrian crash rate and also facilitate street crossing.”

The factors contributing to pedestrian safety associated with raised median islands include the following:

- Reduced conflicts (i.e., pedestrians address one conflict at a time);
- Reduced vehicle speeds approaching the island;
- Greater attention called to the existence of a pedestrian crossing;
- Space for additional signing and/or supplemental lighting in the middle of the road; and
- Reduced exposure time for pedestrians.

At midblock locations, it is recommended practice to angle the pedestrian crossing through a median so pedestrians can see and be more aware of traffic on the roadway they are about to cross (see Exhibit 7-16).

Median refuge islands should be considered in curbed sections of roadways in urban and suburban areas, particularly in areas where there are mixtures of significant pedestrian and vehicle traffic (more than 12,000 ADT) and intermediate or high travel speeds. On non-curbed sections of roadways, median refuge islands are applicable on roadways with design speeds \leq 45 mph. MUTCD-compliant signing and pavement marking shall be provided to make the refuge island conspicuous to motorists. Overhead street lighting should be considered when not present, also.

For roadway design speeds above 45 mph, clear zone criteria between the median and travel lane typically eliminates the applicability of median refuge islands.

EXHIBIT 7-16: ANGLED MIDBLOCK CROSSING



Source: Bruce Landis, via FHWA Safety Benefits of Raised Medians and Pedestrian Refuge Areas
Note: See Section 7.1 for guidance on detectable warning surfaces.

7.5.4 Curb Extensions/ Bulb-Outs

Where on-street parking or shoulders exist, curb extensions can be used at midblock locations to extend the sidewalk or curb line into the parking lane or shoulder, which reduces the effective street width at the midblock crossing. Curb extensions at midblock locations can:

- Reduce the crossing distance of pedestrians;
- Improve the sight distance and sight lines for both pedestrians and motorists;
- Create adequate space for curb ramps and landings where the existing sidewalk space is narrow;
- Provide additional storage space for pedestrians waiting to cross; and
- Prevent parked cars from encroaching into the midblock crosswalk area.

In general, curb extensions should extend the width of the parking lane or shoulder, with the face of curb approximately one foot from the edge line of the through travel lane. The design of a curb extension at a midblock location can encourage motorists to travel more slowly due to the visual and physical cues of the restricted street width. Curb extensions should not restrict on-road bicycle facilities by extending into or narrowing the width of a bicycle lane. Curb extensions are typically used where there is on-street parking, which would usually be along low-speed routes.

7.5.5 Raised Crosswalks

Raised crossings function as an extension of the sidewalk and allow pedestrians to cross at close to a constant grade, eliminating the need for curb ramps; however, detectable warnings are still required. Whether used in conjunction with curb extensions or used alone, raised midblock crossings effectively serve as a speed hump to slow traffic in the vicinity of the crosswalk area. They are suitable only on low-speed local streets that are not emergency routes. An example of a raised crosswalk is provided in Exhibit 7-17.

Raised crossings are typically constructed of tangent sections for the approaches and approach slopes, raising the vehicle at least three to six inches above the nominal pavement grade. Parabolic approach transitions can be more accommodating to bicyclists. The flat section of the crossing table should be 10 to 12 feet wide.

Raised crossings can affect the stability of passengers standing in transit vehicles. If used on transit routes, the raised crosswalk should be designed in consultation with the transit agency. Raised crossings should be highly visible and follow the MUTCD's signing and pavement marking guidance. Their approaches should be clearly marked or constructed of a contrasting pavement design. The pavement surface must be smooth and stable, without deep grooves or joints, to provide maximum accessibility.

EXHIBIT 7-17: RAISED CROSSWALK (WITH REFUGE ISLAND)



7.6 SHARED-USE PATHS

A shared-use path is a combined bikeway and pedestrian facility located within an independent right-of-way, or located within the street right-of-way, and physically separated from motor vehicle traffic by an open space or barrier. Because a shared-use path is not an exclusive bicycle facility, it should not normally be considered as an “equal” alternative to on-road bicycle lanes or cycle tracks.

Most shared-use paths are designated for two-way travel and are designed for both transportation and recreational purposes. Shared-use path design is similar to roadway design, but on a smaller scale and with typically lower design speeds. Shared-use paths are also to be used by pedestrians, skaters, and other non-motorized users and should be designed accordingly.

The minimum design speed for shared-use paths is 18 mph. The minimum horizontal curve radius is 60 feet. At a location where a design exceptions is granted for a curve with less than a 60-foot radius, a curve warning sign shall be placed in advance of the curve. The standard shared-use path width is 10 feet, with two-foot clear zones on either side of the path (see Exhibit 7-18). A vertical clearance of 10 feet should typically be provided. Shared-use paths must meet all applicable ADA/PROWAG requirements to the maximum extent feasible or to the extent it is not structurally impracticable. PROWAG requires that longitudinal grades not exceed five percent for pedestrian access routes outside of a street or highway right-of-way and for pedestrian access routes within street crossings. Pedestrian access routes adjacent to roadways with grades steeper than five percent may match, but shall not exceed, the general grade of the roadway.

EXHIBIT 7-18: SHARED-USE PATH TYPICAL CROSS SECTION

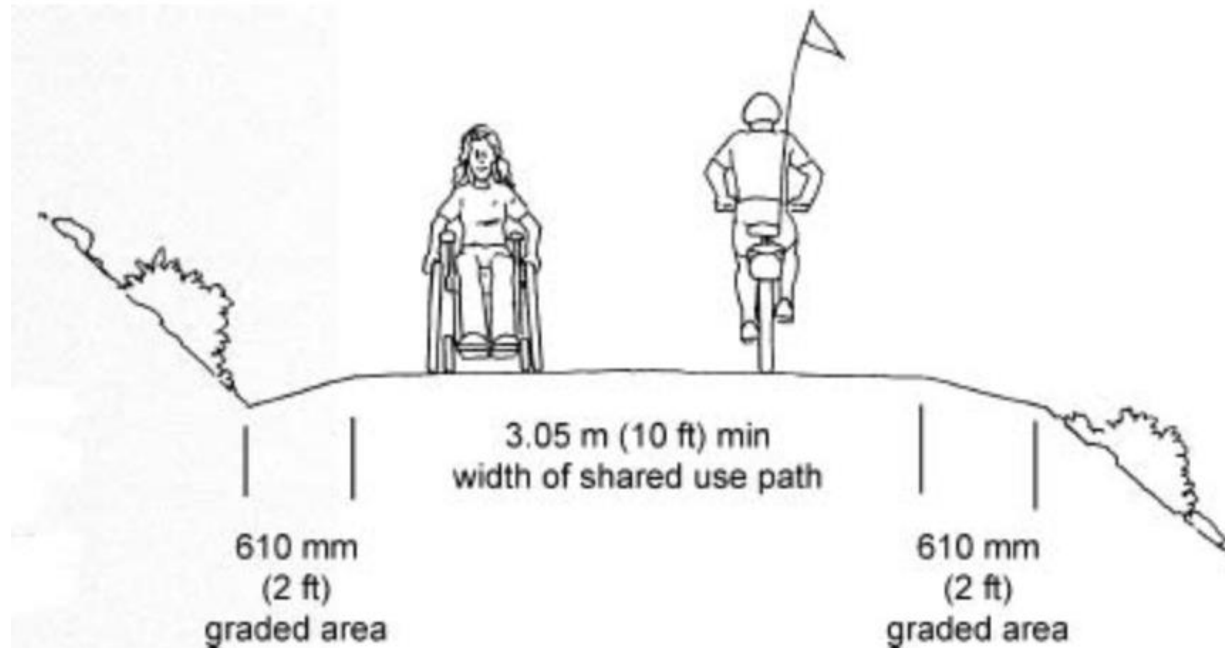

Source: FHWA Designing Sidewalks and Trails for Access

The public may confuse shared-use paths parallel to the roadway with sidewalks. Since bicycles are prohibited from use on sidewalks in many areas, pedestrian-scale signing should be considered to denote shared-use paths. Adequate signing is also needed where shared-use paths intersect roadways and other paths. Pavement markings are optional on shared-use paths; however, on TDOT projects they are required. Sections 9B and 9C of the MUTCD should be referenced for shared-use path signing and pavement marking guidance, along with TDOT Standard Drawing T-M-10: SIGNING AND PAVEMENT MARKINGS FOR SHARED-USE PATHS. Special attention should be paid to the bike route begin/end signs and intersection warning sign requirements in Standard Drawing T-M-10. Additionally, curve and steep grade warning signs are recommended where applicable on shared-use paths. An example of a shared-use path that is parallel to a roadway is provided in Exhibit 7-19.

When the shared-use path is parallel to a roadway with a design speed of 45 mph or less, a five-foot (minimum) lateral offset from the edge of roadway is required. Additional separation is preferred. The lateral offset provides a buffer to separate pedestrians and bicyclists on the path from vehicular traffic. Also, when driveways are present, the lateral offset can allow the sloped driveway apron to be placed without interfering with the shared-use path cross-slope. This helps to meet ADA requirements. For additional information, refer to Section 7.3.2 *Furnishing Zone*. When the street does not have curb, the shared use path should be placed a minimum of five feet measured from the outside edge of shoulder to the inside edge of the path.

AASHTO Roadway Design Speed Classification

Low-speed is typically ≤ 45 mph

High-speed is typically ≥ 50 mph.

When the shared-use path is parallel to a roadway with a design speed of 50 mph or more, greater lateral offset is recommended from the edge of the travel lane. Curb is typically not present on streets with design speeds of 50 mph or more. A minimum distance of 12 feet, measured from the outside edge of shoulder to the inside edge of the path, is recommended with a seven-foot absolute minimum lateral offset. If the shared-use path is located within the clear zone of the roadway, consideration should be given to a crash-worthy barrier to protect the users of the path.

The cross slope of the shared-use path should be 1.5%, and always at least one percent, but no more than two percent. The two percent maximum is a requirement of the ADA and PROWAG for pedestrian access routes. Cross slopes less than one percent can lead to ponding and mud accumulation on the shared-use path. Additionally, the graded areas adjacent to the shared-use path must allow water to drain off and away from the path.

Additional guidance from TDOT concerning the design of shared-use paths is provided in Exhibit 7-20.

EXHIBIT 7-19: SHARED-USE PATH PARALLEL TO STREET WITH PAVEMENT MARKINGS



Source: <https://www.environment.fhwa.dot.gov/stmlng/newsletters/jun14nl.asp>

EXHIBIT 7-20: TDOT SHARED-USE PATH GUIDANCE



STATE OF TENNESSEE
 DEPARTMENT OF TRANSPORTATION
 NASHVILLE, TENNESSEE 37243-0350

MEMORANDUM

TO: Whitney Sullivan
 Transportation Manager 2
 Program development and Administration Division
 Suite 600, James K. Polk Bldg.
 Nashville, TN 37243-0341

FROM: Ali R. Hangul
 CE Manager II
 Headquarters Roadway Design and Office of Aerial Surveys

DATE: October 10, 2016

SUBJECT: Non-Motorized Transportation Facility Design Criteria (Shared-Use Path)

During the development of separated non-motorized transportation facility plans, the following geometric design criteria shall be followed until the Department develops a new Multimodal Design Guideline. This criteria is applicable for all projects using federal funds.

Separated Non-motorized Facility Design Criteria

- Minimum Design Speed, 18 mph (Table 5-2, See Ref. 1)

Geometric design criteria

- Minimum bi-directional paved path width shall be based on Level of Service (LOS) in the 2010 Highway Capacity Manual (Ref.3). See the table below, which has been developed from Ref.2.

Number of users per hour	Minimum paved path width (ft.)	
	LOS B	LOS C
0-100	8	8
100-200	10	8
200-300	12	10
300-400	14	12

Minimum width of 10' for LOS C and 12' for LOS B shall be used. Design Capacity of 200-300 users per hour (LOS B) shall be used unless an analysis is completed using the Highway Capacity Manual.

- All plan title sheets shall include proposed facility design speed and capacity.
- A 2' wide clear zone with maximum 6:1 fill slope on each side of the paved surface shall be provided (Figure 5-1, Ref 1.). Sections bound by a structure, such as a pedestrian/bicycle rail, may reduce the lateral offset to 1' (See Std. Drawing RD01-TS-8).

- At fill Sections, the typical crown shall be placed on center with a maximum 1.5% cross slope. Cut and fill sections may use single slope from cut edge toward the fill section with a maximum 1.5% cross slope. Do not use superelevation rates on paths exclusive for bicycle use (see Std. Drawing RD01-TS-8).
- Maximum longitudinal slope shall be limited to 5%.
- Minimum horizontal curve radius is 60 ft. (based on 18 mph bicycle speed; See Ref.1).
- Minimum vertical clearance is 10' (8' for extreme limitations; See Ref.1).
- The geometric design of horizontal curves, vertical curves, stopping sight distance, and horizontal sight distance shall follow the guidelines in Chapter 5 of Ref.1.

Structures

- The proposed structure width shall follow the above paved path guideline with an additional 1' lateral clearance on both sides and proper safety rail (See Std. Drawing RD01-TS-8).

Drainage

- Gravity walls or retaining wall sections shall consider additional drainage (See Std. Drawing RP-S-9).
- No offsite runoff over the facility is allowed.

Signing and marking

- All signs shall adhere to the minimum sizes specified in the MUTCD, Section 9B.02 (Ref. 4).
- Warning signs shall be placed a minimum of 100' in advance of locations where the curve radius is smaller than the required 60 ft. (See Ref. 1). They shall also be placed 2' offset from paved surfaces. (See Std. Drawing RD01-TS-8 and Figure 5-1, Ref. 1).
- All path intersections with roadways shall have proper pavement marking and signage for both facilities. (See Std. Drawing T-M-10).

Safety features

- If the edge drop-off warrants a safety rail, use 42" pedestrian/bicycle rail height per Std. Drawing S-BPR-1 (See also Figure 5-3 Ref. 1).
- A proper separation, exceeding the minimum clear zone (See Std. Drawing S-CZ-1), shall be provided for facilities adjacent to an existing roadway. If the proposed non-motorized facility cannot be placed outside the clear zone, then a barrier protection is required (See Std. Drawing RD01-TS-8) to protect vulnerable users from motorists. Based on the posted design speed of the existing roadway, a variety of barrier shapes and types are available. Seek advice from the Roadway Design Standards and Policies section if more information is needed.
- Appropriate curb ramps should be placed throughout the facility and should be based on TDOT RP-H series standards.
- Truncated domes should be yellow, cover the full width of the ramp, and extend only 2' from the edge (See Std. Drawing RP-H-3).

Currently, the Department has no formal design exception request process for the locations where the above criteria cannot be met. Therefore, please consult with the Roadway Design QA/QC section for advice at any time during the development of the plans. All mitigation practices shall be included as a special note on the plan sheets.

References:

1. AASTHO Guide for the Development of Bicycle Facilities, 2012 Fourth Edition
2. Shared-Use Path Level of Service Calculator - A User's Guide, FHWA Report No. FHWA-HRT-05-138
3. 2010 Highway Capacity Manual
4. MUTCD, 2009 Edition

7.7 SECTION 7.0 SOURCES

1. American Association of State Highway and Transportation Officials. (2011). *A Policy on Geometric Design of Highways and Streets*. Washington, D.C.
2. City of Los Angeles, CA. (2015). *City of Los Angeles Complete Streets (Draft)*. Los Angeles, CA.
3. Federal Highway Administration. *Designing Sidewalks and Trails for Access, Part II of II: Best Practices Design Guide*. Retrieved December 30, 2016 from, https://www.fhwa.dot.gov/environment/bicycle_pedestrian/publications/sidewalk2/sidewalks214.cfm
4. Federal Highway Administration. (2012). *Manual on Uniform Traffic Control Devices*. Washington, D.C.
5. Federal Highway Administration. *Medians and Pedestrian Crossing Islands in Urban and Suburban Areas*. Retrieved March 27, 2017 from, https://safety.fhwa.dot.gov/provencountermeasures/fhwa_sa_12_011.cfm
6. Federal Highway Administration. *Pedestrian Hybrid Beacon Guide – Recommendations and Case Study*. Retrieved November 7, 2016 from, http://safety.fhwa.dot.gov/ped_bike/tools_solve/fhwasa14014/
7. Federal Highway Administration. *Safety Benefits of Raised Medians and Pedestrian Refuge Areas*. Retrieved November 18, 2016 from, http://safety.fhwa.dot.gov/ped_bike/tools_solve/medians_brochure/
8. Federal Highway Administration. *Safety Effectiveness of the HAWK Pedestrian Crossing Treatment*. Retrieved November 7, 2016 from, <http://www.fhwa.dot.gov/publications/research/safety/10045/>
9. Federal Highway Administration. (2005). *Safety Effects of Marked versus Unmarked Crosswalks at Uncontrolled Locations: Final Report and Recommended Guidelines*. Washington, D.C.
10. Florida Department of Transportation. (2015). *Plans Preparation Manual Chapter 8, Pedestrian, Bicycle and Public Transit Facilities*. Tallahassee, FL.
11. Georgia Department of Transportation. (2014). *Design Policy Manual*. Atlanta, GA.
12. Hangul, Ali (2016, October 10). *Non-Motorized Transportation Facility Design Criteria (Shared-Use Path)*. TDOT Design Division, Nashville, TN.
13. Institute of Transportation Engineers. (2010). *Designing Walkable Urban Thoroughfares: A Context Sensitive Approach*. Washington, D.C.
14. National Cooperative Highway Research Program. (2016 Draft). *Proposed Update of the AASHTO Guide for the Planning, Design, and Operation of Pedestrian Facilities*. Report 15-45 (Draft). The National Academies of Sciences, Engineering, and Medicine, Washington, D.C. http://mutcd.fhwa.dot.gov/resources/interim_approval/ia11/ia11_rfb_iapmemo.pdf
15. National Cooperative Highway Research Program. (2011). *Crossing Solutions at Roundabouts and Channelized Turn Lanes for Pedestrians with Vision Disabilities*. Report 674. The National Academies of Sciences, Engineering, and Medicine, Washington, D.C.

8.0 TRANSIT ACCOMMODATIONS

Bus stops connect modes of transportation. For transit to be well utilized, pedestrians, bicyclists, and transferring passengers need access to bus stops. Bus stops are often located in areas with high pedestrian volumes, such as near transportation centers and business districts, but they also serve suburban and rural areas.

In low-speed urban areas, clear zone is not applicable. Minimum offsets typically control the distance structures need to be placed from the curb (as low as four feet per TDOT Standard Drawing S-CZ-1 CLEAR ZONE CRITERIA). Outside urban, low-speed environments, designers often need to consider roadway clear zone requirements and roadside drainage features that may present challenges to bus stop locations and access. To improve safety, “forgiving” roadway designs are often utilized that include relatively large clear zones. However, this approach may prevent the inclusion of desirable bus stop elements such as bus shelters. The 2011 AASHTO Green Book identifies flexibility in the clear zone requirements, where engineering judgment and local context should be used to select an appropriate clear zone distance for the specific road and bus stop location.

8.1 TRANSIT STOPS

Waiting for, boarding, and alighting from transit typically takes place in the sidewalk corridor. Ideally, this would take place in the furnishing zone so travel along the throughway zone is not impacted. Transit stops should be located where boarding and alighting areas are accessible. Specific requirements for transit stops are provided in the United States Access Board’s *Proposed Accessibility Guidelines for Pedestrian Facilities in the Public Right-of-Way* (PROWAG), Section R308 *Transit Stops and Transit Shelters*. PROWAG has been adopted by TDOT.

8.1.1 Curbside

A route accessible by people with disabilities must link the boarding and alighting area to the throughway zone of the sidewalk, and to bus shelters (if present). The presence of a shelter should be accounted for when determining the appropriate width of the furnishing zone, and it should not interfere with the flow of travel within the throughway zone. Refer to Section 7.3 for additional information on sidewalk design and zones.

Within the boarding areas, accessibility requirements mandate that slopes be like those of the throughway zone of the sidewalk: the grade parallel to the road must equal the roadway slope to the extent practicable, while the cross slope (perpendicular to the road) shall be a maximum of two percent.

Each boarding and alighting area must provide a clear area five feet wide (parallel to the roadway) by eight feet long (perpendicular to the roadway) to accommodate the extension of assistive lifts from accessible buses and allow for wheelchairs to maneuver onto and off of the lift (see Exhibit 8-1). This space should be clear of all obstructions. In constrained corridors with infrequent bus service and low sidewalk volumes, it may overlap other clear spaces, such as the pedestrian access route. Additional dimensions related to transit stops are provided in Exhibit 8-2.

EXHIBIT 8-1: PROWAG TRANSIT BOARDING AND ALIGHTING AREA REQUIREMENTS

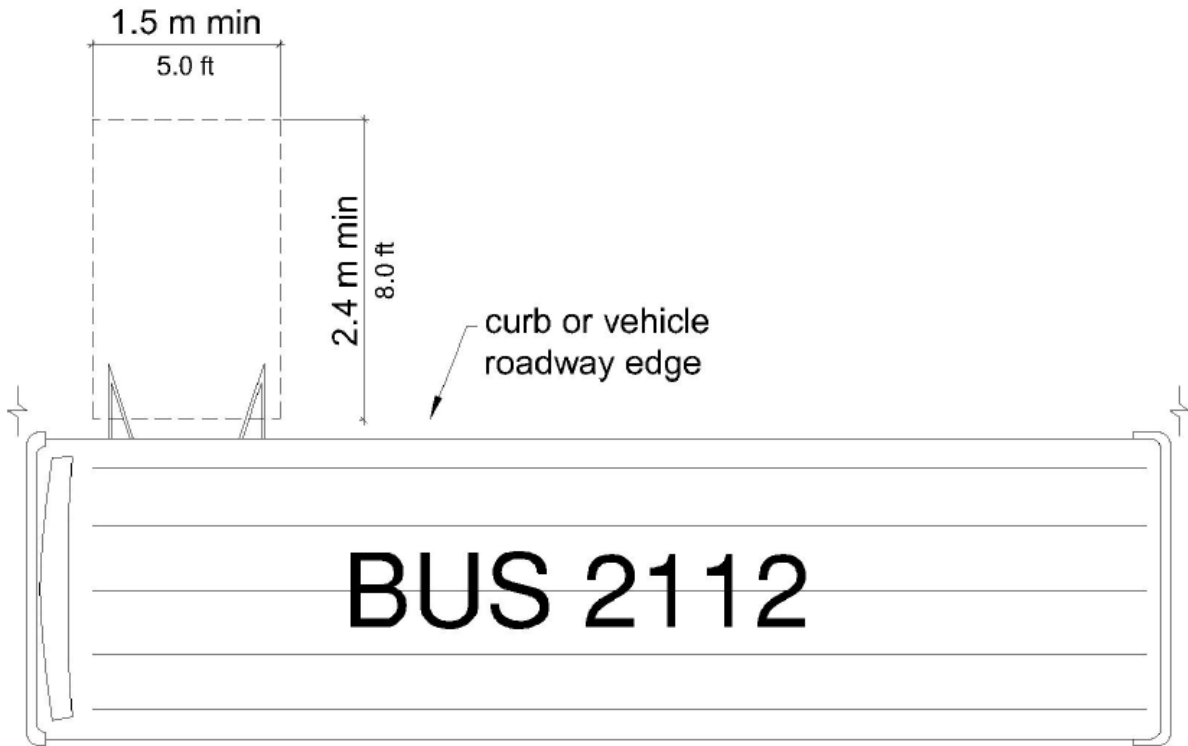

Source: PROWAG

EXHIBIT 8-2: MINIMUM DIMENSIONS FOR CURBSIDE TRANSIT FACILITIES

Transit Facility or Design Element	Minimum Dimension
Lane width to accommodate standard urban bus, LRT vehicle, or streetcar	11 feet
Curbside bus stop length and no-parking zone (add 20 feet for articulated vehicles)	
Near-side bus stop	100 feet
Far-side bus stop	80 feet (Plus 5 feet from crosswalk or curb return)
Far-side bus stop after turn	90 feet (Plus 5 feet from crosswalk or curb return)
Midblock	120 feet
Bus bulb stop length (near side or far side)	40 feet
Distance between front of vehicle at near-side stop and crosswalk	10 feet
Single-side LRT/BRT platform width conforming to ADA guidelines	10 feet (8 feet plus 2 feet tactile strip)
Distance between LRT double track centerlines	12 feet
Maximum grade for LRT operation	6%
Height of platform	Low: 10 inches High: 36 inches
Width of two-track LRT channel	22 feet
Vertical clearance for LRT (top of rail to bottom of wire)	11.5 feet
Width of right of reserve for two tracks	19–33 feet
LRT/BRT station widths (including running way)	
Dual outside platforms	41 feet
Single center platform	55 feet
Single outside platform	31 feet

Source: ITE Designing Walkable Urban Thoroughfares, a Context Sensitive Approach, pg. 162

8.1.2 Curb Extensions/ Bus Bulbs

Bus bulbs are curb extensions utilized primarily for a bus stop. Curb extensions are typically applicable along streets with on-street parking. Curb extensions are typically six feet in width. Their length should allow passengers to use the front and back doors of a bus. For reference, a standard bus is 40 feet long and an articulated bus is 60 feet long.

Besides reducing the pedestrian crossing distances, curb extensions can reduce the impact to parking compared to typical bus zones, mitigate traffic conflicts with autos for buses merging back into the traffic stream, make crossing pedestrians more visible to drivers, and create additional space for passenger queuing and amenities on the sidewalk, such as a shelter and/ or a bench.

Sections 7.4.1 and 7.5.4 should be referenced for additional information concerning curb extensions at intersection and midblock locations, respectively.

8.1.3 Bus Turnouts

A bus turnout is a recessed curb area located adjacent to the traffic lane (see Exhibit 8-3). Bus turnouts are desirable only under certain conditions because of the delay created when the bus must reenter traffic. They should typically not be located on the near side of signalized intersections due to the difficulty for buses to reenter the traffic stream (queued vehicles block the turnout on the red cycle and moving traffic prevents reentry on the green cycle).

EXHIBIT 8-3: BUS TURNOUT



Source: Southeastern Pennsylvania Transportation Authority

Bus turnouts have the following advantages:

- Allow traffic to proceed around the bus, reducing delay for other traffic
- Maximize vehicular capacity of high-volume vehicle mobility priority streets
- Clearly define the bus stop
- Passenger loading and unloading can be conducted in a more relaxed manner
- Reduce potential for rear-end crashes

Bus turnouts have the following disadvantages:

- Make it more difficult for buses to reenter traffic, increasing bus delay and average travel time for buses
- Difficulty of buses pulling parallel to curb, reducing accessibility
- Greater crash risk for buses pulling back into traffic than buses stopped in traffic lane
- Use additional space and might require right-of-way acquisition

Typical bus turnouts consist of a 40 to 60-foot long entrance taper, a stopping area that is 40 to 60 feet long (for a standard and articulated bus, respectively), and a 40 to 60-foot long exit taper.

8.2 TRANSIT STOP PLACEMENT

8.2.1 At Intersections

The preferred location for bus stops is the near or far side of an intersection. Intersection stops provide the best pedestrian accessibility from both sides of the street and the cross streets. Guidance from ITE's *Designing Walkable Urban Thoroughfares: A Context Sensitive Approach* concerning preferred stop location based on various roadway characteristics is provided below and in Exhibit 8-4.

- Consider a near-side stop on two-lane streets where vehicles cannot pass a stopped bus
- Consider a far-side stop on streets with multiple lanes where vehicular traffic may pass uncontrolled around the bus
- On streets where vehicular traffic is controlled by a signal, the bus stop may be located either on the near side or on the far side, but the far side is preferable
- Where it is not desirable to stop the bus in a lane and a bus turnout is warranted, a far side or midblock stop is generally preferred
- When locating a bus stop in the vicinity of a driveway, consider issues related to sight distance, blocking access to development, and potential conflicts between automobiles and buses

EXHIBIT 8-4: ADVANTAGES AND DISADVANTAGES OF FAR AND NEAR SIDE BUS STOPS

Far Side Bus Stops	
Advantages	Disadvantages
<ul style="list-style-type: none"> • Minimizes conflict between buses and right turning vehicles traveling in the same direction • Minimizes sight distance problems on approaches to the intersection • Encourages pedestrians to cross behind the bus • Minimizes area needed for curbside bus zone • If placed just beyond a signalized intersection in a bus turnout, buses may more easily re-enter the traffic stream • If a turnout is provided, vehicle capacity through intersection is unaffected • Can better take advantage of traffic signal priority for buses 	<ul style="list-style-type: none"> • If bus stops in travel lane, could result in traffic queued into intersection behind the bus (turnout will allow traffic to pass around the stopped bus) • If bus stops in travel lane, could result in rear-end accidents as motorists fail to anticipate stopped traffic • May cause passengers to access buses further from crosswalk • May interfere with right turn movement from cross street • May obscure sight distance for crossing vehicles • If signal priority not in use, bus may have to stop twice, once at signal and then at bus stop
Near Side Bus Stops	
Advantages	Disadvantages
<ul style="list-style-type: none"> • Minimizes interference when traffic is heavy on the far side of an intersection • Allows passengers to access buses close to crosswalk • Driver may use the width of the intersection to pull away from the curb • Allows passengers to board and alight when the bus is stopped for a red light • Provides the driver with the opportunity to look for oncoming traffic, including other buses with potential passengers 	<ul style="list-style-type: none"> • Stopped bus interferes with right turns • May cause sight distance problem for approaching traffic, cross-street traffic and pedestrians • If located in a pullout or shoulder or at a signalized intersection, a traffic queue may make it difficult for buses to re-enter the traffic stream • Prohibits through traffic movement with green light, similar to far side stop without a bus turnout • May cause pedestrians to cross in front of the bus at intersections • Limits use of traffic signal priorities

Source: *Bus Stop Safety and Design Guidelines Manual*, Orange County Transportation Authority and Kimley-Horn and Associates, Inc. via ITE *Designing Walkable Urban Thoroughfares: A Context Sensitive Approach* Table 10.4.

8.2.2 At Midblock Locations

Bus stops may be placed at midblock locations on long blocks or to serve a major transit generator. At midblock bus stops, crosswalks should be considered. If a midblock crosswalk is provided, it should be placed behind the bus stop so passengers do not cross in front of the bus, where they are hidden from passing traffic. Advantages and disadvantages of midblock bus stops are provided in Exhibit 8-5. The guidance provided in Section 7.5 should be followed concerning midblock crosswalk placement and design.

EXHIBIT 8-5: ADVANTAGES AND DISADVANTAGES OF MIDBLOCK BUS STOPS

Advantages	Disadvantages
Minimizes sight distance problems for motorists and pedestrians	Requires additional distance for no-parking restrictions
Might result in passenger waiting areas experiencing less pedestrian congestion	Increases walking distance for patrons crossing at an intersection or requires special features to assist pedestrians with midblock crossing
Might be closer to passenger origins or destinations on long blocks	Encourages uncontrolled midblock pedestrian crossings
Might result in less interference with traffic flow	Only serves adjacent generators and does not afford system transfers to other lines often found at intersections

Source: ITE Designing Walkable Urban Thoroughfares: A Context Sensitive Approach Table 9.9.

8.3 SECTION 8.0 SOURCES

1. Federal Highway Administration. (2016). *Achieving Multimodal Networks, Applying Design Flexibility & Reducing Conflicts*. Washington, D.C.
2. Institute of Transportation Engineers. (2010). *Designing Walkable Urban Thoroughfares: A Context Sensitive Approach*. Washington, D.C.
3. United States Access Board. (2011). *Proposed Accessibility Guidelines for Pedestrian Facilities in the Public Right-of-Way*. Washington, D.C.

[This page intentionally left blank]

9.0 SIGNAL TIMING CONSIDERATIONS

The MUTCD, ITE's *Traffic Engineering Handbook*, and TDOT's *Traffic Design Manual* provide guidance for the warrants, design, and operation of traffic signals. Traffic signal design is complex, and beyond the scope of this manual. However, supplemental recommendations for the traffic signal designer and operator to consider in multimodal environments are provided below.

In Tennessee, TDOT typically funds the construction of traffic signals on State Routes. Pedestrian pushbuttons, marked crosswalks, and pedestrian signals should be provided at all locations with existing or planned sidewalks, and within all suburban or urban land use contexts. Pedestrian pushbuttons and signals shall be used where there are existing or proposed marked crosswalks. If marked crosswalks are not present, and will not be added, pedestrian signals are not required.

Pedestrian pushbuttons, crosswalks, and pedestrian signals should be provided at all locations with existing or planned sidewalks, and/or within all suburban or urban land use contexts. On TDOT projects, accessible pedestrian signals (APS) and pushbuttons with audible guidance shall be used at crosswalks in order to comply with ADA and PROWAG.

On state or federally funded projects where pedestrian signals are newly installed, replaced, or significantly modified, the installation of accessible pedestrian signals (APS) and countdown pedestrian displays is required. APS includes audible and vibrotactile indications of the WALK interval. Installation of these devices may require improvements to existing sidewalks and curb ramps to ensure Americans with Disabilities Act (ADA) and the United States Access Board's *Proposed Accessibility Guidelines for Pedestrian Facilities in the Public Right-of-Way* (PROWAG) compliance.

The operation and maintenance of the signals are typically the responsibility of the local agency. This includes maintaining appropriate signal timing strategies. Signal cycle lengths of up to 120 seconds are typically acceptable to optimize vehicular traffic movements. The typical maximum cycle length is 150 seconds. However, short cycle lengths of 60–90 seconds are more appropriate for urban areas with high pedestrian and/or bicyclist activity. Expecting pedestrians or bicyclists to wait 120 seconds or more before receiving a walk signal is not preferred. When developing a signal cycle plan, the designer should weigh the effects on all users, vehicular, pedestrian, and cyclist.

Many municipalities in Tennessee place their signals under flash operations late at night and into the early morning. This practice should not be done, especially on multilane routes, if pedestrian activity is expected late at night. Such areas could include where late night events occur. Traffic controllers cannot accept a pedestrian push button call when in flash operations.

When a project's limits begin or end an intersection, all approaches to the intersection must be upgraded with similar multimodal features such that pedestrians and cyclists can more safely traverse the intersection. If curb ramps are installed, they must be installed in all quadrants of an intersection with curb. If the vehicular lanes are modified, the signal heads will typically need to be replaced or shifted, along with possible modifications to the signal cabinet.

Exhibit 9-1 summarizes signal timing strategies based on the adjacent land use context. The exhibit provides guidance when different multimodal users should be weighted more heavily when developing a signal timing plan.

EXHIBIT 9-1: SIGNAL TIMING STRATEGIES, SETTINGS, AND POLICY EXAMPLES

Transportation Policy	Land Use Context	Signal Timing Strategy
Pedestrian/Bicycle-Focused	Downtowns, Schools, Universities, Dense Multi-Use Development, Parks, or any location with high pedestrian/bicycle traffic.	<ul style="list-style-type: none"> • Shorter cycle lengths to reduce wait times • Extended Pedestrian crossing timing • Bicycle/Pedestrian Detection • Exclusive Pedestrian Phasing • Leading Pedestrian Interval
Transit-Focused	Transit-corridors, along transit routes, near transit stations or crossings.	<ul style="list-style-type: none"> • Signal preemption for high importance transit modes (i.e. rail) • Signal priority for strategic transit modes and routes • Signal coordination based on transit vehicle speeds • Extended Pedestrian crossing timing • Exclusive Pedestrian Phasing • Leading Pedestrian Interval
Automobile-Focused / Freight-Focused	Locations with high automobile or truck/freight traffic, facilities of regional importance, freight corridors, ports, or intermodal sites.	<ul style="list-style-type: none"> • Avoid cycle failure (i.e. queued vehicles not making it through the intersection on a single green indication) • Maintain progression on coordinated systems as best as possible to avoid unnecessary stops and delay • Use appropriate cycle lengths (Shorter cycle lengths will typically result in less delay, but increased “lost time” (time lost in vehicle deceleration, driver reaction time, and vehicle acceleration), while longer cycle lengths may result in more delay, less “lost time”, and potentially more vehicle throughput depending on traffic demand) • Ensure appropriate pedestrian signal timing to allow safer multimodal use of the roadway network.

Source: FHWA Traffic Signal Timing Manual

9.1 SECTION 9.0 SOURCES

1. Federal Highway Administration. (2008). *Traffic Signal Timing Manual*. FHWA-HOP-08024. Washington, D.C.
2. Institute of Transportation Engineers. (2010). *Designing Walkable Urban Thoroughfares: A Context Sensitive Approach*. Washington, D.C.
3. Institute of Transportation Engineers. (2016). *Traffic Engineering Handbook, Seventh Edition*. Hoboken, NJ.
4. National Association of City Transportation Officials. (2012). *Urban Street Design Guide*. New York, NY.

[This page intentionally left blank]

10.0 MULTIMODAL ACCOMMODATIONS IN RESURFACING PROJECTS

TDOT's Roadway Design Guidelines (Section 1-200.12) specify certain pedestrian and bicyclist accommodations to be incorporated into resurfacing projects. Curb ramps shall be installed/retrofitted where they are missing or are not compliant with ADA/PROWAG guidance, to the maximum extent feasible. When a project's limits begin or end at an intersection, all approaches to the intersection must be upgraded with similar multimodal features such that pedestrians and cyclists of all abilities can traverse the intersection. Where curb ramps are installed, they must be installed in all four quadrants of an intersection. Pedestrian pushbuttons and signals shall be used where there are existing or proposed marked crosswalks at signalized intersections. On new signal installations, or where an existing signal is modified, the pedestrian pushbuttons and signals shall have audible guidance to meet the accessibility requirements in the PROWAG. If marked crosswalks are not present, and will not be added, accessible pedestrian signals (APS) are not required. The installation of APS are also not required at existing crosswalk locations if the existing pedestrian signals and pushbuttons are in working order and do not need to be modified for other reasons.

Additionally, TDOT promotes that when the existing shoulders are adequate (see Section 6.2 Bicycle Lanes), resurfacing projects provide a good opportunity to incorporate pavement markings for bicycle lanes. Also, where the existing catch basin grates adjacent to the curb are parallel-type grates, TDOT will install bicycle-friendly perpendicular-type catch basin grates.

10.1 SECTION 10.0 SOURCES

1. Federal Highway Administration. (2016). *Flexibility in Highway Design*. Washington, D.C., <http://www.fhwa.dot.gov/environment/publications/flexibility/ch02.cfm>
2. Federal Highway Administration. (2016). *Incorporating On-Road Bicycle Networks into Resurfacing Projects*. Washington, D.C.
3. Tennessee Department of Transportation. (2016) *Design Guidelines, Chapter 1*. Nashville, TN
4. Tennessee Department of Transportation. (2016) *TDOT Pedestrian Accessibility and Bicycle Accommodation Checklist*. Nashville, TN

[This page intentionally left blank]

11.0 IMPLEMENTING MULTIMODAL ELEMENTS AT INTERCHANGES

One of the more challenging areas to design multimodal facilities is in interchange areas. Interchanges often provide the only pedestrian and bicycle access across a freeway, but are not always designed to provide comfortable pedestrian and bicycle access. The best interchange configurations for pedestrians and bicyclists are those where the ramp intersects the crossroad at a 90-degree angle and where a stop sign or signal controls the intersection. These characteristics cause motorists to slow down before turning, increasing the likelihood that they will see and yield to non-motorists. If an impact occurs, severity is lessened because of slower vehicular speeds.

At interchanges, sidewalks and bicycle lanes should be provided where appropriate (see Sections 7.0 and 6.0, respectively). When feasible, the intersection of freeway ramps and local streets should be designed like other multimodal-friendly intersections in terms of slow vehicle approach speeds, narrow crossing distances, and appropriate signs, signals, and markings. Traffic and pedestrian signals are often appropriate at the intersection of ramps with the surface streets, and these can be timed to facilitate safer pedestrian travel (see Section 9.0). When free-flow right-turn lanes are necessary, they should be designed to be as pedestrian and bicyclist friendly as possible in terms of roadway approach angle (see Section 4.2), marked crosswalks (see Section 7.4), and narrow turn lanes (see Section 4.4). Raised medians or islands that can serve as refuge areas are recommended to allow crossing the roadway in phases (see Section 4.8). Street lighting may help create a safer pedestrian environment near interchange areas.

Ideally, free-flow turn lanes would not be constructed where pedestrian and bicyclist activity exists. However, if a traffic analysis demonstrates that free-flow lanes are required to prevent vehicular queues from reaching the mainline of the highway they should be considered. The planning and conceptual design for interchange improvements at State Routes and Interstates must be coordinated with TDOT's Strategic Transportation Investments Division. The project team's design recommendations should balance the safety of motorists with that of pedestrians and bicyclists. For new construction projects, the design team should consider an interchange configuration that is more accommodating to pedestrians and bicyclists. These types include diamond interchanges and partial cloverleaf interchanges that do not have free-flow turn lanes on the arterial. Examples are shown in Exhibit 11-1. If a diverging diamond interchange configuration is selected, current guidance recommends placing pedestrians and bicyclists in the median between the ramps. Examples of interchange configurations that are more difficult to accommodate pedestrians and bicyclists include trumpet interchanges, partial and full cloverleaf interchanges with free-flow turn lanes, and single point interchanges. Examples are shown in Exhibit 11-2.

Chapter 9 of Caltrans' *Complete Intersections: A Guide to Reconstructing Intersections and Interchanges for Bicyclists and Pedestrians* is an excellent resource for treatments to improve pedestrian and bicycle access at interchanges. It can be downloaded at:

http://nacto.org/docs/usdg/complete_intersections_caltrans.pdf

EXHIBIT 11-1: PEDESTRIAN AND BICYCLIST ACCESSIBLE INTERCHANGE CONFIGURATIONS

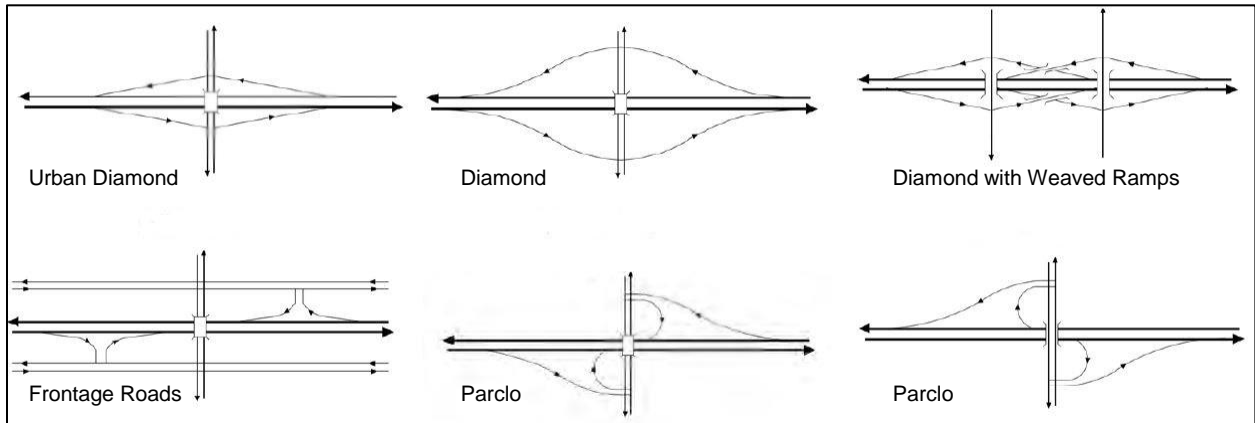

Source: Adapted from Caltrans

EXHIBIT 11-2: PEDESTRIAN AND BICYCLIST CHALLENGING INTERCHANGE CONFIGURATIONS

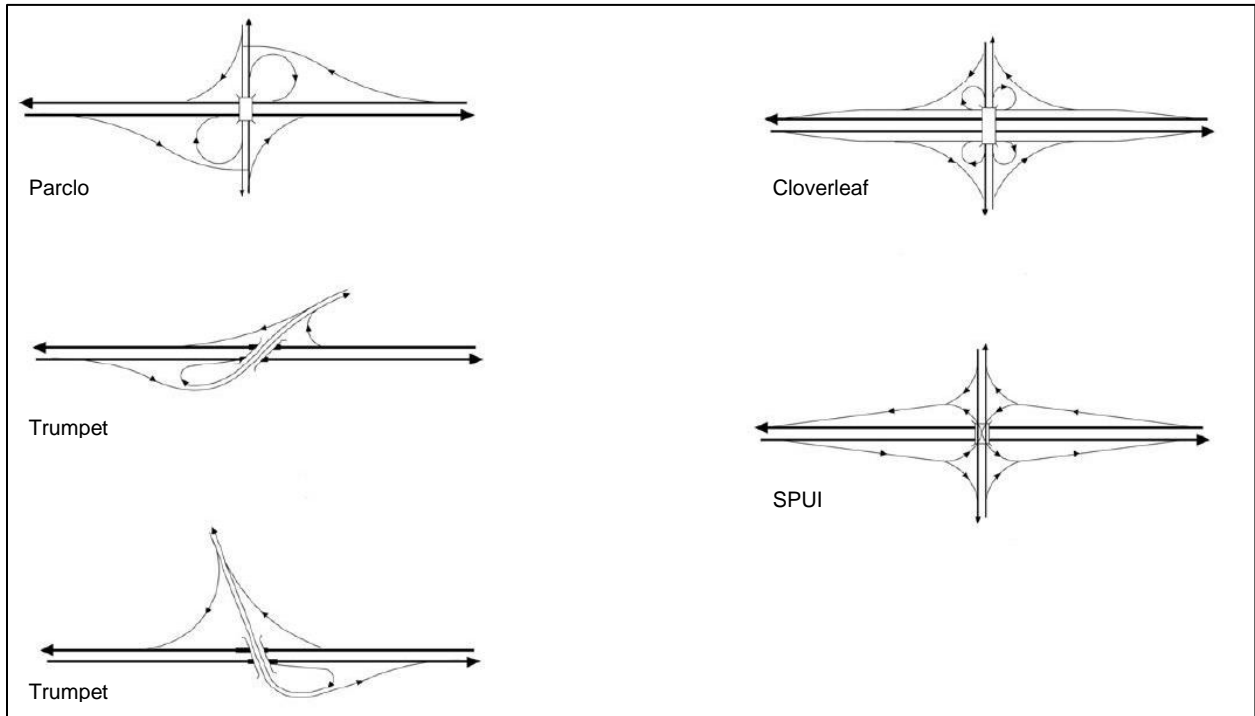

Source: Adapted from Caltrans

11.1 SECTION 11.0 SOURCES

1. California Department of Transportation. (2010). *Complete Intersections: A Guide to Reconstructing Intersections and Interchanges for Bicyclists and Pedestrians*. Sacramento, CA
2. Federal Highway Administration. *Pedestrian Safety Guide and Countermeasure Selection System; Bicycle Safety Guide and Countermeasure Selection System*. Washington, D.C., Retrieved January 10, 2017 from: <http://www.pedbikesafe.org/>

[This page intentionally left blank]

12.0 OTHER UTILIZATIONS OF PUBLIC RIGHT-OF-WAY

Streets, especially in urbanized areas, should be public spaces as well as channels for movement. Well-designed streets can generate higher revenues for businesses and higher values for homeowners. In urbanized areas where sidewalks are present, street furniture is a common feature. Street furniture such as seating, trash receptacles, and drinking fountains provides both a functional service to pedestrians and a visual detail and interest. Other common non-travel related uses of the public right-of-way include locations for utilities, space for landscaping, and stormwater accommodations. These other uses of the public right-of-way are necessary or desirable, but shall not interfere with the safety and mobility of pedestrians or bicyclists, and their placement shall not conflict with ADA requirements to the maximum extent feasible or to the extent it is not structurally impracticable.

12.1 UTILITIES

When sidewalks are planned or present, the effective management of utility placement on, above, and below the sidewalk area ensures a safer and more aesthetic street environment. Utilities that affect sidewalk functionality include surface-mounted facilities such as utility vault and signal boxes; aboveground infrastructure such as power and telecommunications wiring; and underground infrastructure serving electricity, storm drainage, sewer and water, gas, telecommunications, street lighting, and traffic signalization.

Well-placed utilities and other infrastructure reduce clutter on the sidewalk, improve pedestrian safety, reduce maintenance conflicts with other street amenities, and allow for more landscaping and trees. Considerations for utility placement include:

- Aboveground utilities should be paced at least 18 inches from the back of curb and may not interfere with the minimum pedestrian throughway. If buildings do not abut the right-of-way, place utilities behind the sidewalk, where they will not interfere with the use of the adjacent property.
- Longitudinal underground utility lines should be located in a uniform alignment as close to the right-of-way as practical, or within the furnishing zone. In urban areas with abutting buildings, locate utilities within the parking lane or furnishing zone.

Section 7.3 *Sidewalk Design with Curb* provides information and dimensions concerning the various zones of a sidewalk and their purpose. When sidewalks and curb and gutter are not present, the location of aboveground utilities should be placed an adequate distance from the travel lanes such that the roadside environment is free of fixed objects. Clear zone requirements from the *AASHTO Roadside Design Guide* should be followed.

12.2 LANDSCAPING AND GREEN INFRASTRUCTURE

Vegetation, especially trees, help to visually break-up the concrete and asphalt surfaces of the roadway and improve a roadside's aesthetics. Trees provide shade from the sun, intercept stormwater, and buffer pedestrians from passing vehicle traffic. Ground cover, grasses, and shrubs are appropriate supplements to add character along residential streets. For improved safety, landscape and hardscape enhancements should not obstruct the view between pedestrians (including those in wheelchairs) and motorists. Elements over 24 inches tall must be placed and spaced so they do not create unsafe conditions for these most vulnerable users.

If a continuous canopy of trees is desired, space street trees between 15 and 30 feet on center, depending upon species. In more urban zones and along street segments with predominantly commercial ground floor uses, trees should be planted in tree wells covered by tree grates to maximize surface area for pedestrian circulation. The width of the streetside landscaped strip should be at least five feet (preferred width is eight feet) to support healthy tree growth.

Green infrastructure, including bioswales, is landscaping designed with the intent of mitigating stormwater pollution. Bioswales are vegetated, mulched, or xeriscaped channels that provide treatment and retention as they move stormwater from the street. Vegetated swales slow, infiltrate, and filter stormwater flows. As linear features, they are particularly well suited to being placed along streets and parking lots. Bioswales are typically planted with hearty native plant species that require little to no maintenance. The width of a bioswale channel varies depending upon the amount of stormwater to be treated.

EXHIBIT 12-1: 28TH/31ST AVENUE CONNECTOR IN NASHVILLE WITH LANDSCAPING AND BIOSWALES



12.3 SECTION 12.0 SOURCES

1. *City of Los Angeles Complete Streets (Draft)*. (2015). Los Angeles, CA. City of Los Angeles, CA.
2. Institute of Transportation Engineers. (2010). *Designing Walkable Urban Thoroughfares: A Context Sensitive Approach*. Washington, D.C.
3. National Association of City Transportation Officials. (2012). *Urban Street Design Guide*. New York, NY.
4. United States Environmental Protection Agency. *Green Infrastructure*. Retrieved December 29, 2016 from: <https://www.epa.gov/green-infrastructure/what-green-infrastructure#bioswales>

13.0 MULTIMODAL-SCALE BARRIERS

TDOT is currently developing barrier standards to serve bicycle, pedestrian, and motor vehicle users of low-speed roadways. These barrier standards will be more aesthetic than standard barriers and scaled for an urban context. The research and approval process is ongoing.

**AASHTO Roadway Design Speed
Classification**

Low-speed is typically ≤ 45 mph

High-speed is typically ≥ 50 mph.

TDOT Standard Drawing S-SSMB-2 51" SINGLE SLOPE CONCRETE BARRIER WALL provides guidance on barrier design to delineate high-speed roadways (50 mph and above) from multi-use paths and sidewalks. When bicycle or pedestrian safety rails are needed to protect a pedestrian or bicycle facility from steep slopes, drop-offs, or other non-vehicular hazards, TDOT Standard Drawing S-BPR-1 BIKE/PEDESTRIAN SAFETY RAIL should be referenced.

[This page intentionally left blank]