



Department of  
**Environment &  
Conservation**

# Division of UST Tank School Presentation

Version 3.9  
April 12, 2023

# WEBEX TRAINING NAVIGATION EXAMPLE

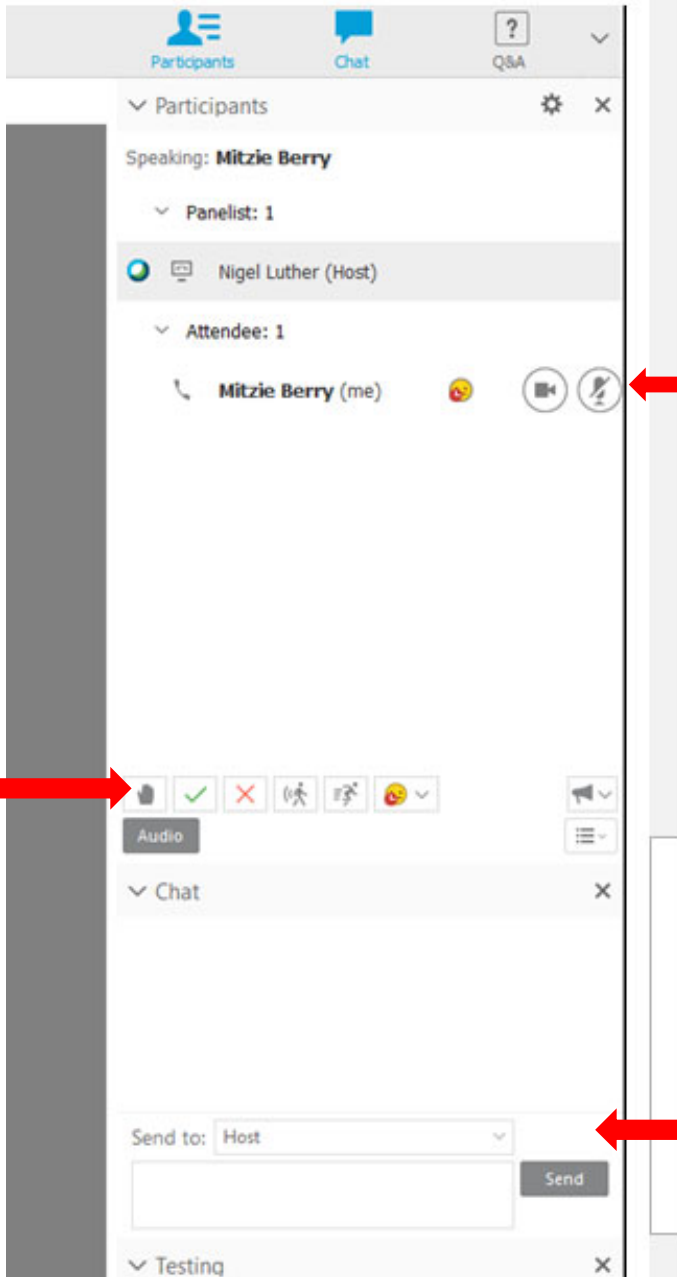

The screenshot shows the Webex training interface with several key sections and annotations:

- Participants Panel:** Located at the top, it shows the current speaker as **Mitzie Berry**. Below this, it lists participants: **Panelist: 1** (Nigel Luther (Host)) and **Attendee: 1** (Mitzie Berry (me)).
- Audio Controls:** A row of icons for audio management, including a hand icon for raising the hand, a microphone icon for muting, and a speaker icon for volume. A red arrow points to the hand icon with the text "RAISE YOUR HAND".
- Mute/Unmute Microphone:** A red arrow points to the microphone icon in the participant list with the text "MUTE/ UNMUTE YOUR MICROPHONE".
- Chat Section:** A text input field and a "Send" button are located at the bottom of the interface. A red arrow points to this section with the text "CHAT SECTION FOR QUESTIONS AND/OR PROBLEMS DURING CLASS".

# Introductions

- Instructor Introductions
  - -Mitzie Berry – Johnson City Environmental Field Office
  - -David Stone – Knoxville Environmental Field Office
  - -Jessica Hussey – Knoxville Environmental Field Office
  - -Casey Norris – Memphis Environmental Field Office
- Attendee Introductions
  - Goals for Tank School attendance
  - Specific topics of interest
  - Type of facility

# Class Agenda

Class is a full day (approximately 6-8 hours) with two 15-minute breaks and a 30-minute lunch break

In class discussions and questions are encouraged, and short polling questions will be given at the end of sections

Online attendance is monitored throughout the day

Final exam must be completed at the end of class and score a 70% or above to receive the A/B operator certificate

\*Failure to complete the post-test will result in a non-attendance of the Tank School class.

# Class Content

Tanks and Piping

Spill Prevention

Overfill Prevention

Corrosion Protection

Leak Detection

New Installation, Notification, and Motor Fuel  
Dispensers

TOS, and Record Keeping

Red Tags and Financial Responsibility

# Requirements After Class Completion

The A/B operator certificate will be emailed within two days of class completion.

If your attendance was to meet the A/B Operator requirement for your facility you **must** have an account and designate yourself as the A and B operator in **TN Tank Helper**. If you have difficulty or questions with TN Tank Helper and the operator designation process, please contact Travis Treece at 615-517-8098 or [travis.treece@tn.gov](mailto:travis.treece@tn.gov).

<https://tdec.tn.gov/tankhelper>

If your attendance was to satisfy a Division enforcement action requirement, your enforcement case manager will be notified of your class completion by the tank school coordinator.

If your attendance was to satisfy an operating retraining requirement from a recent operational compliance inspection, you **must** send a copy of your Tank School certificate to the inspector.

# Benefits of Compliance Training

- Greater awareness of compliance issues
- Better trained tank owners and operators
- Fewer operational compliance violations
- Greater protection for the environment
- To meet Operator Training/Re-training requirements

# UST Operator Training

- Each facility must have three classes of Operators:
  - **Class A** – overall responsibility for UST operation and maintenance
  - **Class B** – daily, on site responsibility for UST compliance
  - **Class C** – responsibility for release emergencies
- Specific training requirements for each Operator class.
- Tank owners must use the Tennessee Tank Helper online program to designate Class A and B Operators for each facility they own.

<https://tdec.tn.gov/tankhelper>



# 2022 Most Frequent Violations

- Failure to Conduct Spill Prevention Device Testing
- Failure to Conduct Overfill Prevention Device Testing
- Failure to Do Annual Line Tightness Test
- Failure to Maintain Monthly Tank Release Detection Records
- Failure to Maintain Three Years of Annual Electronic and Mechanical Release Detection Equipment Testing

These violations can be very costly to you...

# Some Common Civil Penalties

Violation	Civil Penalty
Failure to test spill prevention equipment	\$2,000 / tank
Failure to test overfill prevention equipment	\$2,000 / tank
Failure to conduct annual line tightness test	\$2,000 / line
Failure to have leak detection records (>4 months)	\$3,200 / tank
Failure to Maintain Three Years of Annual Electronic and Mechanical Release Detection Equipment Testing	\$200 / test
Failure to test cathodic protection	\$1,200 / CP test
Failure to report a suspected release	\$3,200 / event
Failure to test automatic line leak detector	\$2,000 / tank

**Failure to correct violations or pay penalties could result in your facility being red tagged.**

# 4 Things You Must Know:

- 1 What equipment is at your facility.
- 2 What must be done,
- 3 When it must be done,
- 4 What you must have for an inspection.

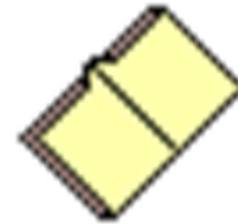

# Disclaimer

The State of Tennessee does not endorse any specific brands, manufacturers, or vendors of equipment, products or services.

Any brand names mentioned or depicted of any equipment, products, or services in this presentation are used for illustrative purposes only and are neither endorsements nor recommendations for such equipment, products, or services and shall not be construed as such.

# Testing Requirements- Qualifications

- All testing requirements must be conducted by a “qualified person” as defined by U.S. EPA:
  - 1) Licensed Contractor certified by device manufacturer
  - 2) Approved by authority having jurisdiction (Division of UST)
  - 3) Conducted in accordance with Division guidance and can demonstrate adequate experience
  - 4) Obtain certification from nationally recognized organization (PEI)

# Understanding Your UST System

Most Underground Storage Tank (UST) systems consist of:

- One or more underground tanks
- Piping
- Spill Prevention
- Overfill Prevention
- Corrosion Protection
- Leak Detection System

# Typical UST System

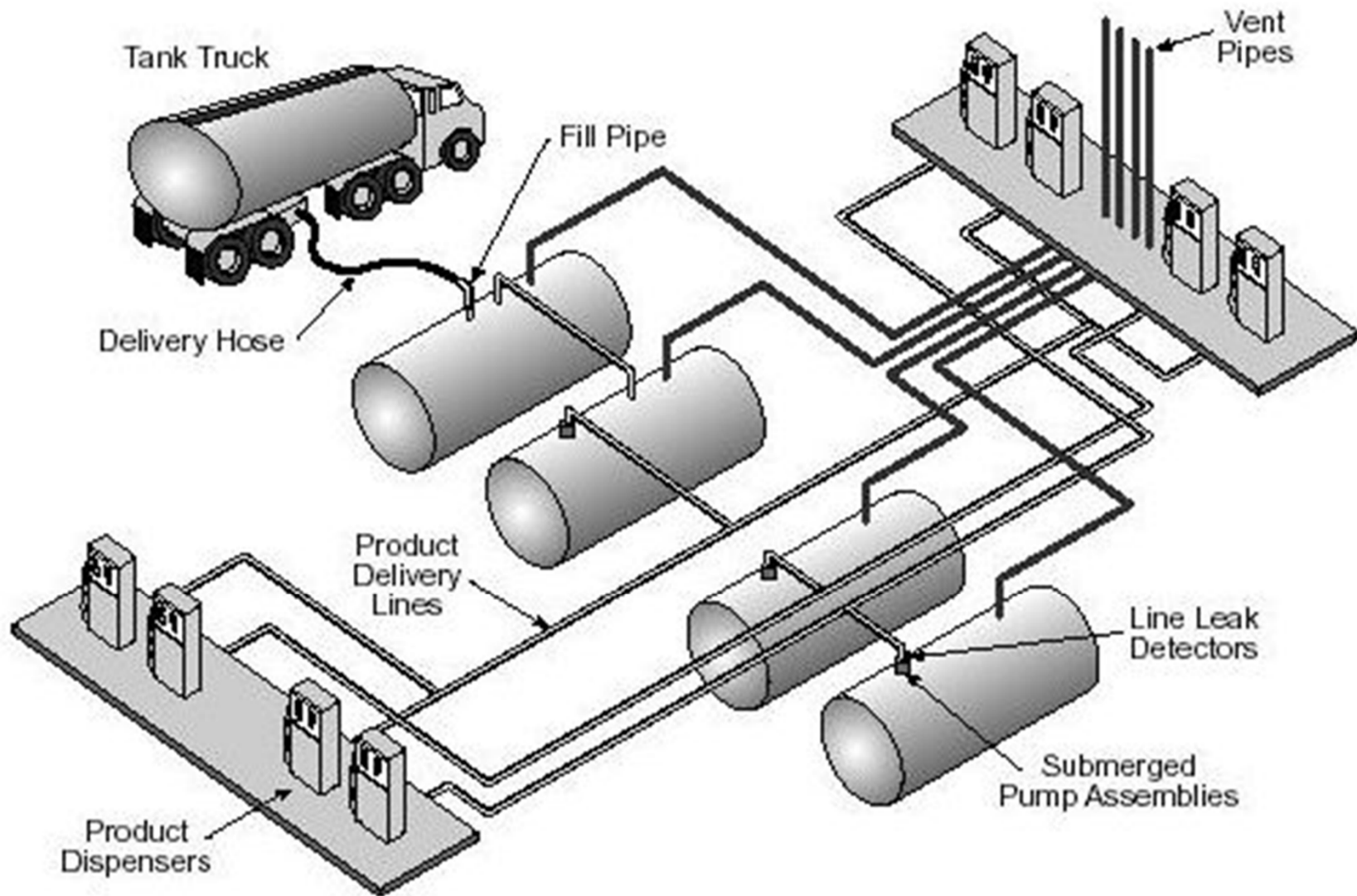

# Different Kinds of Tanks

- Metallic
  - Cathodically Protected Steel
- Non-Metallic
  - Fiberglass-clad Steel
  - Jacketed Steel
  - Fiberglass Reinforced Plastic (FRP)

\*Tanks may be single or doubled walled\*



# Metallic Tanks

- Sti-P3<sup>®</sup> tank- Has a dielectric coating on the outside and has galvanic (sacrificial) anodes attached to the outside of the tank.
- Bare Steel tank- No factory installed protection. Uses field installed corrosion protection.

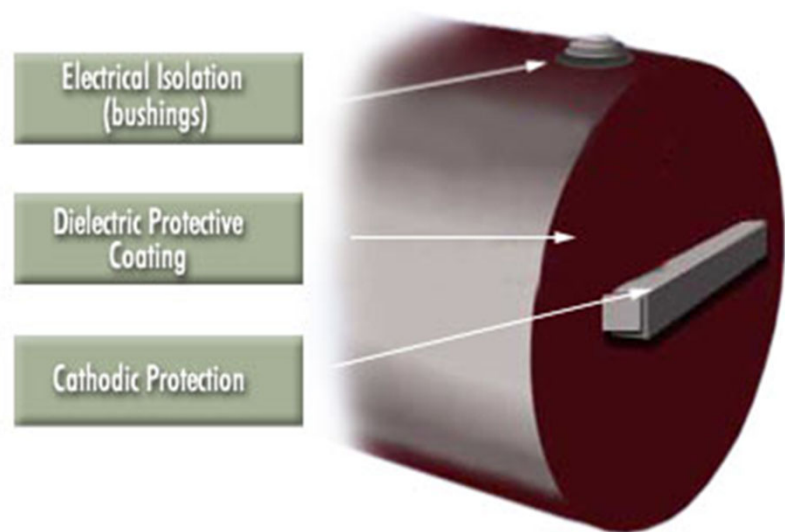

Sti-P3



Bare Steel

# Non-Metallic Tanks

- **Clad Steel Tank-** A steel tank that has a thick layer of non-corrodible material such as fiberglass or urethane mechanically bonded (clad) to the outside of the tank which keeps tank from corroding.
- **Jacketed Steel Tank-** A steel tank that is encapsulated (or jacketed) in a noncorrodible, nonmetallic material such as fiberglass or polyethylene.
- **Fiberglass Reinforced Plastic (FRP) Tank-** These tanks are made of fiberglass reinforced plastic.



Sample Clad Tank



Jacketed Tank



Fiberglass Reinforced Plastic (FRP) Tank

# Tank Configurations

- Compartment Tanks- are divided into two or more compartments. These usually hold different product grades.
- Manifolded Tanks- Two or more tanks connected by piping. These **always** hold the same product grade.

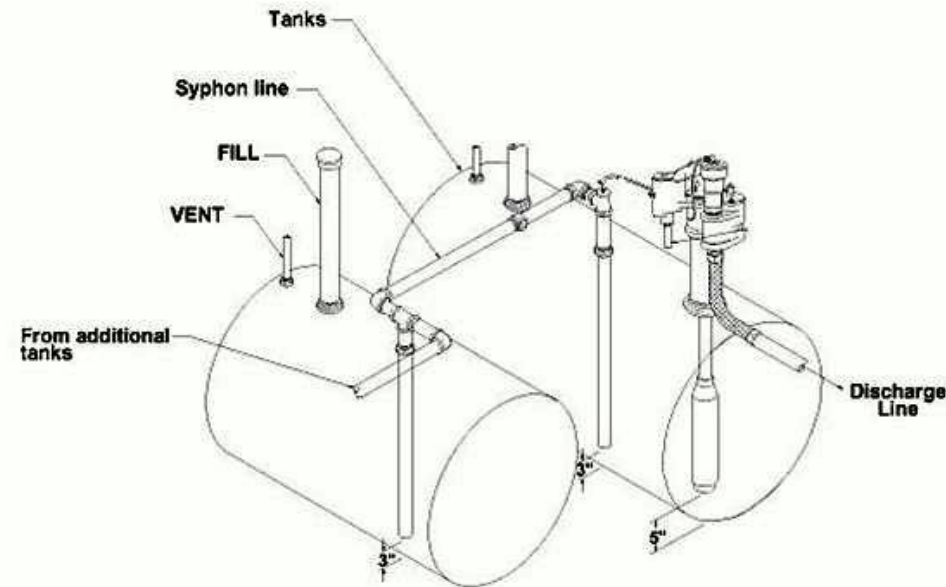
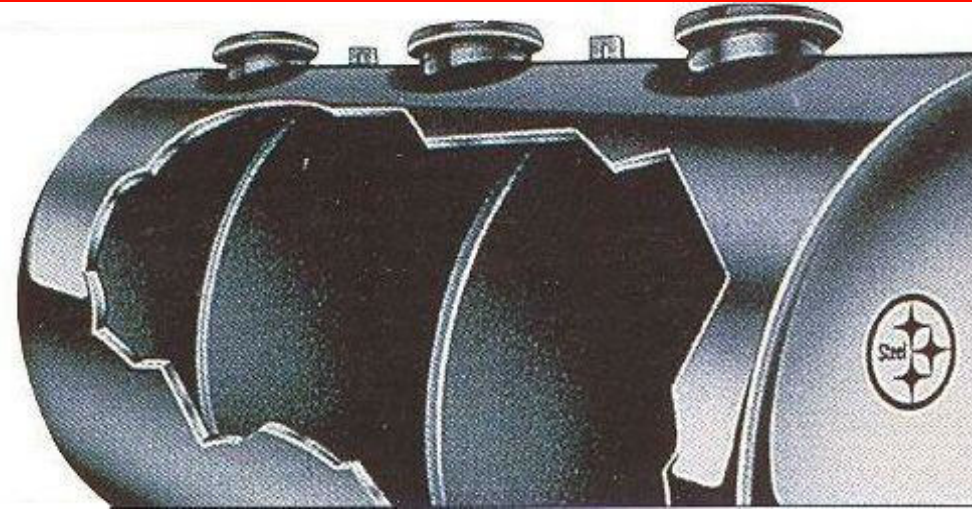

# Different Kinds of Piping

- Metallic
  - Cathodically Protected Steel
- Non Metallic
  - Fiberglass
  - Flexible Plastic
  - Rigid Plastic



# Examples of Non Metallic Piping

- **Fiberglass Reinforced Plastic Piping (FRP)**- is made of fiberglass reinforced plastic. It is rigid piping (not flexible).
- **Flexible Plastic Piping**- is composed of specially engineered Petroleum resistant polymers.
- **Semi-rigid piping**- is thicker than most flexible plastic piping and usually has electrofusion piping connections.



Sample FRP Piping



Sample Flexible Piping



Sample Semi- Rigid Piping

\*Piping may be single or doubled walled\*

# How Do You Know What Is Present?

- **Installation Records**

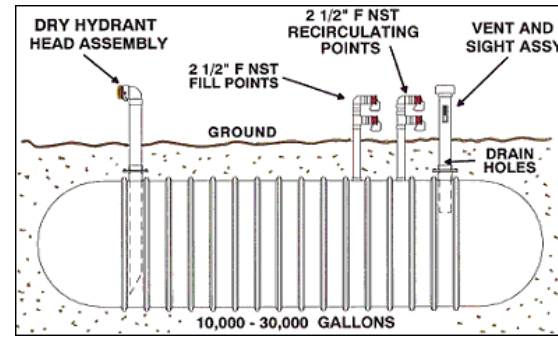

- **Visual observation**



- **Testing**



- **Previous Inspection Records**



# Can You Identify...?



# What Kind of Piping is This?





# We Have Covered...

✓ **Tanks and Piping**

**Next:  
Spill Prevention**

# What You Should Know About Spill Prevention

- Any tank filled with 25 gallons or more at one time MUST have spill prevention.
- Spill prevention devices must contain spills that may occur when the delivery hose is disconnected from the fill pipe.
- They are often called “spill buckets” or “catchment basins”.

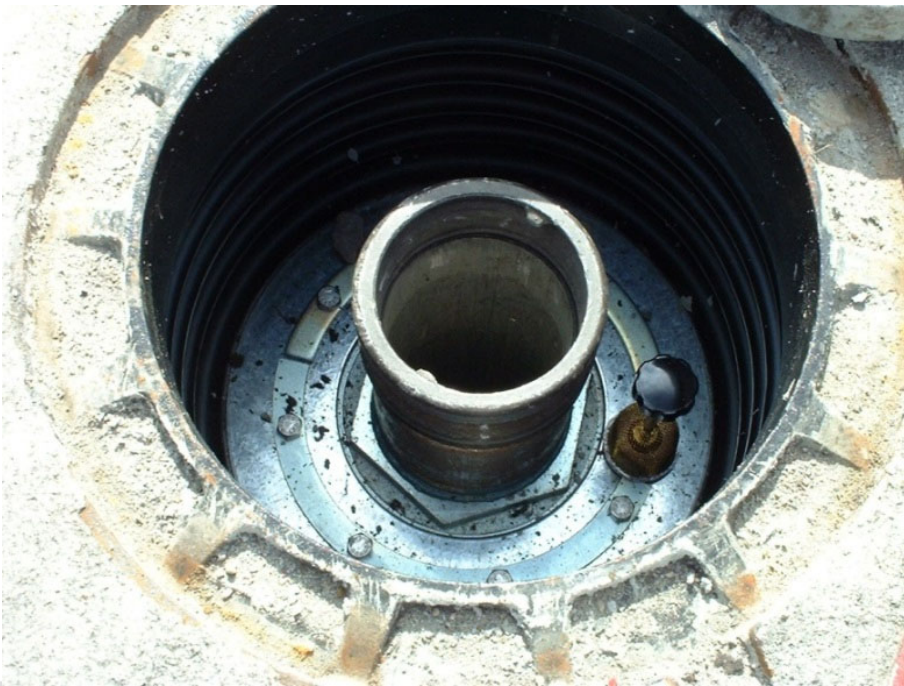

# What You Should Know About Spill Prevention

- Some have drain valves to allow product to drain into the tank.
- When spill bucket contents are drained into a tank, any collected water or debris may also enter the tank.

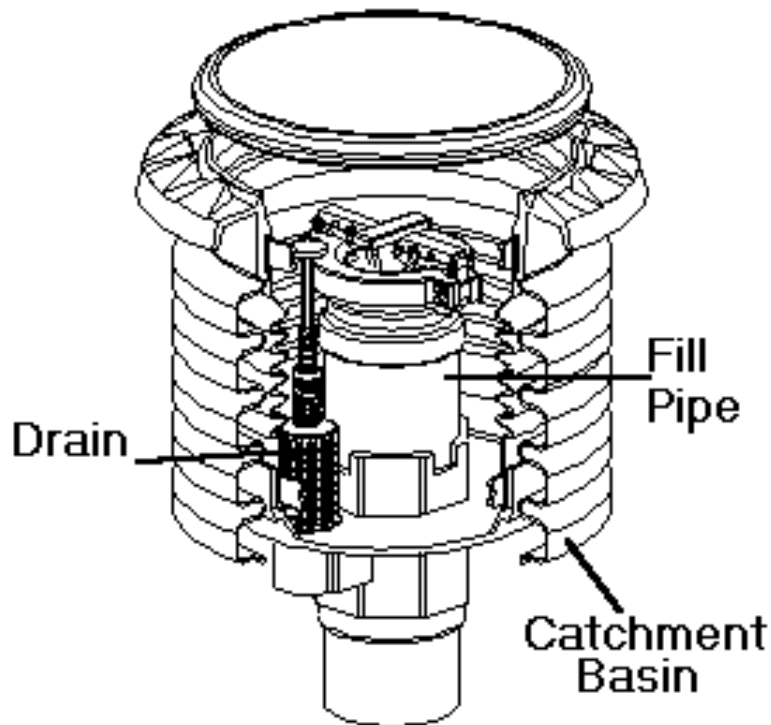

# Ethanol Blended Fuels

## Ethanol blended fuels:

- ✓ E 10 - up to 10% ethanol, most common fuel in TN.
- ✓ E 15 - beginning to be commercially available in TN.
- ✓ E 85 - limited availability in TN; for flex fuel vehicles only

**Very critical to keep water out of tanks**

storing ethanol blended fuels.

Excess water in tank can result in “phase separation” where water/ethanol separates from gasoline - fuel is out of specification and ruined.



# What You Should Know About Spill Prevention

- They are not designed to hold product for long periods of time.
- Spill buckets often have a shorter “life- span” than tanks or piping.
- Spill buckets must be visually inspected at least once per month.



# Why the Concern with Spill Buckets?

## UST Leak Sources in Florida

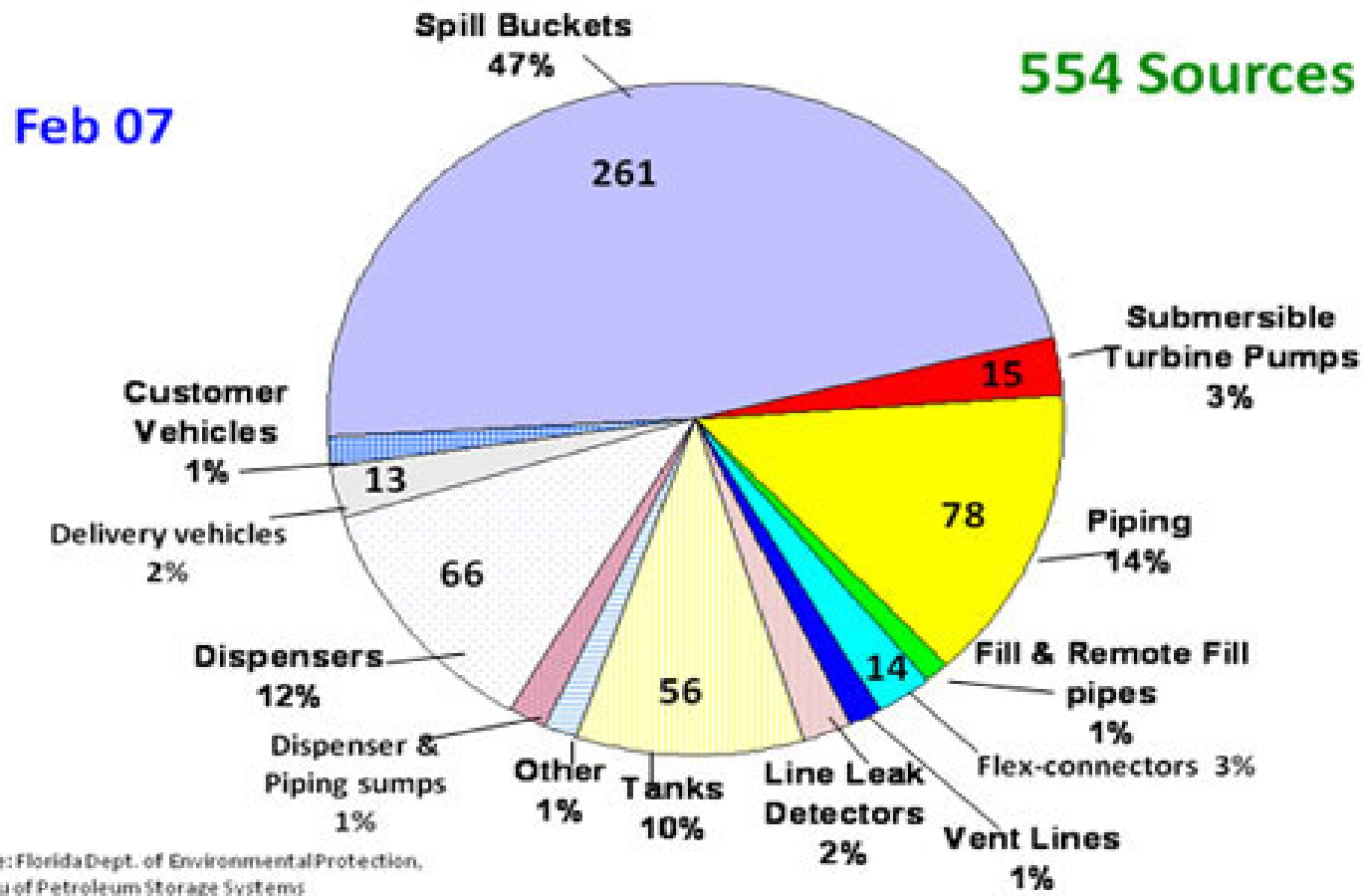

# Walkthrough Inspections- Spill Prevention

**Every 30 days:**

## **Inspect Spill Buckets**

- remove liquid or debris
- check for cracks or damage
- remove fill pipe obstructions
- Inspect fill cap for proper fitting and gasket
- record results on Division form or pre-approved alternate format



# Monthly Walkthrough Form-Spill Bucket

## MONTHLY/ANNUAL FACILITY WALKTHROUGH INSPECTION FORM

Use this form in place of: 1-Monthly Spill Bucket Log, 2-60-Day Record of Rectifier Operations Form, 3-Quarterly Dispenser Inspection Log, and 4-Monthly Electronic Interstitial Monitoring Alarm Report

Facility Name	<input type="text"/>	Address	<input type="text"/>	UST Facility ID	<input type="text"/>	YEAR	<input type="text"/>
---------------	----------------------	---------	----------------------	-----------------	----------------------	------	----------------------

**YOUR INITIALS OR SIGNATURE INDICATE THE DEVICE OR SYSTEM WAS INSPECTED AND SATISFACTORY.  
DOCUMENT ANY ACTIONS TAKEN IN RESPONSE TO UNUSUAL OPERATING CONDITIONS IN THE COMMENTS SECTION ON PAGE 4.**

### I. MONTHLY (EVERY 30 DAYS)

If your UST system receives deliveries at intervals greater than 30 days, you may check your spill prevention equipment prior to each delivery. Only complete the applicable release detection section at the top of page 2. Indicate any problems found, including tank number and product type in the COMMENTS / ACTIONS TAKEN section at the end of this document.

ACTIVITY	JAN	FEB	MAR	APR	MAY	JUN	JUL	AUG	SEP	OCT	NOV	DEC
Date of Inspection												
1. Visually check all spill prevention equipment for damage and remove all liquids and debris. Standalone Monthly Spill Bucket Inspection Log no longer required.												
2. Check for and remove obstructions in fill pipe.												
3. Check all fill caps to ensure it is securely on fill pipe and not in contact with the spill bucket lid.												



# Spill Prevention Device Testing

## Three Year Spill Prevention Integrity Testing

Spill Buckets must have an integrity test performed every three years. If the device fails, it must be replaced.

Spill Buckets must have an integrity test performed every 3 three years after the initial test.

Test must follow Division Guidance or National recognized testing protocol

**Double Wall Spill Bucket with IM Sensor- exempt from 3-year hydrostatic testing if sensor is installed in the annular space and monthly sensor records maintained.**

# Spill Prevention Device Hydrostatic Test



STATE OF TENNESSEE  
 DEPARTMENT OF ENVIRONMENT AND CONSERVATION  
 DIVISION OF UNDERGROUND STORAGE TANKS  
 William R. Snodgrass Tennessee Tower  
 312 Rosa L. Parks Avenue, 12th Floor  
 Nashville, TN 37243

SPILL PREVENTION DEVICE HYDROSTATIC TEST REPORT				
<ul style="list-style-type: none"> <li>▶ This form must be used in conjunction with <b>Technical Chapter 4.2 SPILL AND OVERFILL PREVENTION, APPENDIX 1 "Spill Prevention Device Hydrostatic Testing Procedures"</b>.</li> <li>▶ If a defective spill prevention device is discovered at any time, then the device shall be repaired or replaced.</li> <li>▶ The owner/operator shall notify the Division within 72 hours prior to any repair or replacement. <b>Repairs may only be made if allowed by the spill bucket manufacturer.</b></li> <li>▶ If a defective spill prevention device is replaced, a Division inspector should be present to determine if an environmental impact has occurred and if a site check will be required.</li> </ul>				
I. UST FACILITY INFORMATION		II. OWNER INFORMATION		
UST Facility ID #	<input type="text"/>	Name/Company:	<input type="text"/>	
Facility Name:	<input type="text"/>	Address:	<input type="text"/>	
Address:	<input type="text"/>	City:	<input type="text"/>	State: <input type="text"/> Zip: <input type="text"/>
City:	<input type="text"/>	County:	<input type="text"/>	Phone Number: <input type="text"/>
III. TESTER INFORMATION				
Name:	<input type="text"/>	Company Address:	<input type="text"/>	
Title/Position	<input type="text"/>	City:	<input type="text"/>	State: <input type="text"/> Zip: <input type="text"/>
Company Name:	<input type="text"/>	Phone Number:	<input type="text"/>	
IV. TEST RESULTS				
Spill Device ID	Initial Reading	Final Reading (allow at least one hour)	Difference (>1/8 inch is FAIL)	Pass/Fail
Example: Tank 1A Premium	8 1/4 in.	8 1/4 in.	0 in.	Pass
Example: Tank 2A Diesel	7 1/2 in.	7 in.	1/2 in.	Fail
<input type="text"/>	<input type="text"/>	<input type="text"/>	<input type="text"/>	<input type="text"/>
<input type="text"/>	<input type="text"/>	<input type="text"/>	<input type="text"/>	<input type="text"/>
<input type="text"/>	<input type="text"/>	<input type="text"/>	<input type="text"/>	<input type="text"/>
<input type="text"/>	<input type="text"/>	<input type="text"/>	<input type="text"/>	<input type="text"/>
<input type="text"/>	<input type="text"/>	<input type="text"/>	<input type="text"/>	<input type="text"/>
<input type="text"/>	<input type="text"/>	<input type="text"/>	<input type="text"/>	<input type="text"/>
<b>NOTE: Use as many copies of this form as needed. Each copy must also be signed as required below.</b>				
Tester's Signature/Date: _____		Tester's Name Printed _____		
Owner/Operator Signature/Date: _____		Owner/Operator's Name Printed _____		

CN-1366 (Rev. 11-15)

RDA 2304

# What Should You Do?

- Conduct integrity testing of spill bucket
  - Follow Division guidance or PEI - RP1200 Guidance
  - Pass = no replacement; Fail = replace the spill bucket
- Spill bucket replacement-
  - If contamination is found, report as a suspected release.
- Repair spill bucket
  - Only in accordance with manufacturer's recommendations.
    - Spill bucket liners not approved by most spill bucket manufacturers.

# What's Wrong With This?



# We Have Covered...

- ✓ **Tanks and Piping**
- ✓ **Spill Prevention**

**Next:**  
**Overfill Prevention**

# Overfill Prevention

Any tank that is filled with **25 gallons or more** *at one time* MUST have overfill prevention.

Overfill prevention must prevent tanks from being overfilled during delivery.

Overfill prevention is designed to either:

1. stop product flow, or
2. reduce product flow, or
3. alert the delivery person before the tank becomes full and begins releasing product

# 3 Types of Overfill Prevention

The 3 most common types of overfill prevention:

- 👉 Automatic Shutoff (sometimes called 'flapper valves')
- 👉 Flow Restriction (sometimes called 'ball floats')
- 👉 Overfill Alarm (sometimes called 'high level alarms')

Let's examine each type...

# Automatic Shutoff Devices

- An **automatic shutoff device** or “flapper valve” slows down and stops product flow when the product has reached a certain level in the tank.
- Automatic shutoff devices are located **in the fill pipe.**

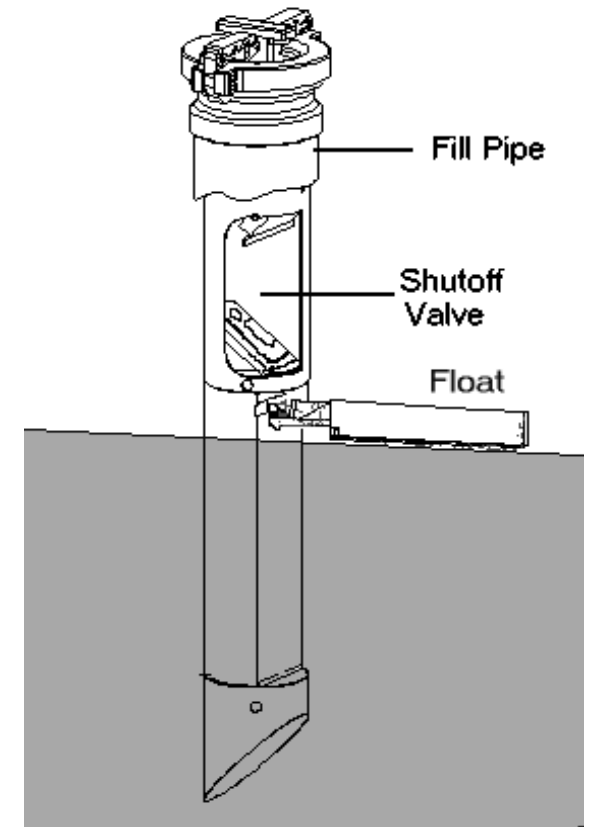
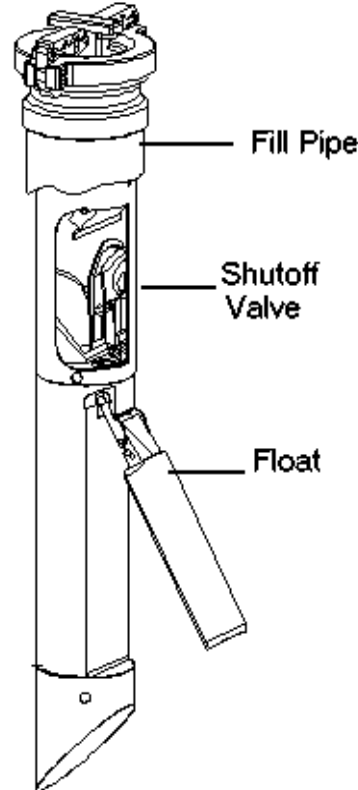



# Automatic Shutoff Devices

- These devices normally stop product flow when tank is **95%** full.
- Look down the fill pipe to see part of this device.
- You will see what appears to be a line cutting through the fill pipe (or a half moon shape in your fill pipe).



Looking Through The End Of  
Automatic Shutoff Device

**Shutoff Device**

# Examples of Automatic Shutoff Devices



# What we don't want to see...

If a Tank Gauging stick is left in the fill pipe, then overfill prevention is disabled for these tanks



This is a **felony** under Tennessee state law

# Short Pause...

Are there any questions about...

Flapper Valves?

# Ball Float Valves

- A ball float valve is located inside the tank in the vent piping.



Sample  
Ball Float  
Valve



# How Ball Float Valves Work

As the tank fills, a ball in the valve rises and restricts the flow of vapors out of the tank.

The flow rate decreases and alerts the delivery person to stop the delivery.

Ball float valves engage when the tank is **90%** full.

## Ball Float Valves in Open and Closed Positions

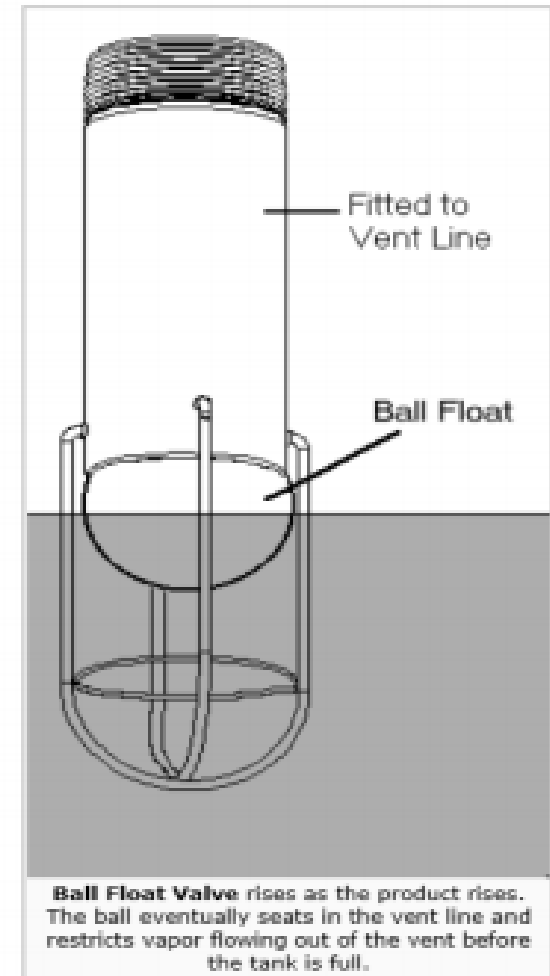
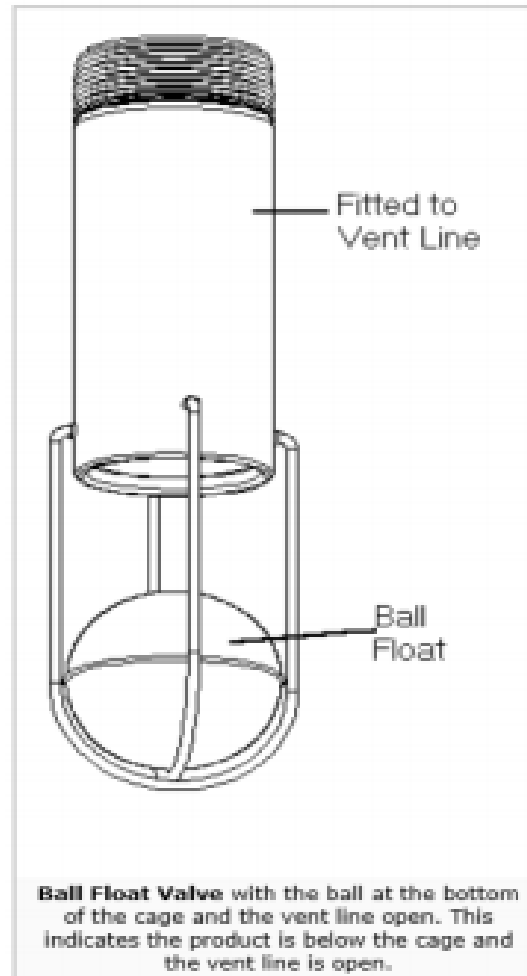

# Ball Float Valves

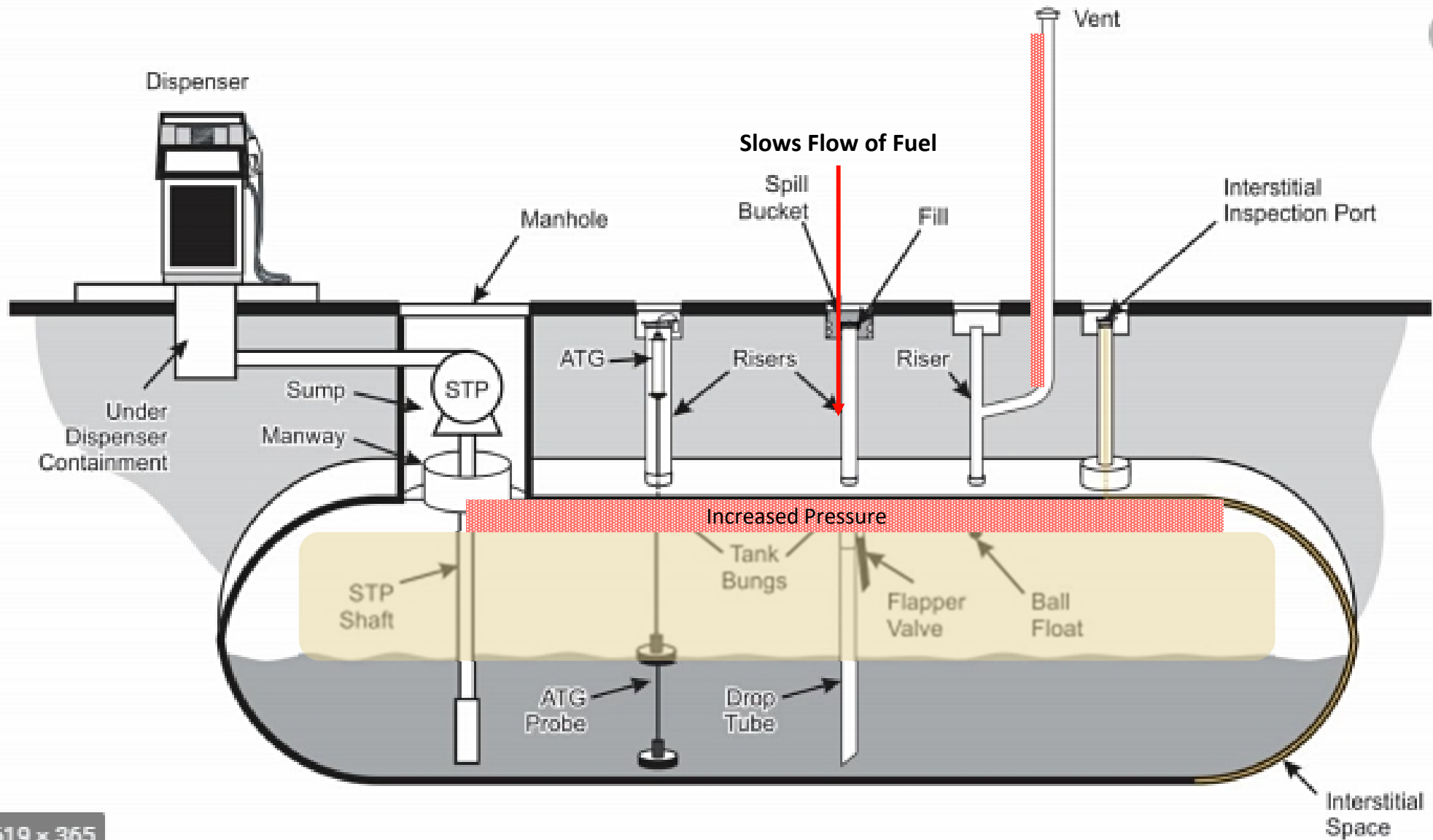

619 x 365

# Location of Ball Float Valves





# Damaged Ball Float Valve

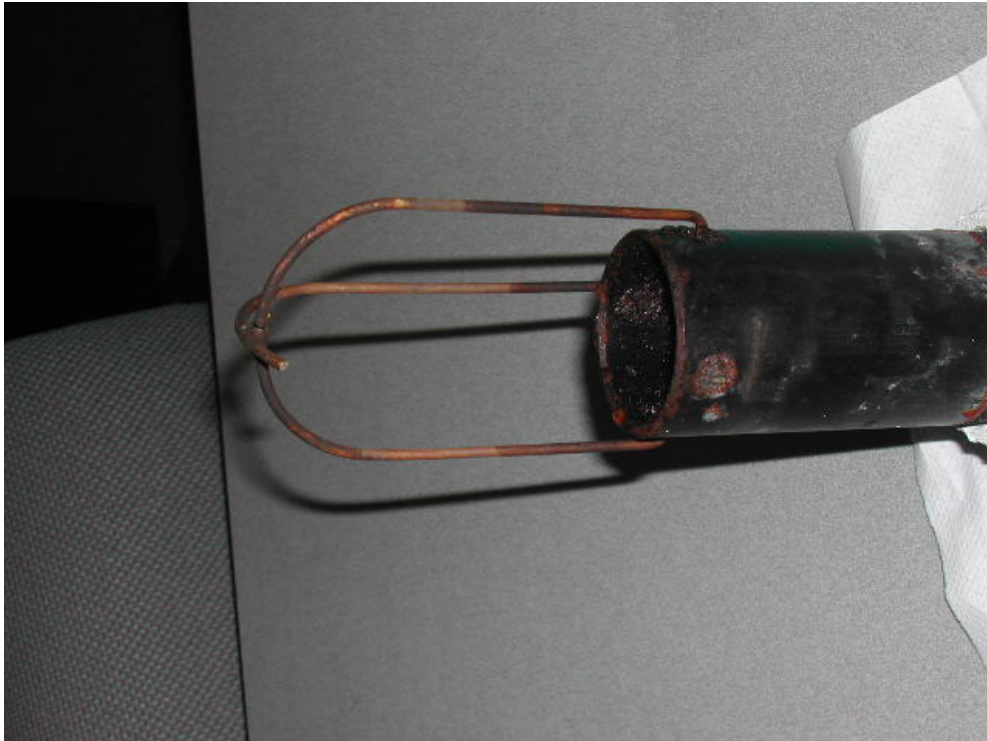

Wire restraining cage is broken and ball is missing.



Wire restraining cage is loose

# Ball Float Valves

- Flow restriction devices (Ball float valves) used for overflow prevention can not be replaced if found damaged or non-functional.
- If ball floats are found damaged or non-functional during overflow functionality testing then a new method of overflow must be installed.

# Short Pause...

**Are there any questions about...**

**Ball Float Valves?**

# Overfill Alarms

- An **overfill alarm** uses a sensor in the tank located on the automatic tank gauge (ATG) probe.
- An overfill alarm provides **a warning** when the tank is close to being full that can be seen or heard (or both) by the delivery person.
- When the alarm activates, the **delivery person** should **stop the flow** of product to the tank **immediately**.

# Examples of Overfill Alarms

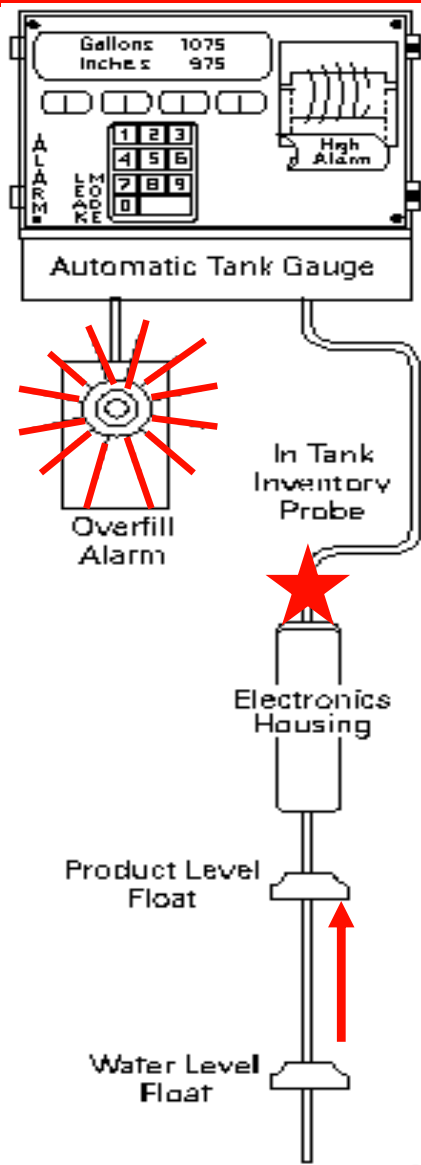

**These signaling devices must be located where the delivery driver can see and hear them to know when to stop product delivery**



Sample Overfill Alarm



**If delivery is not stopped quickly after alarm sounds, it is possible the tank could be overfilled**

# Short Pause...

## Are there any questions about...

### Overfill Alarms?

# Overfill Device Inspections

- Inspect overfill prevention equipment for functionality every 3 years.
- Maintain overfill functionality inspection records conducted within the last three years.
- Applies to all forms of overfill when more than one device is installed.

Overfill device inspection documentation must be maintained for **three years.**

# Automatic Shutoff Device Testing

- 1) Remove drop tube and flapper from the tank
- 2) Visually inspect for damage
- 3) Remove debris which may prevent function
- 4) Verify float mechanism moves freely
- 5) Move float to shutoff position, verify device will move into the path of product flow
- 6) Measure height of activation
- 7) Measure diameter of tank
- 8) Verify device will shut off flow at 95% of tank capacity
- 9) Return to service or replace as needed





# Flow Restriction Device Testing

- 1) Remove from tank
- 2) Inspect tank top fittings
- 3) Measure diameter of tank
- 4) Measure length of extractor
- 5) Verify 90% setting
- 6) Float mechanism moves freely
- 7) Remove any debris which prevents device from functioning
- 8) Return to tank if device passes
- 9) Replace with auto shutoff or alarm if device fails
- 10) Repair and retrofit of ball float valves is not allowed



# Overfill Alarm Device Testing - Summary

1. Remove the electronic alarm probe device from the tank and visually inspect for damage or corrosion.
2. Ensure the device functions correctly by causing an overfill alarm condition by sliding the float along the probe shaft.
3. Determine the tank volume by tank calibration charts, ATG setup or manually to ensure that the electronic alarm device activates at 90% tank capacity.
4. Ensure that alarm is both audible and visible by the delivery person as an overfill alarm.
5. Reinstall the electronic alarm device in accordance with the manufacturer's installation instructions.
6. Attach Electronic Alarm printout (if applicable) from ATG showing overfill alarms that occurred during testing

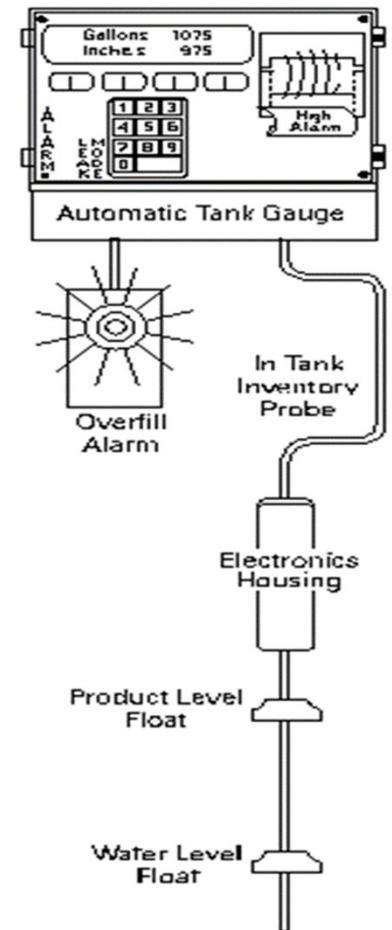

# UST Overfill Prevention Operability Test

 DEPARTMENT OF ENVIRONMENT AND CONSERVATION DIVISION OF UNDERGROUND STORAGE TANKS William R. Snodgrass TN Tower 312 Rosa L. Parks Avenue, 12th Floor Nashville, TN 37243 (615) 532-1945		UST OVERFILL PREVENTION OPERABILITY TEST			
<ul style="list-style-type: none"> <li>Inspection of all overfill devices is required at installation and at least once every 3 years thereafter.</li> <li>In the absence of a recognized industry procedure or manufacturer's recommended practice the "UST Overfill Device Inspection Procedure" may be utilized.</li> <li>Ball float valves must be replaced with a different overfill method if the device is found to be inoperable or set at the incorrect activation height.</li> <li>All overfill prevention devices installed after October 13, 2018, must be automatic shutoff devices or electronic alarm.</li> </ul>					
UST Facility			Person Conducting Inspection		
Facility Name		UST Facility ID #	Inspector's Name		Date of Inspection
Facility Address			Company		
City	County		Email	Phone Number	
UST Owner			Signature		Date
Inspection Results for the Year			Date Next Test is Due		
UST Division notification tank ID# and product stored					
Tank volume (gallons)					
Tank diameter (inches)					
Overfill device present <input type="checkbox"/> Yes <input type="checkbox"/> No <input type="checkbox"/> Yes <input type="checkbox"/> No <input type="checkbox"/> Yes <input type="checkbox"/> No <input type="checkbox"/> Yes <input type="checkbox"/> No					
Overfill device manufacturer					
Overfill device model					
Device is new <input type="checkbox"/> Yes <input type="checkbox"/> No <input type="checkbox"/> Yes <input type="checkbox"/> No <input type="checkbox"/> Yes <input type="checkbox"/> No <input type="checkbox"/> Yes <input type="checkbox"/> No					
Device in good condition (note criteria in inspection procedure) <input type="checkbox"/> Yes <input type="checkbox"/> No <input type="checkbox"/> Yes <input type="checkbox"/> No <input type="checkbox"/> Yes <input type="checkbox"/> No <input type="checkbox"/> Yes <input type="checkbox"/> No					
Ball Float Valve	All accessible tank top fittings are tight <input type="checkbox"/> Yes <input type="checkbox"/> No <input type="checkbox"/> Yes <input type="checkbox"/> No <input type="checkbox"/> Yes <input type="checkbox"/> No <input type="checkbox"/> Yes <input type="checkbox"/> No				
	Tank does NOT have a suction or tank syphon line installed <input type="checkbox"/> Yes <input type="checkbox"/> No <input type="checkbox"/> Yes <input type="checkbox"/> No <input type="checkbox"/> Yes <input type="checkbox"/> No <input type="checkbox"/> Yes <input type="checkbox"/> No				
	Standard drop tubes are installed & in good condition <input type="checkbox"/> Yes <input type="checkbox"/> No <input type="checkbox"/> Yes <input type="checkbox"/> No <input type="checkbox"/> Yes <input type="checkbox"/> No <input type="checkbox"/> Yes <input type="checkbox"/> No				
	Length of ball float valve (inches)				
	Height of tank top manway (if applicable) (inches)				
Drop Tube Device	Distance below top of tank that ball float valve is set (inches)				
	Indicate tank capacity when flow restriction occurs (%)				
	Complete shut off occurs below any ball float nipple in the tank <input type="checkbox"/> Yes <input type="checkbox"/> No <input type="checkbox"/> Yes <input type="checkbox"/> No <input type="checkbox"/> Yes <input type="checkbox"/> No <input type="checkbox"/> Yes <input type="checkbox"/> No				
	Assembly and all gaskets/seals in good condition <input type="checkbox"/> Yes <input type="checkbox"/> No <input type="checkbox"/> Yes <input type="checkbox"/> No <input type="checkbox"/> Yes <input type="checkbox"/> No <input type="checkbox"/> Yes <input type="checkbox"/> No				
	Length of upper tube to the "reference point" (inches)				
	Length of fill riser pipe (seating position to tank top) (Inches)				
	Height of tank top manway (if applicable) (inches)				
	Distance below tank top where "reference point" is located (Inches)				
Electronic Alarm	Distance between Reference Point and Complete Shut off Point				
	Distance below tank top where complete shut off occurs (inches)				
	Indicate tank capacity when complete (2 <sup>nd</sup> stage) shut off occurs (%)				
	Alarm is both audible and visible to delivery driver <input type="checkbox"/> Yes <input type="checkbox"/> No <input type="checkbox"/> Yes <input type="checkbox"/> No <input type="checkbox"/> Yes <input type="checkbox"/> No <input type="checkbox"/> Yes <input type="checkbox"/> No				
	Distance below top of tank that electronic alarm is set (inches)				
Indicate tank capacity when alarm occurs (%)					
ATG printout attached <input type="checkbox"/> Yes <input type="checkbox"/> No <input type="checkbox"/> Yes <input type="checkbox"/> No <input type="checkbox"/> Yes <input type="checkbox"/> No <input type="checkbox"/> Yes <input type="checkbox"/> No					
<b>Inspection result (Pass/Fail)</b>					
<b>Comments:</b>					
Alternative methods include: precision type ball float valves that are set to restrict flow at a height greater than 90% tank capacity or drop tube devices are set to completely shut off flow at a height greater than 95% tank capacity.					
Any device using an Alternative Method must have pg. 2 of this form completed prior to 10/13/2021. No device will be allowed to pass using Alternative Method if there is NOT a completed form for a (device) dated prior to 10/13/2021.					

CN-2584

1

RDA-2304

# Spill and Overfill Equipment Repairs

- Test or inspect components within 30 days after a repair to spill or overfill prevention equipment.
- Maintain documentation of testing conducted within 30 days of a repair to spill and overfill equipment.
- Ball Float devices may not be repaired or replaced.

# Overfill Prevention

There is one means of overfill prevention that  
always works.....

and we haven't discussed it.

Do you know what it is?

# Overfill Prevention

0400-18-01-.02(3)(b)

For as long as the UST system is used to store petroleum, owners and/or operators shall ensure that releases due to spilling or overfilling do not occur.

The owner and/or operator shall ensure that the volume available in the tank is greater than the volume of petroleum to be transferred to the tank before the transfer is made and that the transfer operation is monitored constantly to prevent overfilling and spilling.

# Calculating Delivery Amounts

## Problem

**Owner has:**

**10,000 gallon tank with  
Flapper valve overfill device,**

**5000 gallons of product  
remaining in tank**

**What is the maximum amount  
of fuel that should be ordered?**

# Calculating Delivery Amounts

## Problem

Owner has:  
10,000 gallon tank with  
Flapper valve overfill device,  
5000 gallons of product  
remaining in tank

What is the maximum amount  
of fuel that should be ordered?

## Solution

10,000 gallon tank  
– 5,000 gallons remaining in tank  
5,000 gallons ullage

Flapper valve overfill device activates  
when tank is 95% full, so 5% of 10,000 =  
500 gallon space which cannot be used

5,000 gallons ullage  
– 500 gallons  
4,500 gallons maximum



# Complete Spill and Overfill Poll

- Please complete polling questions on bottom right of screen.

# We Have Covered...

- ✓ **Tanks and Piping**
- ✓ **Spill Prevention**
- ✓ **Overfill Prevention**

**Next:**  
**Corrosion Protection**

# Corrosion Protection For Tanks and Piping

## All regulated underground tanks *and piping* must be protected from corrosion

- Portions of UST systems in contact with soil and/or water must be corrosion protected.
- Water as well as petroleum must be removed from sumps.

Some kinds of underground tanks and piping do not need *additional* corrosion protection.

# Tanks that do **NOT** need Additional Corrosion Protection

- ✓ Fiberglass-clad Steel
- ✓ Jacketed Steel
- ✓ Fiberglass Reinforced Plastic (FRP)



# Piping that does **NOT** need Additional Corrosion Protection



Fiberglass Piping



Flexible plastic piping

# Other UST Components that **DO** require Additional Corrosion Protection

- Steel Flex Connectors
- Remote fill piping
- Steel manifold siphon piping

# These Components Need Additional Corrosion Protection

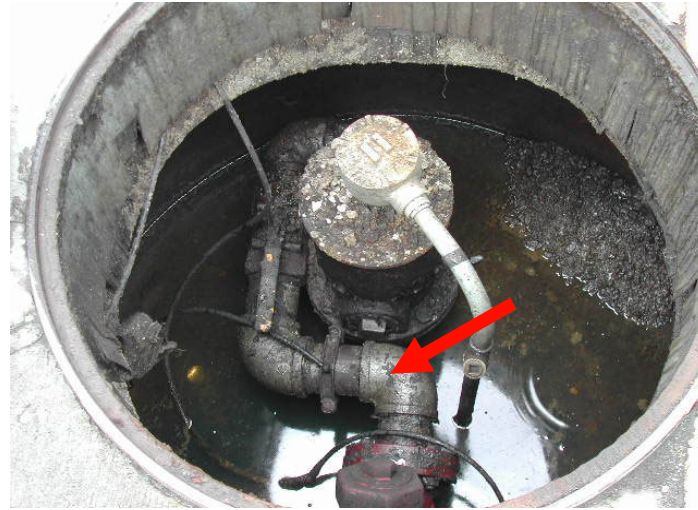

Metallic components must be corrosion protected

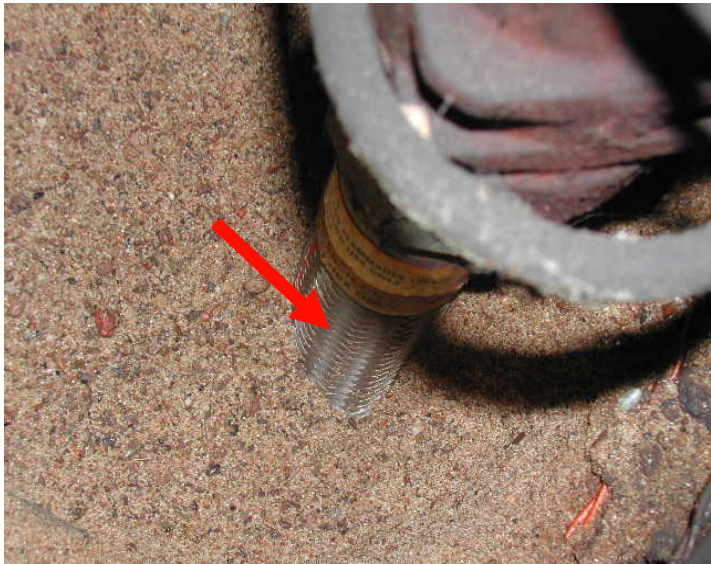

# Here is Why: Steel Corrodes

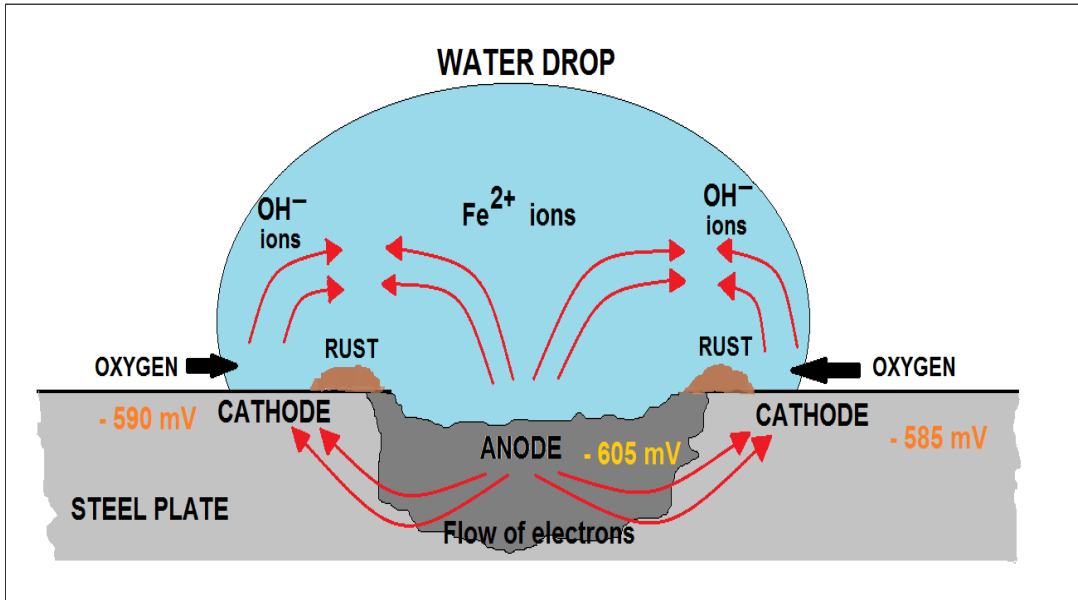

“point corrosion” acts like a drill on metal surfaces



# Here is Why: Steel Corrodes

Anode gives up electrons / cathode receives electrons

- What we want!

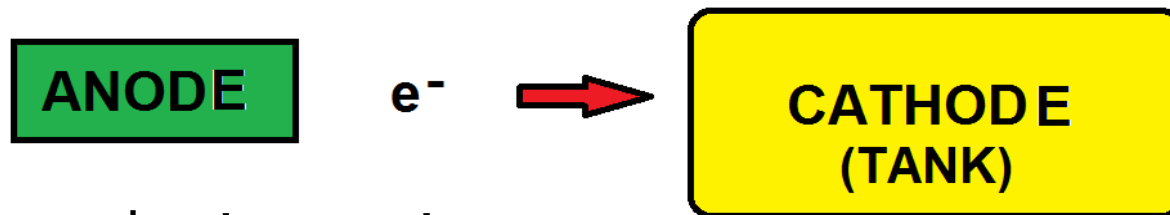

- What we don't want!

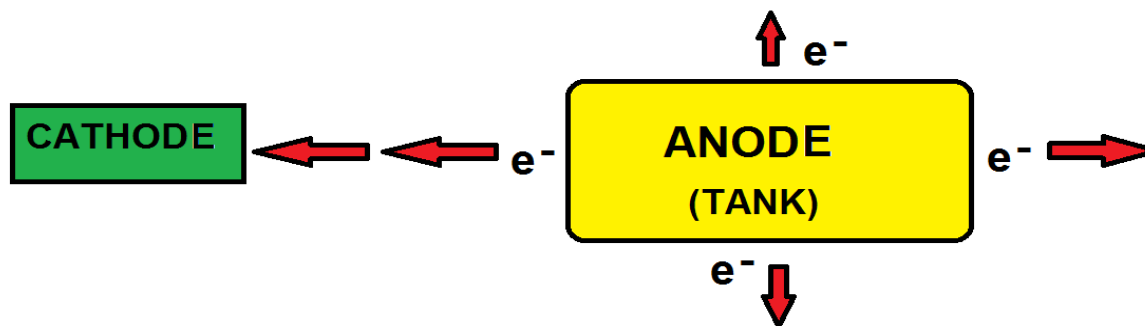

# 3 ways to Achieve Corrosion Protection

1. Passive Method: Galvanic (Sacrificial Anodes)
2. Active Method: Impressed Current (Rectifier)
3. Isolation (Boots or sumps for flex connectors)

# 3 Ways Controlling Corrosion

- Isolation methods
- Passive methods – sacrificial anodes (Galvanic System)
- Active methods – Impressed Current System

# Galvanic (Sacrificial Anodes)

**Galvanic systems** use buried anodes attached to underground tanks or piping.

A galvanic system cannot be seen.

There is no rectifier in a galvanic system.



# Galvanic (Sacrificial Anodes)

Anodes are installed on tanks at the factory (such as on the sti-P3® tank) and can be installed on piping and other underground metal components in the field.



Bag anodes attached to metal piping



# Impressed Current System

**Impressed current** cathodic protection systems use a **rectifier** to provide current to the tank, piping, or other components for corrosion protection.

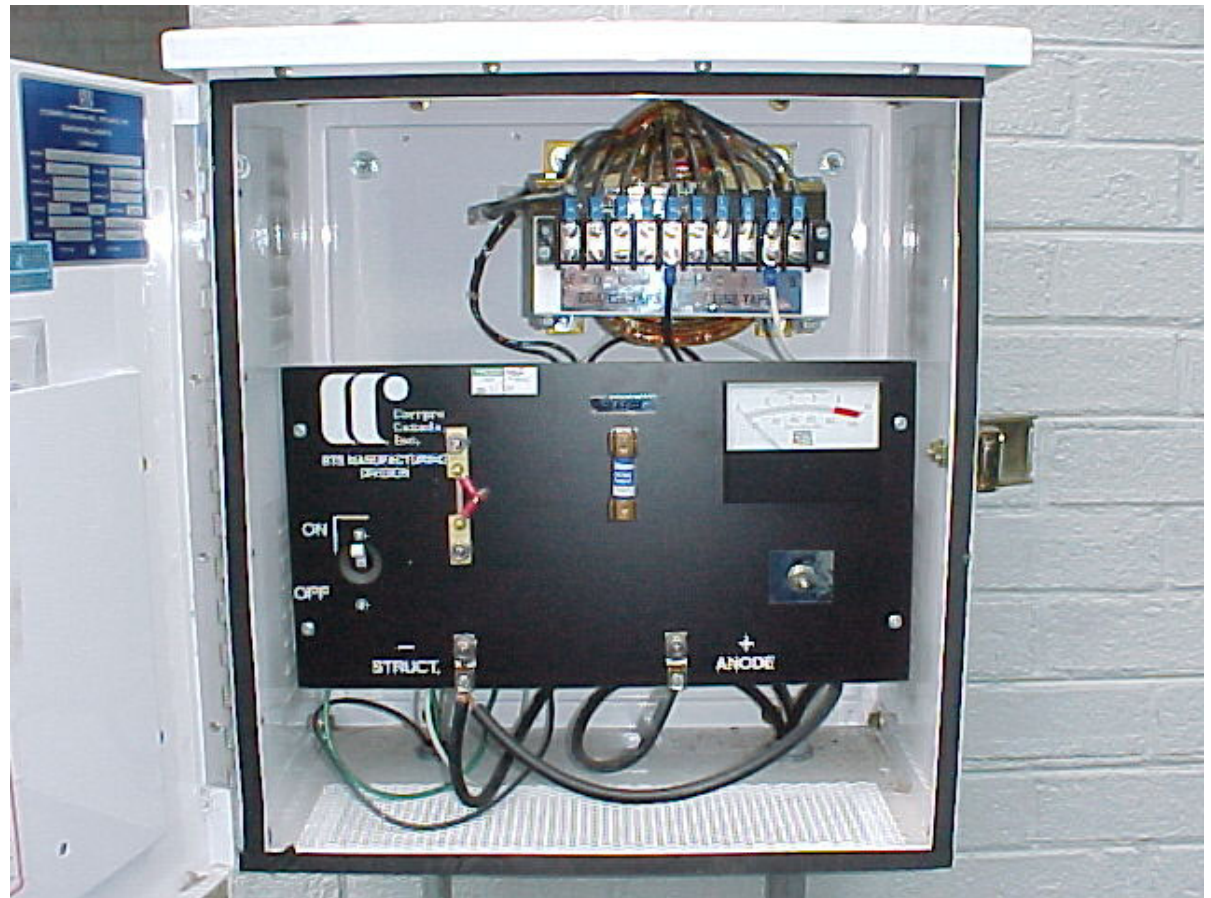

# Impressed Current System

- The rectifier is always located somewhere at the facility. It may be found inside or outside the building.



Sample Rectifier



# CP System Power

The Impressed Current Cathodic Protection system should be on a separate circuit from other electrical components

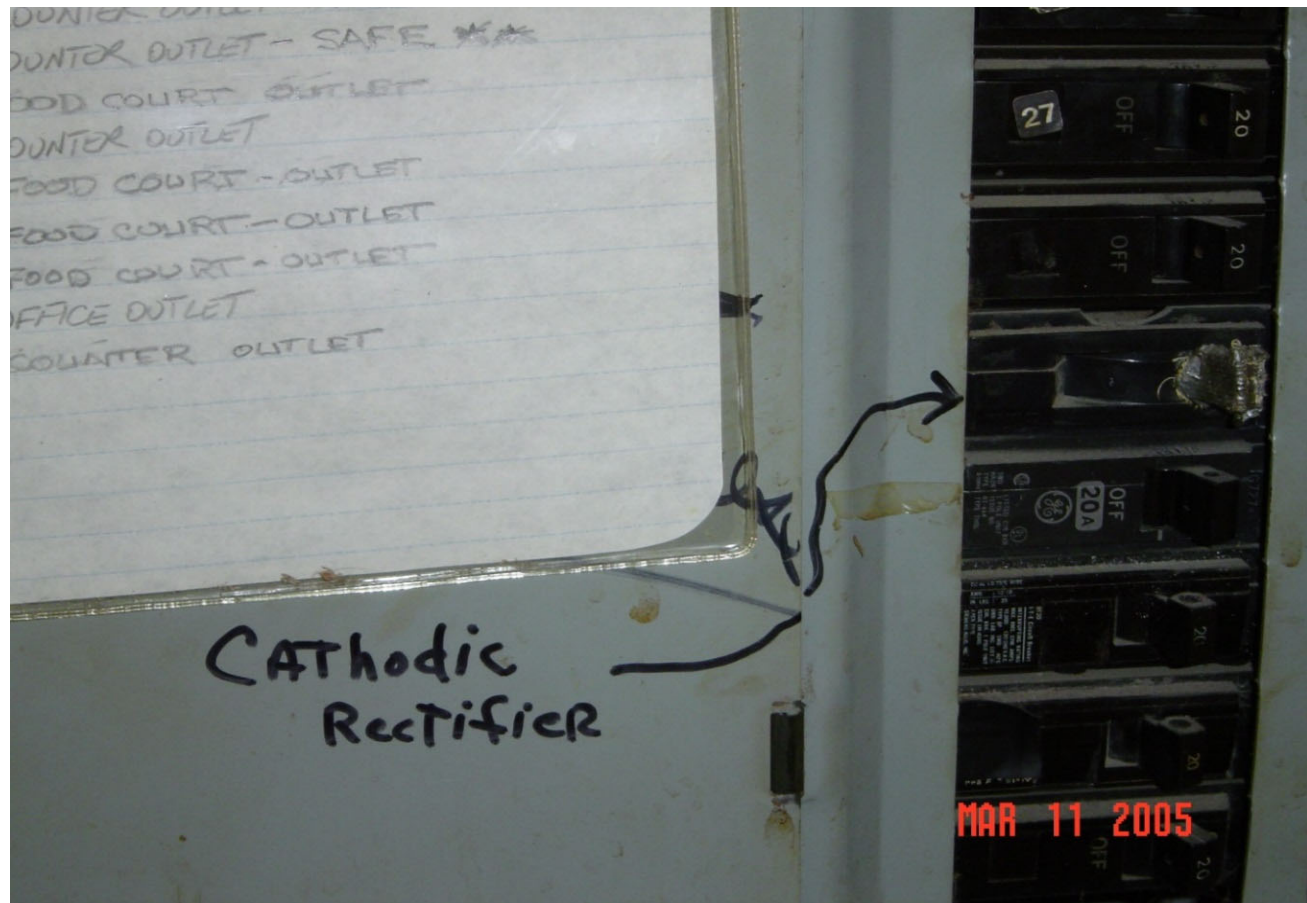



# Impressed Current System

- Electric power to the rectifier must be **on** continuously.
- Impressed current cathodic protection systems are always installed in the field.

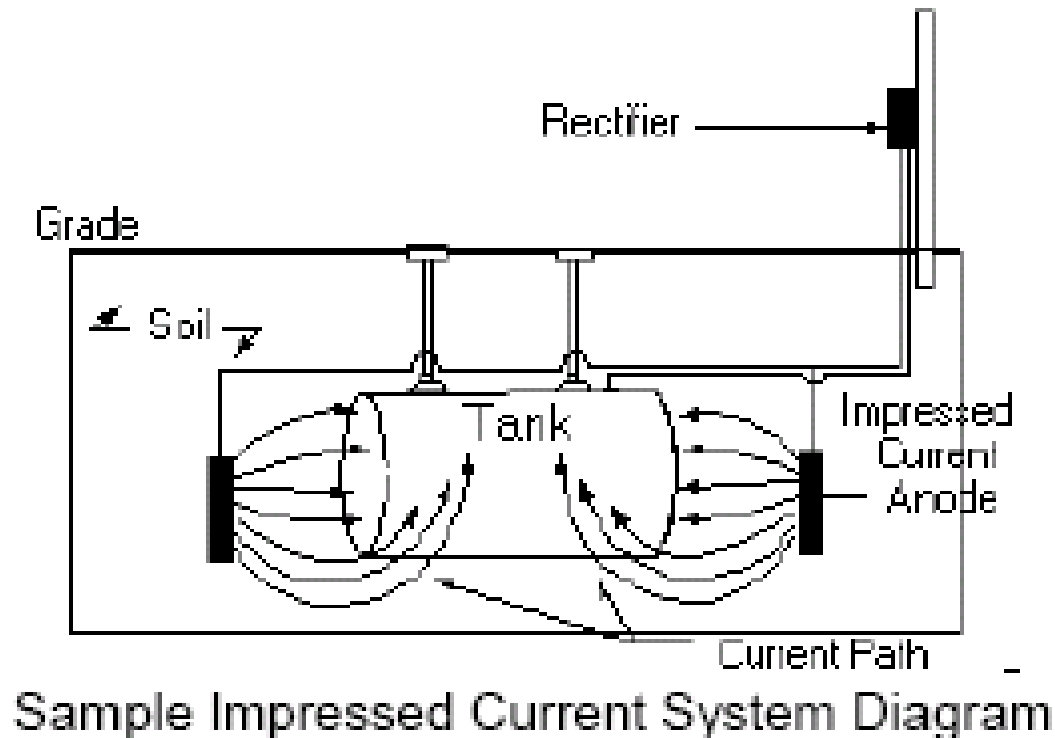

# Steel Flex Connectors

Steel **flex connectors** must be protected from corrosion

Isolate the flex connector from contact with soil and water by putting **a protective covering or boot** on the flex connector,

OR...

**shrink wrap boot  
isolates flex connector  
from soil**



# Steel Flex Connectors

Remove soil and/or water in contact with flex connector or metal piping



Any water in sump must not be in contact with flex connector or metal piping

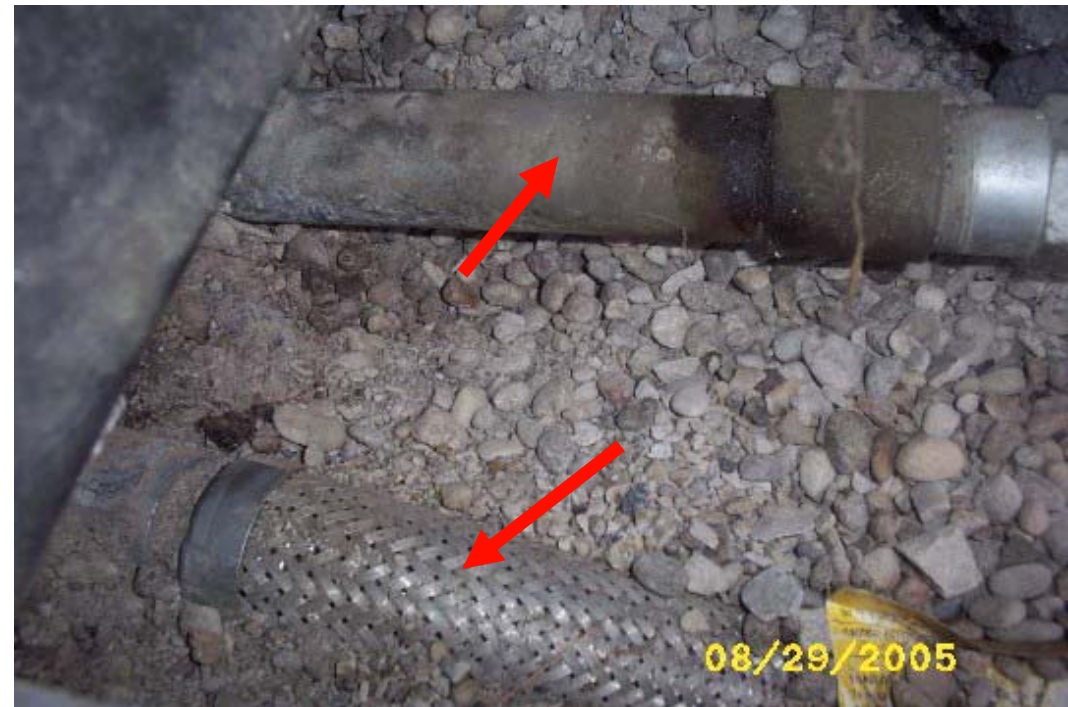

Gravel or soil must not be in contact with flex connector or metal piping

# Steel Flex Connectors

Install sacrificial anodes if  
Flex connectors can not be  
Isolated from water and/or soil

Bag Anode (top)  
Bare Anode  
(bottom)



# Steel Flex Connectors

## 3. Adding Anodes to a steel flex connector.



drive-in rod anode

# Testing Cathodic Protection

**Both** Galvanic and Impressed Current cathodic protection systems must be tested periodically (every 3 years) by a cathodic protection tester to ensure they are working properly.



# Testing Cathodic Protection

## For Cathodic Protection Systems:

- A test must be conducted within six months of installation and then at least every three years.
- Keep records of the last **two** cathodic protection tests.

# Testing Cathodic Protection

## For Impressed Current cathodic protection systems:

The **rectifier** must be inspected and recorded **at least every 60 days** to make sure it is on and operating properly.

- Keep records of the last **three** rectifier inspections using the Divisions Rectifier form.



# Walkthrough Form- CP Rectifier Log

EVENT	DATE	TAP SETTINGS		DC OUTPUT (as indicated on the rectifier meter)		DC OUTPUT (MEASURED using a voltmeter)		HOUR METER	COMMENTS
		COARSE	FINE	VOLTS	AMPS	VOLTS	AMPS		
"AS FOUND"									
"AS LEFT"									

Check all that apply:  single amp/voltmeter  dual amp/voltmeter  red/green indicator light

II. IMPRESSED CURRENT RECTIFIER INSPECTION (EVERY 60 DAYS) (If applicable this section can be used in lieu of the Division's 60-Day Record of Rectifier Operation form (form CN-1282))														
Any variance greater than 20% of an amperage from the last test should be investigated and necessary repairs/adjustments made. A corrosion expert's approval may be required.														
1. What is the "as left" measured rectifier output as indicated in Section X of the last Impressed Current Cathodic Protection Test Form?	VOLTS	AMPS	VOLTS	AMPS	VOLTS	AMPS	VOLTS	AMPS	VOLTS	AMPS	VOLTS	AMPS	VOLTS	AMPS
2. Current voltage and amperage readings:	VOLTS	AMPS	VOLTS	AMPS	VOLTS	AMPS	VOLTS	AMPS	VOLTS	AMPS	VOLTS	AMPS	VOLTS	AMPS
3. Hour meter reading (if present)	HOURS		HOURS		HOURS		HOURS		HOURS		HOURS		HOURS	
4. Rectifier Inspection Date (MM/DD/YY)														

Example: The 'as left' from the most recent three year cathodic protection system test is 2.0 amps, and the current sixty day reading is 1.75 amps.

$$2.0 \text{ amps} \times 0.20 (20\%) = +/-0.4 \text{ amps}$$

$$20\% \text{ range} = 1.6 \text{ amps to } 2.4 \text{ amps}$$

The 1.75 amp reading is within the acceptable 20% range

If the reading exceeds the 20% variance the system should be retested.

# What's Wrong With This?



# What's Wrong With This?



# What You Must Remember About Cathodic Protection

1. Cathodic protection systems must operate continuously and protect all metal tanks and piping in contact with the ground, standing water, or other liquids.
2. If CP system is **turned off or inoperable** for 12 months or more, tanks must be taken out of service and closed.



# What You Must Remember About Cathodic Protection

3. Cathodic protection systems must be tested:
  - a. every three years
  - b. keep records of the last **two** cathodic protection tests.
  - c. within 6 months of **installation**
  - d. within 6 months of any **repair**
  
4. **IC** Rectifiers must be checked every 60 days and maintain the last three inspections.

# Complete Cathodic Protection Poll

- Please complete polling questions on bottom right of screen.

# We Have Covered...

- ✓ **Tanks and Piping**
- ✓ **Spill Prevention**
- ✓ **Overfill Prevention**
- ✓ **Corrosion Protection**

**Next:**  
**Leak Detection**

# Available Leak Detection Methods

- Automatic Tank Gauging
- Statistical Inventory Reconciliation
- Interstitial Monitoring (*must be used on tanks or pressurized piping installed after 7/24/2007*)
- Manual Tank Gauging- Least Common Method



# What You Must Know About Leak Detection

- All tanks **installed after July 24, 2007** must be double-walled and use **interstitial monitoring** release detection.
- Leak Detection must be performed **every 30 days**.
- Leak detection records must be kept for **at least the last 12 consecutive months**.

# Automatic Tank Gauging (ATG)

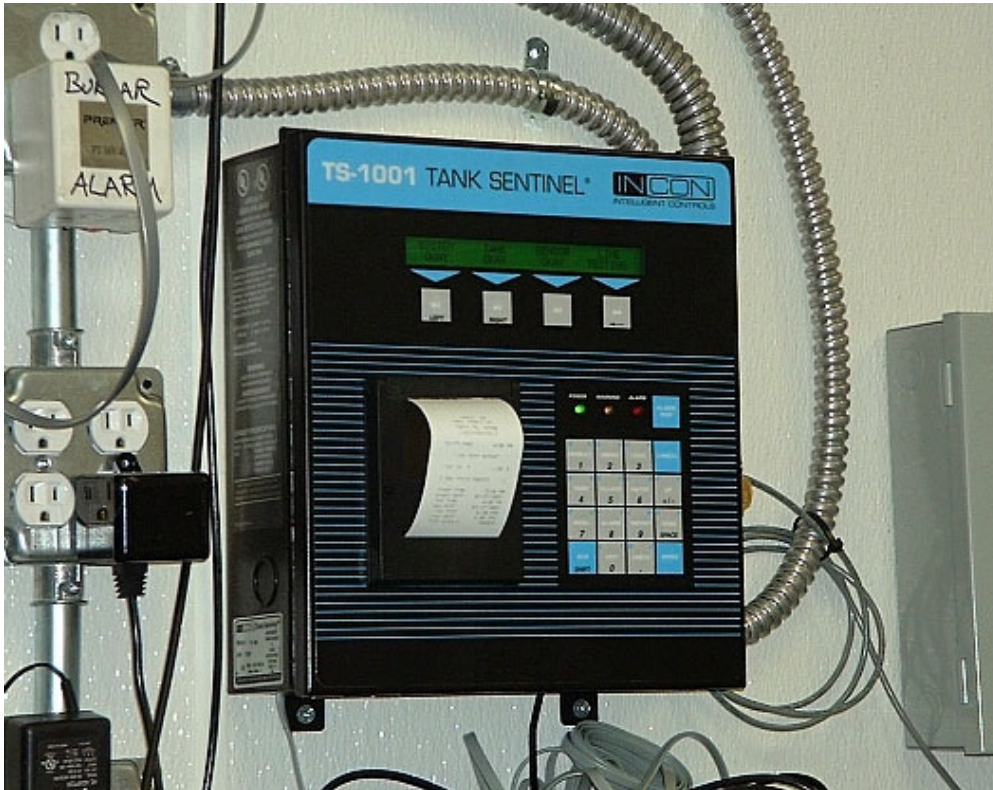

# Automatic Tank Gauging (ATG)

An ATG system consists of a **permanently installed probe** that collects information such as product level and temperature, and a **console** inside the facility which calculates changes in product volume that can indicate a leak. The console should signal an **alarm** when there is a suspected problem. An ATG must be able to detect a **0.2 gph leak**.

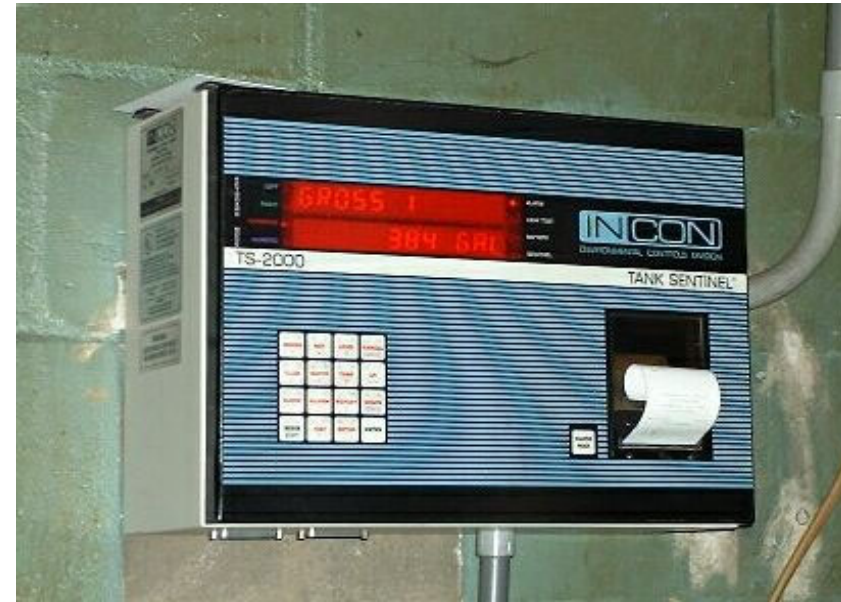

# How much is two tenths of a gallon?



# Monthly ATG Leak Detection

This is the size of **monthly** leak an ATG must be able to detect:



**Two tenths of a  
gallon  
0.2 gal.**

# Automatic Tank Gauge Components



**Probes**  
(inside the tank)



**Console**  
(inside the building)

# Automatic Tank Gauge Probe Locations

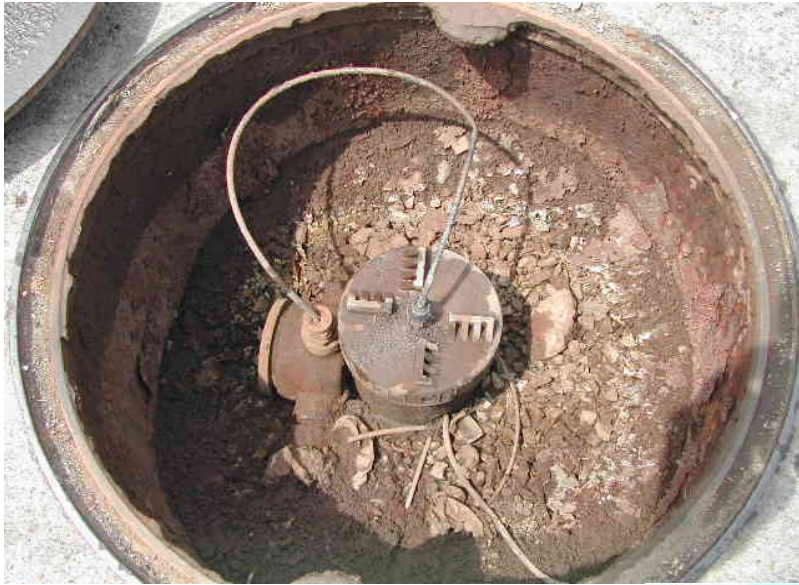

# What you should know about ATGs

## Testing Methods:

- **Static testing**- A test requiring a period of quiet time (no sales or deliveries) for a specific amount of time while the test is being performed.
- **Continuous testing**- A test method which allows tanks to remain in service while conducting testing. Data is gathered continuously resulting in a monthly test. (CSLD SCALD CITLDS)
- All ATGs require a certain minimum amount of product in the tank to conduct a valid test.

If a monthly 0.2 GPH test result is not available by the end of the month a static test should be conducted to produce a release detection record for the month.



# Never Ignore ATG Alarms



# Monthly Walkthrough Release Detection

5. Check release detection equipment to ensure it is operating with no alarms or other unusual operating conditions present.

6. Review and confirm release detection records are current.

7. Suspected release documented and reported to the Division\*

\*Suspected releases include, but are not limited to: failing release detection results (or 2 consecutive "inconclusive" SIR results), sensor alarms which are not immediately investigated, the presence of released petroleum at the UST site, unusual operating conditions such as erratic behavior of dispensing equipment, sudden loss of petroleum from the UST system, the unexplained presence of water in the tank, or liquids in the interstitial space of secondarily contained UST systems which returns after being removed. If you are unsure if a suspected release has occurred, consult the local TDEC field office for guidance.

Facility Name	<input type="text"/>	UST Facility ID	<input type="text"/>										YEAR	<input type="text"/>
Release Detection Method	ACTIVITY	JAN	FEB	MAR	APR	MAY	JUN	JUL	AUG	SEP	OCT	NOV	DEC	
<input type="checkbox"/> ATG Automatic Tank Gauge	1. Monthly leak test report is printed and stored with release detection records (Y/N)?	<input type="text"/>	<input type="text"/>	<input type="text"/>	<input type="text"/>	<input type="text"/>	<input type="text"/>	<input type="text"/>	<input type="text"/>	<input type="text"/>	<input type="text"/>	<input type="text"/>	<input type="text"/>	
	2. ATG console has active leak alarms (Y/N)?	<input type="text"/>	<input type="text"/>	<input type="text"/>	<input type="text"/>	<input type="text"/>	<input type="text"/>	<input type="text"/>	<input type="text"/>	<input type="text"/>	<input type="text"/>	<input type="text"/>	<input type="text"/>	

**\*Must include ATG result along with the walkthrough form.\***

# Release Detection Equipment Operability Testing

- Annual testing of **electronic** and **mechanical** release detection components
- **Tank Owner Responsibility:** Maintain the **three** previous annual tests of release detection components.
  - Automatic tank gauge and other controllers: test alarm; verify system configuration; test battery backup
  - Probes and sensors: inspect for residual buildup; ensure floats move freely; ensure shaft is not damaged; ensure cables are free of kinks and breaks; test alarm operability and communication with controller
  - Automatic line leak detector function test
  - Vacuum pumps and pressure gauges: ensure proper communication with sensors and controller
  - Test all IM tank and sump sensors

# Annual Testing- Electronic Devices (ATG and Interstitial Monitoring Console Testing)

- 1) Test alarm (audible/visual)
- 2) Verify system configuration (setup parameters)
- 3) Include setup parameters in test report
- 4) Test battery backup
- 5) Wires and cables- undamaged, properly connected
- 6) Document all necessary repairs
- 7) Maintain repair records for three (3) years



# Annual Testing- ATG Probe

- 1) Remove probe from tank
- 2) Verify probe floats move freely
- 3) Probe shaft and components are undamaged
- 4) Wires and cables- undamaged, properly connected
- 5) Document all necessary repairs



# Annual ATG Operability Test Form



STATE OF TENNESSEE  
 DEPARTMENT OF ENVIRONMENT AND CONSERVATION  
 DIVISION OF UNDERGROUND STORAGE TANKS  
 William R. Snodgrass Tennessee Tower  
 312 Rosa L. Parks Avenue, 12th Floor  
 Nashville, TN 37243-1541  
 (615) 532-0945

UST Facility ID #:

ANNUAL AUTOMATIC TANK GAUGE OPERABILITY TEST REPORT	
<p>➤ This form is developed in accordance with <b>Technical Chapter 3.2 AUTOMATIC TANK GAUGING, APPENDIX 2</b> "Automatic Tank Gauge Operability Test Procedure". Alternative forms may be submitted to the Division for prior approval.</p> <p>➤ This procedure is to determine if an Automatic Tank Gauge (ATG) is operating properly.</p>	
I. FACILITY	II. OWNER
UST Facility ID #:	Name/Company:
Facility Name:	Address:
Address:	City, State, Zip:
City:	County:
	Phone:
III. TESTER	
Name:	Company Address:
Company Name:	City, State, Zip:
Tester Certification Number:	Phone:
Tester Certification Date:	Email:
IV. ATG INFORMATION	
1. ATG manufacturer and model:	
2. Software version:	
3. Release detection method: (ATG-Continuous, ATG-Static, ATG-IM, ATG-CITLDS, ATG-SIR)	
4. Has the battery backup been tested and replaced if necessary?	YES <input type="checkbox"/> NO <input type="checkbox"/>
5. Are ATG console alarms functional and audible and/or visible to the facility operator?	YES <input type="checkbox"/> NO <input type="checkbox"/>
6. Is the ATG console on a dedicated electrical circuit?	YES <input type="checkbox"/> NO <input type="checkbox"/>
7. Are ATG Setup Reports printed and attached to this form?	YES <input type="checkbox"/> NO <input type="checkbox"/>
8. Is ATG programmed properly in accordance with manufacturer's instructions?	YES <input type="checkbox"/> NO <input type="checkbox"/>

V. TEST RESULTS						
All parameters must be answered for the test to be complete. Necessary repairs must be conducted immediately for the device to function properly. Documentation of necessary repairs must be attached to this form.						
Tank Number						
1. Product Stored:						
2. Probe serial number:						
3. Tank Volume (gallons):						
4. Tank Diameter (inches):						
5. ATG probes removed from tank, inspected for damage. Probe cap is secured and sealed:	YES <input type="checkbox"/> NO <input type="checkbox"/>	YES <input type="checkbox"/> NO <input type="checkbox"/>	YES <input type="checkbox"/> NO <input type="checkbox"/>	YES <input type="checkbox"/> NO <input type="checkbox"/>	YES <input type="checkbox"/> NO <input type="checkbox"/>	YES <input type="checkbox"/> NO <input type="checkbox"/>
6. ATG probe cables are free from kinks or breaks; seal packs, rubber grommets, and cap gaskets are in good condition:	YES <input type="checkbox"/> NO <input type="checkbox"/>	YES <input type="checkbox"/> NO <input type="checkbox"/>	YES <input type="checkbox"/> NO <input type="checkbox"/>	YES <input type="checkbox"/> NO <input type="checkbox"/>	YES <input type="checkbox"/> NO <input type="checkbox"/>	YES <input type="checkbox"/> NO <input type="checkbox"/>
7. Floats move freely and are free of corrosion or residue:	YES <input type="checkbox"/> NO <input type="checkbox"/>	YES <input type="checkbox"/> NO <input type="checkbox"/>	YES <input type="checkbox"/> NO <input type="checkbox"/>	YES <input type="checkbox"/> NO <input type="checkbox"/>	YES <input type="checkbox"/> NO <input type="checkbox"/>	YES <input type="checkbox"/> NO <input type="checkbox"/>
8. Gauged fuel height and ATG inventory height match:	YES <input type="checkbox"/> NO <input type="checkbox"/>	YES <input type="checkbox"/> NO <input type="checkbox"/>	YES <input type="checkbox"/> NO <input type="checkbox"/>	YES <input type="checkbox"/> NO <input type="checkbox"/>	YES <input type="checkbox"/> NO <input type="checkbox"/>	YES <input type="checkbox"/> NO <input type="checkbox"/>
9. Gauged water height and ATG inventory height match:	YES <input type="checkbox"/> NO <input type="checkbox"/>	YES <input type="checkbox"/> NO <input type="checkbox"/>	YES <input type="checkbox"/> NO <input type="checkbox"/>	YES <input type="checkbox"/> NO <input type="checkbox"/>	YES <input type="checkbox"/> NO <input type="checkbox"/>	YES <input type="checkbox"/> NO <input type="checkbox"/>
10. ATG alarm activates when fuel float is lowered to bottom of probe shaft:	YES <input type="checkbox"/> NO <input type="checkbox"/>	YES <input type="checkbox"/> NO <input type="checkbox"/>	YES <input type="checkbox"/> NO <input type="checkbox"/>	YES <input type="checkbox"/> NO <input type="checkbox"/>	YES <input type="checkbox"/> NO <input type="checkbox"/>	YES <input type="checkbox"/> NO <input type="checkbox"/>
11. ATG alarm activates at correct level when water float is raised from bottom of probe shaft:	YES <input type="checkbox"/> NO <input type="checkbox"/>	YES <input type="checkbox"/> NO <input type="checkbox"/>	YES <input type="checkbox"/> NO <input type="checkbox"/>	YES <input type="checkbox"/> NO <input type="checkbox"/>	YES <input type="checkbox"/> NO <input type="checkbox"/>	YES <input type="checkbox"/> NO <input type="checkbox"/>
12. ATG Operability Test Result (PASS/FAIL): (The ATG Operability Test fails if any of the YES/NO form questions are marked "NO".)						
Review active alarm and alarm history reports to verify no active or recurring leak detection warnings or alarms. Document potential issues in comments section below.						
Comments section:						
I certify under penalty of law that the tests were conducted according to the protocol of the test method used and was performed in accordance with all regulatory requirements set forth in 0400-18-01-.04(1)3 and that the submitted information is true, accurate and complete.						
Test Date:				Tester's Signature:		

CN-2624

2

RDA 2304

CN-2624

1

RDA 2304

# Automatic Tank Gauging

## What you must do:

- Conduct leak test **at least once per month for each tank** if it isn't done automatically.
- Print out and keep at least **one** passing monthly leak test result for each tank from the ATG. ***It is best if this is done monthly.***
- Check for alarms or unusual operation conditions each month
- Review monthly release detection and record on walkthrough form
- Report all suspected releases within 72 hours.
- Keep the last 12 consecutive months of leak detection results.
- It is not a recommended practice to rely on the ATG memory to store leak detection records. Why?
- Perform ATG operability test annually. Maintain the last three years of ATG operability tests.

# Complete ATG Poll

- Please complete polling questions on bottom right of screen.



# Interstitial Monitoring

**Interstitial monitoring** checks the space between tank walls and/or piping walls for a release.

- The outer wall is the “**secondary containment**”
- The space between the inner and outer wall is called the **interstitial space** or **interstice**
- The interstitial space or interstice must be monitored **continuously**

# Interstitial Monitoring

## There are several ways:

- **Electronic sensors** - placed in interstice to send a signal when liquid is detected.
- **Hydrostatic Methods** - use liquid-filled interstice with a reservoir where the liquid level is monitored.
- **Pressure/Vacuum Methods** - apply pressure or vacuum to interstice and monitor changes in pressure or vacuum.

Sensors are the most common and least expensive way to conduct interstitial monitoring.



# Double Wall Tanks

- All tanks installed after July 24, 2007, must be double-walled or jacketed, and use **interstitial monitoring**.

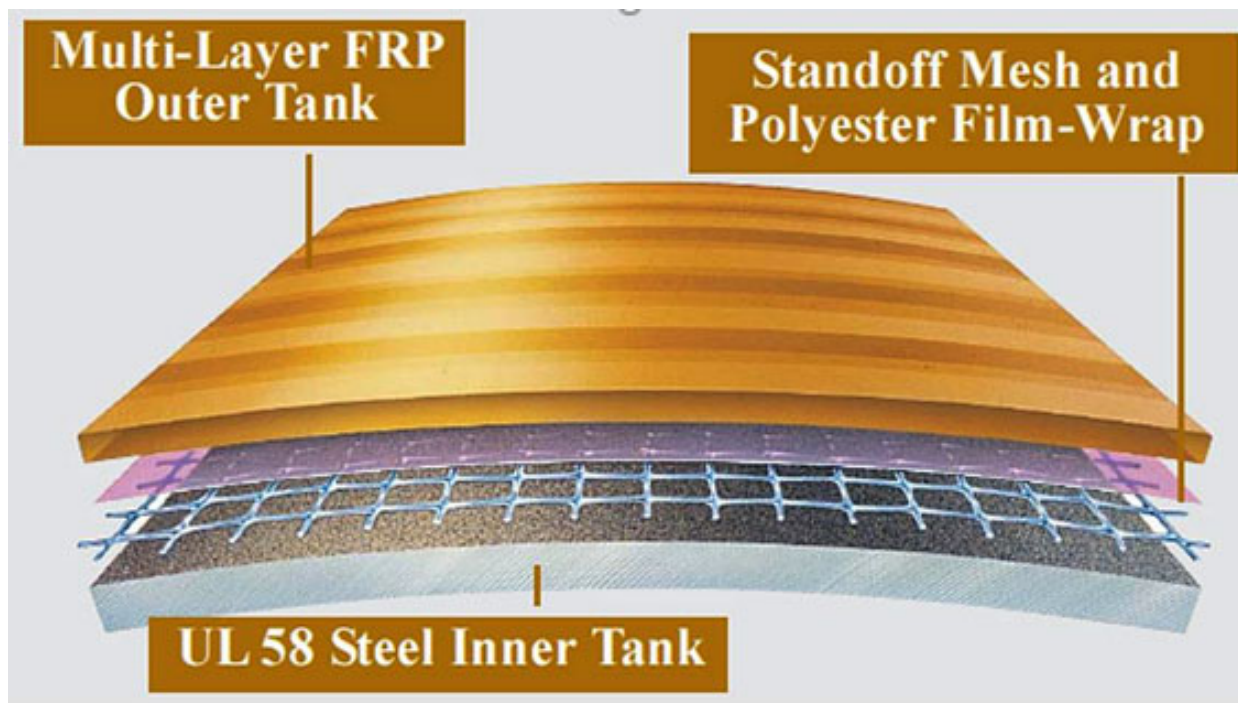

A tank with two shells (a tank within a tank)

# Hydrostatic monitoring in double wall tanks

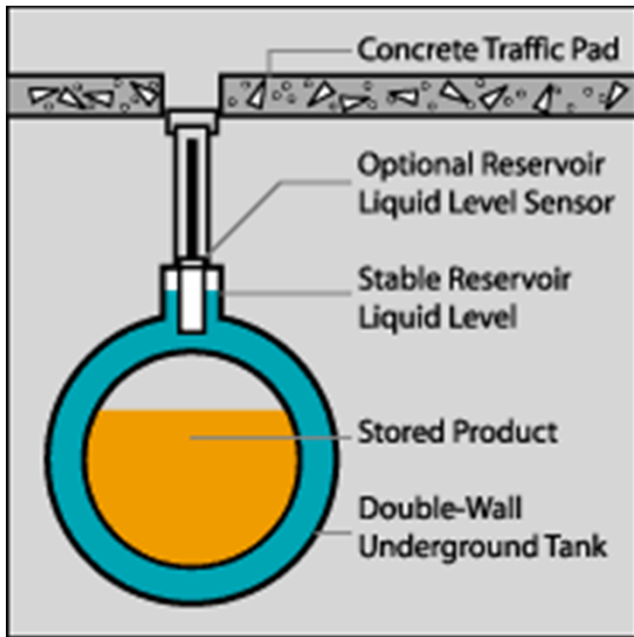

Normal leak sensing position

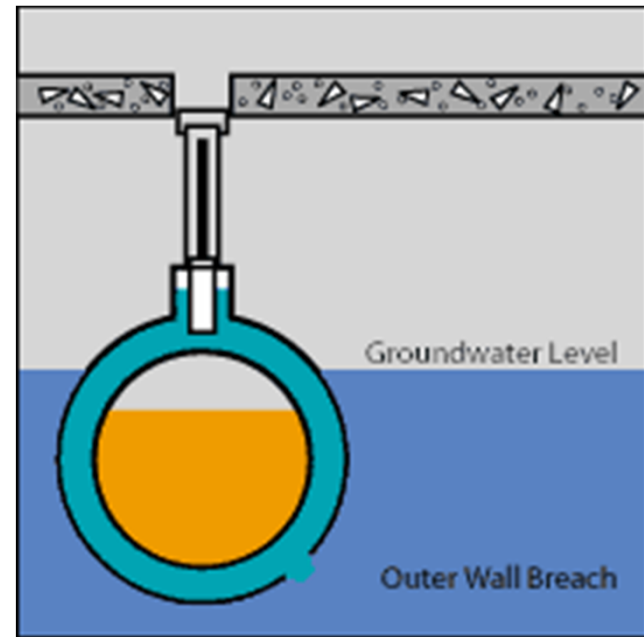

Leak in secondary wall

# Hydrostatic monitoring in double wall tanks

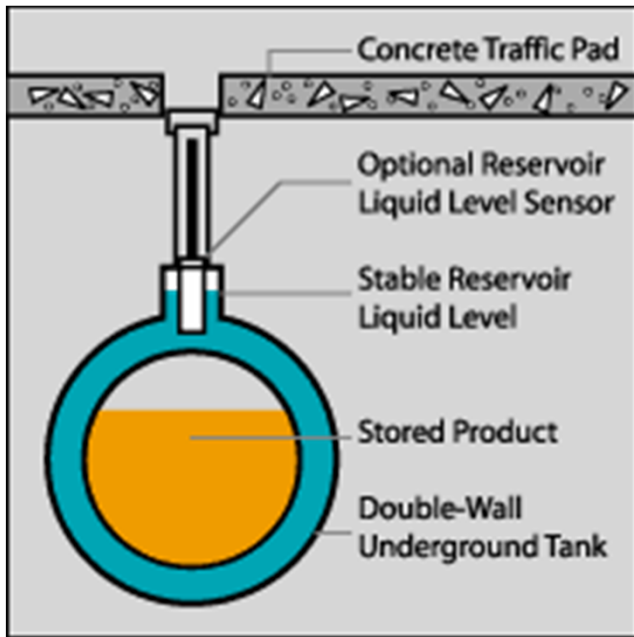

Normal leak sensing position

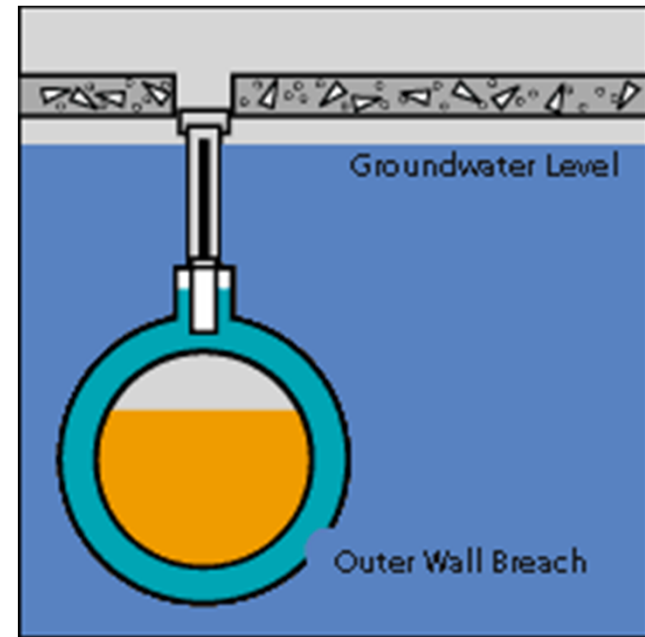

Leak in secondary wall  
high ground water

# Sensor use in double wall FRP Tanks



Sensor for fiberglass tanks

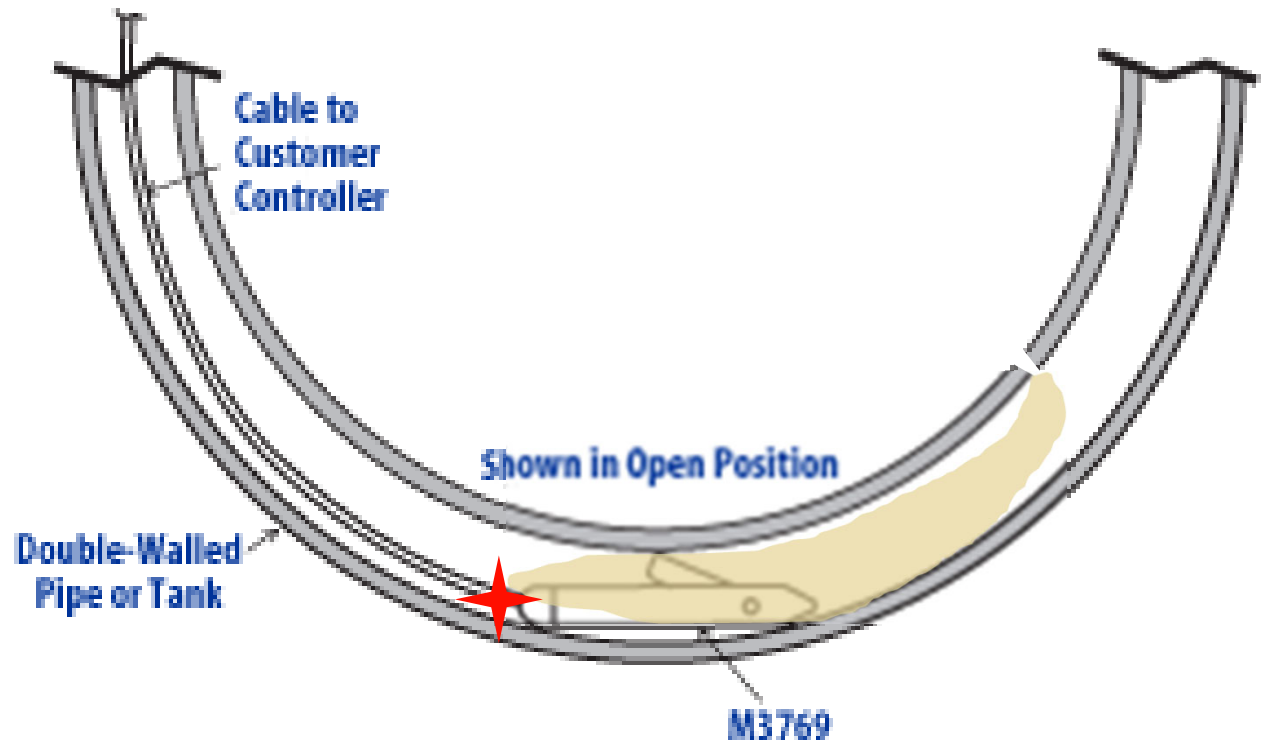

If a sensor detects petroleum **between the walls of a double wall tank**, it is treated as **a suspected release.**

# Sensor Status and Alarm History Reports

INCON  
INTELLIGENT CONTROLS INC  
P. O. BOX 638  
SACO ME 04072  
1-800-984-6266

08/01/1998 12:16 PM

## SENSOR STATUS REPORT

SENSOR NO. 1  
SENSOR 1  
OK

SENSOR NO. 2  
SENSOR 2  
OK

SENSOR NO. 3  
SENSOR 3  
OK

SENSOR NO. 4  
SENSOR 4  
OK

SENSOR NO. 5  
SENSOR 5  
OK

SENSOR NO. 6  
SENSOR 6  
OK

SENSOR NO. 7  
SENSOR 7  
STANDARD SENSOR ACTIVE

SENSOR NO. 8  
SENSOR 8  
LOW BRINE LEVEL ACTIVE

INCON TS-1001 Sensor  
Status Report

AUG 30, 2010 13:13  
LIQUID STATUS  
-----  
AUG 30, 2010 13:13

L 1:DISP 1-2  
SENSOR NORMAL

L 2:DISP 3-4  
SENSOR NORMAL

L 3:DISP 5-6  
SENSOR NORMAL

L 4:DISP 7-8  
SENSOR NORMAL

L 5:DISP 9-10  
SENSOR NORMAL

L 6:DISP 11-12  
SENSOR NORMAL

L 7:DISP 13-14  
SENSOR NORMAL

L 8:DISP 15-16  
SENSOR NORMAL

L 9:PREM INTERSTITIAL  
SENSOR NORMAL

L11:UNLEAD ANNULAP  
SENSOR NORMAL

L12:DIESEL STP SUMP  
SENSOR NORMAL

L13:PREM STP SUMP  
SENSOR NORMAL

L14:UNLD STP SUMP  
SENSOR NORMAL

\*\*\*\*\* END \*\*\*\*\*

Veeder Root TLS-350 Liquid  
Status Report

## ALARM HISTORY REPORT

----- SENSOR ALARM -----

L 2:PREM STP SUMP  
STP SUMP  
FUEL ALARM  
JUL 20, 2017 10:01 AM

FUEL ALARM  
JUL 3, 2017 3:43 PM

SENSOR OUT ALARM  
MAY 3, 2017 2:25 PM

\*\*\*\*\* END \*\*\*\*\*

INCON  
INTELLIGENT CONTROLS INC  
P. O. BOX 638  
SACO ME 04072  
1-800-984-6266

01/04/1999 2:22 PM

## SENSOR ALARMS

01/04/1999 2:20 PM  
HIGH BRINE LEVEL  
SENSOR 16  
SENSOR NO. 16

01/04/1999 2:20 PM  
DRY WELL  
SENSOR 12  
SENSOR NO. 12

01/04/1999 2:20 PM  
HIGH BRINE LEVEL  
SENSOR 8  
SENSOR NO. 8

01/04/1999 2:19 PM  
STANDARD SENSOR  
SENSOR 15  
SENSOR NO. 15

01/04/1999 2:19 PM  
STANDARD SENSOR  
SENSOR 7  
SENSOR NO. 7

01/04/1999 2:12 PM  
DRY WELL  
SENSOR 4  
SENSOR NO. 4

INCON TS-1001 Sensor Alarm  
History

# Monthly Walkthrough IM

5. Check release detection equipment to ensure it is operating with no alarms or other unusual operating conditions present.												
6. Review and confirm release detection records are current.												
7. Suspected release documented and reported to the Division*												
<p>*Suspected releases include, but are not limited to: failing release detection results (or 2 consecutive "inconclusive" SIR results), sensor alarms which are not immediately investigated, the presence of released petroleum at the UST site, unusual operating conditions such as erratic behavior of dispensing equipment, sudden loss of petroleum from the UST system, the unexplained presence of water in the tank, or liquids in the interstitial space of secondarily contained UST systems which returns after being removed. If you are unsure if a suspected release has occurred, consult the local TDEC field office for guidance.</p>												

<div style="border: 1px solid black; padding: 5px; width: 40px; height: 40px; display: flex; align-items: center; justify-content: center;">IM</div> <small>Interstitial Monitoring</small>	1. Maintain monthly sensor status and alarm history reports (Y/N)? Standalone Monthly Electronic Interstitial Alarm Report form no longer required.											
	2. Document the date, location, cause, and action taken to investigate/resolve each alarm and suspected release in COMMENTS / ACTIONS TAKEN section on page 4 of this form (Y/N)?											

DATE	ACTION TAKEN

**Must include monthly status and alarm history with walkthrough form**



# Annual IM Testing Form



STATE OF TENNESSEE  
 DEPARTMENT OF ENVIRONMENT AND CONSERVATION  
 DIVISION OF UNDERGROUND STORAGE TANKS  
 William R. Snodgrass Tennessee Tower  
 312 Rosa L. Parks Avenue, 12<sup>th</sup> Floor  
 Nashville, Tennessee 37243

ANNUAL ELECTRONIC INTERSTITIAL MONITORING TEST REPORT									
This report is used to document functional testing of electronic interstitial monitoring devices. <ul style="list-style-type: none"> <li>➤ In the absence of an approved 3<sup>rd</sup> party test procedure or manufacturer's recommended practice, the procedure outlined below may be used to verify the interstitial monitoring devices are working properly.</li> <li>➤ Interstitial monitoring is required on all UST systems installed after July 24, 2007.</li> <li>➤ Report any unusual operating conditions or suspected releases discovered during this test to the division within 72 hours of discovery. Failure to do so could affect fund coverage in the event of a release.</li> <li>➤ Attach documentation of all completed repairs, service invoices, or leak detection equipment replacement to this report, and maintain these records for a period of 12 months.</li> </ul>									
I. UST FACILITY					II. PERSON CONDUCTING TEST				
UST Facility ID #:					Name:				
Facility Name:					Company:				
Address:					City:			State	
City:			County:		ZIP:		Phone:		
Tester Signature:					Test Date:				
III. TEST AND MONITORING DEVICE INFORMATION (Attach additional pages as necessary)									
Sensor ID									
Manufacturer									
Model #									
Location:									
Type of Sensor(s) (Check all that apply)	<input type="checkbox"/> Float Switch- Type:	<input type="checkbox"/> discriminating			<input type="checkbox"/> non-discriminating				
	<input type="checkbox"/> Optical Sensor	<input type="checkbox"/> Electrical Conductivity Sensor			<input type="checkbox"/> Pressure Monitoring Device				
	<input type="checkbox"/> Vacuum Monitoring Device	<input type="checkbox"/> Other (specify):							
System Setup (Check all that apply)	If a sensor is activated, the interstitial monitoring system responds with the following actions:								
	<input type="checkbox"/> Visual Alarm	<input type="checkbox"/> Audible Alarm			<input type="checkbox"/> Tank Monitor Leak Alarm				
	<input type="checkbox"/> Submersible Pump Shutdown	<input type="checkbox"/> Off Site Telemetry Alarm			<input type="checkbox"/> Other (specify)				
IV. ELECTRONIC INTERSTITIAL MONITORING TEST PROCEDURE									
Check Completed	Task								

# Interstitial Monitoring

## What you must do:

- Complete monthly IM form and attach sensor status and alarm history reports every 30 days.
- Keep the last 12 consecutive months of leak detection results.
- Investigate all alarms within 72 hours and document actions taken
- Report all suspected releases within 72 hours.
- Conduct annual sensor and ATG operability testing. Maintain the previous 3 years of annual ATG and sensor testing results.

# Statistical Inventory Reconciliation (SIR)

**SIR** uses a computer program to perform *statistical analysis* of inventory, delivery and dispensing data every 30 days. A gauging stick or ATG is used to gather inventory data.

**SIR** requires the tank owner to follow specific data collection procedures.

- **Daily 1/8 in. fuel measurements**
- **1/8 in. fuel measurements before & after every delivery**
- **Daily Sales in gallons**
- **Monthly water readings**
- **Annual meter calibration**
- **Deliveries through drop tubes**

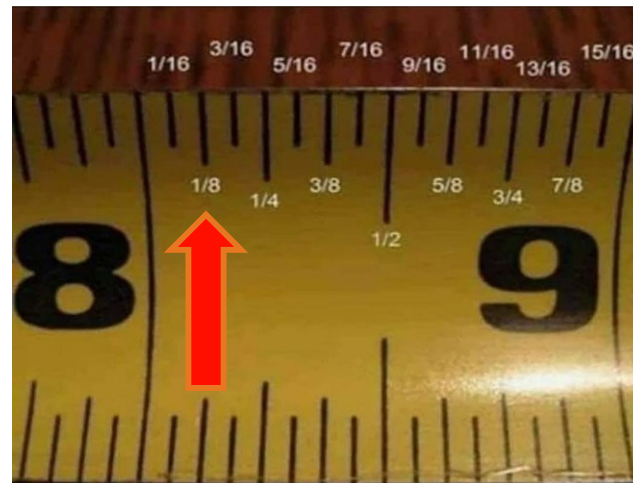

# Statistical Inventory Reconciliation (SIR)

- SIR may be conducted by a **SIR vendor** for the tank owner, or by a tank owner using an acceptable SIR program.
- SIR results must be reported as ***PASS, FAIL, or INCONCLUSIVE.***
- SIR results apply only for monthly leak detection for tanks and piping.

# Statistical Inventory Reconciliation (SIR)

- Inventory data is sent to a **SIR vendor** (or entered into a computer program leased to the tank owner by the SIR vendor) at least once every 30 days.
- A report must be reported monthly after the end of the data collection for that time period.
- You must keep **complete** SIR records:
  - Daily product levels
  - Deliveries and sales as determined by direct measurements
  - Daily reconciliation of measured amounts in the tank compared to calculated amounts in the tank
  - Statistical Inventory Reconciliation (Monthly report from Provider)

# SIR Inconclusive Results

- A SIR **inconclusive** result means you do **not** have a passing leak detection result for the month.
- The problem might be poor measurements, miscalibrated meters, missed deliveries, or something else. Contact your SIR vendor for help.
- If an **inconclusive** monthly result is received, you must **investigate immediately** and correct any problem.
- Document results of the investigation and keep with leak detection records.

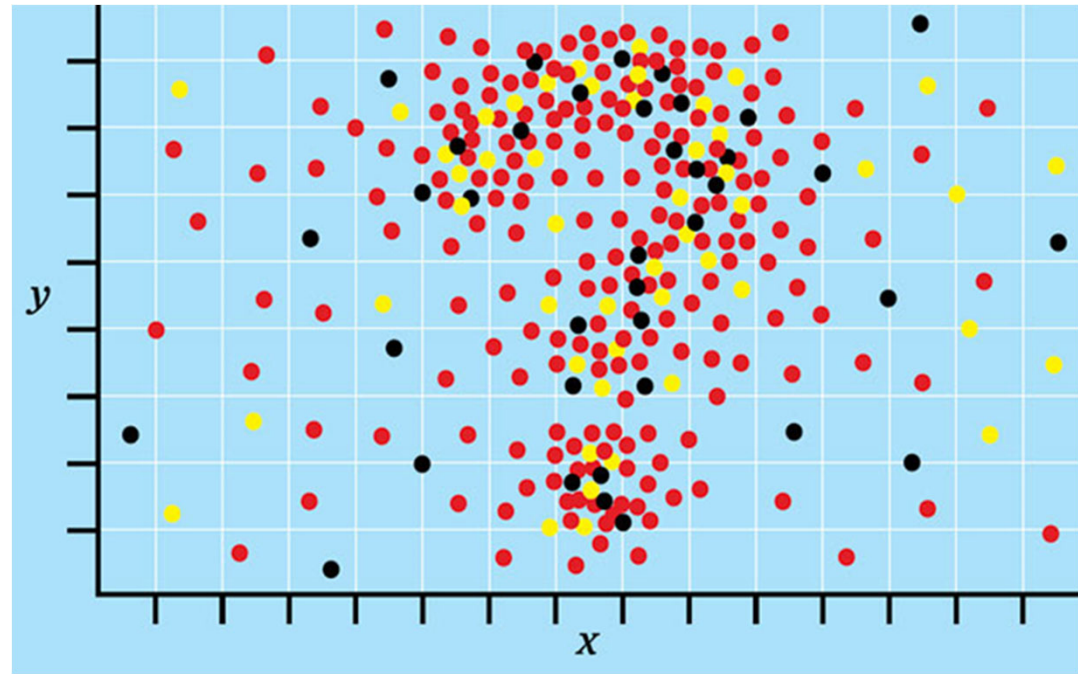

# SIR Inconclusive Results

- If you receive **inconclusive** results for **2 consecutive months**, it is a suspected release, and this must be reported to the Division within 72 hours.
- Report **all FAIL** SIR results as a suspected release to the Division within 72 hours.
- Follow instructions given by the Division after reporting 2 consecutive monthly inconclusive or one Fail SIR result.

# Statistical Inventory Reconciliation (SIR)

## What you must have:

- A contract with a SIR provider to analyze monthly leak detection records, or a SIR program to conduct SIR analysis.
- A means to collect product inventory data (gauging stick, or ATG) on a daily basis.
- A means to convert measurements to gallons (tank chart).
- All meters calibrated annually

Be sure your measuring equipment is in good shape – not like this worn out stick





# SIR What you must do

- Collect and record inventory data every 30 days.
- Have records analyzed **every 30 days** by a SIR provider or a SIR computer program.
- Investigate and **correct** the causes for any **inconclusive** results.
- Keep the last 12 consecutive months of leak detection results.
- Record results on monthly walkthrough form.
- Record hand-held equipment (gauging stick) inspection on the annual walkthrough form.
- Report all suspected releases within 72 hours. (any **FAIL**, or any two consecutive **INCONCLUSIVE** results)

 SIR Statistical Inventory Reconciliation	1. Current monthly SIR report reviewed (Y/N)?	<input type="checkbox"/>	<input type="checkbox"/>	<input type="checkbox"/>	<input type="checkbox"/>	<input type="checkbox"/>	<input type="checkbox"/>	<input type="checkbox"/>	<input type="checkbox"/>	<input type="checkbox"/>	<input type="checkbox"/>	<input type="checkbox"/>	<input type="checkbox"/>
	2. Drop tube is present (Y/N)?	<input type="checkbox"/>	<input type="checkbox"/>	<input type="checkbox"/>	<input type="checkbox"/>	<input type="checkbox"/>	<input type="checkbox"/>	<input type="checkbox"/>	<input type="checkbox"/>	<input type="checkbox"/>	<input type="checkbox"/>	<input type="checkbox"/>	<input type="checkbox"/>
	3. Water level reading recorded (Y/N)?	<input type="checkbox"/>	<input type="checkbox"/>	<input type="checkbox"/>	<input type="checkbox"/>	<input type="checkbox"/>	<input type="checkbox"/>	<input type="checkbox"/>	<input type="checkbox"/>	<input type="checkbox"/>	<input type="checkbox"/>	<input type="checkbox"/>	<input type="checkbox"/>
	4. Inventory records used (raw data) included with monthly report (Y/N)?	<input type="checkbox"/>	<input type="checkbox"/>	<input type="checkbox"/>	<input type="checkbox"/>	<input type="checkbox"/>	<input type="checkbox"/>	<input type="checkbox"/>	<input type="checkbox"/>	<input type="checkbox"/>	<input type="checkbox"/>	<input type="checkbox"/>	<input type="checkbox"/>

# Complete SIR Poll

- Please complete polling questions on bottom right of screen.

# We Have Covered...

- ✓ **Tanks and Piping**
- ✓ **Spill Prevention**
- ✓ **Overfill Prevention**
- ✓ **Corrosion Protection**
- ✓ **Tank Leak Detection**

**Next:**

**Piping Leak Detection**

# Piping Leak Detection

Two types of piping systems:

- **Pressurized**- pump located at tank and pushes fuel under pressure to dispensers.
- **Suction**- Pump located and dispenser and pulls fuel up from the tank.

# Pressurized Piping Sump

- Uses a **submersible turbine pump** (STP) located inside the tank that pushes product to the dispenser.
- A pressurized piping system should have a STP head in a sump above the tank.
- These sumps are covered with a lid and may also have a sump cover under the lid.



# Submersible Turbine (STP) Heads

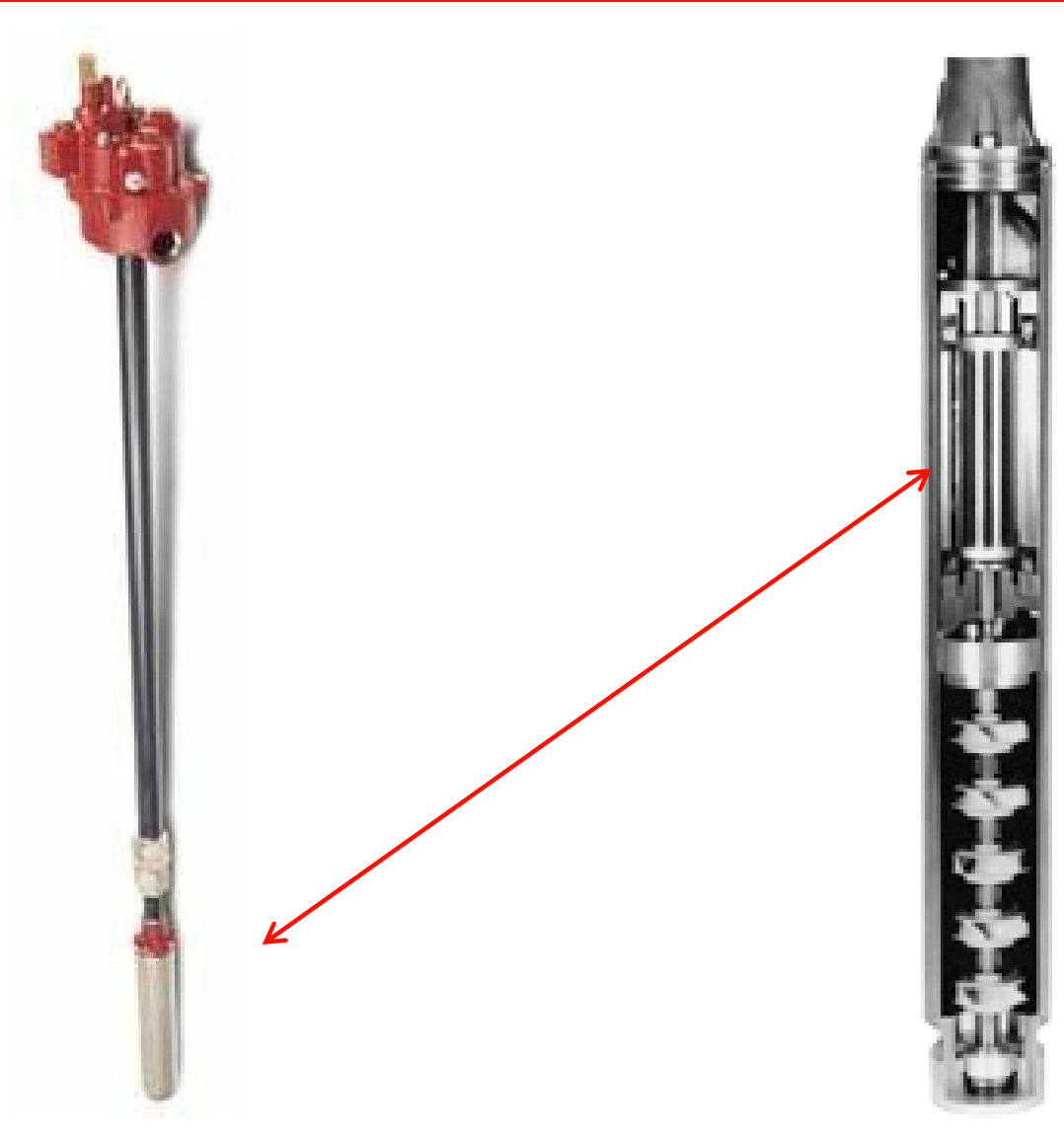

# Pressurized Piping Requirements

Pressurized piping **must** have **two** forms of Leak Detection:

1. **Catastrophic** -to detect large sudden releases, such as a piping failure. (3.0 GPH leak rate)
2. **Periodic** - to detect smaller, less noticeable releases

Let's look at each kind....

# Automatic Line Leak Detectors

***Catastrophic line leak detection*** is done by Automatic Line Leak Detectors (ALLDs or ELLDs).

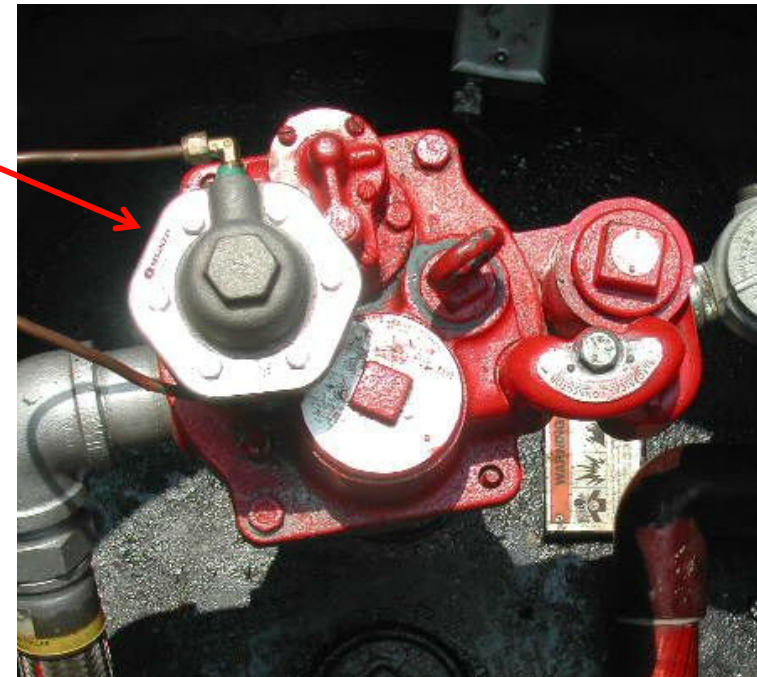
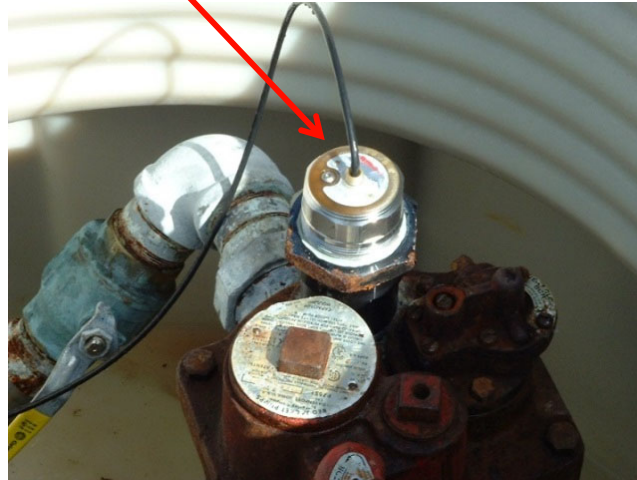



# Automatic Line Leak Detectors

ALLDs are located on the submersible turbine pump (STP) head in the sump above the tank.

There are two types of ALLDs:

1. **Mechanical** - pressure valves that test for piping leaks each time someone tries to pump fuel. **Only detects 3.0 gph leaks (Catastrophic)**



# Automatic Line Leak Detectors

and

- 2. Electronic** - electronic pressure sensors that communicate with an ATG control panel. Can detect 3.0 gph (catastrophic) and (periodic)- 0.2 gph monthly or 0.1 gph annually

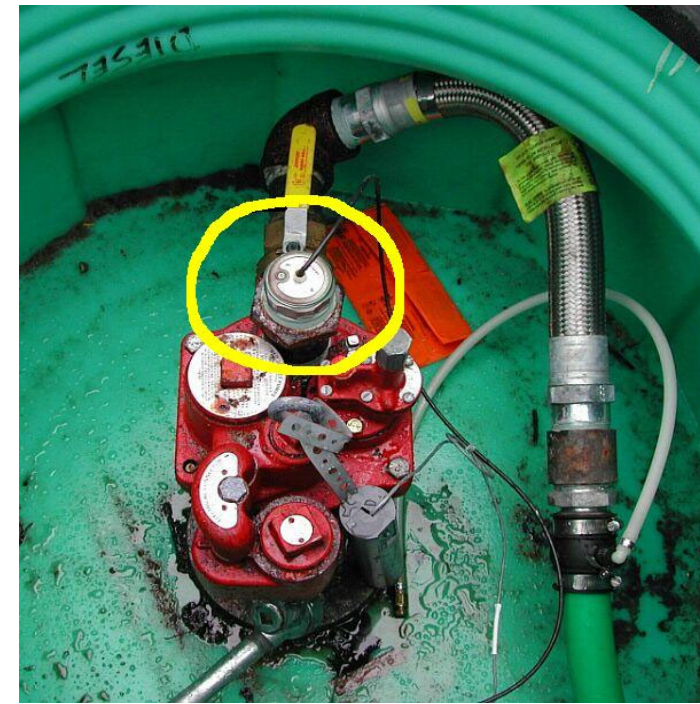
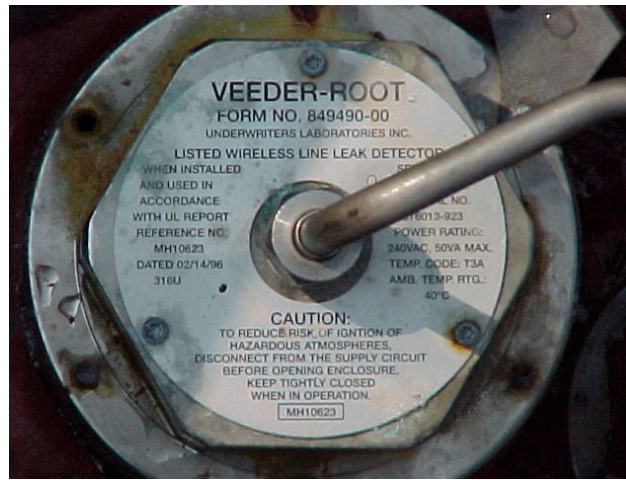

# Automatic Line Leak Detector Requirements

- **All leak detectors** (mechanical and electronic) must be tested at least every 12 months.
- Annual leak detector test results must be kept for three years.
- All leak detectors must perform according to manufacturer's specifications; if they cannot detect a leak of at least 3.0 gph @ 10 psi they must be replaced or adjusted to detect 3.0 gph @ 10 psi.

# ELLDs with Pressurized Piping

## Electronic Line Leak Detectors (ELLDs)

- They are designed to detect a 3.0 gph catastrophic leak, as well as perform periodic 0.2 gph and 0.1 gph periodic line tests when programmed correctly.
- Communicate with an ATG console at the facility.
- ELLDs may be programmed to shut down the submersible pump or activate an alarm whenever catastrophic line leaks are detected.
  - \*STP shutdown is required at unattended facilities.

# Annual Line Testing for Pressurized Piping

- A form of periodic piping leak detection
- Uses pressure to determine if the line is leaking
- Must be performed annually by a certified line tester
- This test method will require lines taken out of services during line testing



# Interstitial Monitoring using Secondary Containment

- Form of periodic piping leak detection
- All **pressurized piping** installed after July 24, 2007, must be double-walled or secondarily contained and use **interstitial monitoring**.
- Must be used in conjunction with an ALLD.
- Sumps must be continuously monitored, and sensors installed in every sump where product can leak and accumulate.
- Interstitial monitoring is **not required** for **safe suction** piping.

# Views of Sump Sensors



Tank-top sump sensor with secondarily contained piping

# Double Wall Piping Secondarily Contained Piping



Double wall piping  
with test boots



Double Wall Piping



Chase Piping



# Interstitial Monitoring

## What you must know:

- Sump Sensors may sound false alarms from water in sumps.
- Disabling or tampering with a sensor is a *criminal offense*.
- Moving a sensor out of position to detect liquid is a violation.
- Sensors can malfunction; therefore, you must conduct testing of sensors annually to ensure proper function.

# IM Sump Integrity Test

- Systems using (interstitial monitoring (IM) for piping release detection must conduct a sump integrity test every three years.
- Sump integrity test records must be maintained for three years.

# Tank, Piping and Containment Sump Repair

- All tank, piping or containment sump repairs (if used for IM) must be integrity tested within 30 days of completion of repair
- Tests conducted in accordance with:
  - 1) Manufacturer's instructions
  - 2) Division guidance
- Maintain test records for 3 years
- Maintain repair records for operational life of the UST system

# What's Wrong in This Picture?



# Sensor Status and Alarm History Reports

INCON  
INTELLIGENT CONTROLS INC  
P. O. BOX 638  
SACO ME 04072  
1-800-984-6266

08/01/1998 12:16 PM

## SENSOR STATUS REPORT

SENSOR NO. 1  
SENSOR 1  
OK

SENSOR NO. 2  
SENSOR 2  
OK

SENSOR NO. 3  
SENSOR 3  
OK

SENSOR NO. 4  
SENSOR 4  
OK

SENSOR NO. 5  
SENSOR 5  
OK

SENSOR NO. 6  
SENSOR 6  
OK

SENSOR NO. 7  
SENSOR 7  
STANDARD SENSOR ACTIVE

SENSOR NO. 8  
SENSOR 8  
LOW BRINE LEVEL ACTIVE

INCON TS-1001 Sensor  
Status Report

AUG 30, 2010 13:13  
LIQUID STATUS  
-----  
AUG 30, 2010 13:13

L 1:DISP 1-2  
SENSOR NORMAL

L 2:DISP 3-4  
SENSOR NORMAL

L 3:DISP 5-6  
SENSOR NORMAL

L 4:DISP 7-8  
SENSOR NORMAL

L 5:DISP 9-10  
SENSOR NORMAL

L 6:DISP 11-12  
SENSOR NORMAL

L 7:DISP 13-14  
SENSOR NORMAL

L 8:DISP 15-16  
SENSOR NORMAL

L 9:PREM INTERSTITIAL  
SENSOR NORMAL

L11:UNLEAD ANNULAP  
SENSOR NORMAL

L12:DIESEL STP SUMP  
SENSOR NORMAL

L13:PREM STP SUMP  
SENSOR NORMAL

L14:UNLD STP SUMP  
SENSOR NORMAL

\*\*\*\*\* END \*\*\*\*\*

Veeder Root TLS-350 Liquid  
Status Report

## ALARM HISTORY REPORT

----- SENSOR ALARM -----

L 2:PREM STP SUMP  
STP SUMP  
FUEL ALARM  
JUL 20, 2017 10:01 AM

FUEL ALARM  
JUL 3, 2017 3:43 PM

SENSOR OUT ALARM  
MAY 3, 2017 2:25 PM

\*\*\*\*\* END \*\*\*\*\*

INCON  
INTELLIGENT CONTROLS INC  
P. O. BOX 638  
SACO ME 04072  
1-800-984-6266

01/04/1999 2:22 PM

## SENSOR ALARMS

01/04/1999 2:20 PM  
HIGH BRINE LEVEL  
SENSOR 16  
SENSOR NO. 16

01/04/1999 2:20 PM  
DRY WELL  
SENSOR 12  
SENSOR NO. 12

01/04/1999 2:20 PM  
HIGH BRINE LEVEL  
SENSOR 8  
SENSOR NO. 8

01/04/1999 2:19 PM  
STANDARD SENSOR  
SENSOR 15  
SENSOR NO. 15

01/04/1999 2:19 PM  
STANDARD SENSOR  
SENSOR 7  
SENSOR NO. 7

01/04/1999 2:12 PM  
DRY WELL  
SENSOR 4  
SENSOR NO. 4

INCON TS-1001 Sensor Alarm  
History

# Monthly Walkthrough IM

5. Check release detection equipment to ensure it is operating with no alarms or other unusual operating conditions present.												
6. Review and confirm release detection records are current.												
7. Suspected release documented and reported to the Division*												
<p>*Suspected releases include, but are not limited to: failing release detection results (or 2 consecutive "inconclusive" SIR results), sensor alarms which are not immediately investigated, the presence of released petroleum at the UST site, unusual operating conditions such as erratic behavior of dispensing equipment, sudden loss of petroleum from the UST system, the unexplained presence of water in the tank, or liquids in the interstitial space of secondarily contained UST systems which returns after being removed. If you are unsure if a suspected release has occurred, consult the local TDEC field office for guidance.</p>												

<div style="border: 1px solid black; padding: 5px; width: 30px; height: 30px; display: flex; align-items: center; justify-content: center;">IM</div> <small>Interstitial Monitoring</small>	1. Maintain monthly sensor status and alarm history reports (Y/N)? Standalone Monthly Electronic Interstitial Alarm Report form no longer required.											
	2. Document the date, location, cause, and action taken to investigate/resolve each alarm and suspected release in COMMENTS / ACTIONS TAKEN section on page 4 of this form (Y/N)?											

DATE	ACTION TAKEN

**Must include monthly status and alarm history with walkthrough form**

# Annual IM Testing Form



STATE OF TENNESSEE  
 DEPARTMENT OF ENVIRONMENT AND CONSERVATION  
 DIVISION OF UNDERGROUND STORAGE TANKS  
 William R. Snodgrass Tennessee Tower  
 312 Rosa L. Parks Avenue, 12<sup>th</sup> Floor  
 Nashville, Tennessee 37243

ANNUAL ELECTRONIC INTERSTITIAL MONITORING TEST REPORT									
This report is used to document functional testing of electronic interstitial monitoring devices. <ul style="list-style-type: none"> <li>➤ In the absence of an approved 3<sup>rd</sup> party test procedure or manufacturer's recommended practice, the procedure outlined below may be used to verify the interstitial monitoring devices are working properly.</li> <li>➤ Interstitial monitoring is required on all UST systems installed after July 24, 2007.</li> <li>➤ Report any unusual operating conditions or suspected releases discovered during this test to the division within 72 hours of discovery. Failure to do so could affect fund coverage in the event of a release.</li> <li>➤ Attach documentation of all completed repairs, service invoices, or leak detection equipment replacement to this report, and maintain these records for a period of 12 months.</li> </ul>									
I. UST FACILITY					II. PERSON CONDUCTING TEST				
UST Facility ID #:					Name:				
Facility Name:					Company:				
Address:					City:			State	
City:			County:		ZIP:		Phone:		
Tester Signature:					Test Date:				
III. TEST AND MONITORING DEVICE INFORMATION (Attach additional pages as necessary)									
Sensor ID									
Manufacturer									
Model #									
Location:									
Type of Sensor(s) (Check all that apply)	<input type="checkbox"/> Float Switch- Type:	<input type="checkbox"/> discriminating			<input type="checkbox"/> non-discriminating				
	<input type="checkbox"/> Optical Sensor	<input type="checkbox"/> Electrical Conductivity Sensor			<input type="checkbox"/> Pressure Monitoring Device				
	<input type="checkbox"/> Vacuum Monitoring Device	<input type="checkbox"/> Other (specify):							
System Setup (Check all that apply)	If a sensor is activated, the interstitial monitoring system responds with the following actions:								
	<input type="checkbox"/> Visual Alarm	<input type="checkbox"/> Audible Alarm			<input type="checkbox"/> Tank Monitor Leak Alarm				
	<input type="checkbox"/> Submersible Pump Shutdown	<input type="checkbox"/> Off Site Telemetry Alarm			<input type="checkbox"/> Other (specify)				
IV. ELECTRONIC INTERSTITIAL MONITORING TEST PROCEDURE									
Check Completed	Task								

# Interstitial Monitoring

## What you must do:

- Complete monthly walkthrough form and attach sensor status and alarm history reports every 30 days.
- Keep the last 12 consecutive months of leak detection results.
- Investigate all alarms within 72 hours and document actions taken
- Report all suspected releases within 72 hours.
- Conduct annual sensor and ATG operability test.
- Maintain the previous 3 years of sensor and ATG operability tests.



# SIR for piping Release Detection

- Form of periodic piping release detection
- Since measurements are taken when fuel is first placed in the tank and when it is dispensed at the nozzle this method provides detection for both tanks and piping
- Must have previous 12 months of complete SIR records.

# Pressurized Piping Requirements

Periodic line leak detection options:

## 1. Monthly Monitoring

- 12 months of SIR or Interstitial Monitoring results (0.2 gph)

## 2. Annual Line Tightness Testing

- By a Line Tightness Tester Certified for the test method. (0.1 gph)

## 3. Electronic Line Leak Detectors

- 12 months of passing 0.2 gph results or; annual 0.1 gph result

# Pressurized Piping Summary

*Pressurized Piping Leak Detection* requires one from Column A, and one from Column B

Column A		Column B
Catastrophic		Periodic
Automatic Line Leak Detector (Mechanical or Electric)	<b>AND</b>	Annual Line Tightness Test (0.1gph)
		Annual Electronic Leak line Detector result (0.1 gph)
		12 months of Electronic Leak Line Detector results (0.2 gph)
		12 months of SIR Records (0.2 gph)
		12 months of IM sensor status and alarm history reports

# Suction Piping

Pulls product from the tank using a suction pump in the dispenser.

Suction piping is indicated by the presence of a suction pump inside the dispenser (look for pulleys and belts).

There is no Submersible pump head in a sump above the tank.

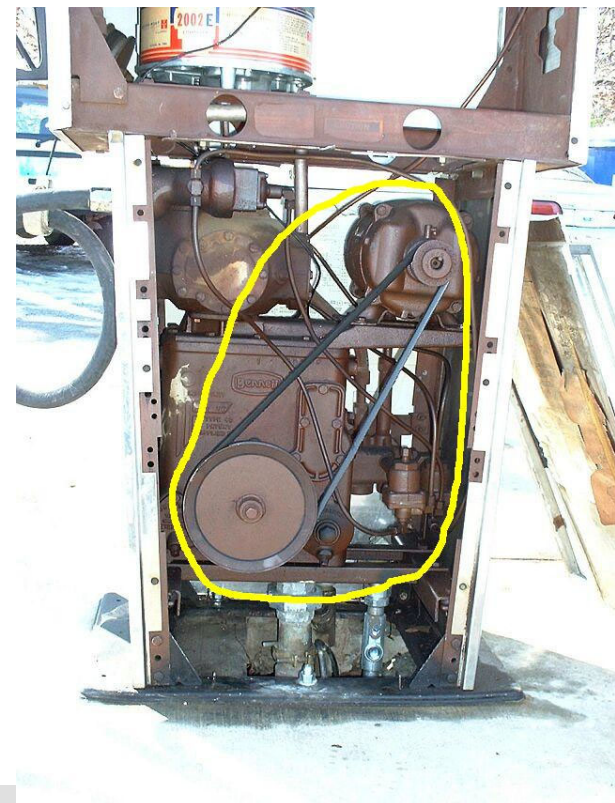
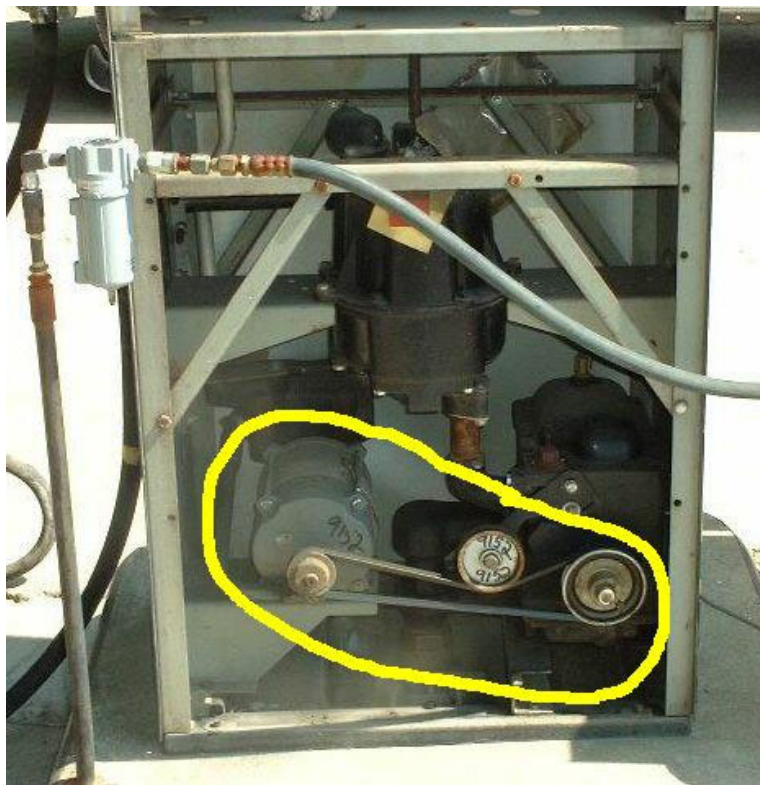

# Suction Piping Leak Detection

Suction piping must conduct leak detection by one of the methods below:

- **Line Tightness Testing**- Required every 3 years
- **Monthly Monitoring**-Previous twelve months of valid SIR or Interstitial Monitoring records

# Standard Suction “American Suction”

Leak detection is required for suction piping that has not been verified as “safe suction”.

- **Line Tightness Testing**- Required every 3 years
- **Monthly Monitoring**-Previous twelve months of valid SIR or Interstitial Monitoring records

When there is a line failure, product cannot drain into the tank and is released to the environment. Although the total release is relatively small, it can occur each time product is dispensed. Over a long period, this results in a significant cumulative effect.

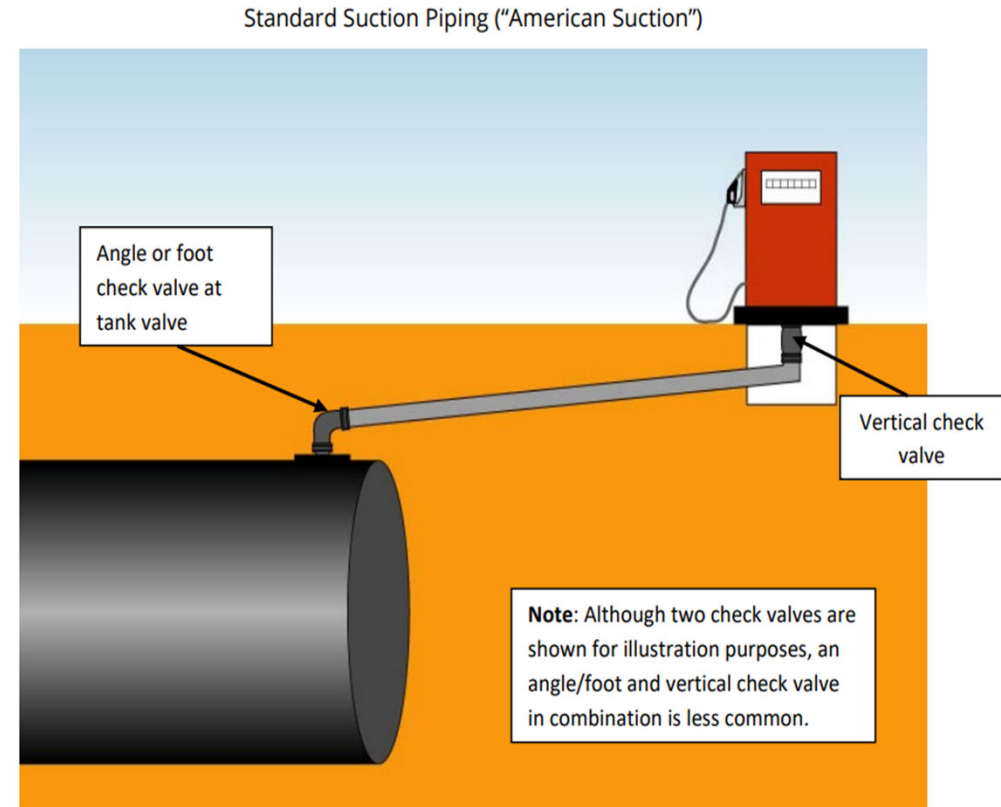

# Safe Suction “European Suction”

Leak detection is not required for suction piping that meets both the following conditions!

1. The pipng is sloped so product will drain back to the tank if suction is lost;
2. There is only one check valve located near the suction pump beneath the dispenser (and not at the tank).

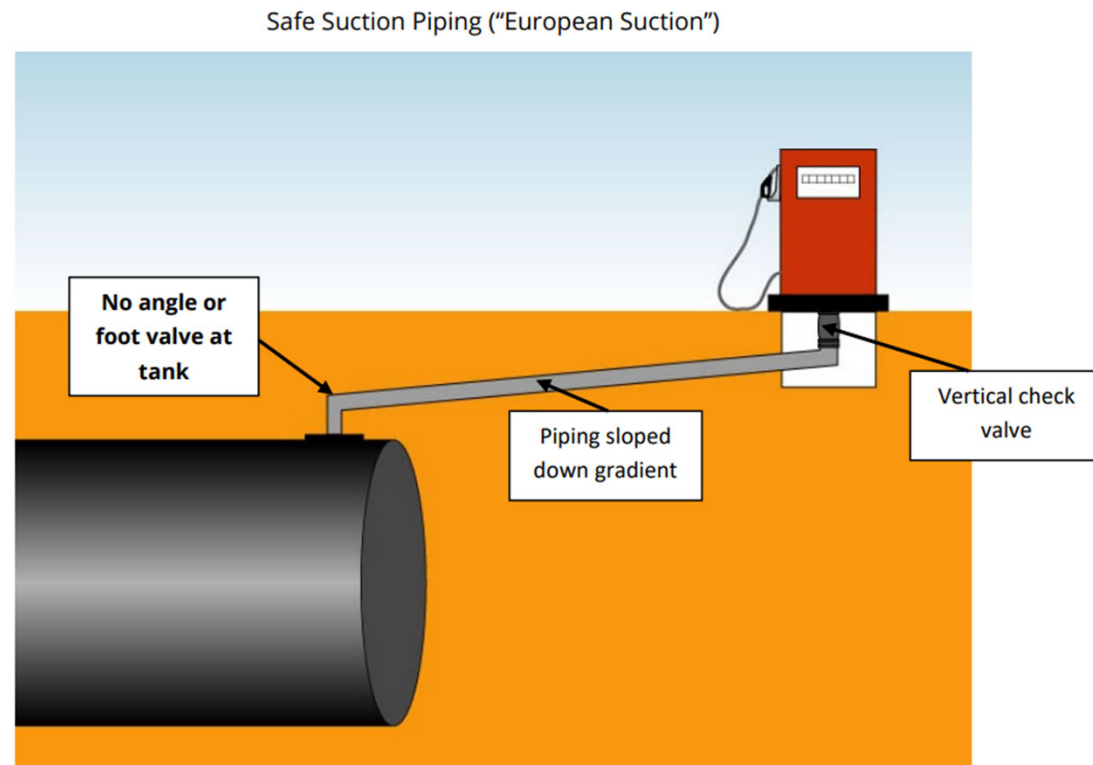

# Safe Suction a.k.a. 'European Suction'

However, leak detection is NOT required for suction piping that meets both the following conditions:

1. The pipng is sloped so product will drain back to the tank if suction is lost;

**AND**

2. There is only one check valve located near the suction pump beneath the dispenser (and not at the tank).

Piping that meets these criteria is called "**safe suction**".



# What You Must Know About Piping Leak Detection

- Know how to tell the difference between pressurized piping and suction piping.
- Pressurized piping must have two forms of leak detection. (catastrophic and periodic)
- Suction piping requires leak detection, unless it meets “safe suction” criteria.

# Complete IM and Piping Polls

- Please complete polling questions on bottom right of screen.

# We Have Covered...

- ✓ **Tanks and Piping**
- ✓ **Spill Prevention**
- ✓ **Overfill Prevention**
- ✓ **Corrosion Protection**
- ✓ **Leak Detection**

## **Next:**

**Annual Walkthrough Inspections, New Installation and Notification, Motor Fuel Dispensers**

# Annual Walkthrough Inspection

Annual walkthrough inspections are conducted once every 12 months and consist of the following:

Containment Sumps – visually check for damage, leaks to the containment area, or releases to the environment, remove liquid (in contained sumps) or debris; and, for double walled sumps with interstitial monitoring, check for a leak in the interstitial area.

Inspect Hand-held release detection equipment (gauging sticks) for operability and serviceability.

Annual walkthrough records must be maintained a minimum of **12 Months**

# Notification: UST System Installation

Notice of Installation is a 2- step process:

1. 15 days **prior to** installation, submit a Pre-installation notification form **and**
2. 15 days **after placing a tank in service** submit Notification form, CN-1260.

Alternative fuel forms must be submitted for tanks holding fuels containing more than 10% ethanol or 20% biodiesel.

# Before Placing Tank in Service

**Before** putting product in a tank for the first time:

1. The tank(s) must be registered.
2. Spill and overfill prevention must be in place.

**When product is first placed into tank:**

1. Begin leak detection.
2. Conduct tank and line tightness test **before** dispensing fuel.
3. Ball float valves may not be used for overfill prevention for new UST systems installed after October 13, 2018.

# Notification: Report These Changes

**An amended notification form for any changes to the status of the tanks at the facility must be submitted within thirty days of the change(s).**

## **For example:**

- Temporarily Out of Service (TOS) or Currently In Use (CIU)
- Tank or piping equipment
- Product stored
- Release detection method
- Address, or contact information
- Change of ownership\* (two forms required- Buyer Form and Seller Form)

Notification forms are available on the Division's website, or by request.

# Motor Fuel Dispensers

- **All** motor fuel dispensers must be inspected quarterly.
- Quarterly dispenser inspections can be documented on the monthly walkthrough form.

### III. QUARTERLY (EVERY 3 MONTHS)

If applicable this section can be used in lieu of the Division's Quarterly Dispenser Inspection Log (form CN-1287)

1. Visually inspect under dispensers. \* If a petroleum leak is observed or evidence of petroleum staining is found, make applicable repairs and document in the COMMENTS / ACTION TAKEN section on page 4 (include dispenser number and action taken). If necessary, follow suspected release reporting criteria.

Date: <input type="text"/>	Date: <input type="text"/>	Date: <input type="text"/>	Date: <input type="text"/>
Initials: <input type="text"/>	Initials: <input type="text"/>	Initials: <input type="text"/>	Initials: <input type="text"/>

IN THE FOLLOWING COMMENT SECTION, EXPLAIN ANY ACTIONS TAKEN TO ADDRESS ISSUES FOUND DURING WALKTHROUGH

DATE	ACTION TAKEN
<input type="text"/>	<input type="text"/>
<input type="text"/>	<input type="text"/>
<input type="text"/>	<input type="text"/>



# All New Motor Fuel Dispenser Installations Require Secondary Containment

- Secondary Containment or Under Dispenser Containment (UDC) is required for new motor fuel dispensers installed after **July 24, 2007**.
- Secondary containment must prevent releases to the environment and contain a release until it can be detected and removed.
- Must be liquid tight and product compatible.
- Safe suction piping does not require secondary containment.

# Secondary Containment at New Installation



Dispenser containment sumps with secondarily contained piping

# UDC (Under Dispenser Containment)



Under dispenser containment sumps

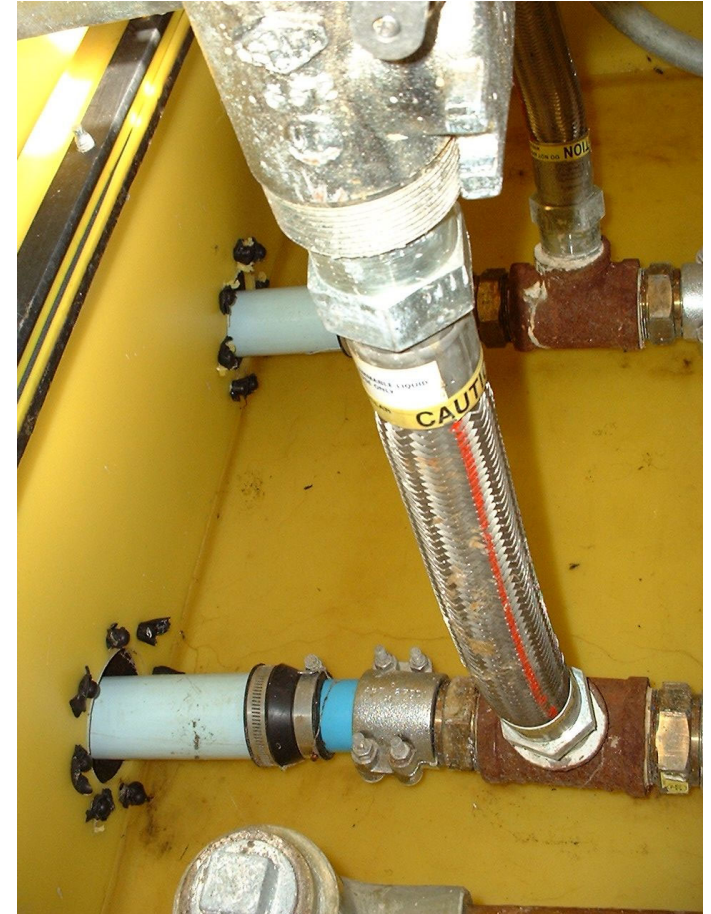

Impact/Shear valves

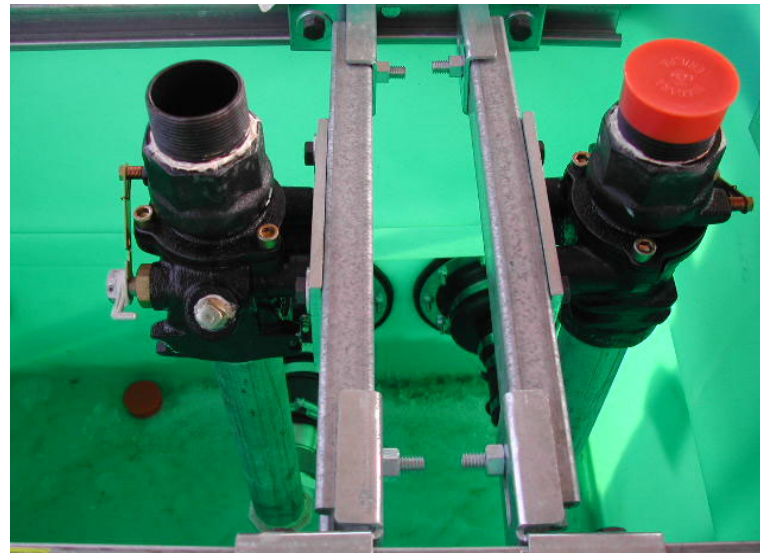

# UDC and Dispenser Replacement

- UDC is required when dispenser and “connecting equipment” is replaced.
- Connecting equipment is equipment below the:
  - Impact/Shear valve in pressurized systems
  - Union check valve in suction systems

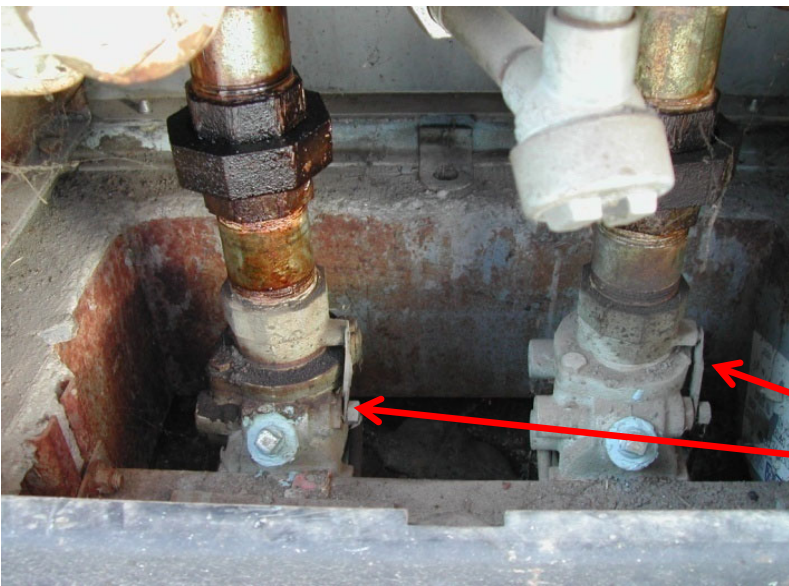

union check valve

impact valve

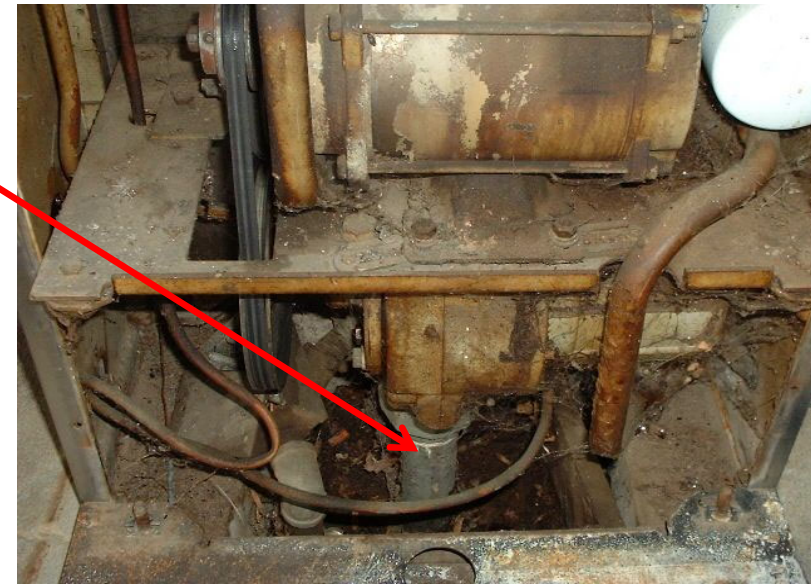

# We Have Covered...

- ✓ **Tanks and Piping**
- ✓ **Spill Prevention**
- ✓ **Overfill Prevention**
- ✓ **Corrosion Protection**
- ✓ **Leak Detection**
- ✓ **Notification, New Installation, and Motor Fuel Dispensers**

**Next:**

**TOS, Record keeping, and Suspected Releases**

# Temporarily Out of Service (TOS)

Definition: A UST system is **empty** when all materials have been removed using commonly employed practices so that no more than **one-inch (1")** of residue remains in the system.

## TOS Requirements:

- Cathodic protection system (if present) must remain operational which includes:
  - The two most recent 3 Year Cathodic Protection tests.
  - Three most recent 60 Day Rectifier Readings (impressed current).
- If TOS more than 3 months, pumps, lines, manways and ancillary equipment must be secured.
- If the TOS UST system is empty, no monthly release detection is required.
- Release detection must be performed when greater than one-inch is in the UST system.

# Temporarily Out of Service (TOS)

## Additional TOS Requirements:

- TOS UST systems are required to have spill and overfill prevention equipment installed.
- If TOS UST system is empty, the three-year spill and overfill device testing is not required.
- Three-year spill and overfill device testing is required when greater than one-inch is in the UST system.

# Record Keeping Requirements

You must keep the following records:

1. Leak Detection Records
2. Cathodic Protection Records
3. Repair Records
4. Closure Records
5. Certain Installation and Operational Records





# This is NOT Record Keeping



# Best Management Practice for Record Keeping

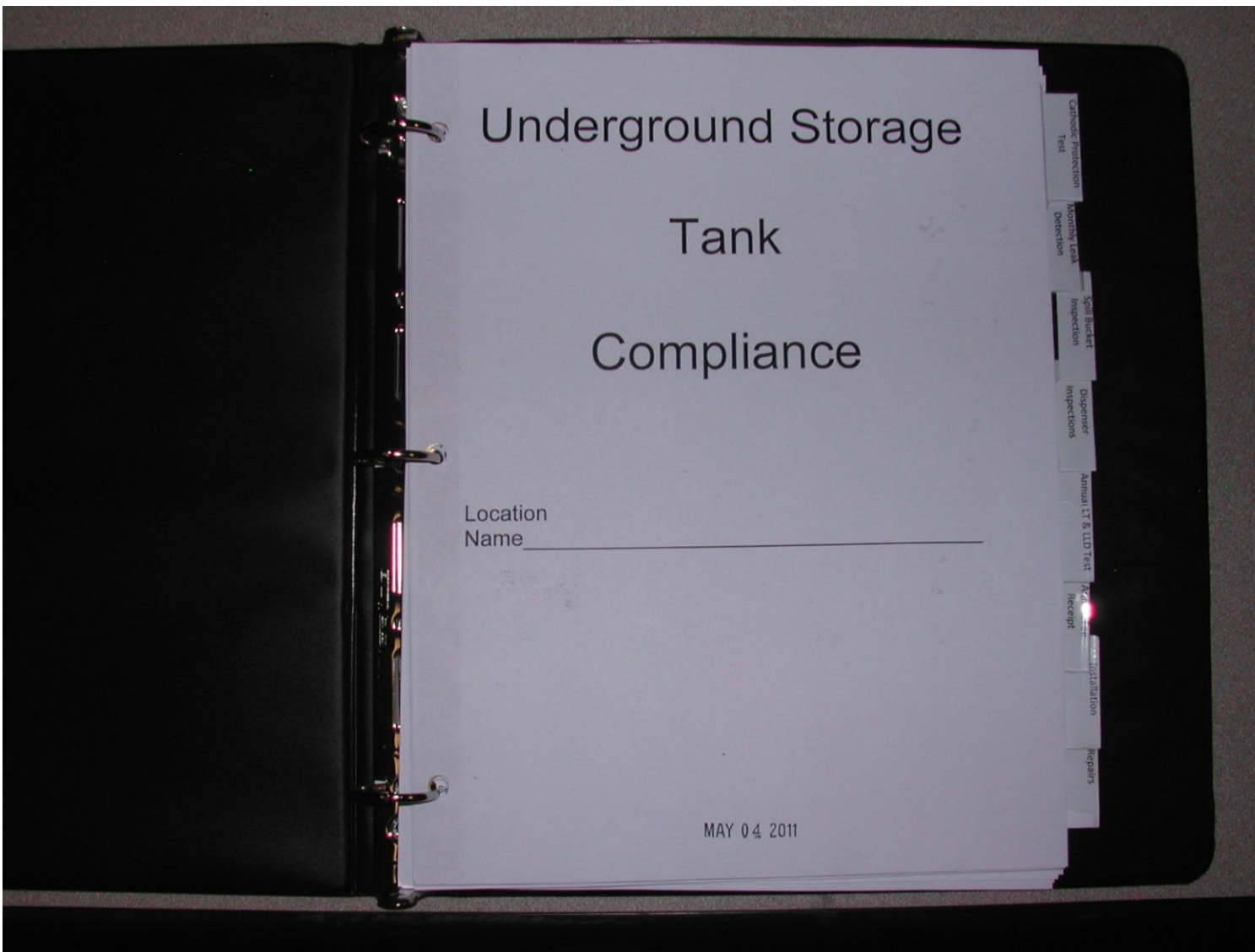

Maintaining compliance documentation in a 3-ring binder with tabs/dividers can make locating information for inspections much easier.

# Installation/Operational Records

**Keep these records for the life of the system:**

1. Initial tank/line tightness test results.
2. Any and all records regarding tank installation
3. All records regarding CP system repairs
4. Tank/line tightness testing results following CP system repair
5. All tank and piping repair records

**\*\*\*These records must be passed on to subsequent tank owner\*\*\***

# Release Detection Record Keeping

- 12 months of leak detection results
- Monthly and annual walkthrough form
- The last 3 Annual Line Leak Detector test results
- Annual Line Tightness Test or 12 months of piping monthly monitoring results
- Non safe suction line tightness test results must be kept for at least 3 years
- The last three annual ATG/sensor operability test results, if applicable
- Records of all **leak detection system** maintenance, service, or repairs 1 year from date of repair.

# Cathodic Protection Record Keeping

1. The last two cathodic protection system tests.  
(these must be done every 3 years by a cathodic protection tester)
2. The last three rectifier inspections when impressed current is used.  
(these must be done every 60 days typically by a tank owner or operator)

# Monthly Walkthrough Records

- Maintain records of monthly walkthrough inspections conducted every 30 days and consist of the following:
  - Inspect spill prevention for liquid, debris and/or damage.
  - Visually inspect the tank fill riser drop tube and flapper valve (if present) and fill cap for damage.
  - Delivery invoices if spill buckets are checked less than every thirty (30) days due to infrequent deliveries.
  - Operability of release detection equipment,
  - Presence of alarms or other unusual operating conditions.
  - Review of current release detection records.
  - Monthly walkthrough records must be maintained a minimum of 12 months.

# Annual Walkthrough Records

Maintain annual walkthrough inspection records for one (1) year, including:

- 1) A list of each containment area checked
- 2) If each area was acceptable or needed action taken
- 3) Description of actions taken to correct an issue
- 4) Hand-held release detection equipment checked.

## IV. ANNUAL WALKTHROUGH INSPECTION

1. Visually check containment sumps for damage and leaks to the containment area or a release to the environment. If applicable, follow * procedures in Section III.1 above.	Date: <input type="text"/>	Initials: <input type="text"/>
2. Remove any debris and liquid from containment sumps that are required to be liquid tight. If applicable, follow * procedures in Section III.1 above.	Date: <input type="text"/>	Initials: <input type="text"/>
3. If Interstitial Monitoring is being performed, check for leaks in the interstice of the double wall containment sumps (if applicable) that are continuously monitored with a sensor connected to a monitoring console, for example an ATG.	Date: <input type="text"/>	Initials: <input type="text"/>
4. Check tank gauging sticks for operability and serviceability. (SIR or Manual Tank Gauging Only)	Date: <input type="text"/>	Initials: <input type="text"/>

# Permanent Closure Record Keeping

Records that demonstrate compliance with UST system closure requirements and results of closure assessment must be maintained for **3 years** after completion by:

 - the former owner who closed the UST system,  
**or**

 - the current owner of the location, **or**

 - mailing these records to the Division.



# We Have Covered...

- ✓ **Tanks and Piping**
- ✓ **Spill Prevention**
- ✓ **Overfill Prevention**
- ✓ **Corrosion Protection**
- ✓ **Leak Detection**
- ✓ **Notification, New Installation, and Motor Fuel Dispensers**
- ✓ **TOS, and Record Keeping,**

**Next:**

**Red Tags , Release Reporting, Financial Responsibility,**

# Red Tags



# A few words about Illegal deliveries...

- Occurs when deliveries are made to tanks that have been red tagged.
- Violation for the tank owner AND delivery company
- Web listing to inform delivery companies of locations with red tags.

<https://www.tn.gov/environment/program-areas/ust-underground-storage-tanks/ust/sites-under-delivery-prohibition.html>

MIDDLE & EAST TENNESSEE AMBER ALERT: CARLIE TRENT | CLICK FOR DETAILS FROM TBI.



# Underground Storage Tanks

The mission of the Division of Underground Storage Tanks is to protect human health and environment by preventing future petroleum underground storage tank releases and remediating existing petroleum underground storage tank contamination.

**Contacts & Events**

[Read More](#)

**DO NOT DELIVER**  
Any delivery violates T.C.A. 68-215-106(e)  
Delivery can result in a fine up to \$10,000.  
T.C.A. 68-215-121  
Unauthorized tag removal is a Class C misdemeanor.  
Contact the Division of UST at (615) 532-0945

**DO NOT FILL**  
0000012

**Sites under Prohibition**

Facilities appearing on this list should not be receiving petroleum deliveries, nor should they be selling petroleum.

**Forms & Guidance**

[Read More](#)



# Spill and Overfill Reporting - 25 Gallon Rule

**SPILL:** Fuel released to the surface of the ground during the transfer of petroleum to a UST system.

**OVERFILL:** Fuel released during the transfer of petroleum by filling the UST system over its capacity.

A spill or overfill **less than 25** gallons:

- Must be contained and immediately cleaned up and;
- If not contained and cleaned up within 72 hours must be reported.

A spill or overfill **more than 25** gallons:

- Must be contained and immediately cleaned up and;
- Report within 72 hours and begin corrective action.

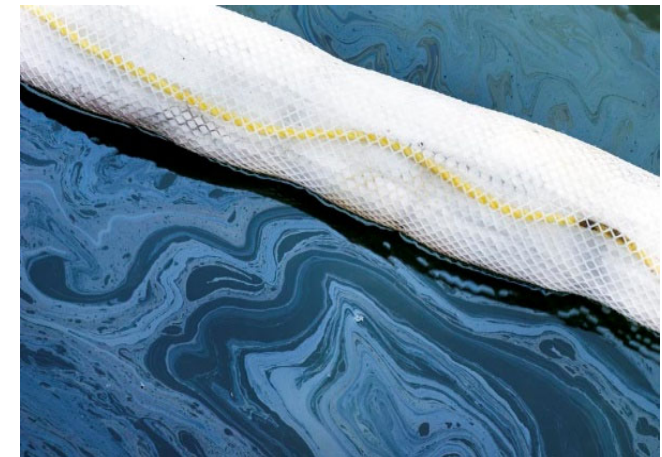

# Reporting Releases

## All suspected or confirmed releases must be reported to the Division within 72 Hours!

### Examples of Suspected Releases:

- Failed Monthly ATG Report (sudden water ingress, erratic dispensing, etc.)
- Failed Monthly SIR Report
- Two Consecutive SIR Inconclusive Reports
- Failed Monthly 0.2 ELLD Test
- Tank Interstice Alarm
- Unusual operating condition
- Failed Annual 0.1 ELLD Test (if 12 months 0.2 gph test not available.)
- **\*Failed Annual Line Test\***

## Why is it so important to report suspected release?

# Financial Responsibility

Tennessee UST regulations state a tank owner or operator must be financially responsible for a leak from a UST system. This means:

1. You must be able to pay for the cost of cleaning up contamination, and/or for
2. Compensating third parties for property damage and/or bodily injury.

The cost of cleaning up a release can be

**HIGH**

# Help Is Available

Tennessee has a Fund to help with these expenses, but tank owners must pay a portion of cleanup costs.



Cost of cleanup

Which portion of these costs would you prefer to pay?



# Petroleum Underground Storage Tank Fund

- The UST fund was established to help tank owners afford the remediation cost of petroleum releases.
- Monetary funding:
  - Environmental assurance fee of four tenths of one cent (0.4¢) per gallon on each gallon of petroleum products imported into Tennessee and petroleum products manufactured in Tennessee
- The fund reimburses up to \$2 million dollars for a release and up to \$1 million dollars for third party damages.
- To date, the fund has paid out over \$344 million in cleanup costs.
- Fund entry level (“deductible”) is based upon:
  - Operational compliance status at the time of the release
  - Criteria of release detection technology and type of UST system construction

# The bottom line...

If a tank owner/operator **fails** to:

1. Timely submit a Fund Eligibility application, they will not receive reimbursement. Application deadlines are spelled out under statute T.C.A. §68-215-111(f)(7).
2. Submit records demonstrating operational compliance could result in a higher fund deductible.



# Complete Section Poll

- Please complete polling questions on bottom right of screen.

# We Have Covered...

- ✓ **Tanks and Piping**
- ✓ **Spill Prevention**
- ✓ **Overfill Prevention**
- ✓ **Corrosion Protection**
- ✓ **Leak Detection**
- ✓ **Notification, New Installation, and Motor Fuel Dispensers**
- ✓ **TOS, and Record Keeping,**
- ✓ **Red Tags and Financial Responsibility**

**Next:**

# TEST TIME!



# End of Class Information

- The final exam will be sent to you by email, you must complete the final exam before leaving the class
- Notify the instructors when you complete the final exam. You can use the WebEx chat, email or text to notify at least one of the instructors.
- Mitzie Berry – 423-797-1404 / [Mitzie.Berry@tn.gov](mailto:Mitzie.Berry@tn.gov)
- David Stone – 865-315-2323 / [J.David.Stone@tn.gov](mailto:J.David.Stone@tn.gov)
- Jessie Hussey – 865-333-1277 / [Jessica.Hussey@tn.gov](mailto:Jessica.Hussey@tn.gov)
- Casey Norris – 901-237-0106 / [Casey.Norris@tn.gov](mailto:Casey.Norris@tn.gov)