

# Wastewater Treatment Laboratory Week 2

Course #2222

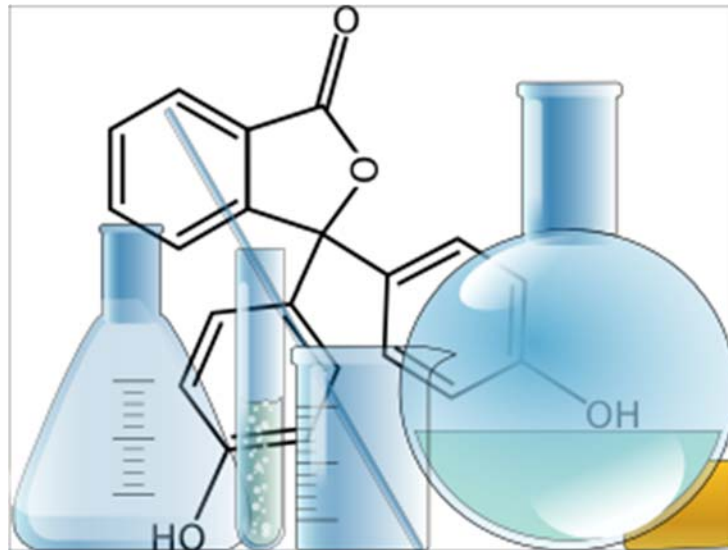

April 4-8, 2022







# Wastewater Treatment Laboratory—Week 2

April 4-8, 2022

Course #2222

## Monday:

- 8:30 Welcome and Class Introduction
- 8:45 Chlorine Presentation
- 10:00 Solutions Chemistry
- 11:00 Lunch
- 12:00 Chlorine Analysis
  - Chlorine Calibration Standard Solutions
  - MDL Calculator

## Tuesday:

- 8:30 Ammonia Presentation
- 9:45 Ammonia Lab
  - Preliminary Distillation
- 11:30 Lunch
- 12:30 Ammonia Lab—Continued
  - Electrode Method
  - TNT Method
- 2:00 Nutrient Presentation

## Wednesday:

- 8:30 Nutrient Lab Analysis
  - TNT Methods: Nitrate, sTKN, Phosphorus
- 11:30 Lunch
- 1:00 Tour—TBD

## Thursday:

- 8:30 Alkalinity Presentation
- 9:30 Alkalinity Analysis
- 11:00 Lunch
- 12:00 Process Control Presentation and Lab Analysis
  - OUR/SOUR
  - Settleometer/MLSS/SVI
  - Microscopic Evaluation

## Friday:

- 8:30 WET Testing Presentation
- 10:00 Oil and Grease Presentation
- 11:00 Exam Review
- 12:00 Lunch
- 1:00 Final Exam



**Instructor: Sarah Snyder**

**Phone: 615-898-6506**

**Fax: 615-898-8064**

**E-mail:  
Sarah.Snyder@tn.gov**

**Fleming Training Center  
2022 Blanton Dr.  
Murfreesboro, TN 37129**





# Table of Contents

## Section 1:

<b>Laboratory Basics.....</b>	<b>3</b>
Lab Safety .....	4
GHS of Classification, Labeling, and SDS .....	24
Lab Equipment .....	36
Laboratory Vocabulary.....	49
Cleaning Glassware .....	54
How to Read a Meniscus.....	55
Sampling.....	56

## Section 2:

<b>Solutions Chemistry .....</b>	<b>63</b>
----------------------------------	-----------

## Section 3:

<b>Chlorine .....</b>	<b>79</b>
-----------------------	-----------

## Section 4:

<b>Ammonia .....</b>	<b>115</b>
----------------------	------------

## Section 5:

<b>Nutrients .....</b>	<b>153</b>
------------------------	------------

## Section 6:

<b>Alkalinity .....</b>	<b>207</b>
-------------------------	------------

## Section 7:

<b>Process Control.....</b>	<b>233</b>
-----------------------------	------------

## Section 8:

<b>Whole Effluent Toxicity Testing .....</b>	<b>273</b>
--	------------

## Section 9:

<b>Oil and Grease .....</b>	<b>281</b>
-----------------------------	------------

## Section 10:

<b>Answers to Review Questions.....</b>	<b>285</b>
---	------------



**Section 1**  
**Lab Basics**



Wastewater Laboratory Class

## Laboratory Safety



## Safety

- Operators work around many different kinds of hazards on a daily basis
  - Electrical
  - Bacteriological/Viral
  - Confined space
  - Mechanical
  - Traffic



## Safety

- Occupational Safety and Health Act (OSHA)
  - Demands that proper safety procedures be exercised in the lab at all times
  - "each employer has the general duty to furnish all employees with employment free from recognized hazards causing, or likely to cause, death or serious physical harm"
- TOSHA
  - Contact [local office](#) for specific questions

## Laboratory Hazards

- Infectious Materials
- Poisons
- Explosions
- Cuts and Bruises
- Electric Shock
- Toxic Fumes
- Fire
- Burns



## Be Aware

- Learn the lay-out of the lab
  - Emergency exits
  - Emergency routes
  - Emergency ventilation system
  - Fire-fighting equipment locations/ know how to use it
  - Eye wash station/Emergency shower
  - First Aid equipment
  - Emergency phone numbers

## Infectious Materials

- Wastewater and sludge contain millions of microorganisms
- Some are infectious and can cause disease
  - Tetanus
  - Typhoid
  - Dysentery
  - Hepatitis
  - Parasitic worms



## Infectious Materials

- Change out of work clothes before leaving
  - Prevent spread of infectious material into your home
- Inoculations from doctor/health dept.
  - Tetanus, polio, hepatitis A and B
  - Diseases contracted through breaks in skin, cuts, puncture wounds
  - Wastewater risk: breathing contaminated air

## Infectious Materials

- Always wash hands with soap and water, especially before handling food or smoking
  - Hand sanitizer is not sufficient
- Never pipet by mouth
  - Could lead to serious illness or death
  - Use mechanical or rubber bulbs
- Never drink from a beaker or other lab glassware



## Corrosive Chemicals

- Acids: a chemical substance that neutralizes alkalis, dissolves some metals; turns litmus paper red; typically a corrosive liquid
- Extremely corrosive to human tissue, metals, clothing, wood, cement, stone, concrete
- Sulfuric acid ( $H_2SO_4$ )
- Hydrochloric or muriatic (HCl)
- Nitric ( $NHO_3$ )
- Glacial acetic ( $H_4C_2O_2$ )

## Corrosive Chemicals

- Bases: turn litmus paper blue, pH greater than 7
- Extremely corrosive to skin, clothing, and leather
- Sodium hydroxide, aka "caustic soda" or "lye" (NaOH)
- Potassium hydroxide (KOH)
- Chlorine (and other oxidants)

## Corrosive Chemicals

- Commercially available chemical spill clean-up materials should be kept on hand
- Baking soda (bicarbonate) effectively neutralizes acids
- A jug of ordinary vinegar can be kept on hand to neutralize bases

## Toxic Materials

- Solids:
  - Cyanide, chromium, heavy metals
- Liquids:
  - Chlorine, nitric acid, ammonium hydroxide, chloroform, organic solvents
- Gases:
  - Chlorine, ammonia, hydrogen sulfide, sulfur dioxide, and chlorine dioxide

## Explosive or Flammable Materials

- Liquids:
  - Acetone, ethers, gasoline, benzene
- Gases:
  - Propane, hydrogen, acetylene

## Personal Protective Equipment

- Known as **PPE**
- Safety Glasses
- Face Shield
- Lab Coat
- Lab Apron
- Gloves
  - Rubber, heat resistant
- Closed Toed Shoes
  - Steel-toed boots



## Personal Safety and Hygiene

1. Never work alone in the lab
  - In case of accident or fire
  - If necessary, have someone check on you regularly
2. Wear protective goggles or safety glasses at all times
  - Fumes can seep between contact lens and eyeball



## Personal Safety and Hygiene

3. Wear a face shield if there is danger of hot liquid erupting or flying glassware due to explosion
4. Wear protective or insulated gloves when handling hot or cold objects, or when handling liquids or solids that are skin irritants



## Personal Safety and Hygiene

5. Always wear a lab coat or apron
6. Never pipet by mouth
7. Never eat or smoke in the lab
8. Do not keep food in a refrigerator that is used for chemical or sample storage



## Personal Safety and Hygiene



Avoid using cell phones and other personal electronic devices in the laboratory!  
Remove gloves, wash hands, then use the device.



Partners and with permission of Cornell University  
Original source: [www.cornell.edu/ehp/ehp.html](http://www.cornell.edu/ehp/ehp.html)

Nebraska  
Department of Health & Senior Services  
2012-12-10/13

## Personal Safety and Hygiene

9. Use ventilated lab fume hoods when handling toxic chemicals



- Average "face" velocity of 100 fpm with a min of 70 fpm at any point
- If carcinogens are handled, a face velocity of 150 fpm required
- Verification that air flow is active at each hood

## Personal Safety and Hygiene

9. Maintain clear access to emergency eye wash stations/showers
- Flush weekly (OSHA)
  - Flush monthly (SAC Vol II)
  - Short flexible tube to wash chemicals off skin
10. Practice good housekeeping to prevent accidents



## Personal Safety and Hygiene

11. Never look into the open end of a container during a reaction or when heating a container
12. Always check labels on bottles to make sure you selected the proper chemical
- Unlabeled containers only allowed if the are dispensed immediately after use
13. Never handle chemicals with bare hands
- Use spoon or spatula

## Personal Safety and Hygiene

14. Unsafe glassware is the largest single cause of accidents in the lab
- Fire polish chips – slowly heat chipped area until it reaches a temp at which glass will begin to melt, remove from heat, allow to cool
  - Never hold glassware (or equipment) with bare hands while heating
    - Use gloves and/or suitable tool
15. Special receptacle for broken glass

## Manufacturer Label Requirements

1. Product Identifier: The name used for a hazardous chemical on the label and in the SDS
2. Pictogram
3. Signal Word: Used to indicate the relative level of severity of hazard and alert the reader to a potential hazard
  - Danger—more severe hazard
  - Warning—less severe hazard
4. Hazard Statement: describes the nature of the hazard
5. Precautionary Statement: describes recommended measures that should be taken to minimize or prevent adverse effects resulting from exposure or improper storage or handling

HCS Pictograms and Hazards		
<b>Health Hazard</b>  <ul style="list-style-type: none"> <li>• Carcinogen</li> <li>• Mutagenicity</li> <li>• Reproductive Toxicity</li> <li>• Respiratory Sensitizer</li> <li>• Target Organ Toxicity</li> <li>• Aspiration Toxicity</li> </ul>	<b>Flame</b>  <ul style="list-style-type: none"> <li>• Flammables</li> <li>• Pyrophorics</li> <li>• Self-Heating</li> <li>• Emits Flammable Gas</li> <li>• Self-Reactives</li> <li>• Organic Peroxides</li> </ul>	<b>Exclamation Mark</b>  <ul style="list-style-type: none"> <li>• Irritant (skin and eye)</li> <li>• Skin Sensitizer</li> <li>• Acute Toxicity</li> <li>• Narcotic Effects</li> <li>• Respiratory Tract Irritant</li> <li>• Hazardous to Ozone Layer (Non-Handatory)</li> </ul>
<b>Gas Cylinder</b>  <ul style="list-style-type: none"> <li>• Gases Under Pressure</li> </ul>	<b>Corrosion</b>  <ul style="list-style-type: none"> <li>• Skin Corrosion/Burns</li> <li>• Eye Damage</li> <li>• Corrosive to Metals</li> </ul>	<b>Explosion Bomb</b>  <ul style="list-style-type: none"> <li>• Explosives</li> <li>• Self-Reactives</li> <li>• Organic Peroxides</li> </ul>
<b>Flame Over Circle</b>  <ul style="list-style-type: none"> <li>• Oxidizers</li> </ul>	<b>Environment (Non-Handatory)</b>  <ul style="list-style-type: none"> <li>• Aquatic Toxicity</li> </ul>	<b>Skull and Crossbones</b>  <ul style="list-style-type: none"> <li>• Acute Toxicity (fatal or toxic)</li> </ul>





## Chemical Storage

- Store acids and bases in separate storage cabinets
- If incompatible chemicals are inadvertently mixed a fire, explosion, or toxic release can easily occur
- For especially dangerous materials, use a secondary container (e.g. plastic tub) large enough to contain a spill of the largest container

## Chemical Storage



## Moving chemicals

- Use cradles or tilters for carboys or other large chemical vessels
- Use a trussed hand truck for transporting cylinders of compressed gas
- Never roll a cylinder by its valve
- Clamp securely into place to prevent shifting or toppling
- Carry flammable liquids in safety cans
  - Gloves, safety shoes, rubber apron

## Proper lab technique

- Acids and other corrosives
  - Flush outside of acid bottles with water before opening
  - Do not lay stopper/lid on counter where person may rest arm or hand
  - Keep all acids tightly stoppered when not in use
  - Immediately clean up spills

## Proper lab technique

- Always add acid to water
  - If you pour water into acid, violent splashing may occur

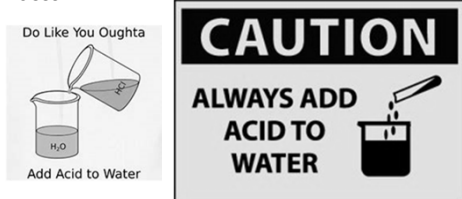

## Mercury

- Even a small amount of spilled mercury can poison the atmosphere in a room
- To clean up a small spill (amount in a thermometer):
  - Put on rubber, nitrile, or latex gloves
  - Use squeegee or cardboard to sweep mercury beads together
  - Use disposable dropper/pipet to suck up beads
  - Slowly squeeze mercury onto damp paper towel
  - Place in labeled zip lock bag for proper disposal



## Electric shock

- Follow the usual “do’s” and “do not’s”
- Ground all apparatus with 3 prong plugs
- Do not continue to run a motor after liquid has spilled on it
  - Turn off immediately, clean and dry inside thoroughly before use
- Electrical units operated in an area exposed to flammable vapors should be explosion proof

## Cuts

- Some lab glassware must be inserted through rubber stoppers
  - Glass tubing, thermometers, funnels
  - Ends should be flame polished and either wetted or lubricated
    - Never use oil or grease
  - Wear gloves
  - Hold tubing as close to end being inserted as possible to prevent bending/breaking
- Never force rubber tubing or stoppers from glassware

## Cuts

- Examine all glassware before use
  - Discard any broken pieces in the appropriate sharps container
- Never store broken glassware in cabinets
  - Damaged glassware should either be sent for repair or disposed of properly
- Use gloves when sweeping up broken glass, do not use bare hands
  - Pick up fine glass particles with wet paper towel

## Burns

- Immediately wash off splatterings of acids, caustics, and strong oxidizers with large amounts of water
- Every worker should have access to a sink and emergency deluge shower
- Keep vinegar and baking soda handy to neutralize bases and acids
  - Vinegar neutralizes bases
  - Baking soda neutralizes acids

## Burns

- Heat resistant gloves
- Safety tongs to handle hot glassware
  - Do not juggle from hand to hand
- Most harmful and painful chemical burn = Eyes
  - Immediately flood eyes with water or special eyewash solution
  - Rinse within 1 minute of the burn
  - Flush at least 20 minutes
  - Consult doctor
- Alkali powder (such as lime) should be brushed off before adding water

## First Aid

- First Aid box should:
  - Be easy to access
  - Be easy to identify
  - Be adequately stocked (re-stocked quickly after use)
    - Contain a copy of basic first aid instructions
- Call 911 for major accidents
- Notify manager ASAP



## Toxic Fumes

- Use ventilated fume hood
  - Work at least 6 inches inside the hood
  - Annual maintenance
- Do not store chemicals in fume hood
  - Can impede proper air flow
  - Do not block rear exhaust slot
- When working with chlorine and other toxic substances, always wear a self-contained breathing apparatus

## Waste Disposal

- Corrosive materials should never be poured down the sink
  - Corrode the drain pipe or trap
- Corrosive acids should be neutralized and poured down corrosive-resistant sinks
  - Use large amounts of water to dilute and flush
- Broken glassware goes into designated sharps container



## Waste Disposal

- Do not place incompatible chemicals in same trash bag
- Store hazardous waste containers in a secondary container to prevent uncontrolled leaks
- Containers should be DOT approved for ultimate transport off site
- Keep hazardous waste container closed
  - Do not open, handle, or store in a manner that may cause it to rupture or leak

## Waste Disposal

- At least weekly, inspect areas where hazardous waste containers are stored
  - Look for evidence of leaks and deterioration
  - Take corrective action as required
- Label containers with hazardous waste, label describing the waste contained and date that accumulation started

## Chemical Hygiene Plan

- All treatment plants that have a laboratory should have a chemical hygiene plan
  - SOPs for using/handling hazardous chemicals
  - Criteria to reduce employee exposure, PPE, etc.
  - Operation of fume hoods to comply with regulatory requirements
  - Employee training – hazard communication
  - Provisions for medical consultation and exams
  - Assignment of chemical hygiene officer
  - Provisions for employee protection when working with carcinogens and reproductive toxins

## Fire

- Lab should be equipped with a fire blanket
  - Smother clothing fires
- Small fires in evaporating dish or beaker can be extinguished with
  - Glass plate
  - Wet towel
  - Wet blanket
- Do not use fire extinguisher on small beaker fire

## Fire

- You must use the proper fire extinguisher for each class of fire
- Ex: Never pour water onto grease fires, electrical fires, or metal fires
  - Increase the hazard – splattering the fire or electric shock
- Fires are classified according to the materials being consumed
  - A,B,C, or D

## Fire

- **Class A** = Ordinary combustibles
  - Wood
  - Paper
  - Cloth
  - Rubber
  - Many plastics
  - Grass, hay
- Use foam, water, soda-acid, carbon dioxide gas, or almost any type of extinguisher



## Fire

- **Class B** = Flammable and combustible liquids
  - Gasoline
  - Oil
  - Grease
  - Tar
  - Oil-based paint
  - Solvents
  - Flammable gases
- Use foam, carbon dioxide, or dry chemical extinguishers



## Fire

- **Class C** = Energized electrical equipment
  - Starters
  - Breakers
  - Motors
- Use carbon dioxide or dry chemical extinguishers to smother the fire
  - Both types are nonconductors of electricity



## Fire

- **Class D** = Combustible metals
  - Magnesium
  - Sodium
  - Zinc
  - Potassium
- Use a Class D extinguisher or use fine dry soda ash, sand, or graphite to smother the fire
- Operators rarely encounter this type of fire



## Fire Extinguishers

- A multipurpose ABC carbon dioxide extinguisher will handle most laboratory fires
  - Visual inspection – monthly
  - Maintenance check – annually
- Consult with your local fire dept. about best methods to use for specific hazards that exist at your facility

## Fire Extinguishers

1. Pull the pin out
2. Aim the nozzle at the base of the fire
3. Squeeze the handle
4. Sweep the nozzle/spray from side to side
  - To contain the fire



## Fire Prevention Practices

1. Maintain a neat and clean work area
2. Putting oil and paint-soaked rags in covered metal containers and regularly disposing of them in a safe manner
3. Observe all "no smoking" signs
4. Keep fire doors, exits, stairs, fire lanes, and firefighting equipment clear of obstructions
5. Keeping all combustible materials away from furnaces or other sources of ignition

## Fire Prevention Reminders

- Prevent fires by good housekeeping and proper handling of flammables
- Action in the first few seconds of ignition usually means the difference between destruction and control
- Know the proper fire extinguisher to use
- Learn how to operate the extinguishers *before* an emergency
- In necessary, evacuate immediately

## Water Supplies

- Inspect for cross connections
  - Water seals on pumps
  - Feed water to boilers
  - Hose bibs below grade where they could be subject to flooding with wastewater or sludges
- Install Air Gap device
  - Best backflow prevention method
- Never drink from outside water connections such as faucets and hoses
  - The hose could have been used to carry effluent or untreated wastewater
- Post signs that water is not potable where applicable

## Pregnancy

- Pregnant women should avoid teratogens
  - Teratogen = reproductive toxins that may cause damage to the fetus
- Ask supervisors to alter schedules/work assignments if the potential for exposure exists
- THM Plus method (Trihalomethanes) by Hach uses Chloroform, a teratogen

## Key Points to Remember

- Be aware of the hazards around you
- Educate yourself
- Review safety procedures on a regular basis
- Take charge of your own safety
- Don't get complacent

**Any Questions?**

## Laboratory Safety – Review Questions

1. List at least 5 laboratory hazards.
2. Why should you never work alone in the laboratory?
3. You may add acid to water, but never add water to acid. True or False?
4. How would you dispose of a corrosive acid?
5. What does SDS stand for?
6. How long should SDS's be kept on file?
7. What is a signal word? List the 2 signal words that could be found on a chemical label and what each one represents.
8. What should you do if you get a chemical in your eyes?
9. What would you do if you spilled a concentrated acid on your hand?
10. List 4 types of Personal Protective Equipment.

11. Any work that has the potential to generate hazardous or toxic vapors or fumes should be conducted where?
12. What common household products should you keep on hand to neutralize acids and bases?
13. How often should (plumbed) eye wash stations and emergency safety showers be flushed?
14. Chemicals should be stored in alphabetical order for quick access. True or false?
15. Why must acids and bases be stored in separate cabinets?
16. How would you extinguish a small beaker fire?
17. List the 4 Classes of fire extinguishers mentioned in our presentation and the materials being consumed in each class.
18. What does P.A.S.S. stand for?
19. What is a teratogen?



## Lab Policies

1. No horse play.
2. No shorts or open-toed shoes.
3. No smoking, eating, dipping, or drinking in the lab.
4. Put broken glass in broken glass container, NOT IN THE TRASH.
5. Do not pipet by mouth.
6. Each day after class:
  - All used glassware will be washed in hot soapy water, rinsed in tap water, then DI water.
  - All counter top will be wiped clean with disinfectant.
  - Balance room must be clean.
7. Used pipets are placed in containers containing detergent immediately after use, tip up.
8. Acid spills must be cleaned up immediately.
9. Pipet bulbs must be cleaned immediately after over pipetting (getting liquid into the bulb).
10. Wear safety glasses when performing any experiment.
11. Wear aprons in the lab at all times.
12. Wear gloves when performing any experiment or washing glassware.
13. Wash your hands before leaving the laboratory.
14. Know where the eye wash stations are located and how to use them.
15. Know where the emergency shower is and how to use it.
16. Know where each fire extinguisher is located and how to use them.
17. Carefully read the Safety Data Sheets for all chemicals used in the laboratory.



U.S. Department of Labor

**OSHA**<sup>®</sup>  
Occupational Safety  
and Health Administration

# Job Safety and Health IT'S THE LAW!

## All workers have the right to:

- A safe workplace.
- Raise a safety or health concern with your employer or OSHA, or report a work-related injury or illness, without being retaliated against.
- Receive information and training on job hazards, including all hazardous substances in your workplace.
- Request an OSHA inspection of your workplace if you believe there are unsafe or unhealthy conditions. OSHA will keep your name confidential. You have the right to have a representative contact OSHA on your behalf.
- Participate (or have your representative participate) in an OSHA inspection and speak in private to the inspector.
- File a complaint with OSHA within 30 days (by phone, online or by mail) if you have been retaliated against for using your rights.
- See any OSHA citations issued to your employer.
- Request copies of your medical records, tests that measure hazards in the workplace, and the workplace injury and illness log.

*This poster is available free from OSHA.*

**Contact OSHA. We can help.**

## Employers must:

- Provide employees a workplace free from recognized hazards. It is illegal to retaliate against an employee for using any of their rights under the law, including raising a health and safety concern with you or with OSHA, or reporting a work-related injury or illness.
- Comply with all applicable OSHA standards.
- Report to OSHA all work-related fatalities within 8 hours, and all inpatient hospitalizations, amputations and losses of an eye within 24 hours.
- Provide required training to all workers in a language and vocabulary they can understand.
- Prominently display this poster in the workplace.
- Post OSHA citations at or near the place of the alleged violations.

FREE ASSISTANCE to identify and correct hazards is available to small and medium-sized employers, without citation or penalty, through OSHA-supported consultation programs in every state.



# OSHA INFOSHEET

## Health Effects from Contaminated Water in Eyewash Stations

**Eyewash stations used in workplaces must be maintained to prevent injury and illness to workers. This InfoSheet provides updated information on eyewash station hazards.**

**Eyewash stations are critical emergency safety equipment intended to mitigate eye injuries when control methods do not prevent exposure to a physical or chemical irritant or a biological agent. The ANSI standard for eyewashes specifies that eyewashes must be capable of delivering tepid flushing fluid to the eyes not less than 1.5 liters per minute (0.4 gpm) for 15 minutes after a single movement and subsequent hands-free operation. Whether the eyewash station is permanently connected to a source of potable water (i.e., plumbed) or has self-contained flushing fluid, improper maintenance may present health hazards that can worsen or cause additional damage to a worker's eye.**

### Where are eyewash stations used?

Eyewash facilities are required in workplaces where corrosive chemicals are used (29 CFR 1910.151(c)), as well as in HIV and HBV research laboratories and production facilities (1910.1030(e)(3)(i)), and where there is any possibility that an employee's eyes may be splashed with solutions containing 0.1 percent or greater formaldehyde (1910.1048(i)(3)). They may also be found in research and production laboratories, in medical facilities and other workplaces with materials that may cause injury to or infection of the eyes.

### How can improperly maintained eyewash stations cause infections?

Water found in improperly maintained eyewash stations is more likely to contain organisms (e.g., *Acanthamoeba*, *Pseudomonas*, *Legionella*) that thrive in stagnant or untreated water and are known to cause infections. When a worker uses an eyewash station that is not maintained, organisms in the water may come into contact with the eye, skin, or may be inhaled. Workers using eyewash stations after exposure to a hazardous chemical or material may have eye injuries that make the eye more susceptible to infection. Also, workers with skin damage or compromised immune systems (e.g., transplant recovery, cancer, lupus) are at increased risk for developing illnesses from contaminated water. Early diagnosis is important to prevent infections from causing serious health effects, including permanent vision loss and severe lung diseases (e.g., pneumonia).

The following are a few organisms that thrive in eyewash stations when not maintained properly and the health hazards they present. This list is not all inclusive. There are many other microorganisms that live in stagnant water that are not listed below.

***Acanthamoeba*** is a microscopic single cell organism (amoeba) that may cause eye infections (see Figure 1). This organism can live in treated water and is commonly found in mucous membranes (e.g., nose, throat, eyes) and in neurological tissues (e.g., brain) without causing harm to the person. On rare occasions, exposure to *Acanthamoeba* results in harmful eye infections known as *Acanthamoeba keratitis*. Along with keratitis, workers with compromised immune systems face a significantly higher risk for developing neurological infections (Granulomatous Amoebic Encephalitis)

or whole body infections. Workers may also experience eye redness, pain, tearing, blurred vision, light sensitivity, and eye inflammation several days after the use of a contaminated eyewash station. Diagnosing *Acanthamoeba* keratitis is difficult because more common eye infections have similar symptoms.



**Figure 1.** Left, broad illumination; right, slit beam illumination. Early epithelial stage. Multifocal intraepithelial *Acanthamoeba* organisms.

Photo courtesy of Dan B. Jones, M.D.

***Pseudomonas*** infections are typically caused by a common bacteria species. *Pseudomonas aeruginosa* may cause infections to eyes, skin, muscle, lung, and other tissues. One symptom specific to *Pseudomonas aeruginosa* infection is green-blue pus in or around the infected area. If a pseudomonas infection spreads through the bloodstream (*i.e.*, septicemia), workers may become very sick with fevers, chills, confusion, shock, and even death. This bacterium has developed resistance to many antibiotics, which may make it harder to treat.



**Figure 2.** Eyewash with protective covers.

***Legionella*** is a group of bacteria that are found in nature living with amoeba and may cause a serious lung infection.

For example, since *Acanthamoeba* are effective hosts for *Legionella*, they may both be present in contaminated water. Although *Legionella* does not cause eye infections, inhaling water droplets containing the bacteria can cause Legionnaires' disease, a severe and fatal form of pneumonia. Workers with compromised immune systems, workers over the age of 55 or those with pre-existing lung diseases, such as Chronic Obstructive Pulmonary Diseases (COPD) are more at risk for infection. Legionnaires' disease symptoms occur 2 to 14 days after exposure, including coughing, breathlessness, high fever, muscle aches, and headaches, often requiring hospitalization.

For more information on Legionnaires' disease visit the OSHA Safety and Health Topics Page ([www.osha.gov/SLTC/legionnairesdisease](http://www.osha.gov/SLTC/legionnairesdisease)).

### How can eyewash stations be maintained to prevent infections?

Eyewash station manufacturer instructions provide direction on how often and how long to activate specific plumbed systems to reduce microbial contamination and generally reference the American National Standards Institute (ANSI) standard Z358.1-2014. Self-contained eyewash units must be maintained and employers should consult the manufacturer's instructions for maintenance procedures. This includes flushing the system and using only solutions appropriate for flushing eyes.

### Workers' Rights

Workers have the right to:

- Working conditions that do not pose a risk of serious harm.
- Receive information and training (in a language and vocabulary the worker understands) about workplace hazards, methods to prevent them, and the OSHA standards that apply to their workplace.
- Review records of work-related injuries and illnesses.
- File a complaint asking OSHA to inspect their workplace if they believe there is a serious hazard or that their employer is not following OSHA's rules. OSHA will keep all identities confidential.
- Exercise their rights under the law without retaliation, including reporting an injury or raising health and safety concerns with their employer or OSHA. If a worker has been retaliated against for using their rights, they must file a complaint with OSHA as soon as possible, but no later than 30 days.

For additional information on Workers' Rights, Employer Responsibilities, and other services OSHA offers, visit [www.osha.gov](http://www.osha.gov).

### Contact OSHA

For questions or to get information or advice, to report an emergency, fatality, inpatient hospitalization, amputation, or loss of an eye, or to file a confidential complaint, contact your nearest OSHA office, visit [www.osha.gov](http://www.osha.gov), or call OSHA at 1-800-321-OSHA (6742), TTY 1-877-889-5627.

OSHA's On-site Consultation Program offers free and confidential advice to small and medium-sized businesses in all states across the country, with priority given to high-hazard worksites. On-site consultation services are separate from enforcement and do not result in penalties or citations.

For more information, to find the local On-site Consultation office in your state, or to request a brochure on Consultation Services, visit [www.osha.gov/consultation](http://www.osha.gov/consultation), or call 1-800-321- OSHA (6742).

Many states operate their own OSHA-approved safety and health program. For further information, please visit [www.osha.gov/dcsp/osp](http://www.osha.gov/dcsp/osp).

## References

### **Pathogens found in eyewash stations:**

Paszko-Kolva C et al. Isolation of *amoebae* and *Pseudomonas* and *Legionella* spp. from eyewash stations. *Applied and Environmental Microbiology*. 1991;57(1):163–167. [PMC free article] [PubMed]

### ***Acanthamoeba* and *Acanthamoeba Keratitis* (AK):**

Crum-Cianflone NF. *Acanthamoeba* (updated 7/25/2013) <http://emedicine.medscape.com/article/211214-overview#a0199>

Marciano-Cabral F, Cabral GA. *Acanthamoeba* spp. as agents of disease in humans. *Clin Microbiol Rev*. 2003;16:273–307. [PMC free article] [PubMed]

### **Contact lens statistics on *Acanthamoeba Keratitis* (AK):**

Ibrahim YW, Boase DL, Cree IA. How Could Contact Lens Wearers Be at Risk of *Acanthamoeba* Infection? A Review. *J Optom*. 2009;02:60-66. <http://www.journalofoptometry.org/en/how-could-contact-lens-wearers/articulo/13188766>Page MA, Mathers WD. *Acanthamoeba Keratitis*: A 12-Year Experience Covering a Wide Spectrum of Presentations, Diagnoses, and Outcomes. *Journal of Ophthalmology*. <http://www.hindawi.com/journals/joph/2013/670242>

### **Estimated rates of AK:**

Estimated Burden of Keratitis — United States, 2010 November 14, 2014 / 63(45);1027-1030 <http://www.cdc.gov/mmwr/preview/mmwrhtml/mm6345a3.htm>

National Outbreak of *Acanthamoeba Keratitis* Associated with Use of a Contact Lens Solution, United States. [PDF, 663 KB, 7 pages] (Vol. 15, No. 8 / August 15, 2009)

Amebic Keratitis article (updated 7/23/2015) <http://emedicine.medscape.com/article/211214-overview#a0199>

### **Outbreaks of AK:**

CDC. *Acanthamoeba* keratitis (AK) outbreak investigation [http://www.cdc.gov/parasites/acanthamoeba/outbreaks/2011/outbreak\\_qa\\_ak.html](http://www.cdc.gov/parasites/acanthamoeba/outbreaks/2011/outbreak_qa_ak.html)

Outbreak following flooding in Iowa. <http://archophth.jamanetwork.com/article.aspx?articleid=263287>

This InfoSheet is not a standard or regulation, and it creates no new legal obligations. It contains recommendations as well as descriptions of mandatory safety and health standards. The recommendations are advisory in nature, informational in content, and are intended to assist employers in providing a safe and healthful workplace. The *Occupational Safety and Health Act* requires employers to comply with safety and health standards and regulations promulgated by OSHA or by a state with an OSHA-approved state plan. In addition, the Act's General Duty Clause, Section 5(a)(1), requires employers to provide their employees with a workplace free from recognized hazards likely to cause death or serious physical harm.





# OSHA<sup>®</sup> FactSheet

## Laboratory Safety Chemical Hygiene Plan (CHP)

OSHA's Occupational Exposure to Hazardous Chemicals in Laboratories standard (29 CFR 1910.1450), referred to as the Laboratory standard, specifies the mandatory requirements of a Chemical Hygiene Plan (CHP) to protect laboratory workers from harm due to hazardous chemicals. The CHP is a written program stating the policies, procedures and responsibilities that protect workers from the health hazards associated with the hazardous chemicals used in that particular workplace.

### Required CHP Elements

1. Standard operating procedures relevant to safety and health considerations for each activity involving the use of hazardous chemicals.
2. Criteria that the employer will use to determine and implement control measures to reduce exposure to hazardous materials [i.e., engineering controls, the use of personal protective equipment (PPE), and hygiene practices] with particular attention given to selecting control measures for extremely hazardous materials.
3. A requirement to ensure that fume hoods and other protective equipment are functioning properly and identify the specific measures the employer will take to ensure proper and adequate performance of such equipment.
4. Information to be provided to lab personnel working with hazardous substances include:
  - The contents of the Laboratory standard and its appendices.
  - The location and availability of the employer's CHP.
  - The permissible exposure limits (PELs) for OSHA regulated substances or recommended exposure limits for other hazardous chemicals where there is no applicable OSHA standard.
  - The signs and symptoms associated with exposures to hazardous chemicals used in the laboratory.
  - The location and availability of known reference materials on the hazards, safe handling, storage and disposal of hazardous chemicals found in the laboratory including, but not limited to, the Material Safety Data Sheets received from the chemical supplier.
5. The circumstances under which a particular laboratory operation, procedure or activity requires prior approval from the employer or the employer's designee before being implemented.
6. Designation of personnel responsible for implementing the CHP, including the assignment of a Chemical Hygiene Officer and, if appropriate, establishment of a Chemical Hygiene Committee.
7. Provisions for additional worker protection for work with particularly hazardous substances. These include "select carcinogens," reproductive toxins and substances that have a high degree of acute toxicity. Specific consideration must be given to the following provisions and shall be included where appropriate:
  - Establishment of a designated area.
  - Use of containment devices such as fume hoods or glove boxes.
  - Procedures for safe removal of contaminated waste.
  - Decontamination procedures.
8. The employer must review and evaluate the effectiveness of the CHP at least annually and update it as necessary.

### Worker Training Must Include:

- Methods and observations that may be used to detect the presence or release of a hazardous chemical (such as monitoring conducted by the employer, continuous monitoring devices, visual appearance or odor of hazardous chemicals when being released, etc.).
- The physical and health hazards of chemicals in the work area.

- The measures workers can take to protect themselves from these hazards, including specific procedures the employer has implemented to protect workers from exposure to hazardous chemicals, such as appropriate work practices, emergency procedures, and personal protective equipment to be used.
- The applicable details of the employer's written CHP.

### Medical Exams and Consultation

The employer must provide all personnel who work with hazardous chemicals an opportunity to receive medical attention, including any follow-up examinations which the examining physician determines to be necessary, under the following circumstances:

- Whenever a worker develops signs or symptoms associated with a hazardous chemical to which the worker may have been exposed in the laboratory, the worker must be provided an opportunity to receive an appropriate medical examination.
- Where exposure monitoring reveals an exposure level routinely above the action level (or in the absence of an action level, the PEL) for an

OSHA regulated substance for which there are exposure monitoring and medical surveillance requirements, medical surveillance must be established for the affected worker(s) as prescribed by the particular standard.

- Whenever an event takes place in the work area such as a spill, leak, explosion or other occurrence resulting in the likelihood of a hazardous exposure, the affected worker(s) must be provided an opportunity for a medical consultation to determine the need for a medical examination.
- All medical examinations and consultations must be performed by or under the direct supervision of a licensed physician and be provided without cost to the worker, without loss of pay and at a reasonable time and place.

#### For additional information on developing a CHP, consult the following sources:

- View the complete standard at the OSHA Web site, [www.osha.gov](http://www.osha.gov).
- Appendix A of 29 CFR 1910.1450 provides non-mandatory recommendations to assist in developing a CHP.

**This is one in a series of informational fact sheets highlighting OSHA programs, policies or standards. It does not impose any new compliance requirements. For a comprehensive list of compliance requirements of OSHA standards or regulations, refer to Title 29 of the Code of Federal Regulations. This information will be made available to sensory-impaired individuals upon request. The voice phone is (202) 693-1999; the teletypewriter (TTY) number is (877) 889-5627.**

For assistance, contact us. We can help. It's confidential.



OSHA FS-3461 8/2011  
DSG

## OSHA's Change Over to the Globally Harmonized System (GHS) of Classification, Labeling of Chemicals, and SDS



1

## Compliance Dates

### Effective Dates

The table below summarizes the phase-in dates required under the revised Hazard Communication Standard (HCS):

Effective Completion Date	Requirement(s)	Who
December 1, 2013	Train employees on the new label elements and safety data sheet (SDS) format.	Employers
June 1, 2015*	Compliance with all modified provisions of this final rule, except:	Chemical manufacturers, importers, distributors and employers
December 1, 2015	The Distributor shall not ship containers labeled by the chemical manufacturer or importer unless it is a GHS label	
June 1, 2016	Update alternative workplace labeling and hazard communication program as necessary, and provide additional employee training for newly identified physical or health hazards.	Employers
Transition Period to the effective completion dates noted above	May comply with either 29 CFR 1910.1200 (the final standard), or the current standard, or both	Chemical manufacturers, importers, distributors, and employers

2

## Training

- Why?
  - Some suppliers/distributors are already using the new Safety Data Sheet format and labels
  - To ensure all employees are able to interpret the new labels and Safety Data Sheets
  - Unique to each facility and is provided by the **employer**
- Who?
  - Essentially any employee *potentially exposed* to chemicals as part of their routine job. That means everyone.
    - e.g. an employee occasionally picking up a bottle of Windex to wipe down a door would not need training; however, an employee who uses Windex regularly would

3

## WHAT IS A HAZARDOUS CHEMICAL UNDER GHS?

### Hazard Classification

4

## Hazardous Chemical

- A chemical is defined as hazardous when it is classified as one of the following:
  - Health hazard
  - Physical hazard
  - Simple asphyxiant
  - Combustible dust
  - Pyrophoric gas
  - Hazard not otherwise classified

5

## Health Hazard Classification

- A chemical is classified as a health hazard if it poses one of the following effects:
  - Acute oral toxicity (any route)
  - Skin corrosion or irritation
  - Serious eye damage or eye irritation
  - Respiratory or skin sensitization
  - Germ cell mutagenicity
  - Carcinogenicity
  - Reproductive toxicity
  - Specific target organ toxicity
  - Aspiration hazard

6



## Physical Hazard Classification

- A chemical that poses one of the following hazardous effects:
  - Explosive
  - Flammable
  - Oxidizer
  - Self-reactive
  - Pyrophoric
  - Self-heating
  - Organic peroxide
  - Corrosive to metal
  - Gas under pressure
  - In contact with water emits flammable gas

7

## Simple Asphyxiant Classification

- A chemical is classified as such if it displaces oxygen in the ambient atmosphere and can cause oxygen deprivation leading to unconsciousness and death
- For example:
  - Nitrogen
  - Carbon dioxide
  - Hydrogen
  - Methane

8

## Combustible Dust

- NFPA 654 (2006) and NEP Definitions
  - **Combustible Dust** A combustible particulate solid that presents a fire or deflagration hazard when suspended in air or some other oxidizing medium over a range of concentrations, regardless of particle size or shape
  - **Combustible Particulate Solid** Any combustible solid material, composed of distinct particles or pieces, regardless of size, shape or chemical composition
- NFPA 69 (2002), and 499 (2004) Definitions
  - **Combustible Dust.** Any finely divided solid material 420 microns\* or less in diameter (i.e., material passing through a U.S. No 40 Standard Sieve) that presents a fire or explosion hazard when dispersed

9

## Combustible Dusts

<b>Agricultural Products</b> Egg white Milk, powdered Milk, nonfat, dry Soy flour Starch, corn Starch, rice Starch, wheat Sugar Sugar, milk Sugar, beet Tapioca Whey Wood flour	Cottonseed Garlic powder Gluten Grass dust Green coffee Hops (malted) Lemon peel dust Lemon pulp Linsaeed Locust bean gum Malt Oat flour Oat grain dust Olive pellets Onion powder Parsley (dehydrated) Peach Peanut meal and skins Peat Potato Potato flour Potato starch Raw yucca seed dust Rice dust Rice flour Rice starch Rye flour Semolina	Soybean dust Spice dust Spice powder Sugar (100) Sunflower Sunflower seed dust Tea Tobacco blend Tomato Walnut dust Wheat flour Wheat grain dust Wheat starch Xanthan gum	<b>Chemical Dusts</b> Adipic acid Anthraquinone Ascorbic acid Calcium acetate Calcium stearate Carbonyl-methylcellulose Dextrin Lactose Leaet stearate Methyl-cellulose Parafomaldehyde Sodium ascorbate Sodium stearate Sulfur	<b>Carbonaceous Dusts</b> Charcoal, activated Charcoal, wood Coal, bituminous Coke, petroleum Lampblack Lignite Peat, 22%+H <sub>2</sub> O Soot, pine Cellulose Cellulose pulp Cork Corn	<b>Metal Dusts</b> Aluminum Bronze Iron carbonyl Magnesium Zinc	<b>Plastic Dusts</b> (poly) Acrylamide (poly) Acrylonitrile (poly) Ethylene (low-pressure process)	Epoxy resin Melamine resin Melamine, molded (phenol-cellulose) Melamine, molded (wood flour and mineral filled phenol-formaldehyde) (poly) Methyl acrylate (poly) Methyl acrylate, emulsion polymer Phenolic resin (poly) Propylene Terpeno-phenol resin Urea-formaldehyde/cellulose, molded (poly) Vinyl acetate/ethylene copolymer (poly) Vinyl alcohol (poly) Vinyl butyral (poly) Vinyl chloride/ethylene/vinyl acetate suspension copolymer (poly) Vinyl chloride/vinyl acrylate emulsion copolymer
--	---	--	---	--	--	---	---

10

## Pyrophoric Gas Classification

- A chemical in a gaseous state that will ignite spontaneously in air at a temperature of 130°F
- For example:
  - Arsine
  - Silane
  - Metal carbonyls (dicobalt octacarbonyl, nickel carbonyl)
  - Diborane

11

## Hazard Not Otherwise Classified Classification

- A chemical is classified as such when there is an adverse physical or health effect identified through evaluation of scientific evidence that does not meet the specified criteria for the physical and health hazard classes
- Not required on the label, but should be on the SDS
- Does not apply to adverse physical and health hazards under a GHS category that was not adopted by OSHA, such as acute toxicity Category 5

12



## Signal Word

- Used to indicate the relative level of severity of hazard and alert the reader to a potential hazard
- One, but not both, of the following
  - Danger**—more severe hazard
  - Warning**—less severe hazard



19

## Hazard Statement

- Assigned to a hazard class and hazard category and describes the nature of the hazard
- Examples
  - Fatal if swallowed
  - May cause damage to *kidneys* through prolonged or repeated exposure
  - May cause or intensify fire
  - Extremely flammable liquid or vapor
  - Heating may cause an explosion

20

## Hazard Statement

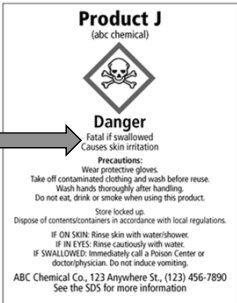

21

## Precautionary Statements

- A phrase that describes recommended measures that should be taken to minimize or prevent adverse effects resulting from exposure or improper storage or handling
- Prevention
- Response
- Storage
- Disposal
- They can be combined or consolidated to save space on the label

22

## Precautionary Statement

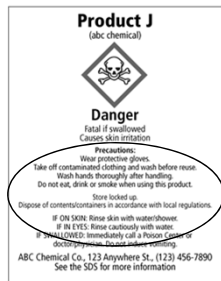

23

## Pictograms

- Nine are designated by GHS
- Eight are adopted by OSHA
- No duplicates or blank diamonds allowed on the label
- Correct name for the diamond is “squares-on-point”



24

### Pictogram

Red frame

Black hazard symbol

White background

25

### Health Hazard

- Carcinogen
- Mutagenicity
- Reproductive Toxicity
- Respiratory Sensitizer
- Target Organ Toxicity
- Aspiration Toxicity

26

### Skull and Crossbones

- Acute Toxicity

27

### Flame

- Flammables
- Pyrophorics
- Self-Heating
- Emits Flammable Gas
- Self Reactives
- Organic Peroxides

28

### Flame Over Circle

- Oxidizers

29

### Corrosion

- Skin Corrosion/Burns
- Eye Damage
- Corrosive to Metals

30

### Gas Cylinder

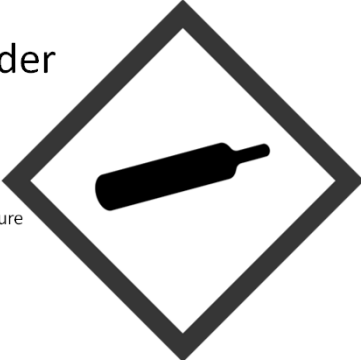

- Gases Under Pressure

31

### Exploding Bomb



- Explosives
- Self-Reactives
- Organic Peroxides

32

### Exclamation Mark

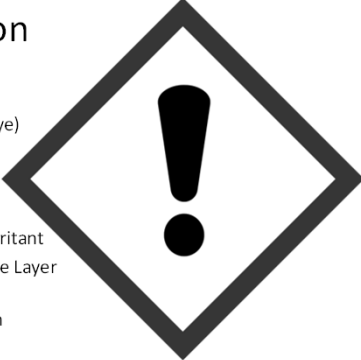

- Irritant (skin and eye)
- Skin Sensitizer
- Acute Toxicity-low
- Narcotic Effects
- Respiratory Tract Irritant
- Hazardous to Ozone Layer (-non-mandatory)
- (Low degree health hazard)

33

### Environmental (non-mandatory)

OSHA Does Not Enforce This One



- Aquatic Toxicity

34

### HCS Pictogram & Hazards

<ul style="list-style-type: none"> <li>• Carcinogen</li> <li>• Mutagenicity</li> <li>• Reproductive Toxicity</li> <li>• Respiratory Sensitizer</li> <li>• Target Organ Toxicity</li> <li>• Aspiration Toxicity</li> </ul>	<b>Flame</b> <ul style="list-style-type: none"> <li>• Flammables</li> <li>• Self-Heating</li> <li>• Oxidizing</li> <li>• Organic Peroxides</li> </ul>	<b>Exclamation Mark</b> <ul style="list-style-type: none"> <li>• Irritant (skin and eye)</li> <li>• Skin Sensitizer</li> <li>• Acute Toxicity</li> <li>• Narcotic Effects</li> <li>• Respiratory Tract Irritant</li> <li>• Hazardous to Ozone Layer (-non-mandatory)</li> <li>• (Low degree health hazard)</li> </ul>
<ul style="list-style-type: none"> <li>• Gases Under Pressure</li> </ul>	<ul style="list-style-type: none"> <li>• Corrosive to Metals</li> </ul>	<ul style="list-style-type: none"> <li>• Self-Reactives</li> <li>• Organic Peroxides</li> </ul>
<b>Flame Over Circle</b> <ul style="list-style-type: none"> <li>• Oxidizers</li> </ul>	<b>Environment (non-mandatory)</b> <ul style="list-style-type: none"> <li>• Aquatic Toxicity</li> <li>• OSHA Does Not Enforce This One</li> </ul>	<b>Skull and Crossbones</b> <ul style="list-style-type: none"> <li>• Acute Toxicity (fatal or toxic)</li> </ul>

### Pictogram

HCS Pictograms and Hazards

<b>Health Hazard</b> <ul style="list-style-type: none"> <li>• Carcinogen</li> <li>• Mutagenicity</li> <li>• Reproductive Toxicity</li> <li>• Respiratory Sensitizer</li> <li>• Target Organ Toxicity</li> <li>• Aspiration Toxicity</li> </ul>	<b>Flame</b> <ul style="list-style-type: none"> <li>• Flammables</li> <li>• Pyrophorics</li> <li>• Self-Heating</li> <li>• Emits Flammable Gas</li> <li>• Self-Reactives</li> <li>• Organic Peroxides</li> </ul>	<b>Exclamation Mark</b> <ul style="list-style-type: none"> <li>• Irritant (skin and eye)</li> <li>• Skin Sensitizer</li> <li>• Acute Toxicity</li> <li>• Narcotic Effects</li> <li>• Respiratory Tract Irritant</li> <li>• Hazardous to Ozone Layer (-non-mandatory)</li> <li>• (Low degree health hazard)</li> </ul>
<b>Gas Cylinder</b> <ul style="list-style-type: none"> <li>• Gases Under Pressure</li> </ul>	<b>Corrosion</b> <ul style="list-style-type: none"> <li>• Skin Corrosion/Burns</li> <li>• Eye Damage</li> <li>• Corrosive to Metals</li> </ul>	<b>Exploding Bomb</b> <ul style="list-style-type: none"> <li>• Explosives</li> <li>• Self-Reactives</li> <li>• Organic Peroxides</li> </ul>
<b>Flame Over Circle</b> <ul style="list-style-type: none"> <li>• Oxidizers</li> </ul>	<b>Environment (non-mandatory)</b> <ul style="list-style-type: none"> <li>• Aquatic Toxicity</li> <li>• OSHA Does Not Enforce This One</li> </ul>	<b>Skull and Crossbones</b> <ul style="list-style-type: none"> <li>• Acute Toxicity (fatal or toxic)</li> </ul>

36

## Workplace Labels

### (Transfer containers)

- The employer shall ensure that each container is labeled with either
  - Product identifier
  - Signal word
  - Hazard statement(s)
  - Pictogram
 Or
  - Product identifier and
  - Adequate information about the hazards
  - Employers must comply by June 1, 2016

37

## Transfer Container Labeling Exemption Continues

### • Portable containers

- Identity and hazard information (or product identifier, signal word, hazard statement, signal word, pictogram) must be transferred unless the portable container is:
  - Under the control at all times of the employee making the transfer from the labeled container and
  - Contents used up in one shift

Employers must comply by June 1, 2016

38

## Alternative Labeling



- Permitted when employer's overall program proven effective
- Must ensure employees fully aware of hazards/use and understanding of labeling system
- Employer bears burden of establishing that employee awareness equals or exceeds conventional labeling system

39

## Workplace Labeling

- Can HMIS or NFPA system be used?
- While, the hazard category does not appear on the label, consider

GHS		HMIS/NFPA	
Category	Hazard	Category	Hazard
1	highest	1	slight
2	high	2	moderate
3	medium	3	serious
4	low	4	severe

→

NFPA categories were intended for emergency response, not workplace hazards; only considers acute effects, does not consider chronic effects

40

## Labeling Effective Dates

- Chemical manufacturers, importers, and employers
  - Will not ship containers without GHS labeling/SDS by June 1, 2015
- Employers
  - By June 1, 2016
    - Update alternative workplace labeling and hazard communication program as necessary, and provide additional employee training for newly identified physical or health hazards.

41

## SAFETY DATA SHEETS (SDS)

42

## Safety Data Sheet Info

- In English
- New 16-section format
- Compliance date for chemical manufactures, imports and distributors —June 1, 2015
- **Example pH 7 below**

43

## Safety Data Sheet Sections

- Section 1 Identification
  - Section 2 Hazard(s) identification
  - Section 3 Composition/information on ingredients
  - Section 4 First-aid measures
  - Section 5 Fire-fighting measures
  - Section 6 Accidental release measures
  - Section 7 Handling and storage
  - Section 8 Exposure controls/personal protection
  - Section 9 Physical and chemical properties
  - Section 10 Stability and reactivity
  - Section 11 Toxicological information
  - Section 12 Ecological information
  - Section 13 Disposal considerations
  - Section 14 Transport information
  - Section 15 Regulatory information
  - Section 16 Other information, including date of preparation or last revision
- Information in these sections will not be enforced by OSHA

44

## Section 1

### Section 1 – Chemical Product and Company Identification

Catalog Numbers: 40475  
Product Identity: Buffer Soln. pH 7.00

Manufacturer's Name: AquaPhoenix Scientific, Inc., 9 Barnhart Dr., Hanover, PA 17331  
Emergency Contact Number (24hr): InfoTrac (800) 535-5053

### Identification Of The Substrate Or Mixture And Of The Supplier

- GHS product identifier
- Other means of identification
- Recommended use of the chemical and restrictions on use
- Supplier's details
  - Name, address, phone #
- Emergency phone number

45

## Section 2

### Section 2 – Composition, Information on Ingredients

Sodium Phosphate, Dibasic, CAS# 7558-79-4, <3% w/v, ACGIH TLV: NA, OSHA PEL: NA  
Potassium Phosphate, Monobasic, CAS# 7778-77-0, <2% w/v, ACGIH TLV: NA, OSHA PEL: NA  
Water, purified, CAS# 7732-18-5, >95% w/v, ACGIH TLV: NA, OSHA PEL: NA

### Hazards Identification

- GHS classification of the substance/mixture and any national or regional information
- GHS Label elements, including precautionary statements
  - Hazard symbols may be provided as a graphical reproduction of the symbols in black and white or the name of the symbol,
    - e.g. flame, skull and crossbones
- Other hazards which do not result in classification or are not covered by the GHS

46

## Section 3

### Section 3 – Hazard Identification

Emergency Overview: Non-flammable, non-corrosive, non-toxic. Does not present significant health hazards. Wash areas of contact with water.

Target Organs: Eyes, skin.

Potential Health Effects

Eyes: May cause slight irritation.

Skin: May cause slight irritation.

Ingestion: Large doses may cause upset stomach

Inhalation: Not likely to be a hazard

Chronic Effect / Carcinogenicity: None (IARC, NTP, OSHA)

### Composition/Information Ingredients

- Substance
  - Chemical identity
  - Common name, synonyms, etc.
  - CAS number, EC number, etc.
  - Impurities and stabilizing additives which are themselves classified and which contribute to the classification of the substance
- Mixture
  - The chemical identity and concentration or concentration ranges of all ingredients which are hazardous within the meaning of the GHS and are present above their cutoff levels

47

## Section 4

### Section 4 – First Aid

Eyes: Immediately flush eyes with water for at least 15 minutes. Immediately get medical assistance.

Skin: Flush with water for 15 minutes. Get medical assistance if irritation develops.

Ingestion: Dilute with water or milk. Get medical assistance.

Inhalation: Remove to fresh air. Give artificial respiration if necessary. If breathing is difficult, give oxygen.

### First Aid Measures

- Description of necessary measures, subdivided according to the different routes of exposure
  - i.e. inhalation, skin and eye contact, and ingestion
- Most important symptoms/effects, acute and delayed
- Indication of immediate medical attention and special treatment needed, if necessary

48

## Section 5

### Section 5 – Fire Fighting Measures

Flash Point: NA

Extinguishing Media: Use means suitable to extinguishing surrounding fire.

Fire & Explosion Hazards: Not considered to be a fire or explosion hazard.

Fire Fighting Instructions / Equipment: Use normal procedures. Poisonous gases may be produced in fire. Use protective clothing. Use NIOSH-approved breathing equipment.

NFPA Rating: (estimated) Health: 1; Flammable: 0; Reactivity: 0

### Firefighting Measures

- Suitable (and unsuitable) extinguishing media
- Specific hazards arising from the chemical
  - e.g. nature of any hazardous combustion products
- Special protective equipment and precautions for firefighters

49

## Section 6

### Section 6 – Accidental Release Measures

Absorb with suitable material. Always obey local regulations.

### Accidental Release Measures

- Personal precautions, protective equipment and emergency procedures
- Environmental precautions
- Methods and materials for containment and cleaning up

50

## Section 7

### Section 7 – Handling and Storage

Handling: Wash hands after handling. Avoid contact with skin and eyes.

Storage: Protect from freezing and physical damage.

### Handling and Storage

- Precautions for safe handling
- Conditions for safe storage, including any incompatibilities

51

## Section 8

### Section 8 – Exposure Controls, Personal Protection

Engineering Controls: Normal ventilation is adequate.

Page 1 of 2 40475

Respiratory Controls: Normal ventilation is adequate.

Skin Protection: Chemical resistant gloves.

Eye Protection: Safety Glasses or goggles.

### Exposure Controls/Personal Protection

- Control parameters
  - e.g. occupational exposure limit values or biological limit values
- Appropriate engineering controls
- Individual protection measures, such as PPE

52

## Section 9

### Section 9 – Physical and Chemical Properties

Appearance: Clear, yellow liquid

pH: 5.8-8

Boiling Point: Approx 100C

Melting Point: Approx 0 C

Odor: Odorless

Solubility in Water: Infinite

Specific Gravity: Approx 1

Vapor Pressure: NA

### Physical and Chemical Properties

- Appearance
- Odor
- Odor threshold
- pH
- Melting point/freezing point
- Initial boiling point and boiling range
- Flash point
- Flammability
- Upper/lower flammability or explosive limits
- Vapor pressure
- Vapor density
- Relative density
- Solubility(ies)
- Partition coefficient
- Autoignition temperature
- Decomposition temperature

53

## Section 10

### Section 10 – Stability and Reactivity

Chemical Stability: Stable under normal conditions of use and storage.

Incompatibility: None Identified.

Hazardous Decomposition Products: Oxides of Phosphorus

Hazardous Polymerization: Does not occur

### Stability and Reactivity

- Chemical stability
- Possibility of hazardous reactions
- Conditions to avoid
  - e.g. static discharge, shock or vibration
- Incompatible materials
- Hazardous decomposition products

54



## Section 11

### Section 11 – Toxicological Information

LD50 orl-rat: 17 g/kg (Sodium Phosphate, Dibasic)  
LC50 inhalation-rat: >4640 mg/kg (Potassium Phosphate, Monobasic)

#### Toxicological Information

- Concise but complete comprehensible description of the various toxicological (health) effects and the available data used to identify those effects
- Includes:
  - Information on the like routes of exposure
  - Symptoms related to the physical, chemical and toxicological characteristics
  - Delayed and immediate effects and also chronic effects from short and long term exposures
  - Numerical measures of toxicity
    - LD – Lethal does; amount ingested that kills 50% of test sample.

55

## Section 12

Information in this section will not be enforced by OSHA

### Section 12 – Ecological Information

Ecotoxicity: NA

#### Ecological Information

- Eco-toxicity
- Persistence and degradability
- Bio-accumulative potential
- Mobility in soil
- Other adverse effects

56

## Section 13

Information in this section will not be enforced by OSHA

### Section 13 – Disposal Considerations

Dilute with water.

All chemical waster generators must determine whether a discarded chemical is classified as hazardous waste.

Comply with all local, state, and federal regulations.

#### Disposal Considerations

- Description of waste residues and information on their safe handling and methods of disposal
  - Including the disposal of any contaminated packaging

57

## Section 14

Information in this section will not be enforced by OSHA

### Section 14 – Transport Information

#### Transport Information

DOT - Not Regulated

- UN number
- UN proper shipping name
- Transport hazard class(es)
- Packing group, if applicable
- Marine pollutant (yes/no)
- Special precautions which a user needs to be aware of or needs to comply with in connection with transport or conveyance either within or outside their premises

58

## Section 15

Information in this section will not be enforced by OSHA

### Regulatory Information

- Safety, health and environmental regulations specific for the product in question

#### Section 15 – Regulatory Information (not meant to be all inclusive)

OSHA Status: These chemicals are not considered hazardous by OSHA.  
TSCA: The components of this solution are listed on the TSCA Inventory  
SARA Title III Section 313: Not Applicable  
RCRA Status: NA  
CERCLA Reportable Quantity: Sodium Phosphate, Dibasic – 5,000 lbs.  
WHMIS: NA

59

## Section 16

### Other Information Including Information on Preparation and Revision of the SDS

#### Section 16 – Additional Information

Issue Date: 12/28/06  
Revision Date: 6/5/08, 11/19/09

60

## EFFECTS ON OTHER STANDARDS



29 CFR 1910  
OSHA General Industry  
Regulations

61

### Flammable Liquids

GHS FL Category	Flashpoint Deg F	Boiling Point Deg F	Old OSHA Class	Flashpoint Deg F	Boiling Point Deg F
1	<73.4	≤95	IA	<73	<100
2	<73.4	<95	IB	<73	≥100
3	≥73.4 and ≤140		IC II	≥73 and <100 ≥100 and <140	
4	>140 and ≤199.4		IIIA	≥140 and <200	
None			IIIB	>200	62

**WHAT-TO-DO BOOKLET**  
A Template for Compliance With  
(29 CFR 1910.1200 and 29 CFR 1926.59)  
Hazard Communication Standard  
And  
(0800-1-1-09)  
The Tennessee Hazardous Chemical Right-To-Know Law



**GHS** **GHS**

Revised November, 2012

63

## Resources



Centers for Disease Control and Prevention  
CDC 24/7: Saving Lives. Protecting People™

- CDC works 24/7 to protect America from health, safety and security threats, both foreign and in the U.S. Whether diseases start at home or abroad, are chronic or acute, curable or preventable, human error or deliberate attack, CDC fights disease and supports communities and citizens to do the same. [www.cdc.gov](http://www.cdc.gov)

64

## Resources

- **OSHA ([www.osha.gov](http://www.osha.gov))**
  - "No one should have to sacrifice their life for their livelihood, because a nation built on the dignity of work must provide safe working conditions for its people."  
-Secretary of Labor Thomas E. Perez
  - Under federal law, you are entitled to a safe workplace. Your employer must provide a workplace free of known health and safety hazards. If you have concerns, you have the right to speak up about them **without fear of retaliation**. You also have the right to:

65

TN Department of Environment and Conservation

- **OSHA ([www.osha.gov](http://www.osha.gov))**
  - Be trained in a language you understand
  - Work on machines that are safe
  - Be provided required safety gear, such as gloves or a harness and lifeline for falls
  - Be protected from toxic chemicals
  - Request an OSHA inspection, and speak to the inspector
  - Report an injury or illness, and get copies of your medical records
  - See copies of the workplace injury and illness log
  - Review records of work-related injuries and illnesses
  - Get copies of test results done to find hazards in the workplace

66

## Resources

- **TOSHA**

- Tennessee OSHA improves occupational safety and health through enforcement of the general industry, construction and agricultural occupational safety and health standards in workplaces. - See more at:

<https://www.tn.gov/workforce/section/tosha>

67

## Resources

- **TOSHA**

- TOSHA's mission is to assure the safety and health of Tennessee's working men and women
- by promulgating and enforcing standards and regulations; providing training, outreach, and education;
- establishing cooperative programs; and encouraging continual improvement in workplace safety and health
- as well as the development of comprehensive safety and health management systems. Effective and
- efficient use of resources requires careful, flexible planning. In this way, the overall goal of hazard
- abatement and employee protection is best served.

68

## Resources

- OSHA [www.osha.gov](http://www.osha.gov)

- CDC [www.cdc.gov](http://www.cdc.gov)

- **TOSHA**

<https://www.tn.gov/workforce/article/standards-and-rules>

- Memphis Office 901-543-7259
- Jackson Office 731-423-5641
- Nashville Office 615-741-2793  
1-800-249-8510
- Knoxville Office 865-594-6180
- Kingsport Office 423-224-2042
- Chattanooga 423-634-6424

69

## Laboratory Equipment

### Identification, Handling, and Cleaning



1

## Objectives

- Identify equipment commonly used in water treatment and wastewater laboratory
- Discuss accuracy and use of glassware
- Discuss how to use and maintain analytical equipment

2

## Beakers



Used for:

- Mixing
- Measuring approximate volumes
- ~10% accuracy

3

## Graduated Cylinders

- Accurate to ~1%
- Measures liquid volumes more accurately than beakers, but still not the most accurate
- Measure quicker

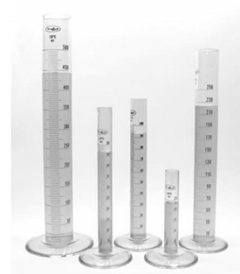

4

## Volumetric Flasks



- Most accurate way to measure volume
- Disadvantage:
  - Only can measure one volume
  - Not used for storing or heating solutions

5

## What Are Pipets?

- Pipets are glass or plastic tubes, usually open at both ends, which are used to transfer specific amounts of liquid from one container to another
- They are usually used for volumes between 1 and 100 milliliters

6

## Types of Pipets

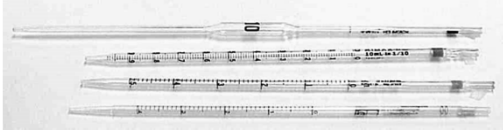

1. Volumetric
2. Measuring
  - Mohr
  - Serological

7

## Volumetric Pipets

- Used to deliver a single specific volume of liquid, usually between 1 and 100 ml
- Shaped like rolling pins with a large belly, one blunt end, the neck, and one tapering end, the tip



8

## Volumetric Pipets

- Used for accurate measurements, since it is designed to deliver only one volume and is calibrated at that volume
- Should be used when accuracy and reproducibility are crucial, because these can achieve accuracy to four significant figures

9

## Specifications on a Volumetric Pipet

- When emptying a volumetric pipet, the liquid is allowed to drain out
  - It is NOT forced out
- After it is emptied, the small amount of liquid which remains in the tip should not be blown out
- Volumetric pipets are NOT blow-out pipets

10

## Measuring Pipets

- They are straight glass or plastic tubes with one tapering end
- Calibrated into small divisions so that various amounts of liquid can be measured with the same pipet
- Usually used to measure any amount between 0.1ml and 25.0ml
- They are not as accurate due to the fact that any imperfection in their internal diameter will have a greater effect on the volume delivered

11

## Mohr and Serological Pipets

- Measuring pipets are divided into:

- Mohr Pipets
  - Graduations on these always end before the tip
- Serological Pipets
  - Graduation marks continue to the tip

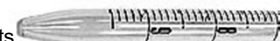
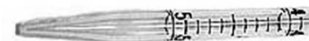

12

Examine pipets A and B  
Which is the serological and which is the Mohr?

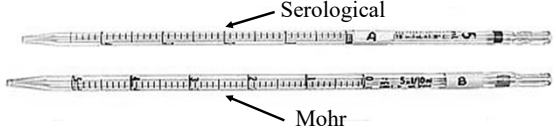

13

### Specifications on a Measuring Pipet



- Maximum volume of liquid that can be transferred
- Size of the divisions on the pipet
- Temperature at which calibrations were made
- If the pipet is a "to deliver"(TD) or "to contain"(TC) pipet

14

### 5 in 1/10 ml TD 20°C



- Specifications on a pipet as shown above indicate that the pipet is calibrated in 1/10ml divisions and will deliver up to 5.0 ml within published tolerance levels at 20°C

15

### 1 ml in 1/100 TD 20°C



- These specifications indicate that the pipet is calibrated in 1/100 ml divisions and it will deliver up to 1.00 ml within published tolerance levels at 20°C

16

### Using Pipets

- Select a clean, dry pipet of appropriate size
  - If clean/dry is not available, rinse several times with the solution to be used
- Avoid contaminating or diluting the solution by dipping a dirty or wet pipet into original solution
  - Pour some solution into a clean beaker, dip pipet into that beaker
  - Discard what remains in the beaker
  - Never put excess solution back into original reagent bottle

17

### Handling and Disposing of Pipets

- Chipped and cracked pipets should be replaced as they are unsafe and may affect the accuracy of measurements.
- NEVER mouth pipet
- Hold the pipet by the upper third of the tube and keep the tip from touching anything

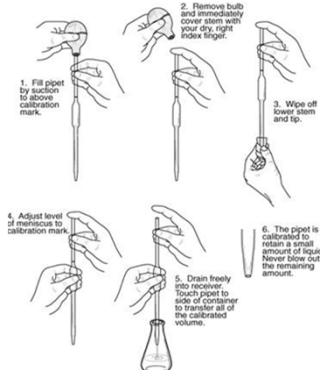

18

## Handling and Disposing of Pipets

- Dispose dirty pipets by placing in soapy water solution in a tray or pipet washer
- Place disposable pipets in a cardboard holder
- Do not leave pipets on counters or sinks



## Handling Sterile Pipets

- When using sterile pipets, be sure to use proper sanitary techniques
- If you have a sterile package of disposable pipets, tear only a small corner of the package open and push one pipet out of this opening, then immediately close the package to prevent contamination



## Handling Sterile Pipets

- If you are using sterile pipets in a pipet canister, place the canister on its side, slide off the cover, pull out one pipet and replace the cover immediately



## Transferring a Precise Volume of Liquid

- A pipet bulb is used to draw liquid up into the pipet
- There are many types of pipet bulbs



## Transferring a Precise Volume of Liquid

- You should observe the meniscus at eye-level
- Touch the tip of the pipet to the inside of the container when the meniscus is at the desired level

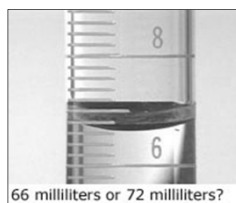

## Transferring a Precise Volume of Liquid

- Squeeze bulb and touch it to the mouth of the pipet
- Place other end of the pipet in liquid to be transferred and slowly release pressure on bulb
- Draw liquid up past desired level, quickly replacing bulb with index finger

## Transferring a Precise Volume of Liquid

- Let liquid drain until bottom of meniscus lines up with desired level on pipet
- Touch tip of pipet to inside of beaker to remove any adhering drops
- Transfer liquid to second beaker and touch tip to inside of beaker and let liquid drain out of pipet

25

## Other Pipet Bulbs

- Other pipet bulbs that are often used include the Vadosa pipet filler, seen on the left, and the pipet Pumper, on the right



26

## Other Pipet Types

- Transfer of uncalibrated volumes up to 2.5 ml can be accomplished using glass "transfer" or "Pasteur" pipets shown below. These may be sterilized before use
- Roughly calibrated volumes of 1 and 2 ml can be transferred with the one piece plastic transfer pipets which may be purchased as sterile or non-sterile units

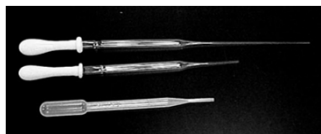

27

## Burettes and Titrations



### Burettes

- Used for titrations
- Treat like a Mohr pipet, do not let liquid completely drain out
- Also, make sure to remove air bubble in tip before titrating
  - Gently tap side with your finger to dislodge any bubbles clinging to walls

28

## Flasks

- Distilling Flask



- Florence (Flat Bottom) Flask



29

## Flasks

- Erlenmeyer Flasks
- Filter Flask



30



### How Scientific Glassware is made

- [Glass blowing video](#)
- [Machine made video](#)

31

### Filter Apparatus

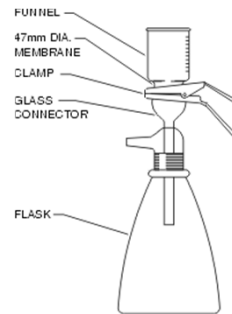

- Vacuum Pump



32

### Bottles

- Dilution Bottles
- Sample Bottles



33

### Bottles

- Reagent Bottles
- Weighing Bottles



34

### Funnels

- Separatory
- Buchner
- General



35

### Petri Dish/Dessicator

- Petri Dish
- Culturing container
- Desiccators
- Dust and moisture free



36

## Evaporating Dish/Crucible

- Evaporating Dish
- Crucible



37

## Centrifuge



- Used to separate materials of different density
- Weight must be evenly distributed
- Position test tubes across from each other to balance

38

## Autoclave

- Pressure cooker used to sterilize glassware, bottles, membrane filter equip, culture media and contaminated material to be discarded
- Standard temperature is set at 121°C and 15 PSI



39

## Refrigerators



Walk-in cooler



- Sample storage should maintain between 1-6 °C
- Never store samples and chemicals together

40

## Incubators

- Artificially heated container used for growing bacteria cultures
- Dry-Heat types hold temperatures to  $\pm 0.5^\circ\text{C}$
- For E. coli and Total coliform =  $35 \pm 0.5^\circ\text{C}$
- Water Bath for fecal =  $44.5 \pm 0.2^\circ\text{C}$



41

## Incubators



- For BOD incubation at  $20 \pm 1^\circ\text{C}$
- Do not store chemical solutions and samples in same refrigerator

42

## UV Sterilizer

- Use in Bacterial Lab to sterilize test equipment
- 3 minutes time



## Drying Oven



- Used more often in wastewater labs
- For solids testing set oven at 103-105°C

44

## Muffle Furnace

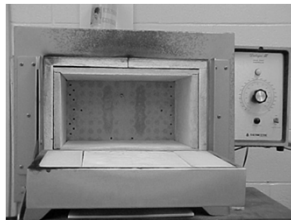

- High temp oven used to ignite or burn solids
- Usually operate at temps of 550°C
- More often used in Wastewater lab work
  - MLVSS

45

## Fume Hood

- Can prevent serious accidents
- Use whenever heat is used in a test procedure
- Fumes vented out of lab
- Use when harmful smoke, gas, vapors, splashes or fumes are possible



46

## Water Still



- Produces distilled water for lab tests and rinsing washed glassware
- Removes dissolved minerals, organic and inorganic nonvolatile compounds
- Does not sterilize

47

## Heating and Stirring Samples

- Combo Heat/Stir Plate
  - Can be used to stir or heat and stir samples
  - Safer than heating with an open flame
- Gas Burner
  - Bunsen burner
  - Uses natural



48

## Balances

- Top Loading
  - Weighs to the nearest 0.01 g
- Analytical
  - Precise to 0.0001 g



49

## pH Meter

- Use buffer solutions to calibrate
- Store electrodes properly
- Calibrate daily
- Maintain records on daily calibrations



50

## Spectrophotometer

- HACH DR 6000
  - Factory pre-set programs for lab chemical analysis
- Very versatile



51

## Colorimeters

- Determine the concentration of many chemicals
- Most commonly used is chlorine type colorimeter
- Portable and battery powered



52

## Amperometric Titrator

- Chlorine analysis
- Accurate and unaffected by sample color or turbidity
- Takes greater skill to use than DPD method with colorimetric devices



53

## Turbidimeter

- Desk top and continuous on-line monitoring
- Position away from direct sunlight and have extra light bulb on hand
- Ensure sample bottles maintained; no scratches; acid clean if necessary



54

## Chemical Storage

- Do not store volatile chemicals together
- Have separate storage cabinets for acids and bases/caustics



55

## Flammable Cabinet



Flammable chemicals should be kept in a flammable cabinet

56

## Safety Equipment



### PPE (Personal Protective Equipment):

- Goggles
- Gloves
- Aprons
- Wear safety clothing

57

## Eye Wash and Shower

- Should be checked weekly



58

## Cleaning Glassware

- Just because it looks clean does not mean residues are not left behind
- Results need to be accurate to use data for process control and/or reporting to the State
- Detergents, such as Alconox, may be sufficient
  - Should be phosphate-free

59

## Cleaning Glassware

- Residues of minerals and other substances can build up on glassware, causing erroneous test results
- If the water beads up on the inside of glassware *after* it has been cleaned, there is residue present

60

## Steps for Washing

- Clean glassware using laboratory detergent (phosphate-free)
- Rinse with tap water
- Rinse at least three times with distilled water
- Let air dry

61

## Steps for Acid-Washing

- Clean glassware using laboratory detergent (phosphate-free)
- Rinse with tap water
- Rinse with 1:1 hydrochloric acid or nitric acid
  - 1:1 means equal parts distilled water and acid
- Rinse well with distilled water
- Let air dry

Note: always use gloves and goggles when handling acids

62

## Laboratory Grade Water

- High quality lab grade water is essential
- Must be as free of contaminants as possible
  - Blanks, Standards, Etc.
- Follow manufacturer's instructions
  - Change filter cartridges regularly
  - Inspect distillation unit for scale build-up
- Water quality tested monthly
  - Conductivity, Chlorine residual, HPC, pH, etc.

63

## Laboratory Grade Water

- Two most common methods:
  1. Distillation – heating water to produce steam, which is condensed to a receiving bottle
  2. Deionization – passing water through a demineralization cartridge which removes contaminating ions



64

## Laboratory Grade Water

- Granular Activated Carbon
  - Primarily removes chlorine and organics
- Microfiltration
  - Cartridge filters 1-5 micron
  - Plugging monitored by differential pressure
    - Increase in pressure = filter plugging
- UV Sterilization
- Ultrafiltration
- Reverse Osmosis

65

## Key Points to Remember

- Volumetric pipets and flasks are most accurate
  - Do not blow out liquid
- Know how to read a meniscus
- Know how to properly clean glassware
  - Everyday washing
  - Acid washing

66

### Laboratory Equipment – Review Questions

1. Which type of glassware is used for mixing and measuring approximate volumes?
2. Which type of glassware is calibrated to provide the most accurate volume measurement?
3. Give an example of when you would need to use the type of glassware from question #2 in the lab.
4. Mark whether or not the following types of pipets should be blown out (the last drop is forced out with the bulb).
  - a. Volumetric –
  - b. Mohr –
  - c. Serological –
5. Explain the differences between “TC” and “TD” glassware.
6. Pipet bulbs can easily become contaminated and should be handled as such. True or False?
7. What is the proper way to read a meniscus?
8. What do you do with used glass pipets?
9. How long should glassware/equipment remain in the UV sterilization box in order to be properly sterilized?
10. What is the standard temperature setting for sterilization in an autoclave?

11. BOD incubators should be kept at what temperature? And how often should temperature be checked (for all appliances)?
  
12. What is the difference between a top loading balance and an analytical balance?
  
13. List the PPE that could be required in a wastewater laboratory.
  
14. Acids and Bases can be stored together in the same cabinet. True or False?
15. How often should eye wash stations and emergency showers be checked?
16. What type of detergent should be used to clean laboratory glassware?
  
17. List the standard procedure for washing glassware.
  
18. What is the purpose of acid washing glassware?
  
19. List the steps that are required for acid washing glassware.
  
20. How often should laboratory grade water be tested and the (in house) system inspected?



## Laboratory Vocabulary

>	Greater than; DO > 5 mg/L would be read: DO greater than 5 mg/L
<	Less than; DO < 5 mg/L would be read: Do less than 5 mg/L
<b>Aliquot</b>	Representative portion of a sample. Often, an equally divided portion of a sample
<b>Ambient Temperature</b>	Temperature of the surroundings
<b>Amperometric</b>	A method of measurement that records electric current flowing or generated, rather than recording voltage. Amperometric titration is a means of measuring concentrations of certain substances in water.
<b>Anaerobic Environment</b>	A condition where “free” or dissolved oxygen is NOT present in aquatic environment.
<b>Aseptic</b>	Free from the living germs of disease, fermentation or putrefaction. Sterile.
<b>Blank</b>	A bottle containing only dilution water or distilled water, but the sample being tested is not added. Tests are frequently run on a sample and a blank and the differences are compared.
<b>Buffer</b>	A solution or liquid whose chemical makeup neutralizes acids or bases without a great change in pH.
<b>Buffer Capacity</b>	A measure of the capacity of a solution or liquid to neutralize acids or bases. This is a measure of the capacity of water or wastewater for offering a resistance to changes in pH.
<b>Colorimetric Measurement</b>	A means of measuring unknown concentration of water quality indicators in a sample by measuring the sample’s color intensity. The color of the sample after the addition of specific chemicals (reagents) is compared with colors of known concentrations.

<b>Composite (Proportional) Samples</b>	A collection of individual samples obtained at regular intervals, usually every one or two hours during a 24-hour time span. Each individual sample is combined with the others in proportion to the flow when the sample was collected. The resulting mixture (composite sample) forms a representative sample and is analyzed to determine the average conditions during that sampling period.
<b>Compound</b>	A pure substance composed of two or more elements whose composition is constant. For example, table salt (sodium chloride, NaCl) is a compound.
<b>Desiccator</b>	A closed container that heated weighing or drying dishes are placed to cool in a dry environment. The dishes may be empty or they may contain a sample. Desiccators contain a substance, such as anhydrous calcium sulfate, which absorbs moisture and keeps the relative humidity near zero so that the dish or sample will not gain weight from absorbed moisture.
<b>Distillate</b>	In the distillation sample, a portion is evaporated; the part that is condensed afterwards is the distillate.
<b>Element</b>	A substance that cannot be separated into substances of other kinds by ordinary chemical means. For example, sodium (Na) is an element.
<b>End Point</b>	Samples are titrated to the end point. This means that a chemical is added, drop-by-drop, to a sample until a certain color change (blue to clear, for example) occurs that is called the end point of the titration. In addition to a color change, an end point may be reached by the formation of a precipitate or the reaching of a specified pH. An end point may be detected by the use of an electronic device such as a pH meter.
<b>Flame Polished</b>	Melted by a flame to smooth out irregularities. Sharp or broken edges of glass (such as the end of a glass tube) are rotated in a flame until the edge melts slightly and becomes smooth.
<b>Grab Sample</b>	A single sample of water or wastewater taken at neither a set time nor flow.
<b>Gravimetric</b>	A means of measuring unknown concentrations of water quality indicators in a sample by weighing a precipitate or residue of the sample.

**Indicator  
(Chemical)**

A substance that gives a visible change, usually of color, at a desired point in a chemical reaction, generally at a specified end point.

**M or Molar**

A molar solution consists of one gram molecular weight of a compound dissolved in enough water to make one liter of solution. A gram molecular weight is the molecular weight of a compound in grams. For example, the molecular weight of sulfuric acid ( $\text{H}_2\text{SO}_4$ ) is 98. A 1 M solution of sulfuric acid would consist of 98 grams of  $\text{H}_2\text{SO}_4$  dissolved in enough distilled water to make one liter of solution.

**MPN**

Most Probable Number of coliform group organisms per unit volume. Expressed at a density of population of organisms per 100 mL.

**Meniscus**

The curved top of a column of liquid (water, oil, mercury) in a small tube. When the liquid wets the sides of the container (as with water), the curve forms a valley. When the confining sides are not wetted (as with mercury), the curve forms a hill or upward bulge.

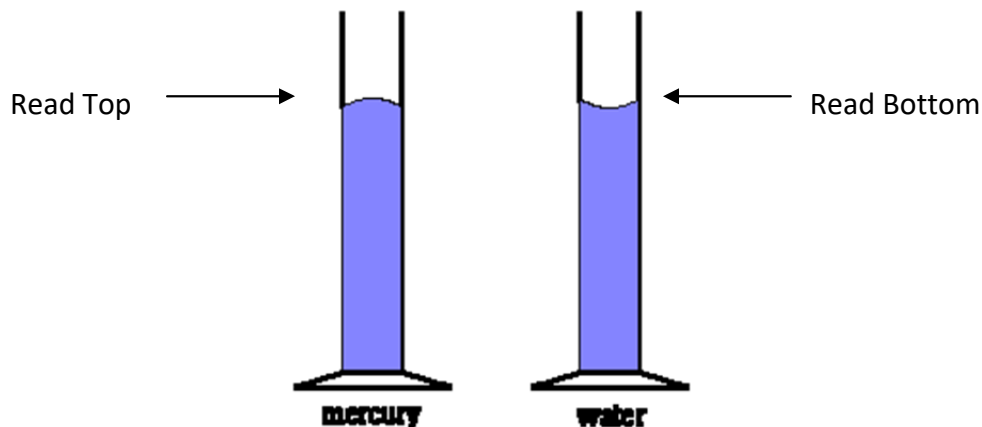
**Molecular  
Weight**

The molecular weight of a compound in grams is the sum of the atomic weights of the elements in the compound. The molecular weight of sulfuric acid ( $\text{H}_2\text{SO}_4$ ) in grams is 98.

ELEMENT	ATOMIC WEIGHT	NUMBER OF ATOMS	MOLECULAR WEIGHT
H	1	2	2
S	32	1	32
O	16	4	64
		Total Weight	98

<b>Molecule</b>	The smallest portion of an element or compound that still retains or exhibits all the properties of the substance.
<b><i>N</i> or Normal</b>	A normal solution contains one gram equivalent weight of reactant (compound) per liter of solution. The equivalent weight of an acid is that weight that contains one-gram atom of ionizable hydrogen or its chemical equivalent. For example, the equivalent weight of sulfuric acid ( $H_2SO_4$ ) is 49 (98 divided by 2 because there are two replaceable hydrogen ions). A 1 <i>N</i> solution of sulfuric acid would consist of 49 grams of $H_2SO_4$ dissolved in enough water to make one liter of solution.
<b>Oxidation</b>	The addition of oxygen, removal of hydrogen, or the removal of electrons from an element or compound. The opposite of reduction.
<b>Percent Strength</b>	The amount of a substance that is dissolved in a solution compared with the amount that could be dissolved in the solution, expressed as a percent.
<b>pH</b>	An expression of the intensity of the alkaline or acid condition of a water. Mathematically, pH is the logarithm (base 10) of the reciprocal of the hydrogen ion concentration. The pH may range from 0-14, where 0 is most acidic, 14 most alkaline and 7 is neutral. Natural waters usually have a pH between 6.5 and 8.5.
<b>Precipitate</b>	To separate (a substance) out in a solid form from a solution, as by the use of a reagent.
<b>Reagent</b>	A substance that takes part in a chemical reaction and is used to measure, detect or examine other substances.
<b>Reduction</b>	The addition of hydrogen, removal of oxygen, or the addition of electrons to an element or compound. The opposite of oxidation.
<b>Representative Sample</b>	A portion of material or water identical in content to that in the larger body of material or water being sampled.
<b>Solution</b>	A liquid mixture of dissolved substances. In a solution, it is impossible to see all the separate parts.
<b>Standard Solution</b>	A solution that the exact concentration of a chemical or compound is known.

<b>Titrate</b>	A chemical solution of known strength is added on a drop by drop basis until a color change, precipitate or pH change in the sample is observed (end point). This is the process of adding the chemical solution to completion of the reaction as signaled by the end point.
<b>Turbidity Units</b>	Expressed in Nephelometric Turbidity Units (NTU) when measure by a nephelometric (reflected light) instrument.
<b>Volumetric</b>	A means of measuring unknown concentrations of water quality indicators in a sample by determining the volume of titrant or liquid reagent needed to complete particular reactions.

## Cleaning Glassware

We often overlook the importance of clean glassware in the lab. We think if it looks clean, it must be clean. But there may be residues on the glassware that can affect our results. Since we use those results for both running the plant and reporting water quality to the state, it is important that those results be as accurate as possible.

For many purposes in the water treatment lab, washing in a detergent such as Alconox is sufficient. However, some analyses and some glassware require special cleaning procedures to ensure removal of all residues. Residues of minerals and other substances can build up on glassware, causing erroneous test results. Always follow the recommendations for cleaning glassware and sample containers, and always use the suggested type of sample container.

The following is a partial list of special cleaning procedures for laboratory glassware used for chemical analyses:

### Sample containers:

When collecting samples for metals analyses, special cleaning of the containers is necessary to prevent residues from affecting results. Clean the sample bottles by thoroughly washing with laboratory soap (preferably phosphate-free), followed by an acid wash and multiple rinses with distilled or deionized water. Do not use glass sample bottles for metals analysis.

### Sample cells and cuvetts:

Wash thoroughly using laboratory soap (preferably phosphate-free), followed by an acid wash and multiple rinses with distilled or deionized water. Allow to air dry or wipe with a Kim-wipe, don't use paper towels.

### Flasks, beakers, etc used for metals analysis:

Wash thoroughly using laboratory soap (preferably phosphate-free), followed by an acid wash and multiple rinses with distilled or deionized water.

### Pipets:

Soak overnight in a solution of Alconox. Rinse thoroughly using a pipet washer.

## Procedure for Acid Washing Glassware

If acid washing is required, follow these steps:

- Clean the glassware using laboratory detergent (phosphate-free)
- Rinse with tap water
- Rinse with 1:1 hydrochloric acid solution or 1:1 nitric acid solution
- Rinse well with distilled water
- Air dry

❖ Note: always use gloves and safety goggles when handling acids

## How to Read a Meniscus

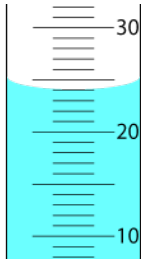

When using Graduated Cylinders the students must first learn how to read the meniscus. The meniscus is formed when the sides of the cylinder pull the water up the sides. This is due to adhesion. You should always read the bottom of the meniscus

### Steps to reading Graduated Cylinders:

1. Place the graduated cylinder on a level surface with the measurement lines facing you.
2. The water in a cylinder will form a curve called the meniscus
3. Your eye should be level with the top of the liquid
4. Find the bottom of the curved meniscus in the water. This should be in the center of the graduated cylinder.
5. Follow the lowest point at the surface of the water to the wall of the graduated cylinder. Read the volumetric scale at this point.

If you have trouble seeing the meniscus, try holding a black card against the opposite side of the graduated cylinder at the same height as the water.

Plastic cylinders may differ and the liquid level will have a flat surface. In that case you still read the center, not the edges.

### Samples:

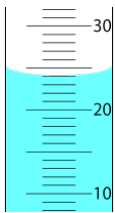

This reading would be 24

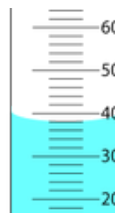

This reading would be 39

# SAMPLING

Wastewater Lab Class



1

## Why Sample?

1. Meet compliance requirements
2. Process control
3. Ensure public safety and protect the environment





Photo: www.10thmag.com

2

## Proper Sampling = Good Data

1. Sample is representative
2. Proper sampling techniques
3. Proper sample preservation
4. Chain of custody procedure



3

## Sampling Plan

Questions to consider before making a sampling plan:

1. Why is the sample being collected?
2. What tests need to be run on the sample?
3. Where is the sample going to be collected from?
4. How is the sample going to be collected?
5. When does the sample need to be collected/analyzed?
6. Who is going to analyze the sample?

4

## Considerations

- Collection
- Volume
- Storage and preservation
- Sample points
- Sampling frequency
- Include Sampling Plan in SOP

5

## Representative Sample

- A sample portion of material, water, or wastestream that is as nearly identical in content and consistency as possible to that in the larger body being sampled.
- Samples should be taken from the wastestream where it is well mixed.
- Frequency:
  - To represent typical weekdays
  - Varied from day to day within the week

6



## Grab Sample

- Single sample
  - *NPDES definition = a single influent or effluent sample collected at a particular time*
- Represents portion of water or wastewater at any one time
  - NOT the average
- Residual chlorine, dissolved oxygen, coliforms, *E. coli*, pH and temperature



7

## Composite Sample

- Collected at regular intervals
  - *NPDES definition = a combination of not less than 8 influent or effluent portions, of at least 100 mL, collected over a 24-hour period.*
  - Under certain circumstances a lesser time period may be allowed, but in no case, less than 8 hours

8

## Composite Sample

- Taking samples throughout the day, every 1 – 2 hours
- Once collected, refrigerated at 6°C
  - Bacterial decomposition
- In proportion to existing flow
  - As flow increases, more sample is collected
- Combined to form sample representative of entire flow for period



9

## Composite Sample

- Refrigerated and thoroughly mixed
  - Solids greater than one-quarter inch excluded
  - If not remixed, errors of 25 – 50% may occur
- Measure flow and sample volume
- BOD, total N, settleable solids
- NEVER use composite sample for bacterial analysis



10

## Sludge Sample

- Sludge solids vary considerably with pumping time
- Composite samples
- As a sludge sample stands, the solids and liquid will separate
- Do not store in sealed container
  - Digestion can produce gas
- Refrigeration is critical to prevent bacterial action

11

## Sampling Guidelines

- Representative
  - Well mixed
- Proper container
  - 40 CFR 136 Table II
- Do not contaminate the lid
- Preservative and/or dechlorinating agent



12

## Sampling Guidelines

- Hold by base
- Turn into current
- Avoid air bubbles



- Label containers with:
  1. Sample Location
  2. Date and Time of collection
  3. Name of collector
  4. Any other pertinent information

13

## Sample Labeling

Location: 196 E. Main Street, Springfield, TN

Date / Time: 9/22/2018 @ 8:15 AM

Sampled by: BS (Bob Smith)

Comments: grab sample  
pH < 2 with H<sub>2</sub>SO<sub>4</sub> and stored at 4°C

14

## Sample Labeling

- Special care must be taken not to contaminate samples.
  - This includes storing samples in a secure location to preclude conditions which could alter the properties of the sample. Samples shall be custody sealed during long-term storage or shipment.
- Documentation of field sampling is done in a bound logbook.



15

## Chain of Custody

- Written record to trace possession and handling of samples from collection to reporting
  - In case of legal litigation
- Used when sending out samples to contract lab
- Should identify who handled sample from collection to transport to storage to analysis to destruction
  - Including dates, times, initials, addresses, etc.

16

## Chain of Custody

- Collected samples are in the custody of the sampler or sample custodian until the samples are relinquished to another party.
  - If samples are transported by the sampler, they will remain under his/her custody or be secured until they are relinquished.

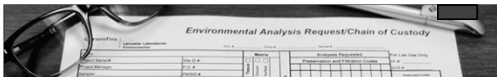

Photo: www.aardfrms.com

17

## CHAIN-OF-CUSTODY / Analytical Request Document

Photo Analytical

Section A: Agency, Date, Time, Location, State, Regulatory Agency (Ground Water, Drinking Water, Rain, Other)

Section B: Sample ID, Matrix Code, Date, Time, Location, State, Project No./Lab ID

Section C: Collector, Date, Time, Location, State, Project No./Lab ID

Section D: Relinquished to (Name, Date, Time, Signature)

Section E: Accepted by (Name, Date, Time, Signature)

Section F: Sample Condition

18

### Sample Volume

- Depends on test procedure
- Headspace for mixing
- Preservative
- QA/QC comparisons



19

### Sampling Point Selection

- Flow well mixed
- Exclude large particles (>1/4 inch)
- Exclude floating matter
- Readily accessible & in safe area

20

### Sampling Devices

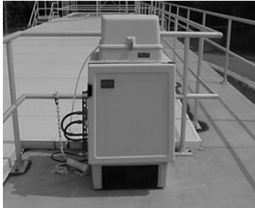

**Automatic:**

- Timesaver
- Composite: set to collect specific volumes over a period of time
- Clean intake line regularly to prevent growth of bacteria or algae

21

### Sampling Devices

**Manual:**

- Dippers
- Weighted bottle sampler
- Whirl-pak® bags
- Jugs

Simple Sampling Devices



Telescoping rod sampler with detachable plastic container.



Solid one-piece plastic pole with container.



22

### Sampling Devices

- Okay to improvise as long as the device can be properly cleaned
- Does this look like an approved device?



23

### Sampling Devices: Approved or Not?



24

## Subsurface Sampling

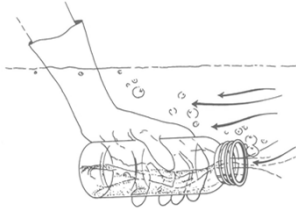

- Grasp container at base
- Plunge bottle mouth down into water
  - To avoid introducing any floating material
- Position mouth of bottle into current and away from hand
- Tip bottle slightly upward to allow air to exit so bottle can fill

25

## Homemade Depth Sampler

- Collection from basins, tanks, lakes, reservoirs
- Pre-marked steel cable
- Pre-measured/marked rope
  - non-smearing ink/paint
- A jerk on the cord will remove the stopper and allow the bottle to fill

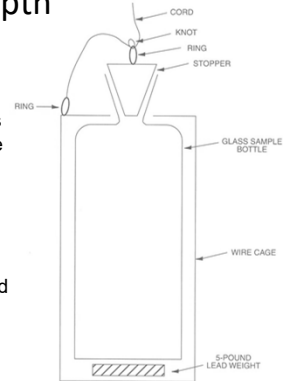

26

## Most Common Sources of Error

- Improper sampling
- Poor or improper sample preservation
- Lack of sufficient mixing during compositing and testing

27

## Preservation Techniques

- Refrigeration at 6°C
- pH<2:
  - \* Using HCl
  - \* Using H<sub>2</sub>SO<sub>4</sub>
  - \* Using HNO<sub>3</sub>
- pH>9 using NaOH
- pH>12 using NaOH

28

## Preservation

- Less time between collection and analysis = more reliable data
- Sample deterioration starts immediately after collection for most wastewaters
- Residual chlorine (TRC) and temperature require immediate analysis

29

## Any Questions?



30



9. Documentation of field sampling is done in a bound logbook.
  - a. True
  - b. False
  
10. What is a Chain of Custody and when would you most likely encounter one as an operator?
  
  
  
  
  
  
  
  
  
  
11. Improvised sampling devices are allowed as long as they can be properly cleaned.
  - a. True
  - b. False
  
12. When choosing a sampling point location, which of the following statements is **not** true?
  - a. The flow should be well mixed
  - b. The site should be readily accessible and in a safe location
  - c. The site should be in a corner where the water is still and easy to collect
  - d. Any floating matter or large particles should be excluded.
  
13. When you are performing subsurface sampling, you should position the mouth of the bottle away from the current.
  - a. True
  - b. False
  
14. List the most common sources of error when sampling.
  
  
  
  
  
  
  
  
  
  
15. Sample deterioration starts about 8 hours after collection for most wastewater.
  - a. True
  - b. False

## Section 2 Solutions Chemistry

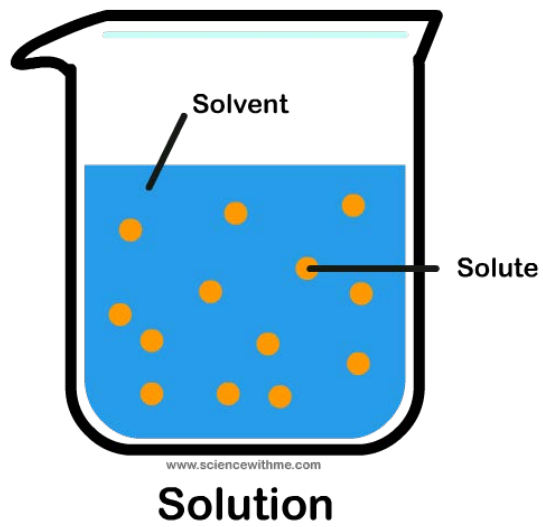

1

## Solutions Chemistry

Wastewater Treatment Laboratory



2

TDEC - Fleming Training Center

## Solutions

- A liquid mixture of dissolved substances
- A solution consist of two parts:
  - Solute
  - Solvent
- The solute part of the solution is dissolved in the solvent
- The most common solvent is water

3

TDEC - Fleming Training Center

## Concentration

- The measure of a solution that describes the amount of solute in the solvent
- Listed below are expressions for concentration:
  - milligrams per liter (mg/L)
  - grains per gallon
  - percent strength
  - molarity (M)
  - normality (N)

4

TDEC - Fleming Training Center

## Milligrams per Liter and Grains per Gallon

- These express weight per volume
- mg/L is the most commonly accepted measurement in water and wastewater industry
- 1ppm (part per million) is equivalent to 1 mg/L

5

TDEC - Fleming Training Center

## Percent Strength

- % Strength =  $\frac{\text{weight of solute}}{\text{weight of solution}}$
- Weight of Solution = Weight of solute + weight of solvent

6

TDEC - Fleming Training Center

## Compound

- Two or more different atoms “stuck” (chemically bonded) together
- When atoms of two or more elements are bonded together to form a compound, the resulting particle is called a **molecule**.
  - $N_2 \quad O_2 \quad Cl_2$
- Or a molecule may consist of several elements, with dozens of atoms bonded together
  - $C_{12}H_{22}O_{11}$





13

TDEC - Fleming Training Center

## How much do 2 moles of water weigh?

- $2\text{H}_2\text{O}$
- $(2 \text{ mol})(18 \text{ g/mol}) = 36 \text{ grams}$
- Therefore,  $2 \text{ mol} = 36 \text{ grams}$

14

TDEC - Fleming Training Center

## Normality

- **Normal solutions** are solutions which have a specific number of equivalent masses of the acid or base dissolved in the solution per liter. A 1 N solution (a 1 normal solution) contains 1 equivalent mass per liter, a 2 N solution contains 2 equivalent masses per liter, and so on.
- Normality =  $\frac{\text{number of equivalent weights of solute}}{\text{liters of solution}}$
- Number of equivalent weights =  $\frac{\text{total weight of solute}}{\text{equivalent weight}}$
- Equivalent weight =  $\frac{\text{molecular weight}}{\text{number of positive charges}}$

15

TDEC - Fleming Training Center

**Periodic Table of the Elements**

**KEY**

Atomic Mass → 12.011  
 Symbol → C  
 Atomic Number → 6  
 Electron Configuration → 2-4

Selected Oxidation States: +4, +2, -4

Relative atomic masses are based on  $^{12}\text{C} = 12.000$

Note: Mass numbers in parentheses are mass numbers of the most stable or common isotope.

16

TDEC - Fleming Training Center

## Periodic Table

**KEY**

Atomic Mass → 12.011  
 Symbol → C  
 Atomic Number → 6  
 Electron Configuration → 2-4

Selected Oxidation States: -4, +2, +4

Relative atomic masses are based on  $^{12}\text{C} = 12.000$

Note: Mass numbers in parentheses are mass numbers of the most stable or common isotope.

- Atomic number = number of protons
- Atomic Mass (or weight) = number of protons + neutrons in the nucleus

17

TDEC - Fleming Training Center

## Molarity and Normality

- How many grams of  $\text{Na}_2\text{CO}_3$  would it take to make 1 L of a 1 molar and a 1 normal solution?
- Step 1 - Determine molecular weight (mass of the molecule):
  - Na (2 moles of Na atoms) =  $22.99 \text{ amu} \times 2 = 45.98 \text{ amu}$
  - C (1 mole of C atom) =  $12.01 \text{ amu} \times 1 = 12.01 \text{ amu}$
  - O (3 moles of O atom) =  $16.00 \text{ amu} \times 3 = 48.00 \text{ amu}$
- Molecular weight (grams/mole) = 105.99 amu  
 (This means 1 mole of  $\text{Na}_2\text{CO}_3 = 105.99 \text{ grams}$ )
- $\text{Na}_2\text{CO}_3 \rightarrow \text{Na}^+ + \text{Na}^+ + \text{CO}_3^{2-}$

18

TDEC - Fleming Training Center

## Molarity

$$g = 1 \text{ mole} \times \frac{g}{\text{mole}} \text{ molecular weight}$$

- Step 2 - Calculate the grams required
  - grams required = (# moles required)(g/mole)
  - grams required =  $(1 \text{ mole})(105.99 \text{ g/mole})$
  - grams required = 105.99 g
- Step 3 - Calculate molarity of the solution
  - Molarity =  $\frac{\# \text{ moles}}{\text{volume of solvent}}$
  - Molarity =  $\frac{1 \text{ mole}}{1 \text{ liter of water}}$
  - Molarity = 1M
  - Every 105.99 grams of  $\text{Na}_2\text{CO}_3$  in 1L of water gives a 1M solution

19

TDEC - Fleming Training Center

### Molarity Shortcut

Na	=	22.99 amu x 2	=	45.98 amu
C	=	12.01 amu x 1	=	12.01 amu
O	=	16.00 amu x 3	=	<u>48.00 amu</u>
Molecular weight = 105.99 amu				

$\text{Na}_2\text{CO}_3 \rightarrow \text{Na}^+ + \text{Na}^+ + \text{CO}_3^{2-}$

- Grams required =

$$\frac{\text{mole}}{\text{liter}} (\text{Molarity needed}) \frac{\text{grams}}{\text{mole}} (\text{molecular wt}) \frac{\text{L}}{\text{liter}} (\text{L sol'n})$$

$$= (1\text{M})(105.99)(1\text{ L})$$

$$= 105.99\text{ g for a 1 molar solution}$$

20

TDEC - Fleming Training Center

### Normality

$\text{Na}_2\text{CO}_3 \rightarrow \text{Na}^+ + \text{Na}^+ + \text{CO}_3^{2-}$

- How many grams of  $\text{Na}_2\text{CO}_3$  would it take to make 1 L of a 1 normal solution?
- Step 2 - Calculate the equivalent weight for  $\text{Na}_2\text{CO}_3$ 
  - Equivalent weight =  $\frac{\text{molecular weight}}{\# \text{ of } (+) \text{ charges}}$
  - Equivalent weight =  $\frac{105.99}{2}$
  - Equivalent weight = 53 grams

21

TDEC - Fleming Training Center

### Normality

- Step 2b - Calculate the number of equivalents
  - #Equivalent weights =  $\frac{\text{total weight}}{\text{equivalent weights}}$
  - #Equivalent weights =  $\frac{105.99\text{ g}}{53\text{ g/equivalent}}$
  - #Equivalents = 2

22

TDEC - Fleming Training Center

### Normality

- OR Step 2c - Calculate the grams required
  - g required = (#equivalents)(g/equivalents)
  - g required = (2 equivalent wts)(53g/equivalents)
  - g required = 106

23

TDEC - Fleming Training Center

### Normality

- Step 3 - Calculate Normality
  - Normality =  $\frac{\# \text{ of equivalents}}{\text{volume of solvent}}$
  - Normality =  $\frac{2 \text{ equivalents}}{1\text{ L of water}}$
  - Normality = 2N
- Every 105.99 grams of  $\text{Na}_2\text{CO}_3$  in 1L of water gives a 2N solution
  - to make a 1N solution, cut the grams in half

24

TDEC - Fleming Training Center

### Normality Shortcut

Na	=	22.99 amu x 2	=	45.98 amu
C	=	12.01 amu x 1	=	12.01 amu
O	=	16.00 amu x 3	=	<u>48.00 amu</u>
Molecular weight = 105.99 amu				

$\text{Na}_2\text{CO}_3 \rightarrow \text{Na}^+ + \text{Na}^+ + \text{CO}_3^{2-}$

- Grams required =

$$= \frac{(\text{Normality needed})(\text{molecular weight})(\text{L sol'n})}{\# \text{ of positive charges}}$$

$$= \frac{(1\text{ N})(105.99)(1\text{ L})}{2}$$

$$= 53\text{ g for a 1N solution of Na}_2\text{CO}_3$$

25

TDEC - Fleming Training Center

## Standard Solutions

- A solution in which the exact concentration of a chemical or compound is known
- You standardize by comparing with a standard
  - Set up an instrument or device to read a standard
  - This allows you to adjust the instrument so that it reads accurately, or enables you to apply a correction factor to the readings

26

TDEC - Fleming Training Center

## Dilutions

- Weakening a stock solution
- Start with a stock solution, add an amount to the volumetric flask, and fill to mark
- Can use the following calculation with any expression of concentration or normality

Use this equation to make calculation:

$$C_1V_1 = C_2V_2$$

1 means stock or  
initial concentration  
or volume

2 is the concentration  
or volume you end  
up with

27

TDEC - Fleming Training Center

## Dilution Examples

- Operator has 12% bleach on hand and wants to make 25 gallons of 8%.

$$C_1V_1 = C_2V_2$$

$$(0.12)(V_1) = (0.08)(25 \text{ gal})$$

$$V_1 = \frac{(0.08)(25 \text{ gal})}{0.12}$$

$$V_1 = 16.7 \text{ gals}$$

28

TDEC - Fleming Training Center

## Dilution Examples

- Operator has 100 mL of 5N sulfuric acid on hand and wants to make 1N. How much water should be added?

$$C_1V_1 = C_2V_2$$

$$(5N)(100 \text{ mL}) = (1N)(V_2)$$

$$\frac{(5N)(100 \text{ mL})}{1N} = (V_2)$$

$$500 \text{ mL} = V_2$$

500 mL is final volume, you started with 100 mLs and added 400 mL to get a final volume of 500 mL

## Dilution of Concentrated Acids and Bases to Prepare a 1N Solution

Compound	Formula	Molecular Weight	Approximate Spec. Grav. Of Concentrated Reagent	Approximate % Present in Concentrated Reagent	Normality of Concentrated Reagent	Approximate mL of Concentrated Reagent to dilute to 1 L
Acetic Acid	$\text{CH}_3 \bullet \text{COOH}$	60.054	1.05	99.6	17.4	58
Ammonium Hydroxide	$\text{NH}_4\text{OH}$	35.048	0.90	57.6	14.8	68
Hydrochloric Acid	$\text{HCl}$	36.465	1.19	37.0	12.1	83
Lactic Acid	$\text{CH}_3 \bullet \text{CHOH} \bullet \text{COOH}$	90.081	1.21	85.0	11.4	88
Nitric Acid	$\text{HNO}_3$	63.016	1.42	69.5	15.7	64
Perchloric Acid	$\text{HClO}_4$	100.465	1.67	70.0	11.6	87
Phosphoric Acid (ortho-)	$\text{H}_3\text{PO}_4$	97.999	1.69	85.0	44.0	23
Potassium Hydroxide	$\text{KOH}$	56.108	1.51	50.0	13.5	75
Sodium Hydroxide	$\text{NaOH}$	39.999	1.53	50.0	19.1	53
Sulfuric Acid	$\text{H}_2\text{SO}_4$	98.082	1.84	96.0	36.0	28

Solutions Chemistry – Review Questions

1. What is a solution?
2. Solution = \_\_\_\_\_ + \_\_\_\_\_
3. What is a compound?
  - a. 2 or more atoms bonded (“stuck”) together by a chemical reaction
  - b. The smallest particle of an element that still retains the characteristics of that element
  - c. 2 or more atoms joined together by physical attraction
  - d. 2 or more atoms of the same element
4. What is a molecule?
  - a. The smallest portion of an atom
  - b. 2 or more atoms joined together by a chemical bond
  - c. 2 or more atoms joined together by physical attraction
  - d. A fundamental substance consisting of only one kind of atom
5. Write out the names of the chemicals that the following chemical formulas represent.
  - a. NaOH = \_\_\_\_\_
  - b. H<sub>2</sub>SO<sub>4</sub> = \_\_\_\_\_
  - c. CaCO<sub>3</sub> = \_\_\_\_\_
  - d. NaHCO<sub>3</sub> = \_\_\_\_\_
6. Fill in the missing blanks on this periodic table key:

KEY	
_____ →	12.011
_____ →	C
_____ →	6
Electron Configuration →	2-4
	-4
	+2
	+4

Selected Oxidation States

Relative atomic masses are based on <sup>12</sup>C = 12.000

**Note:** Mass numbers in parentheses are mass numbers of the most stable or common isotope.

7. Fill in the atomic mass (a.m.u.) of the following elements:

a. Na = \_\_\_\_\_

b. Ca = \_\_\_\_\_

c. H = \_\_\_\_\_

d. O = \_\_\_\_\_

e. N = \_\_\_\_\_

f. Cl = \_\_\_\_\_

g. S = \_\_\_\_\_

8. What is Normality?

9. What is Molarity?

10. What is a standard solution?

11. When do you use standard solutions in the lab?

## Wastewater Laboratory – Solutions Chemistry and Math

1. A laboratory solution is made using 52 milligrams of sodium chloride (NaCl) dissolved in 1-liter volumetric flask filled to the mark. What is the mg/L concentration of the solution?
2. If 33 pounds of a chemical is added to 148 pounds of water, what is the % strength by weight?
3. You are given 100 mL of 2.8N HCl. How many mL of water should be added to make 0.4N HCl?
4. 250 mL of 3N NaOH is diluted to 1000 mL. What is the new normality of the solution?
5. 500 mL of 10N NaOH is diluted to 1 liter. What is the new normality of the solution?





11. An operator needs a 0.2N solution in order to conduct analysis. The operator has 2.5N solution on hand. How many mL of the 2.5N solution is needed to make one-half liter of 0.2N solution?
12. An operator needs to make 1-liter of a 1N and a 1M solution of sodium bicarbonate ( $\text{NaHCO}_3$ ). How many grams would be needed for each? (Hint: bicarbonate =  $\text{HCO}_3$ ) (Hint #2: Look at page of "Common Valences")
13. An operator needs to make 1-liter of a 1N and a 1M solution of sodium hydroxide ( $\text{NaOH}$ ). How many grams would be needed for each? (Hint: Look at page of "Common Valences")

14. An operator needs to make  $\frac{1}{2}$ -liter of a 5N and a 5M solution of ferric sulfate  $\text{Fe}_2(\text{SO}_4)_3$ . How many grams would be needed for each? (Hint: Look at page of "Common Valences")

#### Answers

- |                    |                    |                     |
|--------------------|--------------------|---------------------|
| 1. 52 mg/L         | 8. 50 mL           | 13. 40 g for 1M     |
| 2. 18.2%           | 9. 2.25N           | 40 g for 1N         |
| 3. 600 mL to add   | 10. 292 mL to add  | 14. 999.78 g for 5M |
| 4. 0.75N           | 11. 40 mL          | 166.7 g for 5N      |
| 5. 5N              | 12. 84.01 g for 1M |                     |
| 6. 525.5 mL to add | 84.01 g for 1N     |                     |
| 7. 66.67 mL        |                    |                     |

# Periodic Table of the Elements

Period	1
	1.00794 <b>H</b> 1 1

18	4.00260 <b>He</b> 2 2
----	--------------------------------

**KEY**

Atomic Mass → 12.011 ← Selected Oxidation States

Symbol → **C**

Atomic Number → 6

Electron Configuration → 2-4

Relative atomic masses are based on <sup>12</sup>C = 12.000

**Note:** Mass numbers in parentheses are mass numbers of the most stable or common isotope.

										Group																			
1		2		3		4		5		6		7		8		9		10		11		12		13	14	15	16	17	18
2	6.941 <b>Li</b> 3 2-1	9.01218 <b>Be</b> 4 2-2																					10.81 <b>B</b> 5 2-3	12.011 <b>C</b> 6 2-4	14.0067 <b>N</b> 7 2-5	15.9994 <b>O</b> 8 2-6	18.998403 <b>F</b> 9 2-7	20.179 <b>Ne</b> 10 2-8	
3	22.98977 <b>Na</b> 11 2-8-1	24.305 <b>Mg</b> 12 2-8-2																					26.98154 <b>Al</b> 13 2-8-3	28.0855 <b>Si</b> 14 2-8-4	30.97376 <b>P</b> 15 2-8-5	32.06 <b>S</b> 16 2-8-6	35.453 <b>Cl</b> 17 2-8-7	39.948 <b>Ar</b> 18 2-8-8	
4	39.0983 <b>K</b> 19 2-8-8-1	40.08 <b>Ca</b> 20 2-8-8-2	44.9559 <b>Sc</b> 21 2-8-9-2	47.88 <b>Ti</b> 22 2-8-10-2	50.9415 <b>V</b> 23 2-8-11-2	51.996 <b>Cr</b> 24 2-8-13-1	54.9380 <b>Mn</b> 25 2-8-13-2	55.847 <b>Fe</b> 26 2-8-14-2	58.9332 <b>Co</b> 27 2-8-15-2	58.69 <b>Ni</b> 28 2-8-16-2	63.546 <b>Cu</b> 29 2-8-18-1	65.39 <b>Zn</b> 30 2-8-18-2	69.72 <b>Ga</b> 31 2-8-18-3	72.59 <b>Ge</b> 32 2-8-18-4	74.9216 <b>As</b> 33 2-8-18-5	78.96 <b>Se</b> 34 2-8-18-6	79.904 <b>Br</b> 35 2-8-18-7	83.80 <b>Kr</b> 36 2-8-18-8											
5	85.4678 <b>Rb</b> 37 2-8-18-8-1	87.62 <b>Sr</b> 38 2-8-18-8-2	88.9059 <b>Y</b> 39 2-8-18-9-2	91.224 <b>Zr</b> 40 2-8-18-10-2	92.9064 <b>Nb</b> 41 2-8-18-12-1	95.94 <b>Mo</b> 42 2-8-18-13-1	(98) <b>Tc</b> 43 2-8-18-14-1	101.07 <b>Ru</b> 44 2-8-18-15-1	102.906 <b>Rh</b> 45 2-8-18-16-1	106.42 <b>Pd</b> 46 2-8-18-18	107.868 <b>Ag</b> 47 2-8-18-18-1	112.41 <b>Cd</b> 48 2-8-18-18-2	114.82 <b>In</b> 49 2-8-18-18-3	118.71 <b>Sn</b> 50 2-8-18-18-4	121.75 <b>Sb</b> 51 2-8-18-18-5	127.60 <b>Te</b> 52 2-8-18-18-6	126.905 <b>I</b> 53 2-8-18-18-7	131.29 <b>Xe</b> 54 2-8-18-18-8											
6	132.905 <b>Cs</b> 55 2-8-18-18-8-1	137.33 <b>Ba</b> 56 2-8-18-18-8-2	138.906 <b>La</b> 57 2-8-18-18-9-2	178.49 <b>Hf</b> 72 **18-32-10-2	180.948 <b>Ta</b> 73 -18-32-11-2	183.85 <b>W</b> 74 -18-32-12-2	186.207 <b>Re</b> 75 -18-32-13-2	190.2 <b>Os</b> 76 -18-32-14-2	192.22 <b>Ir</b> 77 -18-32-15-2	195.08 <b>Pt</b> 78 -18-32-17-1	196.967 <b>Au</b> 79 -18-32-18-1	200.59 <b>Hg</b> 80 -18-32-18-2	204.383 <b>Tl</b> 81 -18-32-18-3	207.2 <b>Pb</b> 82 -18-32-18-4	208.980 <b>Bi</b> 83 -18-32-18-5	(209) <b>Po</b> 84 -18-32-18-6	(210) <b>At</b> 85 -18-32-18-7	(222) <b>Rn</b> 86 -18-32-18-8											
7	(223) <b>Fr</b> 87 -18-32-18-8-1	226.025 <b>Ra</b> 88 -18-32-18-8-2	227.028 <b>Ac</b> 89 -18-32-18-9-2	(261) <b>Rf</b> 104	(262) <b>Db</b> 105	(263) <b>Sg</b> 106	(264) <b>Bh</b> 107	(265) <b>Hs</b> 108	(268) <b>Mt</b> 109	(269) <b>Uun</b> 110	(272) <b>Uuu</b> 111	(277) <b>Uub</b> 112			(285) <b>Uuq</b> 114														

\*\*Denotes the presence of (2-8-) for elements 72 and above

\*The systematic names and symbols for elements of atomic numbers above 109 will be used until the approval of trivial names by IUPAC.

140.12 <b>Ce</b> 58	140.908 <b>Pr</b> 59	144.24 <b>Nd</b> 60	(145) <b>Pm</b> 61	150.36 <b>Sm</b> 62	151.96 <b>Eu</b> 63	157.25 <b>Gd</b> 64	158.925 <b>Tb</b> 65	162.50 <b>Dy</b> 66	164.930 <b>Ho</b> 67	167.26 <b>Er</b> 68	168.934 <b>Tm</b> 69	173.04 <b>Yb</b> 70	174.967 <b>Lu</b> 71
232.038 <b>Th</b> 90	231.036 <b>Pa</b> 91	238.029 <b>U</b> 92	237.048 <b>Np</b> 93	(244) <b>Pu</b> 94	(243) <b>Am</b> 95	(247) <b>Cm</b> 96	(247) <b>Bk</b> 97	(251) <b>Cf</b> 98	(252) <b>Es</b> 99	(257) <b>Fm</b> 100	(258) <b>Md</b> 101	(259) <b>No</b> 102	(260) <b>Lr</b> 103

1

# Periodic Table of the Elements

18

1 <b>H</b> Hydrogen 1.008																	2 <b>He</b> Helium 4.003
3 <b>Li</b> Lithium 6.941	4 <b>Be</b> Beryllium 9.012											5 <b>B</b> Boron 10.811	6 <b>C</b> Carbon 12.011	7 <b>N</b> Nitrogen 14.007	8 <b>O</b> Oxygen 15.999	9 <b>F</b> Fluorine 18.998	10 <b>Ne</b> Neon 20.180
11 <b>Na</b> Sodium 22.990	12 <b>Mg</b> Magnesium 24.305											13 <b>Al</b> Aluminum 26.982	14 <b>Si</b> Silicon 28.086	15 <b>P</b> Phosphorus 30.974	16 <b>S</b> Sulfur 32.066	17 <b>Cl</b> Chlorine 35.453	18 <b>Ar</b> Argon 39.948
19 <b>K</b> Potassium 39.098	20 <b>Ca</b> Calcium 40.078	21 <b>Sc</b> Scandium 44.956	22 <b>Ti</b> Titanium 47.867	23 <b>V</b> Vanadium 50.942	24 <b>Cr</b> Chromium 51.996	25 <b>Mn</b> Manganese 54.938	26 <b>Fe</b> Iron 55.845	27 <b>Co</b> Cobalt 58.933	28 <b>Ni</b> Nickel 58.693	29 <b>Cu</b> Copper 63.546	30 <b>Zn</b> Zinc 65.38	31 <b>Ga</b> Gallium 69.723	32 <b>Ge</b> Germanium 72.631	33 <b>As</b> Arsenic 74.922	34 <b>Se</b> Selenium 78.971	35 <b>Br</b> Bromine 79.904	36 <b>Kr</b> Krypton 84.798
37 <b>Rb</b> Rubidium 84.468	38 <b>Sr</b> Strontium 87.62	39 <b>Y</b> Yttrium 88.906	40 <b>Zr</b> Zirconium 91.224	41 <b>Nb</b> Niobium 92.906	42 <b>Mo</b> Molibdenum 95.95	43 <b>Tc</b> Technetium 98.907	44 <b>Ru</b> Ruthenium 101.07	45 <b>Rh</b> Rhodium 102.906	46 <b>Pd</b> Palladium 106.42	47 <b>Ag</b> Silver 107.868	48 <b>Cd</b> Cadmium 112.414	49 <b>In</b> Indium 114.818	50 <b>Sn</b> Tin 118.711	51 <b>Sb</b> Antimony 121.760	52 <b>Te</b> Tellurium 127.6	53 <b>I</b> Iodine 126.904	54 <b>Xe</b> Xenon 131.29
55 <b>Cs</b> Cesium 132.905	56 <b>Ba</b> Barium 137.328	57-71 Lanthanides	72 <b>Hf</b> Hafnium 178.49	73 <b>Ta</b> Tantalum 180.948	74 <b>W</b> Tungsten 183.84	75 <b>Re</b> Rhenium 186.207	76 <b>Os</b> Osmium 190.23	77 <b>Ir</b> Iridium 192.217	78 <b>Pt</b> Platinum 195.085	79 <b>Au</b> Gold 196.967	80 <b>Hg</b> Mercury 200.592	81 <b>Tl</b> Thallium 204.383	82 <b>Pb</b> Lead 207.2	83 <b>Bi</b> Bismuth 208.980	84 <b>Po</b> Polonium [208.982]	85 <b>At</b> Astatine 209.987	86 <b>Rn</b> Radon 222.018
87 <b>Fr</b> Francium 223.020	88 <b>Ra</b> Radium 226.025	89-103 Actinides	104 <b>Rf</b> Rutherfordium [261]	105 <b>Db</b> Dubnium [262]	106 <b>Sg</b> Seaborgium [266]	107 <b>Bh</b> Bohrium [264]	108 <b>Hs</b> Hassium [269]	109 <b>Mt</b> Meitnerium [268]	110 <b>Ds</b> Darmstadtium [269]	111 <b>Rg</b> Roentgenium [272]	112 <b>Cn</b> Copernicium [277]	113 <b>Uut</b> Ununtrium unknown	114 <b>Fl</b> Flerovium [289]	115 <b>Uup</b> Ununpentium unknown	116 <b>Lv</b> Livermorium [298]	117 <b>Uus</b> Ununseptium unknown	118 <b>Uuo</b> Ununoctium unknown

57 <b>La</b> Lanthanum 138.905	58 <b>Ce</b> Cerium 140.116	59 <b>Pr</b> Praseodymium 140.908	60 <b>Nd</b> Neodymium 144.243	61 <b>Pm</b> Promethium 144.913	62 <b>Sm</b> Samarium 150.36	63 <b>Eu</b> Europium 151.964	64 <b>Gd</b> Gadolinium 157.25	65 <b>Tb</b> Terbium 158.925	66 <b>Dy</b> Dysprosium 162.500	67 <b>Ho</b> Holmium 164.930	68 <b>Er</b> Erbium 167.259	69 <b>Tm</b> Thulium 168.934	70 <b>Yb</b> Ytterbium 173.055	71 <b>Lu</b> Lutetium 174.967
89 <b>Ac</b> Actinium 227.028	90 <b>Th</b> Thorium 232.038	91 <b>Pa</b> Protactinium 231.036	92 <b>U</b> Uranium 238.029	93 <b>Np</b> Neptunium 237.048	94 <b>Pu</b> Plutonium 244.064	95 <b>Am</b> Americium 243.061	96 <b>Cm</b> Curium 247.070	97 <b>Bk</b> Berkelium 247.070	98 <b>Cf</b> Californium 251.080	99 <b>Es</b> Einsteinium [254]	100 <b>Fm</b> Fermium 257.095	101 <b>Md</b> Mendelevium 258.1	102 <b>No</b> Nobelium 259.101	103 <b>Lr</b> Lawrencium [262]

## Common Valences

---

1+	2+	3+
Ammonium, $\text{NH}_4^+$ Cuprous, $\text{Cu}^+$ Hydrogen, $\text{H}^+$ Hydronium, $\text{H}_3\text{O}^+$ Potassium, $\text{K}^+$ Silver, $\text{Ag}^+$ Sodium, $\text{Na}^+$	Barium, $\text{Ba}^{2+}$ Calcium, $\text{Ca}^{2+}$ Cupric, $\text{Cu}^{2+}$ Ferrous, $\text{Fe}^{2+}$ Lead, $\text{Pb}^{2+}$ Magnesium, $\text{Mg}^{2+}$ Mercuric, $\text{Hg}^{2+}$ Nickel, $\text{Ni}^{2+}$ Zinc, $\text{Zn}^{2+}$	Aluminum, $\text{Al}^{3+}$ Chromic, $\text{Cr}^{3+}$ Ferric, $\text{Fe}^{3+}$

---

1-	2-	3-
Acetate, $\text{C}_2\text{H}_3\text{O}_2^-$ Bicarbonate, $\text{HCO}_3^-$ Bromide, $\text{Br}^-$ Chlorate, $\text{ClO}_3^-$ Chloride, $\text{Cl}^-$ Hydroxide, $\text{OH}^-$ Iodide, $\text{I}^-$ Nitrate, $\text{NO}_3^-$ Nitrite, $\text{NO}_2^-$ Bisulfate, $\text{HSO}_4^-$	Carbonate, $\text{CO}_3^{2-}$ Chromate, $\text{CrO}_4^{2-}$ Peroxide, $\text{O}_2^{2-}$ Sulfate, $\text{SO}_4^{2-}$ Sulfide, $\text{S}^{2-}$ Sulfite, $\text{SO}_3^{2-}$	Phosphate, $\text{PO}_4^{3-}$

---

## Section 3 Chlorine

### Breakpoint Chlorination

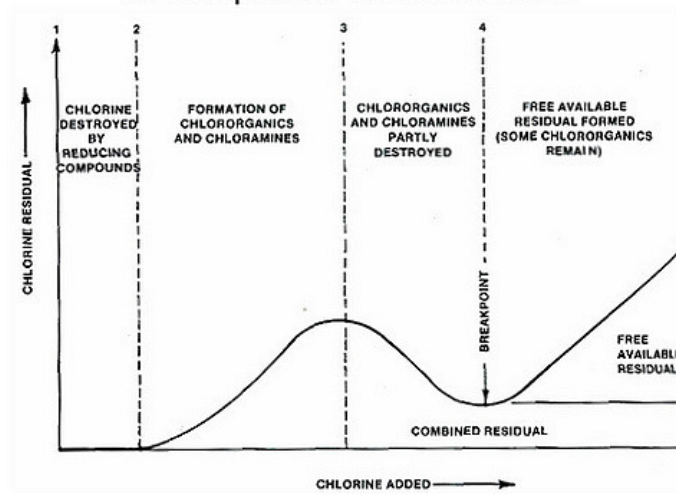

TDEC - Fleming Training Center 1

# CHLORINE DISINFECTION

Wastewater Laboratory



TDEC - Fleming Training Center 2

## Chlorine Uses in WWTP

- Disinfection
- Reduce BOD
- Odor control
- Improve scum and grease removal
- Control activated sludge bulking
- Foam control
- Filter fly control

TDEC - Fleming Training Center 3

## Disinfection

- Disinfection is the process that destroys pathogens.
- This is usually through the addition of chlorine.
- Other methods:
  - Heat
  - Bromine
  - Iodine
  - Ozone
  - UV

Chlorination
Hypochlorination
Ozonation
Ultraviolet irradiation

TDEC - Fleming Training Center 4

## Disinfection

- The most important purpose of chlorination of wastewater is disinfection of the plant effluent.
- It minimizes the potential health hazard to humans from waterborne diseases.
- The amount of chlorine necessary to obtain a satisfactory reduction of bacteria will vary greatly with each plant effluent.
- Do not overchlorinate!!!
- Remember the amount of chlorine required will decrease as the quality of your plant effluent improves.

TDEC - Fleming Training Center 5

## Odor Control

- Anaerobic conditions will produce hydrogen sulfide with its characteristic rotten egg smell.
- Chlorine can break down hydrogen sulfide as well as other odor producing bacteria.

TDEC - Fleming Training Center 6

## Control of Activated Sludge Bulking



- When sludge bulking has been traced to filamentous organisms and the situation doesn't improve by adjusting F:M ratio and nutrient levels, then chlorination may help.
- Chlorination should only be continued until the filamentous population has decreased and a normal bacteria population has established itself.
- Do not overchlorinate, as you could kill the whole process
- The chlorine is added to the return sludge line



TDEC - Fleming Training Center 7

## Chlorine

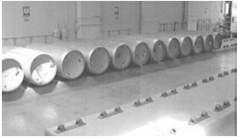
- Gaseous
  - Cl<sub>2</sub>
  - 100% pure
- Calcium hypochlorite
  - Ca(OCl)<sub>2</sub>
  - 65%
- Sodium hypochlorite (bleach)
  - NaOCl
  - 5.25 – 15%

TDEC - Fleming Training Center 8

## Chlorine Properties

- Physical
  - **Greenish-yellow**, with a penetrating and characteristic odor
  - **2.5 times heavier than air**
- Chemical
  - Not corrosive when dry, but very corrosive when mixed with water
  - Chlorine will support combustion and should not be stored near flammable materials
  - Chlorine itself is nonflammable and nonexplosive

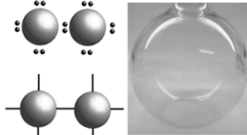

TDEC - Fleming Training Center 9

## Chlorine Properties



- Toxicity
  - Chlorine gas can be detected by smell by most persons at low concentrations
  - It is a respiratory irritant that will make you cough
  - It can cause irritation to the skin and lungs to a degree that depends upon the concentration and exposure time
  - In severe cases, chlorine gas can cause death from suffocation
  - Liquid chlorine will cause skin “burns” on contact, then it will vaporize and act like chlorine gas
  - Just remember, if you **suspect a chlorine gas leak or smell chlorine gas, get out of the area**

TDEC - Fleming Training Center 10

## Storage of Chlorine

- **\*\*Do not store in the same room as the dechlorinator (sulfur dioxide, sodium bisulfite, sodium metabisulfite, etc.)**
- Exhaust fan intake and exhaust for chlorine storage room located at floor level
- Switches for fans and lights outside cylinder room
- **Ammonium hydroxide** on hand to test for leaks
  - Produces a white cloud
- If you do have a leak: **2 in 2 out** - required for emergencies; **DO NOT BE A HERO**

TDEC - Fleming Training Center 11

## Affects on pH

- Hypochlorination causes pH to **↑**

$$\text{NaOCl} + \text{H}_2\text{O} \rightarrow \text{NaOH} + \text{HOCl}$$

$$\text{HOCl} \rightarrow \text{OCl}^- + \text{H}^+ \text{ (@pH > 7)}$$
- Gas chlorination causes pH to **↓**

$$\text{Ca(OCl)}_2 + \text{H}_2\text{O} \rightarrow \text{HOCl} + \text{Ca(OH)}_2$$

$$\text{Cl}_2 + \text{H}_2\text{O} \rightarrow \text{HOCl} + \text{HCl}$$
- hypochlorous acid (HOCl) and the hypochlorite (OCl<sup>-</sup>)

TDEC - Fleming Training Center 12

## Chlorine Demand

- The difference between the chlorine added to the water and the amount of residual chlorine remaining after a given time.

$$\text{Demand} = \text{Chlorine Dose} - \text{Chlorine Residual}$$

$$\text{Dose} = \text{Chlorine Demand} + \text{Chlorine Residual}$$



## Breakpoint Chlorination

- <https://www.youtube.com/watch?v=Auz0cpObj18>

## Total vs. Free Chlorine

- The level of total chlorine will always be higher than or equal to the level of free chlorine.
- Free chlorine is typically measured in drinking water disinfection systems using chlorine gas or sodium hypochlorite to find whether the water system contains enough disinfectant.
  - Typical levels of free chlorine in drinking water are 0.2 - 2.0 mg/L Cl<sub>2</sub>, though levels can be as high as 4.0 mg/L.
- Total chlorine is typically measured to determine the total chlorine content of treated wastewater, often for discharge purposes.

## DPD Method

- Standard Method 4500-Cl G
- Grab sample, no preservative
- Analyze samples immediately (holding time is 15 minutes)
  - After adding the reagent, a pink color will develop if chlorine is present
  - Wipe the outside of the sample cell with a wet then a dry towel to remove fingerprints
- **DPD - N,N Diethyl-1,4 Phenylenediamine Sulfate**

## DPD Method - continued

- Hach Procedure:
  - Add DPD to sample and swirl for 20 seconds to mix
  - Wait for a three-minute reaction period
    - Use a timer
  - Within three minutes after timer has ended, read sample

## DPD Method - continued

- Interferences
  - Alkalinity > 300 mg/L as CaCO<sub>3</sub>
  - Extreme pH: adjust to 6-7 using sulfuric acid or sodium hydroxide (1N)
- Sampling
  - Avoid plastic containers
  - If sampling from a tap, let the water flow at least 5 minutes to ensure a representative sample

## Total Residual Chlorine SM4500-Cl G - 2000, DPD

- DOC
- MDL
- LRB
- LFB
- Dup
- ICAL/CCV
- Control Charts
- Corrective Action
- QC Acceptance
- Batch Size
- QC Frequency



TDEC - Fleming Training Center

25

### Total Residual Chlorine SM4500-Cl G - 2000, DPD

- Demonstration of Capability (DOC)
  - Run a laboratory-fortified blank (LFB) at least four times and compare to the limits listed in the method
    - No limits listed for chlorine
- Real people language: each operator running this test need to analyze 4 samples of a Chlorine Standard or Potassium Permanganate (KMnO<sub>4</sub>) at a concentration around 0.5 mg/L.
- Documentation (signed form) that analyst has read and understands all appropriate SOPs and Methods.
- Recommend backup analyst do this once a year.

TDEC - Fleming Training Center

26

### Total Residual Chlorine SM4500-Cl G - 2000, DPD

- Method Detection level
  - HACH- Estimated Detection Level=0.02mg/L
  - From SM 1030 C.
    - 0.02 mg/L \* 5= 0.10 mg/L~ MDL
    - **Make a 0.10 mg/L standard**
    - **Analyze 7 portions over ≥ 3 days**
    - Calculate standard deviation (s)
    - $n1 \Sigma + n2 \Sigma + n3 \Sigma + \dots + n7 \Sigma + 2^{nd} \sigma_{xn} = s$
    - $s * 3.14 = MDL$

TDEC - Fleming Training Center

27

### Total Residual Chlorine SM4500-Cl G - 2000, DPD

- Method Blank
  - Real people language: analyze distilled water as a sample by adding DPD powder pillow and waiting the 3-6 minutes before reading
    - Target value is less than MDL
    - **2014 Update – run on a 5% basis instead of daily**
- Laboratory Fortified Blank
  - Real people language: analyze a chlorine standard or potassium permanganate (KMnO<sub>4</sub>) at a concentration around 0.5 mg/L
    - Run on a 5% basis, one for every 20 samples

TDEC - Fleming Training Center

28

### Total Residual Chlorine SM4500-Cl G - 2000, DPD

- Duplicates
  - Run on a 5% basis, one for every 20 samples
  - Calculate %RPD, ≤ 20%
  - **2014 Update – For reporting purposes, average sample and duplicate.**

TDEC - Fleming Training Center

29

### Total Residual Chlorine SM4500-Cl G - 2000, DPD

- Initial Calibration
  - Prepare a set of chlorine standard or potassium permanganate (KMnO<sub>4</sub>) in accordance with the Guidance for Secondary Standards Use in Calibration **monthly**.
    - Once per month at minimum, before the use of new DPD reagents, or the use of new gel standards



TDEC - Fleming Training Center

30

### Total Residual Chlorine SM4500-Cl G - 2000, DPD

- Stock Standard Solution
  - 0.891 grams of reagent grade KMnO<sub>4</sub> in 1000 mL vol. flask made to mark with deionized water.
  - Deionized water must never be stored in plastic containers or exposed to airborne contamination.
  - Store the stock solution in amber bottle in a cool area.
  - The typical shelf life of the stock solution is six (6) months.
  - If solids appear in the solution, **do not use**.

TDEC - Fleming Training Center 31

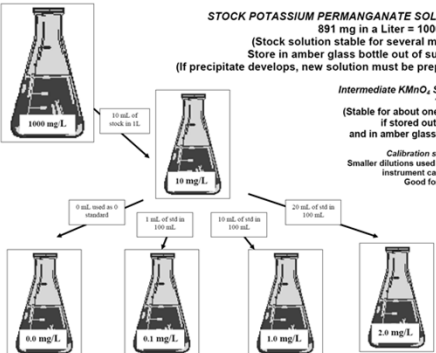

**STOCK POTASSIUM PERMANGANATE SOLUTION**  
 891 mg in a Liter = 1000 mg/L  
 (Stock solution stable for several months)  
 Store in amber glass bottle out of sunlight.  
 (If precipitate develops, new solution must be prepared.)

**Intermediate  $KMnO_4$  Solution**  
 10 mg/L  
 (Stable for about one month  
 if stored out of light  
 and in amber glass bottle.)

**Calibration standards**  
 Smaller dilutions used to check  
 instrument calibration.  
 Good for 8 hours

TDEC - Fleming Training Center 32

### Total Residual Chlorine SM4500-CI G - 2000, DPD

- Intermediate (Working) Standard Solution
  - 10 mL of STOCK made in 1000 mL vol. flask made to mark with deionized water.
  - The flask should be labeled with the name,  $KMnO_4$ , date of preparation, initials of who made it.
  - This information should also be entered into a logbook.
- **\*\*The intermediate stock solution should be stable for approximately 5 days if kept cool and away from light.\*\***

TDEC - Fleming Training Center 33

### Total Residual Chlorine SM4500-CI G - 2000, DPD

- Potassium Permanganate Standard Solution
  - Care should be taken that the pipette and glassware are clean and thoroughly rinsed with deionized water to avoid contamination.
  - Store only in glass container (preferably amber glass) never in plastic containers.
  - The working solution should be remade if solids appear in the bottom of the container.

TDEC - Fleming Training Center 34

### Total Residual Chlorine SM4500-CI G - 2000, DPD

- Calibration Standard Solutions
  - Four to five calibration standard solutions should be made according to the table below to create a calibration curve once per month at a minimum.
  - The linear regression of the curve should correlate to 0.995 or better.
  - This curve is then used to check or calibrate the instrument.
  - Gel standards are run against the curve and must agree to within + 10%.
- **\*\*The working solution should be stable for approximately 2 hours and will fade rapidly (within 15 minutes) if chlorine demand-free water is not used.\*\***

TDEC - Fleming Training Center 35

### Total Residual Chlorine SM4500-CI G - 2000, DPD

- Calibration Standard Solutions
  - A target value (e.g. permit value for a facility) should be known and three gel standards, 0.00 mg/L, blank, and two other standards (a low and a high standard) that bracket the target value should be chosen.
  - Gel standards are run against the curve and must agree to within + 10%.

TDEC - Fleming Training Center 36

### Total Residual Chlorine SM4500-CI G - 2000, DPD

mL Working Standard Diluted w/Deionized water	Chlorine Equivalent mg/L
20 mL (vol. Pipette) to 100 mL (vol. flask)	2.0 mg/L
10 mL (vol. Pipette) to 100 mL (vol. flask)	1.0 mg/L
5 mL (vol. Pipette) to 100 mL (vol. flask)	0.5 mg/L
1 mL (vol. Pipette) to 100 mL (vol. flask)	0.1 mg/L
1 mL (vol. Pipette) to 200 mL (vol. flask)	0.05 mg/L
1 mL (vol. Pipette) to 500 mL (vol. flask)	0.02 mg/L
100 mL of deionized water	0.00 mg/L

TDEC - Fleming Training Center **37**

### Total Residual Chlorine SM4500-Cl G - 2000, DPD

- Calibration Verification
  - Verify meter daily with secondary gel standards using a minimum of one blank and two gel standards that bracket the expected sample concentration



TDEC - Fleming Training Center **38**

### Total Residual Chlorine SM4500-Cl G - 2000, DPD

- **2014 Update** - Create and maintain control charts if you have 20-30 data points within 90 days.
- If you do not meet the above criteria, follow QC Acceptance Criteria below.
  - Blanks < MDL
  - LFB  $\pm$  15%
  - ICV/CCV  $\pm$  10%
  - RPD < 20%
  - Reporting limit = MDL

TDEC - Fleming Training Center **39**

### Orion Electrode TRC Method

- Model 97-70 chlorine electrode
- Meter – direct reading selective ion or expanded scale pH/millivolt
- Standardization performed with three standards and a reagent blank
- Calculation – concentration determined by direct reading

TDEC - Fleming Training Center **40**

### Amperometric Titration

- Most sensitive and most complex method
- Least affected by interferences
- Training in proper determination technique
- Titrant initially verified and periodically checked
- Fresh titrant and proper buret
- Titrant storage – dark and cool



TDEC - Fleming Training Center **41**

### Amperometric Titration

- Apparatus
  - Amperometric Titrator (Wallace & Tiernan)
  - Buret with 0.01 mL increments
- Reagents
  - Phenylarsine oxide titrant, 0.00564N
  - Potassium Iodide solution (KI solution)
  - Acetate Buffer solution

TDEC - Fleming Training Center **42**

### Amperometric Titration - Procedure

- Fill burette with 0.0056N phenylarsine oxide solution (PAO)
- Measure 200 mL of sample into the cell and place in the holder on the titrator
- Add 1 mL Potassium Iodide (KI) solution (5% solution)
- Add 1 mL acetate buffer solution
- Turn on stirrer and adjust control knob until the meter reads the maximum on the scale

### Amperometric Titration - Procedure

- Add phenylarsine oxide in 0.01 mL increments.
  - This should cause the meter reading to deflect downward.
  - Adjust the control knob as needed to keep the pointer on the scale.
  - The end-point is reached when the addition of titrant no longer results in a downward deflection.
- Read the burette, subtracting the amount of the last addition (which did not cause a downward deflection).
  - The burette reading in mL equals the free chlorine residual in mg/L.

### Common Deficiencies

- Sampling and analyses times were not documented for field parameters
- Standards weren't analyzed to verify the accuracy of the chlorine meter
- Measuring free residual chlorine
- Non-approved method being used to measure TRC
- TRC was being measured on the composite sample

### Chlorine Problems

Oh no, not math problems!!

### Chlorine Problems

- A chlorinator is set to feed 50 pounds of chlorine per 24 hours. The wastewater flow rate is 0.85 MGD. The chlorine measured after 30 minutes of contact time is 0.5 mg/L. Find the chlorine dosage and demand in mg/L.

$$\text{Dose, mg/L} = \frac{\text{chlorine, lbs/day}}{(Q, \text{MGD})(8.34 \text{ lbs/gal})}$$

$$\text{Dose, mg/L} = \frac{50 \text{ lbs/day}}{(0.85 \text{ MGD})(8.34 \text{ lbs/gal})}$$

$$\text{Dose, mg/L} = 7.1 \text{ mg/L}$$

### Chlorine Problems

- A chlorinator is set to feed 50 pounds of chlorine per 24 hours. The wastewater flow rate is 0.85 MGD. The chlorine measured after 30 minutes of contact time is 0.5 mg/L. Find the chlorine dosage and demand in mg/L.

$$\text{Demand, mg/L} = \text{Cl}_2 \text{ Dose, mg/L} - \text{Cl}_2 \text{ Residual, mg/L}$$

$$\text{Demand, mg/L} = 7.1 \text{ mg/L} - 0.5 \text{ mg/L}$$

$$\text{Demand, mg/L} = 6.6 \text{ mg/L}$$

### Chlorine Problems

- The chlorine demand is determined to be **5 mg/L** and the plant flow rate is 8 MGD. How many pounds per day of gas chlorine should be fed? Include a **1 mg/L** residual.

$$\text{Cl}_2, \text{ lbs/day} = (\text{Dose, mg/L})(Q, \text{MGD})(8.34 \text{ lbs/gal})$$

$$\text{Cl}_2, \text{ lbs/day} = (6 \text{ mg/L})(8 \text{ MGD})(8.34 \text{ lbs/gal})$$

$$\text{Cl}_2, \text{ lbs/day} = 400 \text{ lbs/day}$$

## Chlorine Problems

- The chlorine demand is determined to be 5 mg/L and the plant flow rate is 8 MGD. How many pounds per day of HTH (65% chlorine) should be fed? Include a 1 mg/L residual.

$$\text{Cl}_2, \text{ lbs/day} = \frac{(\text{Dose, mg/L})(\text{Q, MGD})(8.34 \text{ lbs/gal})}{\text{HTH, chlorine percent as decimal}}$$

$$\text{Cl}_2, \text{ lbs/day} = \frac{(6 \text{ mg/L})(8 \text{ MGD})(8.34 \text{ lbs/gal})}{0.65}$$

$$\text{Cl}_2, \text{ lbs/day} = 616 \text{ lbs/day}$$



## Chlorine - Part 2

Calibration Curve, Secondary Standards, and Method Detection Limit (MDL)

## QC Requirements

- Initial Demonstration of Capability (DOC)
- Method Detection Limit (MDL)
- Initial Calibration Verification (ICV)
- Method Blank
- Laboratory Fortified Blank (LFB)
- Duplicate
- Continuing Calibration Verification (CCV)

## Calibration Curve

- Prepare a set of chlorine or potassium permanganate ( $\text{KMnO}_4$ ) standards (Primary Standards)
  - Create a calibration curve
    - For each instrument
    - Once a month (at minimum)
    - Before the use of new DPD reagents or the use of new gel standards
    - Record lot #s for reagents and standards
    - Record calibration concentrations

## Calibration Curve

- Correlation coefficient (r) of curve should be 0.995 or higher
- This curve is used to check or calibrate the instrument
- Gel standards are run against the curve and must meet the manufacturer's published acceptance criteria for the specific instrument being used

## Use of Secondary Standards

- Secondary standards = gel standards
- Designed to verify the instrument's calibration and check instrument's performance
- They are not used to create calibration curves
  - DPD reagent cannot be mixed with gel standard
  - Quality and reaction time of reagent can't be assessed
- Gel standards can not take the place of primary standards!

## Use of Secondary Standards

- Verify the calibration curve using a minimum of 1 blank and 2 gel standards that bracket your expected sample concentration
  - One above and one below the sample concentration
- Record all verification data

### KMnO<sub>4</sub> Stock Standard Solution

- Potassium permanganate
  - Primary Standard
- 0.891 grams of reagent grade KMnO<sub>4</sub> in 1000 mL vol. flask made to mark with deionized water.
- Deionized water must never be stored in plastic containers or exposed to airborne contamination. Store the stock solution in an amber bottle in a cool area.
- The typical shelf life of the stock solution is six (6) months. If solids appear in the solution, do not use
- \*\*\*Avoid leaving the cap off for extended periods of time and avoid contamination.\*\*\*

### Intermediate (Working) Standard Solution

- **10 mg/L**
- 10 mL of STOCK into a 1000 mL volumetric flask
- Made to mark with DI water
- Label flask with name, KMnO<sub>4</sub>, date of preparation, analyst initials
- Enter this info into bound logbook
- The intermediate stock solution should be stable for approximately 5 days if kept cool and away from light.

### Intermediate (Working) Standard Solution

- Care should be taken
  - Pipette and glassware are clean and thoroughly rinsed with DI water to avoid contamination
  - Store only in glass container, never plastic
    - Preferably amber glass to protect from light
- The working solution should be remade if solids appear in the bottom of the container

### Calibration Standards Solutions

- If using KMnO<sub>4</sub>:
  - 4 to 5 calibration standards should be made (see table on next slide) with the addition of DPD to create a calibration curve
    - Once a month at minimum
    - The correlation coefficient of the curve should correlate to 0.995 or better.
    - This curve is then used to check instrument calibration.
- Gel standards are run against the curve and must agree to within ± 10%
- The working solution should be stable for approximately 2 hours and will fade rapidly (within 15 minutes) if chlorine demand-free water is not used.

### ICV/CCV –Chlorine

mL Working Standard Diluted w/Deionized water	Chlorine Equivalent mg/L
20 mL (vol. Pipette) to 100 mL (vol. flask)	2.0 mg/L
10 mL (vol. Pipette) to 100 mL (vol. flask)	1.0 mg/L
5 mL (vol. Pipette) to 100 mL (vol. flask)	0.5 mg/L
1 mL (vol. Pipette) to 100 mL (vol. flask)	0.1 mg/L
1 mL (vol. Pipette) to 200 mL (vol. flask)	0.05 mg/L
1 mL (vol. Pipette) to 500 mL (vol. flask)	0.02 mg/L
100 mL of deionized water	0.00 mg/L

Don't forget to use DPD on Potassium Permanganate standards

### Calibration Standards Solutions

mL of working standard dilution added to mL of distilled or deionized water	Cl <sub>2</sub> equivalent
Distilled or deionized water	0.00 mg/L
1.0 mL (vol. pipette) to 500 mL (vol. flask)	0.02 mg/L
1 mL (vol. pipette) to 100 mL (vol. flask)	0.1 mg/L
5 mL (vol. pipette) to 100 mL (vol. flask)	0.5 mg/L
10 mL (vol. pipette) to 100 mL (vol. flask)	1.0 mg/L
20 mL (vol. pipette) to 100 mL (vol. flask)	2.0 mg/L

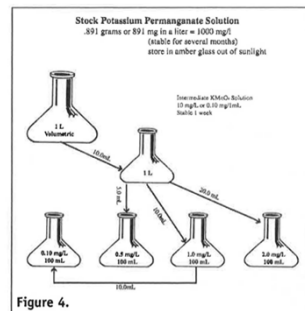

Today in the lab, we will be creating Calibration Standard Solutions

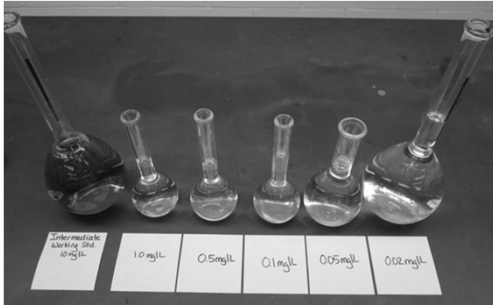

Subject	true value (x)	value read (y)
1	0.02	0.02
2	0.05	0.03
3	0.10	0.05
4	0.50	0.42
5	1.00	0.91

$R^2 =$  **0.997567397**  
 Although, still greater than 0.995  
 Not a good recovery, try a second dilution

Calibration Standard Solutions



Subject	true value (x)	value read (y)
1	0.02	0.02
2	0.05	0.03
3	0.10	0.09
4	0.50	0.42
5	1.00	0.91

$R^2 =$  **0.99833**  
 Better than previous calibration curve  
 Better recovery with second dilution

### Method Detection Limit (MDL) Revision 2

- EPA definition: The minimum measured concentration of a substance that can be reported with 99% confidence that the measured concentration is distinguishable from method blank results

### Method Detection Limit (MDL) Revision 2

- Step (1): Estimate Initial MDL
  - The mean determined concentration plus 3 times the standard deviation of a set of method blanks
  - The concentration value that corresponds to an instrument signal-to-noise ratio in the range of 3 to 5
  - The concentration equivalent to three times the standard deviation of replicate instrumental measurements of spiked blanks
  - That region of the calibration where there is a significant change in sensitivity (i.e. a break in the slope of the calibration)
  - Instrumental limitations
  - Previously determined MDLs

### Method Detection Limit (MDL) Revision 2

- Step (2): Determine the Initial MDL
  - Select a spiking level, typically 2-10 times the estimated MDL
  - Process at least 7 spiked samples and 7 method blank samples
    - Ideally, use pooled data from several analysts
  - Must be prepared in at least 3 batches on 3 separate dates and analyzed on 3 separate dates
    - Preparation and analysis can be on the same day



### Method Detection Limit (MDL) Revision 2

- Initial MDL continued...
  - Existing data may be used if compliant with the requirements for at least 3 batches, and generated within the last 24 months
  - The most recent available data for method blanks and spiked samples must be used



### Method Detection Limit (MDL) Revision 2

- Initial MDL continued...
  - If multiple instruments will be assigned the same MDL, sample analyses must be distributed across all the instruments
  - Minimum of 2 spiked and 2 blank samples prepared and analyzed on different dates is required for each instrument
    - The same prepared extract may be analyzed on multiple instruments so long as the minimum requirement of 7 preparations in at least 3 separate batches is maintained

### Method Detection Limit (MDL) Revision 2

- Evaluate the spiking level
  - If any spiked samples do not provide a numerical result greater than zero, repeat the spiked sample at a higher concentration
- Compute MDL<sub>s</sub> – value based on s spiked samples
- Compute MDL<sub>b</sub> – value based on b blank samples
  - Use the MDL calculator on the FTC website
- Whichever is greater is your MDL

### Method Detection Limit (MDL) Revision 2

- Step (3): Ongoing Data Collection
  - During any quarter in which samples are being analyzed, prepare and analyze a minimum of two spiked samples on each instrument, in separate batches, using the same spiking concentration used for the Initial MDL
  - MDL<sub>s</sub>: Value calculated from the spiked samples
    - Minimum of 2 spiked samples on each instrument
    - Minimum of 8 per year (2 per quarter)
  - MDL<sub>b</sub>: value calculated from the method blanks
    - No additional samples required – just use the routine method blanks

### Method Detection Limit (MDL) Revision 2

- At least once per year, re-evaluate the spiking level
  - If more than 5% of spikes are not positive numerical results, the spiking level must be increased and initial MDL re-determined
- If the method is altered in a way that can be expected to change its sensitivity, re-determine the initial MDL and restart the ongoing data collection

### Method Detection Limit (MDL) Revision 2

- Step (4): Annual Verification
  - At least once every 13 months you need to re-calculate your MDL<sub>s</sub> and MDL<sub>b</sub>
    - Include data generated in the last 24 months
      - But only data with same spiking level
    - Ideally, use all method blank results from the last 24 months for the MDL<sub>b</sub> calculation
    - There is an option to use less data included in the rule

### Method Detection Limit (MDL) Revision 2

- The verified MDL is the higher of the two numbers (either the MDL<sub>s</sub> or the MDL<sub>b</sub>)
- Your existing MDL may be left unchanged if specific criteria are met
  - If verified MDL is within 0.5 – 2.0 times the existing MDL, and fewer than 3% of the method blank results have numerical results above the existing MDL
  - Otherwise, adjust the MDL to the new verification MDL

### Method Detection Limit (MDL) Revision 2

- Where do I find the MDL Calculator?
  1. Go to Fleming Training Center’s website
    - <https://www.tn.gov/environment/program-areas/wr-water-resources/fleming-training-center.html>
  2. On left side, click on “Course Books and Reference Material”
  3. In the drop-down menu, click on “Waste Water Information”
  4. Click on “Method Update Rule – Method Detection Limit Math 2018”

### Today in the lab we will also be determining the Initial MDL

- Setting up 7 spiked samples and 7 method blank samples
- \*\*Remember, in real life...
  - Use pooled data from several analysts
  - Must be prepared in at least 3 batches on 3 separate dates and analyzed on 3 separate dates

### Method Detection Limit (MDL)

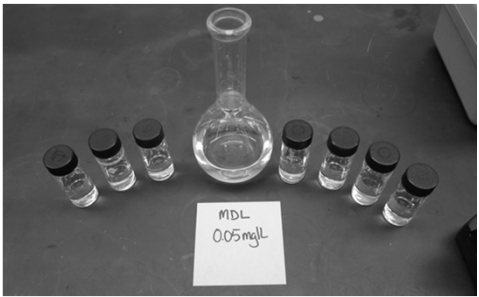

### Dilutions for Today’s Example for MDL

mL Working Standard Diluted w/Deionized water	Chlorine Equivalent mg/L
½ mL (vol. Pipette) to 100 mL (vol. flask)	0.05 mg/L

Don't forget to use DPD on Potassium Permanganate standards

### MDL<sub>s</sub> (Spike)

Date	Analyst	Number	True Value	Value Read	% Recovery (50-150%)
1/17/19	SEP	1	0.05	0.06	120.00
1/17/19	SEP	2	0.05	0.05	100.00
1/18/19	SEP	3	0.05	0.05	100.00
1/18/19	SEP	4	0.05	0.08	160.00
1/19/19	SEP	5	0.05	0.04	80.00
1/19/19	SEP	6	0.05	0.05	100.00
1/19/19	SEP	7	0.05	0.06	120.00
		Standard Deviation		0.01272	
		Spike MDL		0.0400	

### MDL<sub>b</sub> (Blank)

Date	Analyst	Number	Value Read	
1/17/19	SEP	1	0.01	
1/17/19	SEP	2	0.01	
1/18/19	SEP	3	0.02	
1/18/19	SEP	4	0.03	
1/19/19	SEP	5	0.02	
1/19/19	SEP	6	0.00	
1/19/19	SEP	7	nd	
		Blank Standard Deviation		0.01049
		Blank MDL		0.0300

### Method Detection Limit (MDL) Revision 2

- Select the greater of MDL<sub>s</sub> or MDL<sub>b</sub> as the Initial MDL
- In this example, the MDL<sub>s</sub> was greater, so the Initial MDL is 0.0400

### Any Questions?



## Chlorine – Review Questions

### Laboratory Portion:

1. What reagent is used to make Chlorine Calibration Standards?
2. How many Chlorine Calibration Standards are required to create the monthly calibration curve?
3. What type of glassware should be used when creating standard solutions?
4. Potassium Permanganate Solution should be kept in an amber colored bottle and stored in a dark location. True or False?
5. Gel standards can be used to create calibration curves. True or False?
6. Why should you never use plastic containers to store your chlorine calibration standards (or the reagent water that will be used to create them)?
7. With the 2016 revision of the MDL procedure (Revision 2), how often should MDL<sub>s</sub> samples be analyzed? How often should MDL<sub>b</sub> samples be analyzed?
8. How often are you required to re-calculate MDL<sub>s</sub> and MDL<sub>b</sub> from the collected spiked samples and method blank results?

### Classroom Portion:

9. The destruction of all pathogenic microorganisms is called \_\_\_\_\_, which is not to be confused with \_\_\_\_\_, in which all microorganisms (pathogenic **and** nonpathogenic) are destroyed.
10. What is the most important purpose of chlorination at a wastewater treatment plant?
11. How do you determine the Chlorine Dose?





USEPA DPD Method<sup>1</sup>

## Method 8167

0.02 to 2.00 mg/L Cl<sub>2</sub>Powder Pillows or AccuVac<sup>®</sup> Ampuls

**Scope and application:** For testing residual chlorine and chloramines in water, wastewater, estuary water and seawater; USEPA-accepted for reporting for drinking and wastewater analyses.<sup>2</sup> This product has not been evaluated to test for chlorine and chloramines in medical applications in the United States.

<sup>1</sup> Adapted from Standard Methods for the Examination of Water and Wastewater.



<sup>2</sup> Procedure is equivalent to USEPA and Standard Method 4500-Cl G for drinking water and wastewater analysis.

**Test preparation****Instrument-specific information**



Table 1 shows sample cell and orientation requirements for reagent addition tests, such as powder pillow or bulk reagent tests. Table 2 shows sample cell and adapter requirements for AccuVac Ampul tests. The tables also show all of the instruments that have the program for this test.

To use the table, select an instrument, then read across to find the applicable information for this test.

**Table 1 Instrument-specific information for reagent addition**

Instrument	Sample cell orientation	Sample cell
DR 6000 DR 3800 DR 2800 DR 2700 DR 1900	The fill line is to the right.	2495402 
DR 5000 DR 3900	The fill line is toward the user.	
DR 900	The orientation mark is toward the user.	2401906 

**Table 2 Instrument-specific information for AccuVac Ampuls**

Instrument	Adapter	Sample cell
DR 6000 DR 5000 DR 900	—	2427606 
DR 3900	LZV846 (A)	
DR 1900	9609900 or 9609800 (C)	
DR 3800 DR 2800 DR 2700	LZV584 (C)	2122800 

## Before starting

Analyze the samples immediately. The samples cannot be preserved for later analysis.

Install the instrument cap on the DR 900 cell holder before ZERO or READ is pushed.

If the test result is over-range, or if the sample temporarily turns yellow after the reagent addition, dilute the sample with a known volume of high quality, chlorine demand-free water and do the test again. Some loss of chlorine may occur due to the dilution. Multiply the result by the dilution factor. Additional methods are available to measure chlorine without dilution.

For chloramination disinfection control, use one of the available Chloramine (Mono) methods.

For the best results, measure the reagent blank value for each new lot of reagent. Replace the sample with deionized water in the test procedure to determine the reagent blank value. Subtract the reagent blank value from the sample results automatically with the reagent blank adjust option.

Review the Safety Data Sheets (MSDS/SDS) for the chemicals that are used. Use the recommended personal protective equipment.

Dispose of reacted solutions according to local, state and federal regulations. Refer to the Safety Data Sheets for disposal information for unused reagents. Refer to the environmental, health and safety staff for your facility and/or local regulatory agencies for further disposal information.

The SwifTest Dispenser for Total Chlorine can be used in place of the powder pillow in the test procedure. One dispensation is equal to one powder pillow for 10-mL samples.

An AccuVac Ampul for Blanks can be used to zero the instrument in the AccuVac test procedure.

## Items to collect

### Powder pillows

Description	Quantity
DPD Total Chlorine Reagent Powder Pillow, 10-mL	1
Sample cells. (For information about sample cells, adapters or light shields, refer to <a href="#">Instrument-specific information</a> on page 1.)	2

Refer to [Consumables and replacement items](#) on page 6 for order information.

### AccuVac Ampuls

Description	Quantity
DPD Total Chlorine Reagent AccuVac <sup>®</sup> Ampul	1
Beaker, 50-mL	1
Sample cells (For information about sample cells, adapters or light shields, refer to <a href="#">Instrument-specific information</a> on page 1.)	1
Stopper for 18-mm tubes and AccuVac Ampuls	1

Refer to [Consumables and replacement items](#) on page 6 for order information.

## Sample collection

- Analyze the samples immediately. The samples cannot be preserved for later analysis.
- Chlorine is a strong oxidizing agent and is unstable in natural waters. Chlorine reacts quickly with various inorganic compounds and more slowly with organic compounds. Many factors, including reactant concentrations, sunlight, pH, temperature and salinity influence the decomposition of chlorine in water.
- Collect samples in clean glass bottles. Do not use plastic containers because these can have a large chlorine demand.

- Pretreat glass sample containers to remove chlorine demand. Soak the containers in a weak bleach solution (1 mL commercial bleach to 1 liter of deionized water) for at least 1 hour. Rinse fully with deionized or distilled water. If sample containers are rinsed fully with deionized or distilled water after use, only occasional pretreatment is necessary.
- Make sure to get a representative sample. If the sample is taken from a spigot or faucet, let the water flow for at least 5 minutes. Let the container overflow with the sample several times and then put the cap on the sample container so that there is no headspace (air) above the sample.

## Powder pillow procedure

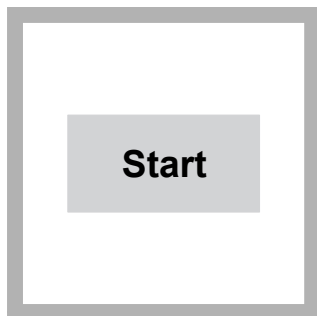

1. Start program **80 Chlorine F&T PP**. For information about sample cells, adapters or light shields, refer to [Instrument-specific information](#) on page 1.

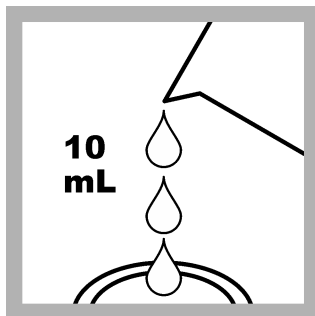

2. Fill a sample cell with 10 mL of sample.

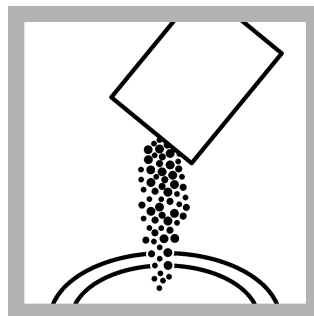

3. **Prepare the sample:** Add the contents of one powder pillow to the sample cell.

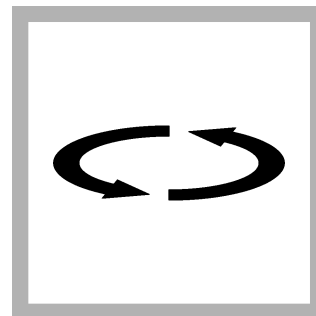

4. Swirl the sample cell for 20 seconds to mix. A pink color shows if chlorine is present in the sample.



5. Start the instrument timer. A 3-minute reaction time starts.

Prepare the sample blank and set the instrument to zero during the reaction time.

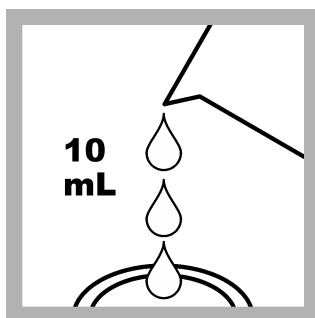

6. **Prepare the blank:** Fill a second sample cell with 10 mL of sample.

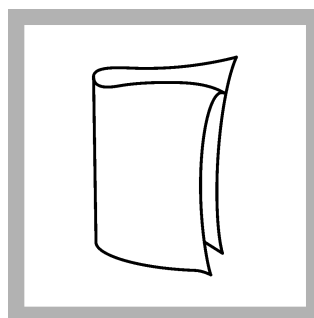

7. Clean the blank sample cell.

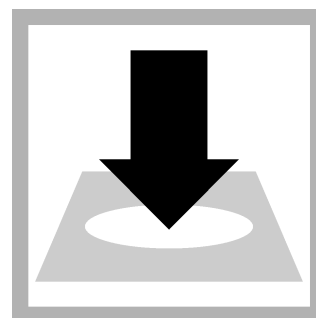

8. Insert the blank into the cell holder.

Zero

9. Push **ZERO**. The display shows 0.00 mg/L Cl<sub>2</sub>.

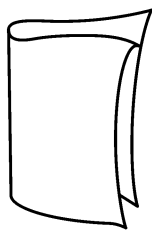

10. Clean the prepared sample cell.

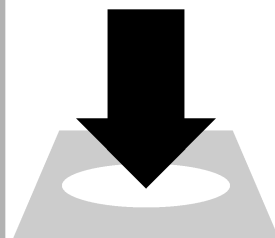

11. Within 3 minutes after the timer expires, insert the prepared sample into the cell holder.

Read

12. Push **READ**. Results show in mg/L Cl<sub>2</sub>.

### AccuVac Ampul procedure

Start

1. Start program **85 Chlorine F&T AV**. For information about sample cells, adapters or light shields, refer to [Instrument-specific information](#) on page 1.

10 mL

2. **Prepare the blank:** Fill the sample cell with 10 mL of sample.

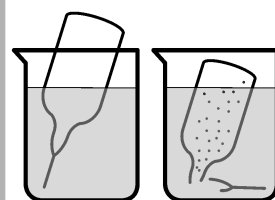

3. **Prepare the sample:** Collect at least 40 mL of sample in a 50-mL beaker. Fill the AccuVac Ampul with sample. Keep the tip immersed while the AccuVac Ampul fills completely.



4. Quickly invert the AccuVac Ampul several times to mix.

03:00

5. Start the instrument timer. A 3-minute reaction time starts.

Prepare the sample blank and set the instrument to zero during the reaction time.

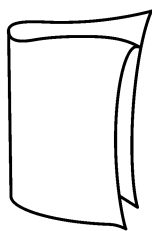

6. Clean the blank sample cell.

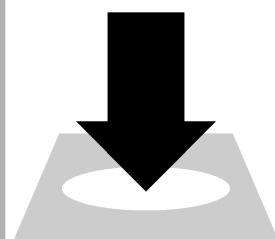

7. Insert the blank into the cell holder.

Zero

8. Push **ZERO**. The display shows 0.00 mg/L Cl<sub>2</sub>.

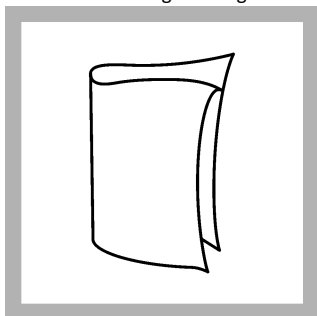

9. Clean the AccuVac Ampul.

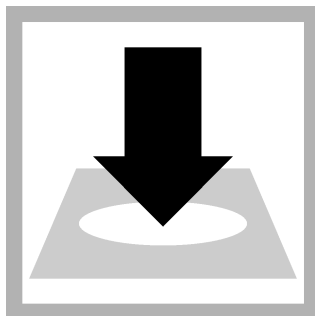

10. Within 3 minutes after the timer expires, insert the prepared sample AccuVac Ampul into the cell holder.

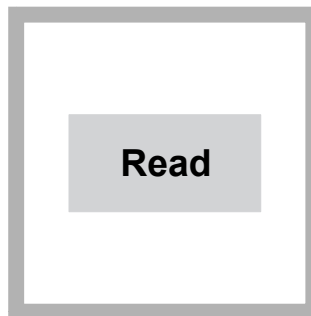

11. Push **READ**. Results show in mg/L  $\text{Cl}_2$ .

## Interferences

Interfering substance	Interference level
Acidity	More than 150 mg/L $\text{CaCO}_3$ . The full color may not develop or the color may fade instantly. Adjust to pH 6–7 with 1 N Sodium Hydroxide. Measure the amount to add on a separate sample aliquot, then add the same amount to the sample that is tested. Correct the test result for the dilution from the volume addition.
Alkalinity	More than 250 mg/L $\text{CaCO}_3$ . The full color may not develop or the color may fade instantly. Adjust to pH 6–7 with 1 N Sulfuric Acid. Measure the amount to add on a separate sample aliquot, then add the same amount to the sample that is tested. Correct the test result for the dilution from the volume addition.
Bromine, $\text{Br}_2$	Positive interference at all levels
Chlorine Dioxide, $\text{ClO}_2$	Positive interference at all levels
Inorganic chloramines	Positive interference at all levels
Chloramines, organic	May interfere in the result for total chlorine analysis
Hardness	No effect at less than 1000 mg/L as $\text{CaCO}_3$
Manganese, Oxidized ( $\text{Mn}^{4+}$ , $\text{Mn}^{7+}$ ) or Chromium, Oxidized ( $\text{Cr}^{6+}$ )	Pre-treat the sample as follows: <ol style="list-style-type: none"> <li>1. Adjust the sample pH to 6–7.</li> <li>2. Add 3 drops of Potassium Iodide (30-g/L) to 10 mL of sample.</li> <li>3. Mix and wait 1 minute.</li> <li>4. Add 3 drops of Sodium Arsenite (5-g/L) and mix.</li> <li>5. Use the test procedure to measure the concentration of the treated sample.</li> <li>6. Subtract this result from the result without the treatment to obtain the correct chlorine concentration.</li> </ol>
Ozone	Positive interference at all levels
Peroxides	May interfere
Highly buffered samples or extreme sample pH	Can prevent the correct pH adjustment (of the sample) by the reagents. Sample pretreatment may be necessary. Adjust to pH 6–7 with acid (Sulfuric Acid, 1.000 N) or base (Sodium Hydroxide, 1.00 N).

## Accuracy check

### Standard additions method (sample spike)

Use the standard additions method (for applicable instruments) to validate the test procedure, reagents and instrument and to find if there is an interference in the sample.

## Items to collect:

- Chlorine Standard Solution, 2-mL PourRite® Ampule, 25–30 mg/L (use mg/L on label)
- Breaker, PourRite Ampules
- Pipet, TenSette®, 0.1–1.0 mL and tips

1. Use the test procedure to measure the concentration of the sample, then keep the (unspiked) sample in the instrument.
2. Go to the Standard Additions option in the instrument menu.
3. Select the values for standard concentration, sample volume and spike volumes.
4. Open the standard solution.
5. Prepare three spiked samples: use the TenSette pipet to add 0.1 mL, 0.2 mL and 0.3 mL of the standard solution, respectively, to three 10-mL portions of fresh sample. Mix well.

**Note:** For AccuVac® Ampuls, add 0.4 mL, 0.8 mL and 1.2 mL of the standard solution to three 50-mL portions of fresh sample.

6. Use the test procedure to measure the concentration of each of the spiked samples. Start with the smallest sample spike. Measure each of the spiked samples in the instrument.
7. Select **Graph** to compare the expected results to the actual results.

**Note:** If the actual results are significantly different from the expected results, make sure that the sample volumes and sample spikes are measured accurately. The sample volumes and sample spikes that are used should agree with the selections in the standard additions menu. If the results are not within acceptable limits, the sample may contain an interference.

## Method performance

The method performance data that follows was derived from laboratory tests that were measured on a spectrophotometer during ideal test conditions. Users can get different results under different test conditions.

Program	Standard	Precision (95% Confidence Interval)	Sensitivity Concentration change per 0.010 Abs change
80	1.25 mg/L Cl <sub>2</sub>	1.23–1.27 mg/L Cl <sub>2</sub>	0.02 mg/L Cl <sub>2</sub>
85	1.25 mg/L Cl <sub>2</sub>	1.21–1.29 mg/L Cl <sub>2</sub>	0.02 mg/L Cl <sub>2</sub>

## Summary of method

Chlorine can be present in water as free chlorine and as combined chlorine. Both forms can exist in the same water and be determined together as total chlorine. Free chlorine is present as hypochlorous acid and/or hypochlorite ion. Combined chlorine exists as monochloramine, dichloramine, nitrogen trichloride and other chloro derivatives. The combined chlorine oxidizes iodide in the reagent to iodine. The iodine and free chlorine react with DPD (N,N-diethyl-p-phenylenediamine) to form a pink color which is proportional to the total chlorine concentration.

To find the concentration of combined chlorine, run a free chlorine test and a total chlorine test. Subtract the results of the free chlorine test from the total chlorine test to obtain the combined chlorine concentration. The measurement wavelength is 530 nm for spectrophotometers or 520 nm for colorimeters.

## Consumables and replacement items

### Required reagents

Description	Quantity/Test	Unit	Item no.
DPD Total Chlorine Reagent Powder Pillow, 10 mL	1	100/pkg	2105669
OR			
DPD Total Chlorine Reagent AccuVac® Ampul	1	25/pkg	2503025

**Required apparatus**

Description	Quantity/Test	Unit	Item no.
AccuVac Snapper	1	each	2405200
Beaker, 50 mL	1	each	50041H
Stoppers for 18-mm tubes and AccuVac Ampuls	2	6/pkg	173106

**Recommended standards**

Description	Unit	Item no.
Chlorine Standard Solution, 10-mL Voluette <sup>®</sup> Ampule, 50–75 mg/L	16/pkg	1426810
Chlorine Standard Solution, 2-mL PourRite <sup>®</sup> Ampules, 50–75 mg/L	20/pkg	1426820
Chlorine Standard Solution, 2-mL PourRite <sup>®</sup> Ampules, 25–30 mg/L	20/pkg	2630020

**Optional reagents and apparatus**

Description	Unit	Item no.
AccuVac <sup>®</sup> Ampul vials for sample blanks	25/pkg	2677925
Ampule Breaker, 2-mL PourRite <sup>®</sup> Ampules	each	2484600
Ampule Breaker, 10-mL Voluette <sup>®</sup> Ampules	each	2196800
Water, Chlorine-demand Free	500 mL	2641549
Mixing cylinder, graduated, 25-mL	each	2088640
Mixing cylinder, graduated, 50 mL	each	189641
DPD Total Chlorine Reagent Powder Pillows, 10 mL	1000/pkg	2105628
DPD Total Chlorine Reagent Powder Pillows, 10 mL	300/pkg	2105603
DPD Total Chlorine Reagent, 10-mL, SwifTest <sup>™</sup> Dispenser refill vial	250 tests	2105660
Paper, pH, 0–14 pH range	100/pkg	2601300
Pipet, TenSette <sup>®</sup> , 0.1–1.0 mL	each	1970001
Pipet tips for TenSette <sup>®</sup> Pipet, 0.1–1.0 mL	50/pkg	2185696
Pipet tips for TenSette <sup>®</sup> Pipet, 0.1–1.0 mL	1000/pkg	2185628
Potassium Iodide, 30-g/L	100 mL	34332
Sodium Arsenite, 5-g/L	100 mL	104732
Sodium Hydroxide Standard Solution, 1.0 N	100 mL MDB	104532
SpecCheck <sup>™</sup> Secondary Standard Kit, Chlorine DPD, 0–2.0 mg/L Set	each	2635300
Sulfuric Acid Standard Solution, 1 N	100 mL MDB	127032
Water, deionized	4 L	27256



**FOR TECHNICAL ASSISTANCE, PRICE INFORMATION AND ORDERING:**  
In the U.S.A. – Call toll-free 800-227-4224  
Outside the U.S.A. – Contact the HACH office or distributor serving you.  
On the Worldwide Web – [www.hach.com](http://www.hach.com); E-mail – [techhelp@hach.com](mailto:techhelp@hach.com)

**HACH COMPANY**  
WORLD HEADQUARTERS  
Telephone: (970) 669-3050  
FAX: (970) 669-2932



**STOCK POTASSIUM PERMANGANATE SOLUTION**  
891 mg in a Liter = 1000 mg/L  
(Stock solution stable for several months)  
Store in amber glass bottle out of sunlight.  
(If precipitate develops, new solution must be prepared.)

**Intermediate  $KMnO_4$  Solution**  
10 mg/L  
(Stable for about one month  
if stored out of light  
and in amber glass bottle.)

**Calibration standards**  
Smaller dilutions used to check  
instrument calibration.  
Good for 8 hours

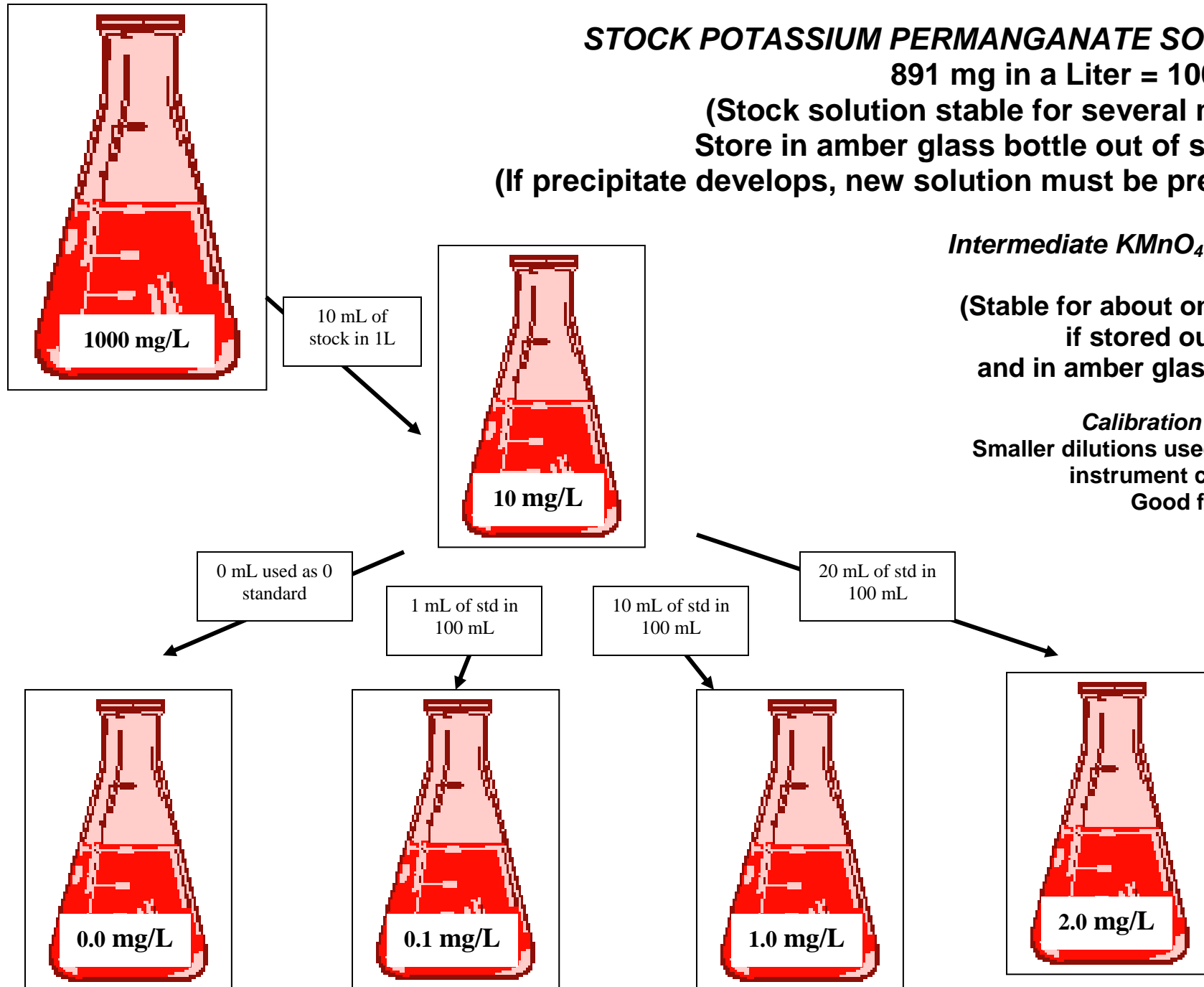

## Chlorine Lab Bench Sheet

### Monthly Calibration Curve:

<b>ml Working Standard Diluted with Deionized Water</b>	<b>Chlorine Equivalent</b>	<b>Actual Reading</b>
20 ml (vol. pipet) to 100 ml (vol. flask)	2.0 mg/L	
10 ml (vol. pipet) to 100 ml (vol. flask)	1.0 mg/L	
5 ml (vol. pipet) to 100 ml (vol. flask)	0.5 mg/L	
1 ml (vol. pipet) to 100 ml (vol. flask)	0.1 mg/L	
0.5 ml (vol. pipet) to 100 ml (vol. flask)	0.05 mg/L	
1 ml (vol. pipet) to 500 ml (vol. flask)	0.02 mg/L	

### Initial MDL Procedure:

<b>Concentration</b>	<b>Actual Reading</b>
0.05 mg/L	
0.05 mg/L	
0.05 mg/L	
0.05 mg/L	
0.05 mg/L	
0.05 mg/L	
0.05 mg/L	

Office of Water

EPA 821-R-16-006

[www.epa.gov](http://www.epa.gov)

December 2016

# Definition and Procedure for the Determination of the Method Detection Limit, Revision 2

This document contains the text of Revision 2 of the method detection limit procedure from 40 CFR 136 Appendix B; but formatted as a more user friendly stand-alone document.

Please address questions or comments to:

CWA Methods Team  
Engineering and Analytical Support Branch/EAD (4303T)  
Office of Science and Technology  
U.S. Environmental Protection Agency  
1200 Pennsylvania Avenue  
Washington, DC 20460

<https://www.epa.gov/cwa-methods>

## DEFINITION AND PROCEDURE FOR THE DETERMINATION OF THE METHOD DETECTION LIMIT REVISION 2

### *Definition*

The method detection limit (MDL) is defined as the minimum measured concentration of a substance that can be reported with 99% confidence that the measured concentration is distinguishable from method blank results.

### *Scope and Application*

The MDL procedure is designed to be a straightforward technique for estimation of the detection limit for a broad variety of physical and chemical methods. The procedure requires a complete, specific, and well-defined analytical method. It is essential that all sample processing steps used by the laboratory be included in the determination of the method detection limit.

The MDL procedure is *not* applicable to methods that do not produce results with a continuous distribution, such as, but not limited to, methods for whole effluent toxicity, presence/absence methods, and microbiological methods that involve counting colonies. The MDL procedure also is *not* applicable to measurements such as, but not limited to, biochemical oxygen demand, color, pH, specific conductance, many titration methods, and any method where low-level spiked samples cannot be prepared. Except as described in the addendum, for the purposes of this procedure, “spiked samples” are prepared from a clean reference matrix, such as reagent water, spiked with a known and consistent quantity of the analyte. MDL determinations using spiked samples may not be appropriate for all gravimetric methods (e.g., residue or total suspended solids), but an MDL based on method blanks can be determined in such instances.

### *Procedure*

- (1) Estimate the initial MDL using one or more of the following:
  - (a) The mean determined concentration plus three times the standard deviation of a set of method blanks.
  - (b) The concentration value that corresponds to an instrument signal-to-noise ratio in the range of 3 to 5.
  - (c) The concentration equivalent to three times the standard deviation of replicate instrumental measurements of spiked blanks.
  - (d) That region of the calibration where there is a significant change in sensitivity, i.e., a break in the slope of the calibration.
  - (e) Instrumental limitations.
  - (f) Previously determined MDL.

It is recognized that the experience of the analyst is important to this process. However, the analyst should include some or all of the above considerations in the initial estimate of the MDL.

## (2) Determine the initial MDL

**Note:** The Initial MDL is used when the laboratory does not have adequate data to perform the Ongoing Annual Verification specified in Section (4), typically when a new method is implemented or if a method was rarely used in the last 24 months.

- (a) Select a spiking level, typically 2 – 10 times the estimated MDL in Section 1. Spiking levels in excess of 10 times the estimated detection limit may be required for analytes with very poor recovery (e.g., for an analyte with 10% recovery, spiked at 100 micrograms/L, with mean recovery of 10 micrograms/L; the calculated MDL may be around 3 micrograms/L. Therefore, in this example, the spiking level would be 33 times the MDL, but spiking lower may result in no recovery at all).
- (b) Process a minimum of seven spiked samples and seven method blank samples through all steps of the method. The samples used for the MDL must be prepared in at least three batches on three separate calendar dates and analyzed on three separate calendar dates. (Preparation and analysis may be on the same day.) Existing data may be used, if compliant with the requirements for at least three batches, and generated within the last twenty four months. The most recent available data for method blanks and spiked samples must be used. Statistical outlier removal procedures should not be used to remove data for the initial MDL determination, since the total number of observations is small and the purpose of the MDL procedure is to capture routine method variability. However, documented instances of gross failures (e.g., instrument malfunctions, mislabeled samples, cracked vials) may be excluded from the calculations, provided that at least seven spiked samples and seven method blanks are available. (The rationale for removal of specific outliers must be documented and maintained on file with the results of the MDL determination.)
  - (i) If there are multiple instruments that will be assigned the same MDL, then the sample analyses must be distributed across all of the instruments.
  - (ii) A minimum of two spiked samples and two method blank samples prepared and analyzed on different calendar dates is required for each instrument. Each analytical batch may contain one spiked sample and one method blank sample run together. A spiked sample and a method blank sample may be analyzed in the same batch, but are not required to be.
  - (iii) The same prepared extract may be analyzed on multiple instruments so long as the minimum requirement of seven preparations in at least three separate batches is maintained.
- (c) Evaluate the spiking level: If any result for any individual analyte from the spiked samples does not meet the method qualitative identification criteria or does not provide a numerical result greater than zero, then repeat the spiked samples at a higher concentration. (Qualitative identification criteria are a set of rules or guidelines for establishing the identification or presence of an analyte using a measurement system. Qualitative identification does not ensure that quantitative results for the analyte can be obtained.)
- (d) Make all computations as specified in the analytical method and express the final results in the method-specified reporting units.
  - (i) Calculate the sample standard deviation (S) of the replicate spiked sample measurements and the sample standard deviation of the replicate method blank measurements from all instruments to which the MDL will be applied.

- (ii) Compute the  $MDL_s$  (the MDL based on spiked samples) as follows:

$$MDL_s = t_{(n-1, 1-\alpha=0.99)} S_s$$

where:

- $MDL_s$  = the method detection limit based on spiked samples  
 $t_{(n-1, 1-\alpha=0.99)}$  = the Student's  $t$ -value appropriate for a single-tailed 99<sup>th</sup> percentile  $t$  statistic and a standard deviation estimate with  $n-1$  degrees of freedom. See Addendum Table 1.  
 $S_s$  = sample standard deviation of the replicate spiked sample analyses.

- (iii) Compute the  $MDL_b$  (the MDL based on method blanks) as follows:

- (A) If none of the method blanks give numerical results for an individual analyte, the  $MDL_b$  does not apply. A numerical result includes both positive and negative results, including results below the current MDL, but not results of "ND" (not detected) commonly observed when a peak is not present in chromatographic analysis.
- (B) If some (but not all) of the method blanks for an individual analyte give numerical results, set the  $MDL_b$  equal to the highest method blank result. If more than 100 method blanks are available, set  $MDL_b$  to the level that is no less than the 99<sup>th</sup> percentile of the method blank results. For "n" method blanks where  $n \geq 100$ , sort the method blanks in rank order. The  $(n * 0.99)$  ranked method blank result (round to the nearest whole number) is the  $MDL_b$ . For example, to find  $MDL_b$  from a set of 164 method blanks where the highest ranked method blank results are ... 1.5, 1.7, 1.9, 5.0, and 10, then  $164 * 0.99 = 162.36$  which rounds to the 162nd method blank result. Therefore,  $MDL_b$  is 1.9 for  $n=164$  (10 is the 164th result, 5.0 is the 163rd result, and 1.9 is the 162nd result). Alternatively, you may use spreadsheet algorithms to calculate the 99<sup>th</sup> percentile to interpolate between the ranks more precisely.
- (C) If all of the method blanks for an individual analyte give numerical results, then calculate the  $MDL_b$  as:

$$MDL_b = \bar{X} + t_{(n-1, 1-\alpha=0.99)} S_b$$

where:

- $MDL_b$  = the MDL based on method blanks  
 $\bar{X}$  = mean of the method blank results (use zero in place of the mean if the mean is negative)  
 $t_{(n-1, 1-\alpha=0.99)}$  = the Student's  $t$ -value appropriate for the single-tailed 99<sup>th</sup> percentile  $t$  statistic and a standard deviation estimate with  $n-1$  degrees of freedom. See Addendum Table 1.  
 $S_b$  = sample standard deviation of the replicate method blank sample analyses.

**Note:** If 100 or more method blanks are available, as an option,  $MDL_b$  may be set to the concentration that is greater than or equal to the 99th percentile of the method blank results, as described in Section (2)(d)(iii)(B).

- (e) Select the greater of  $MDL_s$  or  $MDL_b$  as the initial MDL.

### (3) Ongoing Data Collection

- (a) During any quarter in which samples are being analyzed, prepare and analyze a minimum of two spiked samples on each instrument, in separate batches, using the same spiking concentration used in Section 2. If any analytes are repeatedly not detected in the quarterly spiked sample analyses, or do not meet the qualitative identification criteria of the method (see Section 2(c) of this procedure), then this is an indication that the spiking level is not high enough and should be adjusted upward. Note that it is not necessary to analyze additional method blanks together with the spiked samples, the method blank population should include all of the routine method blanks analyzed with each batch during the course of sample analysis.
- (b) Ensure that at least seven spiked samples and seven method blanks are completed for the annual verification. If only one instrument is in use, a minimum of seven spikes are still required, but they may be drawn from the last two years of data collection.
- (c) At least once per year, re-evaluate the spiking level.
  - (i) If more than 5% of the spiked samples do not return positive numerical results that meet all method qualitative identification criteria, then the spiking level must be increased and the initial MDL re-determined following the procedure in Section 2.
- (d) If the method is altered in a way that can be reasonably expected to change its sensitivity, then re-determine the initial MDL according to Section 2, and restart the ongoing data collection.
- (e) If a new instrument is added to a group of instruments whose data are being pooled to create a single MDL, analyze a minimum of two spiked replicates and two method blank replicates on the new instrument. If both method blank results are below the existing MDL, then the existing MDL<sub>b</sub> is validated. Combine the new spiked sample results to the existing spiked sample results and recalculate the MDL<sub>s</sub> as in Section 4. If the recalculated MDL<sub>s</sub> does not vary by more than the factor specified in Section 4(f) of this procedure, then the existing MDL<sub>s</sub> is validated. If either of these two conditions is not met, then calculate a new MDL following the instructions in Section 2.

### (4) Ongoing Annual Verification

- (a) At least once every thirteen months, re-calculate MDL<sub>s</sub> and MDL<sub>b</sub> from the collected spiked samples and method blank results using the equations in Section 2.
- (b) Include data generated within the last twenty four months, but only data with the same spiking level. Only documented instances of gross failures (e.g., instrument malfunctions, mislabeled samples, cracked vials) may be excluded from the calculations. (The rationale for removal of specific outliers must be documented and maintained on file with the results of the MDL determination.) If the laboratory believes the sensitivity of the method has changed significantly, then the most recent data available may be used, maintaining compliance with the requirement for at least seven replicates in three separate batches on three separate days (see Section 2b).
- (c) Include the initial MDL spiked samples, if the data were generated within twenty four months.
- (d) Only use data associated with acceptable calibrations and batch QC. Include all routine data, with the exception of batches that are rejected and the associated samples reanalyzed. If the method has been altered in a way that can be reasonably expected to change its sensitivity, then use only data collected after the change.



- (e) Ideally, use all method blank results from the last 24 months for the MDL<sub>b</sub> calculation. The laboratory has the option to use only the last six months of method blank data or the fifty most recent method blanks, whichever criteria yields the greater number of method blanks.
- (f) The verified MDL is the greater of the MDL<sub>s</sub> or MDL<sub>b</sub>. If the verified MDL is within 0.5 to 2.0 times the existing MDL, and fewer than 3% of the method blank results (for the individual analyte) have numerical results above the existing MDL, then the existing MDL may optionally be left unchanged. Otherwise, adjust the MDL to the new verification MDL. (The range of 0.5 to 2.0 approximates the 95<sup>th</sup> percentile confidence interval for the initial MDL determination with six degrees of freedom.)

#### ADDENDUM: DETERMINATION OF THE MDL FOR A SPECIFIC MATRIX

The MDL may be determined in a specific sample matrix as well as in reagent water.

- (1) Analyze the sample matrix to determine the native (background) concentration of the analyte(s) of interest.
- (2) If the response for the native concentration is at a signal-to-noise ratio of approximately 5-20, determine the matrix-specific MDL according to Section 2 but without spiking additional analyte.
- (3) Calculate MDL<sub>b</sub> using the method blanks, not the sample matrix.
- (4) If the signal-to-noise ratio is less than 5, then the analyte(s) should be spiked into the sample matrix to obtain a concentration that will give results with a signal-to-noise ratio of approximately 10-20.
- (5) If the analytes(s) of interest have signal-to-noise ratio(s) greater than approximately 20, then the resulting MDL is likely to be biased high.

**Table 1: Single-Tailed 99<sup>th</sup> Percentile *t* Statistic**

Number of replicates	Degrees of freedom (n-1)	<i>t</i> <sub>(n-1, 0.99)</sub>
7	6	3.143
8	7	2.998
9	8	2.896
10	9	2.821
11	10	2.764
16	15	2.602
21	20	2.528
26	25	2.485
31	30	2.457
32	31	2.453
48	47	2.408
50	49	2.405
61	60	2.390
64	63	2.387
80	79	2.374
96	95	2.366
100	99	2.365

***Documentation***

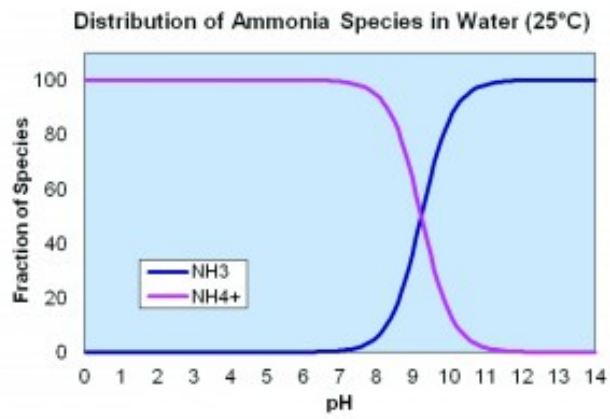

The analytical method used must be specifically identified by number or title and the MDL for each analyte expressed in the appropriate method reporting units. Data and calculations used to establish the MDL must be able to be reconstructed upon request. The sample matrix used to determine the MDL must also be identified with MDL value. Document the mean spiked and recovered analyte levels with the MDL. The rationale for removal of outlier results, if any, must be documented and maintained on file with the results of the MDL determination.

## Section 4 Ammonia



# Ammonia Nitrogen

Wastewater Lab

TDEC - Fleming Training Center 1

## What is Ammonia?

- Ammonia is one of several forms of nitrogen that exist in aquatic environments
- Contains Nitrogen and Hydrogen
- It exists as 2 species:
  - Un-ionized Ammonia (NH<sub>3</sub>)
  - Ionized Ammonia (NH<sub>4</sub>)
- Total Ammonia is the sum of both NH<sub>3</sub> and NH<sub>4</sub>

TDEC - Fleming Training Center 2

## Where does it come from?

- Natural sources:
  - Decomposition or breakdown of organic waste matter
  - Gas exchange with the atmosphere
  - Forest fires
  - Animal and human waste
  - Nitrogen fixation processes
- Commercial fertilizers
- Industrial applications

TDEC - Fleming Training Center 3

## Ammonia Nitrogen

- In domestic wastewater, conc. is generally between 10-40 mg/L.
- Primary treatment may increase the ammonia nitrogen slightly due to the composition of some protein compounds during treatment

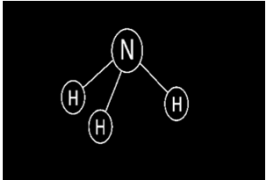

TDEC - Fleming Training Center 4

## Ammonia Nitrogen

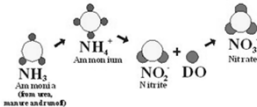

○ = Nitrogen  
 ● = Hydrogen  
 ⊕ = Dissolved Oxygen

- During secondary treatment processes, ammonia may be oxidized to nitrite then to nitrate in varying degrees depending on factors such as wastewater temperature, residence time of the microorganisms and oxygen amounts.

TDEC - Fleming Training Center 5

## Nitrification – The reaction



- $2\text{NH}_3 + \text{HCO}_3^- + 3\text{O}_2 \xrightarrow{\text{Nitrosomonas}} 2\text{HNO}_2 + 4\text{H}_2\text{O} + 2\text{CO}_2$   
 (bicarbonate) (nitrous acid)
- $2\text{HNO}_2 + \text{O}_2 + 2\text{HCO}_3^- \xrightarrow{\text{Nitrobacter}} 2\text{NO}_3^- + 2\text{H}_2\text{O} + 2\text{CO}_2$

The Nitrobacter microorganisms use the nitrite in nitrous acid oxidizing it to nitrate.

TDEC - Fleming Training Center 6

## Ammonia Nitrogen

- Ammonia levels can
  - Increase chlorine demand
  - Cause fish toxicity
    - Un-ionized form  $\text{NH}_3$  is highly toxic to fish and aquatic life
    - Higher pH = more  $\text{NH}_3$
    - Higher temps = more  $\text{NH}_3$
  - Increase oxygen demand on receiving water

TDEC - Fleming Training Center 7

## Forms of Nitrogen in Activated Sludge

<ul style="list-style-type: none"> <li>□ Un-Oxidized Forms of Nitrogen                             <ul style="list-style-type: none"> <li>■ Nitrogen Gas (<math>\text{N}_2</math>)</li> <li>■ Ammonia</li> <li>■ Organic Nitrogen including proteins, amino acids, urea, etc..</li> </ul> </li> </ul>	→	<ul style="list-style-type: none"> <li>□ Oxidized Forms of Nitrogen                             <ul style="list-style-type: none"> <li>■ Nitrite</li> <li>■ Nitrate</li> <li>■ Nitrous Oxide</li> </ul> </li> </ul>
---	---	---

TDEC - Fleming Training Center 8

## More on Nitrogen in Activated Sludge

- Total Nitrogen =  $\text{TKN} + \text{NO}_2 + \text{NO}_3$
- TKN (Total Kjeldahl Nitrogen) =  $\text{NH}_3 + \text{Organic Nitrogen}$
- Rule of thumb:
  - Ammonia makes up approximately 60% of TKN
  - Organic Nitrogen is typically removed in settled sludge
  - TKN makes up approximately 15% - 20% of the total influent BOD.

TDEC - Fleming Training Center 9

## Why Nitrify?

- Ammonia can be harmful if discharged.
  - Creates dissolved oxygen sag in receiving stream
  - Toxic to fish and other aquatic life
  - Possible problem for downstream water supplies.
  - Nutrient input (when oxidized).



**Toxic to Fish and Aquatic Life**

TDEC - Fleming Training Center 10

## Some Ammonia Effects

Ammonia Levels & Effects	
$\text{NH}_3$ Levels	Effects
0.06 mg/L	Fish can suffer gill damage
0.1 mg/L	Usually indicative of polluted waters
0.2 mg/L	Sensitive fish like trout and salmon begin to die
2.0 mg/L	Ammonia-tolerant fish, like carp, begin to die

The danger ammonia poses for fish depends on the water's temperature and pH. The higher the pH and temperature, the more toxic the ammonia.

TDEC - Fleming Training Center 11

## Sources of Ammonia In Wastewater

- Incoming Raw Wastewater (domestic waste)
- Internal Recycle (anaerobic digester supernatant, belt press filtrate) - high
- Septage (high)
- Industrial Sources



TDEC - Fleming Training Center 12

## How Much Ammonia ???

- Typically, expect influent domestic wastewater to have 25 – 30 mg/l of  $\text{NH}_3\text{-N}$
- Considered Strong if  $> 50\text{mg/l}$   $\text{NH}_3\text{-N}$
- Septage 150 mg/l



TDEC - Fleming Training Center

13

## Sample Collection

- Collect samples in glass or plastic containers
- Fill sample bottle completely
- If chlorine is present, treat with sodium thiosulfate  $\text{Na}_2\text{S}_2\text{O}_3$ 
  - Add one drop of 0.1N sodium thiosulfate solution for every 0.35 mg/L of chlorine present (ISE method 10001 by Hach)

TDEC - Fleming Training Center

14

## Sample Collection

- Analyze as soon as possible
  - Refrigerate at  $6^\circ\text{C}$  for samples to be analyzed within 24 hours
  - If this is not possible, preserve the sample with sulfuric acid to  $\text{pH} < 2$  and store at  $6^\circ\text{C}$ .
    - Samples acidified and cooled may be stored for 28 days
- Before analysis, neutralize the sample to  $\text{pH} 7$  with 5N sodium hydroxide (ISE method 10001 by Hach)

TDEC - Fleming Training Center

15

## Procedural Concerns

- Ammonia distillation apparatus should be steamed out
- A high & low standard should be carried through the ammonia distillation



TDEC - Fleming Training Center

16

## Procedural Concerns

- Distillate is caught in boric acid solution for titration or ~~nesslerization~~
  - Nesslerization has been dropped as a standard method
- Distillate is caught in  $0.04\text{N}$   $\text{H}_2\text{SO}_4$  if using the **probe method**
  - 4500-NH3 D. Ammonia Selective Electrode Method

TDEC - Fleming Training Center

17

## Probe Method (4500-NH<sub>3</sub> D)

- The ammonia electrode measures ammonia gas or ammonium ions in aqueous solutions that have been converted to gas by the addition of a strong base.
- The electrode is a complete electrochemical cell consisting of a glass pH electrode and a reference electrode.
- The gas-permeable membrane separates the sample from a thin layer of electrolyte that is pressed between the pH bulb and the membrane.

TDEC - Fleming Training Center

18

## Probe Method (4500-NH<sub>3</sub> D)

- ❑ At high pH, ammonium ion is converted to ammonia gas.
- ❑ The gas diffuses through the membrane and causes a pH change in the thin layer of electrolyte.
- ❑ The potential across the pH glass changes as a result of the pH change and the electrode measures the change in potential.
- ❑ The measured pH change is proportional to the ammonia concentration in the solution.

TDEC - Fleming Training Center

19

## Ammonia SM4500-NH<sub>3</sub> D-2011

- ❑ 136 Table 1B
  - “Manual Distillation<sup>6</sup> or gas diffusion, followed by any of the following...”
  - Footnote #6
    - ❑ Comparability Study
    - ❑ Follow Standard Methods
- ❑ See page 40,857 of the 136 Rule, Footnote #6



TDEC - Fleming Training Center

20

## Ammonia SM4500-NH<sub>3</sub> D-2011

- ❑ 4500-NH3 A-2011: “Methods D, E, F, G, and H may be used either with or without sample distillation.”
- ❑ 4500-NH3 D.1.b. -2011: “Sample distillation is unnecessary.”
- ❑ See Footnote 6 in 40 CFR 136 Table 1B

TDEC - Fleming Training Center

21

## 40 CFR 136 Table 1B

- ❑ Footnote 6 – “Manual distillation is not required if comparability data on representative effluent samples are on file to show that this preliminary distillation step is not necessary; however, manual distillation will be required to resolve any controversies. In general, the analytical method should be consulted regarding the need for distillation. If the method is not clear, the laboratory may compare a minimum of 9 different sample matrices to evaluate the need for distillation. For each matrix, a matrix spike and matrix spike duplicate are analyzed both with and without the distillation step. (A total of 36 samples, assuming 9 matrices). If results are comparable, the laboratory may dispense with the distillation step for future analysis. Comparable is defined as < 20% RPD for all tested matrices). Alternatively the two populations of spike recovery percentages may be compared using a recognized statistical test.”

22

## Ammonia SM4500-NH<sub>3</sub> D -2011

- ❑ Standard Methods
  - 4500-NH3 A.1 – In general, direct manual determination of low concentrations of ammonia is confined to drinking waters, clean surface or groundwater and good-quality nitrified wastewater effluent.
- ❑ Tennessee recommends that one sample is run yearly to compare the distilled and undistilled results and that the results are within 20% of each other.
  - Note – if distilled sample and undistilled sample are below detection limit, you cannot calculate the percent difference.

TDEC - Fleming Training Center

23

## Ammonia SM4500-NH<sub>3</sub> D -2011

- ❑ DOC
- ❑ MDL
- ❑ LRB
- ❑ LFB
- ❑ LFM/LFMD
- ❑ ICAL/CCV
- ❑ Control Charts
- ❑ Corrective Action
- ❑ QC Acceptance
- ❑ Batch Size
- ❑ QC Frequency



TDEC - Fleming Training Center

24

## Ammonia SM4500-NH<sub>3</sub> D -2011

- Demonstration of Capability (DOC)
  - Run a laboratory-fortified blank (LFB) at least four times and compare to the limits listed in the method
    - No limits listed for ammonia
  - Real people language: each operator running this test need to analyze 4 samples of an Ammonia Standard at a concentration around 1.0 mg/L.
  - Documentation (signed form) that analyst has read and understands all appropriate SOPs and Methods.
  - Recommend backup analyst do this once a year.

TDEC - Fleming Training Center

25

## Ammonia SM4500-NH<sub>3</sub> D -2011

- Method Detection Limit (MDL)
- Review EPA's "Definition and Procedure for the Determination of the Method Detection Limit, Revision 2"
  1. Estimate Initial MDL
  2. Determine Initial MDL
    - Process a minimum of 7 spiked samples and 7 method blanks through all steps of the method
      - Must be prepared in at least 3 batches on 3 separate calendar dates and analyzed on 3 separate calendar dates
        - Existing data may be used, if compliant with above requirements, generated within the last 24 months

26

## Ammonia SM4500-NH<sub>3</sub> D -2011

- Method Detection Limit (MDL)
  - Determine Initial MDL continued...
    - If there are multiple instruments assigned the same MDL, then sample analyses must be distributed across all the instruments
    - A minimum of 2 spiked samples and 2 method blanks prepared and analyzed for each instrument
  - Evaluate the spiking level
  - Calculate MDL<sub>s</sub> and MDL<sub>b</sub>
  - Select the greater of MDL<sub>s</sub> or MDL<sub>b</sub> as Initial MDL

TDEC - Fleming Training Center

27

## Ammonia SM4500-NH<sub>3</sub> D -2011

- Method Detection Limit (MDL)
  3. Ongoing Data Collection
    - During any quarter in which samples are being analyzed, prepare and analyze a min. of 2 MDL<sub>s</sub> on each instrument, in separate batches, with same spike concentration as Initial MDL
    - Use routine method blanks as MDL<sub>b</sub>
    - At least once a year, re-evaluate the spiking level
  4. Ongoing Annual Verification
    - At least once every 13 months, recalculate MDLs and MDLb
    - Include data generated within last 24 months
      - Only data with same spiking level
      - Include initial MDL spiked samples, if within 24 months
      - Use all method blanks from last 24 months\*
      - The verified MDL is the greater of the MDL<sub>s</sub> or MDL<sub>b</sub>

28

## Ammonia SM4500-NH<sub>3</sub> D -2011

- Method Blank
  - Real people language: analyze distilled water as a sample by going through distillation (if you still distill samples) and using ISA (ion strength adjuster)
    - Target value is less than MDL (reporting limit)
    - Run on a 5% basis, one for every 20 samples
- Laboratory Fortified Blank
  - Real people language: analyze an ammonia standard at a concentration around 5 mg/L
    - Run on a 5% basis (see batch size for more information).

TDEC - Fleming Training Center

29

## Ammonia SM4500-NH<sub>3</sub> D -2011

- Lab fortified matrix and duplicate (spike& spike dup)
- Real people language – add a known amount of ammonia to a sample and expect that amount to be added to your sample concentration and repeat process for LFMD.
  - Run on a 5% basis (see batch size for more information).
  - Calculate RPD between spiked sample and spiked duplicate, target value should be close to the first value and have a small RPD (less than 20%).
  - **2014 Update** - Spike volume should be less than 1% of the volume.
    - Example: spike with 1 mL of 1000 mg/L into 100 mL sample will equal a 10 mg/L increase in ammonia concentration.

TDEC - Fleming Training Center

30



## Ammonia SM4500-NH<sub>3</sub> D -2011

- Initial Calibration
  - Standards that bracket the expected concentrations
  - Standards should not exceed an order of magnitude such as 1,10,100,1000
  - Real people language: calibrate probe daily (day of) with at least 3 standards
  - **2014 Update** – analyze a 10 mg/L standard as a sample after calibration and before samples to verify initial calibration (ICV)
- Calibration Verification
  - Real people language: analyze 10 mg/L at the end of samples daily (day of) to verify calibration is still valid

TDEC - Fleming Training Center

31

## Ammonia SM4500-NH<sub>3</sub> D -2011

- **2014 Update** - Create and maintain control charts if you have 20-30 QC data points within 90 days.
  - If you do not meet the above criteria, follow QC Acceptance Criteria below.
    - Blanks < MDL
    - LFB ± 15%
    - ICV/CCV ± 10%
    - LFM/LFMD ± 20%
    - RPD < 20%
    - Reporting limit = MDL

TDEC - Fleming Training Center

32

Any Questions?

TDEC - Fleming Training Center

33

## Ammonia – Review Questions

### Laboratory portion:

1. What is the purpose of the “steaming out equipment preparation” in the Preliminary Distillation Step?
2. What are the 2 major factors that influence selection of the method to determine ammonia?
3. When is the preliminary distillation required?
4. Why does a sample need to be dechlorinated? And what chemical would you use to dechlorinate the sample?
5. How do you preserve an Ammonia sample and what is the maximum holding time after preservation (according to 40 CFR 136)?
6. Which methods did we use in class to determine Ammonia concentration?
7. Analysis using the ammonia-selective electrode method (aka “the probe method”) requires that the distillate be captured in what type of acid receiving solution?
8. List the correct order of steps to properly perform the complete Ammonia Preliminary Distillation Step?
9. During the Preliminary Distillation Step, we caught our distilled sample (or distillate) into 50 mL of 0.04N H<sub>2</sub>SO<sub>4</sub> (sulfuric acid). Using the  $C_1V_1 = C_2V_2$  formula, determine how many mL of 0.1N H<sub>2</sub>SO<sub>4</sub> is needed to make 100 mL of 0.04N H<sub>2</sub>SO<sub>4</sub>

Classroom portion:

10. Which form of ammonia is the most toxic to fish? Under what conditions is that form most prevalent
  
11. Write out the names of the following chemical formulas associated with Ammonia Nitrogen:
  - $\text{NH}_4$
  - $\text{NH}_3$
  - $\text{NO}_2$
  - $\text{NO}_3$
  - $\text{N}_2$
  
12. Elevated ammonia levels can lead to what problems?
  
13. Why is ammonia harmful if discharged into receiving waters?
  
14. What is ammonia oxidized into during the nitrification process?
  
15. What is the most efficient way to remove Nitrate from your system?
  
16. Total Nitrogen is made up of what?
  
17. TKN stands for what? TKN includes what forms of nitrogen?
  
18. The ammonia electrode measures ammonia gas or ammonium ions in aqueous solutions that have been converted to gas. How are they converted into the gas form?
  
19. Footnote number 6 in 40 CFR 136 (Table 1B) contains important information regarding distillation in the ammonia analysis. Briefly describe or summarize what that footnote says.

## 4500-NH<sub>3</sub> NITROGEN (AMMONIA)\*

### 4500-NH<sub>3</sub> A. Introduction

#### 1. Selection of Method

The two major factors that influence selection of the method to determine ammonia are concentration and presence of interferences. In general, direct manual determination of low concentrations of ammonia is confined to drinking waters, clean surface or groundwater, and good-quality nitrified wastewater effluent. In other instances, and where interferences are present or greater precision is necessary, a preliminary distillation step (4500-NH<sub>3</sub>.B) is required.

A titrimetric method (4500-NH<sub>3</sub>.C), an ammonia-selective electrode method (4500-NH<sub>3</sub>.D), an ammonia-selective electrode method using known addition (4500-NH<sub>3</sub>.E), a phenate method (4500-NH<sub>3</sub>.F), and two automated versions of the phenate method (4500-NH<sub>3</sub>.G and H) are presented. Methods 4500-NH<sub>3</sub>.D, E, F, G, and H may be used either with or without sample distillation. The data presented in Tables 4500-NH<sub>3</sub>.I and III should be helpful in selecting the appropriate method of analysis.

Nesslerization has been dropped as a standard method, although it has been considered a classic water quality measurement for more than a century. The use of mercury in this test warrants its deletion because of the disposal problems.

The distillation and titration procedure is used especially for NH<sub>3</sub>-N concentrations greater than 5 mg/L. Use boric acid as the absorbent following distillation if the distillate is to be titrated.

The ammonia-selective electrode method is applicable over the range from 0.03 to 1400 mg NH<sub>3</sub>-N/L.

The manual phenate method is applicable to both fresh water and seawater and is linear to 0.6 mg NH<sub>3</sub>-N/L. Distill into sulfuric acid (H<sub>2</sub>SO<sub>4</sub>) absorbent for the phenate method when interferences are present.

\* Approved by Standard Methods Committee, 1997. Editorial revisions, 2011. Joint Task Group: 20th Edition (4500-NH<sub>3</sub>.H)—Scott Stieg (chair), Bradford R. Fisher, Owen B. Mathre, Theresa M. Wright.

The automated phenate method is applicable over the range of 0.02 to 2.0 mg NH<sub>3</sub>-N/L.

#### 2. Interferences

Glycine, urea, glutamic acid, cyanates, and acetamide hydrolyze very slowly in solution on standing but, of these, only urea and cyanates will hydrolyze on distillation at pH of 9.5. Hydrolysis amounts to about 7% at this pH for urea and about 5% for cyanates. Volatile alkaline compounds, such as hydrazine and amines, will influence titrimetric results. Residual chlorine reacts with ammonia; remove by sample pretreatment. If a sample is likely to contain residual chlorine, immediately upon collection, treat with dechlorinating agent as in 4500-NH<sub>3</sub>.B.3d.

#### 3. Storage of Samples

Most reliable results are obtained on fresh samples. If samples are to be analyzed within 24 h of collection, refrigerate unacidified at 4°C. For preservation for up to 28 d, freeze at -20°C unacidified, or preserve samples by acidifying to pH <2 and storing at 4°C. If acid preservation is used, neutralize samples with NaOH or KOH immediately before making the determination. **CAUTION: Although acidification is suitable for certain types of samples, it produces interferences when exchangeable ammonium is present in unfiltered solids.**

#### 4. Bibliography

- THAYER, G.W. 1970. Comparison of two storage methods for the analysis of nitrogen and phosphorus fractions in estuarine water. *Chesapeake Sci.* 11:155.
- SALLEY, B.A., J.G. BRADSHAW & B.J. NELSON. 1986. Results of Comparative Studies of Preservation Techniques for Nutrient Analysis on Water Samples. Virginia Institute of Marine Science, Gloucester Point.

### 4500-NH<sub>3</sub> B. Preliminary Distillation Step

#### 1. General Discussion

The sample is buffered at pH 9.5 with a borate buffer to decrease hydrolysis of cyanates and organic nitrogen compounds. It is distilled into a solution of boric acid when titration is to be used or into H<sub>2</sub>SO<sub>4</sub> when the phenate method is used. The ammonia in the distillate can be determined either colorimetrically by the phenate method or titrimetrically with standard H<sub>2</sub>SO<sub>4</sub> and a mixed indicator or a pH meter. The choice between

the colorimetric and the acidimetric methods depends on the concentration of ammonia. Ammonia in the distillate also can be determined by the ammonia-selective electrode method, using 0.04N H<sub>2</sub>SO<sub>4</sub> to trap the ammonia.

#### 2. Apparatus

*a. Distillation apparatus:* Arrange a borosilicate glass flask of 800- to 2000-mL capacity attached to a vertical condenser so the

outlet tip may be submerged below the surface of the receiving acid solution. Use an all-borosilicate-glass apparatus or one with condensing units constructed of block tin or aluminum tubes.

b. *pH meter.*

### 3. Reagents

a. *Ammonia-free water:* Prepare by ion-exchange or distillation methods:

1) Ion exchange—Prepare ammonia-free water by passing distilled water through an ion-exchange column containing a strongly acidic cation-exchange resin mixed with a strongly basic anion-exchange resin. Select resins that will remove organic compounds that interfere with the ammonia determination. Some anion-exchange resins tend to release ammonia. If this occurs, prepare ammonia-free water with a strongly acidic cation-exchange resin. Regenerate the column according to the manufacturer's instructions. Check ammonia-free water for the possibility of a high blank value.

2) Distillation—Eliminate traces of ammonia in distilled water by adding 0.1 mL conc H<sub>2</sub>SO<sub>4</sub> to 1 L distilled water and redistilling. Alternatively, treat distilled water with sufficient bromine or chlorine water to produce a free halogen residual of 2 to 5 mg/L and redistill after standing at least 1 h. Discard the first 100 mL distillate. Check redistilled water for the possibility of a high blank.

It is very difficult to store ammonia-free water in the laboratory without contamination from gaseous ammonia. However, if storage is necessary, store in a tightly stoppered glass container to which is added about 10 g ion-exchange resin (preferably a strongly acidic cation-exchange resin)/L ammonia-free water. For use, let resin settle and decant ammonia-free water. If a high blank value is produced, replace the resin or prepare fresh ammonia-free water.

Use ammonia-free distilled water for preparing all reagents, rinsing, and sample dilution.

b. *Borate buffer solution:* Add 88 mL 0.1N NaOH solution to 500 mL approximately 0.025M sodium tetraborate (Na<sub>2</sub>B<sub>4</sub>O<sub>7</sub>) solution (9.5 g Na<sub>2</sub>B<sub>4</sub>O<sub>7</sub> · 10 H<sub>2</sub>O/L) and dilute to 1 L.

c. *Sodium hydroxide, 6N.*

d. *Dechlorinating reagent:* Dissolve 3.5 g sodium thiosulfate (Na<sub>2</sub>S<sub>2</sub>O<sub>3</sub> · 5H<sub>2</sub>O) in water and dilute to 1 L. Prepare fresh weekly. Use 1 mL reagent to remove 1 mg/L residual chlorine in 500-mL sample.

e. *Neutralization agent.*

1) *Sodium hydroxide (NaOH), 1N.*

2) *Sulfuric acid (H<sub>2</sub>SO<sub>4</sub>), 1N.*

f. *Absorbent solution, plain boric acid:* Dissolve 20 g H<sub>3</sub>BO<sub>3</sub> in water and dilute to 1 L.

g. *Indicating boric acid solution:* See 4500-NH<sub>3</sub>.C.3a and b.

h. *Sulfuric acid, 0.04N:* Dilute 1.0 mL conc H<sub>2</sub>SO<sub>4</sub> to 1 L.

### 4. Procedure

a. *Equipment preparation:* Add 500 mL water and 20 mL borate buffer, adjust pH to 9.5 with 6N NaOH solution, and add to a distillation flask. Add a few glass beads or boiling chips and use this mixture to steam out the distillation apparatus until distillate shows no traces of ammonia.

b. *Sample preparation:* Use 500 mL dechlorinated sample or a known portion diluted to 500 mL with water. When NH<sub>3</sub>-N concentration is less than 100 µg/L, use a sample volume of 1000 mL. Remove residual chlorine by adding, at the time of collection, dechlorinating agent equivalent to the chlorine residual. If necessary, neutralize to approximately pH 7 with dilute acid or base, using a pH meter.

Add 25 mL borate buffer solution and adjust to pH 9.5 with 6N NaOH using a pH meter.

c. *Distillation:* To minimize contamination, leave distillation apparatus assembled after steaming out and until just before starting sample distillation. Disconnect steaming-out flask and immediately transfer sample flask to distillation apparatus. Distill at a rate of 6 to 10 mL/min with the tip of the delivery tube below the surface of acid receiving solution. Collect distillate in a 500-mL Erlenmeyer flask containing 50 mL indicating boric acid solution for titrimetric method. Distill ammonia into 50 mL 0.04N H<sub>2</sub>SO<sub>4</sub> for the ammonia-selective electrode method and for the phenate method. Collect at least 200 mL distillate. Lower distillation receiver so the end of the delivery tube is free of contact with the liquid and continue distillation during the last minute or two to cleanse condenser and delivery tube. Dilute to 500 mL with water.

When the phenate method is used for determining NH<sub>3</sub>-N, neutralize distillate with 1N NaOH solution.

d. *Ammonia determination:* Determine ammonia by the titrimetric method (4500-NH<sub>3</sub>.C), the ammonia-selective electrode methods (4500-NH<sub>3</sub>.D and E), or the phenate methods (4500-NH<sub>3</sub>.F and G).

### 5. Bibliography

- NICHOLS, M.S. & M.E. FOOTE. 1931. Distillation of free ammonia from buffered solutions. *Ind. Eng. Chem., Anal. Ed.* 3:311.
- GRIFFIN, A.E. & N.S. CHAMBERLIN. 1941. Relation of ammonia nitrogen to breakpoint chlorination. *Amer. J. Pub. Health* 31:803.
- PALIN, A.T. 1950. Symposium on the sterilization of water. Chemical aspects of chlorination. *J. Inst. Water Eng.* 4:565.
- TARAS, M.J. 1953. Effect of free residual chlorination of nitrogen compounds in water. *J. Amer. Water Works Assoc.* 45:47.

4500-NH<sub>3</sub> D. Ammonia-Selective Electrode Method

## 1. General Discussion

*a. Principle:* The ammonia-selective electrode uses a hydrophobic gas-permeable membrane to separate the sample solution from an electrode internal solution of ammonium chloride. Dissolved ammonia (NH<sub>3(aq)</sub> and NH<sub>4</sub><sup>+</sup>) is converted to NH<sub>3(aq)</sub> by raising pH to above 11 with a strong base. NH<sub>3(aq)</sub> diffuses through the membrane and changes the internal solution pH that is sensed by a pH electrode. The fixed level of chloride in the internal solution is sensed by a chloride ion-selective electrode that serves as the reference electrode. Potentiometric measurements are made with a pH meter having an expanded millivolt scale or with a specific ion meter.

*b. Scope and application:* This method is applicable to the measurement of 0.03 to 1400 mg NH<sub>3</sub>-N/L in potable and surface waters and domestic and industrial wastes. High concentrations of dissolved ions affect the measurement, but color and turbidity do not. Sample distillation is unnecessary. Use standard solutions and samples that have the same temperature and contain about the same total level of dissolved species. The ammonia-selective electrode responds slowly below 1 mg NH<sub>3</sub>-N/L; hence, use longer times of electrode immersion (2 to 3 min) to obtain stable readings.

*c. Interference:* Amines are a positive interference. This may be enhanced by acidification. Mercury and silver interfere by complexing with ammonia, unless the NaOH/EDTA solution (3c) is used.

*d. Sample preservation:* Refrigerate at 4°C for samples to be analyzed within 24 h. Preserve samples high in organic and nitrogenous matter, and any other samples for longer storage, by lowering pH to 2 or less with conc H<sub>2</sub>SO<sub>4</sub>.

*e. Quality control (QC):* The QC practices considered to be an integral part of each method are summarized in Table 4020:I.

## 2. Apparatus

*a. Electrometer:* A pH meter with expanded millivolt scale capable of 0.1 mV resolution between -700 mV and +700 mV or a specific ion meter.

*b. Ammonia-selective electrode.*

*c. Magnetic stirrer,* thermally insulated, with TFE-coated stirring bar.

## 3. Reagents

*a. Ammonia-free water:* See 4500-NH<sub>3</sub>.B.3a. Use for making all reagents.

*b. Sodium hydroxide, 10N.*

*c. NaOH/EDTA solution, 10N:* Dissolve 400 g NaOH in 800 mL water. Add 45.2 g ethylenediaminetetraacetic acid, tetrasodium salt, tetrahydrate (Na<sub>4</sub>EDTA · 4 H<sub>2</sub>O) and stir to dissolve. Cool and dilute to 1000 mL.

*d. Stock ammonium chloride solution:* Dissolve 3.819 g anhydrous NH<sub>4</sub>Cl (dried at 100°C) in water, and dilute to 1000 mL; 1.00 mL = 1.00 mg N = 1.22 mg NH<sub>3</sub>.

*e. Standard ammonium chloride solutions:* See 4500-NH<sub>3</sub>.D.4a.

## 4. Procedure

*a. Preparation of standards:* Prepare a series of standard solutions covering the concentrations of 1000, 100, 10, 1, and 0.1 mg NH<sub>3</sub>-N/L by making decimal dilutions of stock NH<sub>4</sub>Cl solution with water.

*b. Electrometer calibration:* Place 100 mL of each standard solution in a 150-mL beaker. Immerse electrode in standard of lowest concentration and mix with a magnetic stirrer. Limit stirring speed to minimize possible loss of ammonia from the solution. Maintain the same stirring rate and a temperature of about 25°C throughout calibration and testing procedures. Add a sufficient volume of 10N NaOH solution (1 mL usually is sufficient) to raise pH above 11. If the presence of silver or mercury is possible, use NaOH/EDTA solution in place of NaOH solution. If it is necessary to add more than 1 mL of either NaOH or NaOH/EDTA solution, note volume used, because it is required for subsequent calculations. Keep electrode in solution until a stable millivolt reading is obtained. Do not add NaOH solution before immersing electrode, because ammonia may be lost from a basic solution. Repeat procedure with remaining standards, proceeding from lowest to highest concentration. Wait until the reading has stabilized (at least 2 to 3 min) before recording millivolts for standards and samples containing ≤1 mg NH<sub>3</sub>-N/L.

*c. Preparation of standard curve:* Using semilogarithmic graph paper, plot ammonia concentration in milligrams NH<sub>3</sub>-N per liter on the log axis vs. potential in millivolts on the linear axis, starting with the lowest concentration at the bottom of the scale. If the electrode is functioning properly, a tenfold change of NH<sub>3</sub>-N concentration produces a potential change of about 59 mV.

*d. Calibration of specific ion meter:* Refer to manufacturer's instructions and proceed as in §§ a and b above.

*e. Measurement of samples:* Dilute if necessary to bring NH<sub>3</sub>-N concentration to within calibration curve range. Place 100 mL sample in 150-mL beaker and follow procedure in § b above. Record volume of 10N NaOH added. Read NH<sub>3</sub>-N concentration from standard curve.

## 5. Calculation

$$\text{mg NH}_3\text{-N/L} = A \times B \times \left[ \frac{100 + D}{100 + C} \right]$$

where:

*A* = dilution factor,

*B* = concentration of NH<sub>3</sub>-N/L, mg/L, from calibration curve,

*D* = volume of 10N NaOH added to sample, mL, and

*C* = volume of 10N NaOH added to calibration standards, mL.

## 6. Precision and Bias

For the ammonia-selective electrode in a single laboratory using surface water samples at concentrations of 1.00, 0.77, 0.19, and 0.13 mg NH<sub>3</sub>-N/L, standard deviations were ±0.038, ±0.017, ±0.007, and ±0.003, respectively. In a single laboratory using surface water samples at concentrations of 0.10 and 0.13 mg NH<sub>3</sub>-N/L, recoveries were 96% and 91%, respectively.

TABLE 4500-NH<sub>3</sub>:I. PRECISION AND BIAS OF AMMONIA-SELECTIVE ELECTRODE

Level mg/L	Matrix	Mean Recovery %	Precision	
			Overall % RSD	Single Operator % RSD
0.04	Distilled water	200	125	25
	Effluent water	100	75	0
0.10	Distilled water	180	50	10
	Effluent water	470	610	10
0.80	Distilled water	105	14	5
	Effluent water	105	38	7.5
20	Distilled water	95	10	5
	Effluent water	95	15	10
100	Distilled water	98	5	2
	Effluent water	97	—	—
750	Distilled water	97	10.4	1.6
	Effluent water	99	14.1	1.3

SOURCE: AMERICAN SOCIETY FOR TESTING & MATERIALS. Standard Test Methods for Ammonia Nitrogen in Water; Method 1426-79. Philadelphia, Pa.

The results of an interlaboratory study involving 12 laboratories using the ammonia-selective electrode on distilled water and effluents are summarized in Table 4500-NH<sub>3</sub>:I.

## 7. Bibliography

- BANWART, W.L., J.M. BREMNER & M.A. TABATABAI. 1972. Determination of ammonium in soil extracts and water samples by an ammonia electrode. *Comm. Soil Sci. Plant Anal.* 3:449.
- MIDGLEY, C. & K. TERRANCE. 1972. The determination of ammonia in condensed steam and boiler feed-water with a potentiometric ammonia probe. *Analyst* 97:626.
- BOOTH, R.L. & R.F. THOMAS. 1973. Selective electrode determination of ammonia in water and wastes. *Environ. Sci. Technol.* 7:523.
- U.S. ENVIRONMENTAL PROTECTION AGENCY. 1979. Methods for Chemical Analysis of Water and Wastes; EPA-600/4-79-020. National Environmental Research Center, Cincinnati, Ohio.
- AMERICAN SOCIETY FOR TESTING & MATERIALS. 1979. Standard Test Methods for Ammonia Nitrogen in Water; Method 1426-79. Philadelphia, Pa.

## 4500-NH<sub>3</sub> E. Ammonia-Selective Electrode Method Using Known Addition

### 1. General Discussion

*a. Principle:* When a linear relationship exists between concentration and response, known addition is convenient for measuring occasional samples because no calibration is needed. Because an accurate measurement requires that the concentration at least double as a result of the addition, sample concentration must be known within a factor of three. Total concentration of ammonia can be measured in the absence of complexing agents down to 0.8 mg NH<sub>3</sub>-N/L or in the presence of a large excess (50 to 100 times) of complexing agent. Known addition is a convenient check on the results of direct measurement.

*b.* See 4500-NH<sub>3</sub>.D.1 for further discussion.

*c. Quality control (QC):* The QC practices considered to be an integral part of each method are summarized in Table 4020:I.

### 2. Apparatus

Use apparatus specified in 4500-NH<sub>3</sub>.D.2.

### 3. Reagents

Use reagents specified in 4500-NH<sub>3</sub>.D.3.

Add standard ammonium chloride solution approximately 10 times as concentrated as samples being measured.

### 4. Procedure

*a.* Dilute 1000 mg/L stock solution to make a standard solution about 10 times as concentrated as the sample concentrate.

*b.* Add 1 mL 10N NaOH to each 100 mL sample and immediately immerse electrode. When checking a direct measure-

ment, leave electrode in 100 mL of sample solution. Use magnetic stirring throughout. Measure mV reading and record as  $E_1$ .

*c.* Pipet 10 mL of standard solution into sample. Thoroughly stir and immediately record new mV reading as  $E_2$ .

### 5. Calculation

*a.*

$$\Delta E = E_1 - E_2.$$

*b.* From Table 4500-NH<sub>3</sub>:II find the concentration ratio,  $Q$ , corresponding to change in potential,  $\Delta E$ . To determine original total sample concentration, multiply  $Q$  by the concentration of the added standard:

$$C_o = QC_s$$

where:

$C_o$  = total sample concentration, mg/L,  
 $Q$  = reading from known-addition table, and  
 $C_s$  = concentration of added standard, mg/L.

*c.* To check a direct measurement, compare results of the two methods. If they agree within  $\pm 4\%$ , the measurements probably are good. If the known-addition result is much larger than the direct measurement, the sample may contain complexing agents.

### 6. Precision and Bias

In 38 water samples analyzed by both the phenate and the known-addition ammonia-selective electrode method, the elec-



# 4500-NH<sub>3</sub> B-1997 (2011) Preliminary Distillation Step for Ammonia Electrode Method

TDEE Training Center

## Reagents Needed:

- 1) 0.1 N NaOH
- 2) 0.025M sodium tetraborate solution (Na<sub>2</sub>B<sub>4</sub>O<sub>7</sub>)  
To make: add 9.5 gm Na<sub>2</sub>B<sub>4</sub>O<sub>7</sub>·10 H<sub>2</sub>O and dilute to 1 Liter)
- 3) Borate buffer solution:  
To make: add 88 mL 0.1N NaOH solution to 500 mL ~0.025M sodium tetraborate (Na<sub>2</sub>B<sub>4</sub>O<sub>7</sub>) solution and dilute to 1Liter
- 4) 6N NaOH
- 5) 0.04N H<sub>2</sub>SO<sub>4</sub>  
To make: add 1.0 mL conc H<sub>2</sub>SO<sub>4</sub> and dilute to 1 Liter

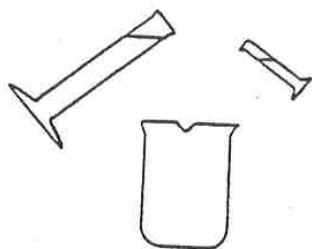

## Steaming out equipment preparation:

- Add 500 mL water and 20 mL Borate buffer solution into 1000 mL beaker
- Adjust pH to 9.5 with 6N NaOH solution
- Add mixture to distillation flask
- Add 3-4 glass beads
- Use this mixture to steam out the distillation apparatus
- Maintain gentle boiling at a rate of 6 to 10 mL/minute
- Continue until ammonia-free
- Collect about 350mL of distillate



## Sample preparation:

1. Add 500 mL **dechlorinated** sample or a known portion diluted to 500 mL with water to 1000 mL beaker  
(When NH<sub>3</sub>-N concentration is less than 10 micrograms, use a sample volume of 1000 mL.)
2. Add 25 mL borate buffer solution to beaker
3. Adjust to pH 9.5 with 6N NaOH using a pH meter.

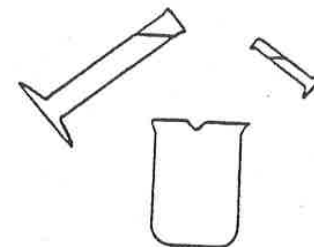

## Distillation:

Leave apparatus assembled following steaming out and until just before starting sample distillation.

1. Maintain gentle boiling at a rate of 6 to 10 mL/minute with tip of the delivery tube below the surface of acid receiving solution.
2. Collect distillate in 500-mL erlenmeyer flask containing **50 mL of 0.04N H<sub>2</sub>SO<sub>4</sub>** for ammonia-selective electrode method
3. **Collect at least 200mL distillate.** Lower the distillation receiver to free delivery tube of contact with liquid
4. Continue distillation during the last minute or two to cleanse condenser and delivery tube.
5. **Dilute to 500 mL with water.**

Use **4500-NH<sub>3</sub> D - (2011)** to determine ammonia concentration.

(Applicable concentration range from 0.03 to 1400 mg NH<sub>3</sub>-N/L)



## Ammonia Probe: Model ISENH318101 or ISENH318103

### Safety information

#### Precautionary labels

Read all labels and tags attached to the instrument. Personal injury or damage to the instrument could occur if not observed. A symbol on the instrument is referenced in the manual with a precautionary statement.



Electrical equipment marked with this symbol may not be disposed of in European public disposal systems after 12 August of 2005. In conformity with European local and national regulations (EU Directive 2002/96/EC), European electrical equipment users must now return old or end-of-life equipment to the Producer for disposal at no charge to the user.

**Note:** For return for recycling, please contact the equipment producer or supplier for instructions on how to return end-of-life equipment, producer-supplied electrical accessories, and all auxiliary items for proper disposal.

### Specifications

**Note:** Specifications are subject to change without notice.

Specifications	Details
Probe type	Digital combination gas-sensing probe with a refillable outer body, double-junction reference and a built-in temperature sensor
Range	0.01 mg/L ( $5 \times 10^{-7}$ M) to 14,000 mg/L (1 M) as $\text{NH}_3\text{-N}$
Sample pH range	> pH 11 per Ammonia ISA
Linear region	0.5 mg/L to 14,000 mg/L as $\text{NH}_3\text{-N}$
Slope	57 mV/decade (90 to 110% in linear range at 25 °C (77 °F) per Nernstian theoretical value)
Operating temperature range	5 to 50 °C (41 to 122 °F)
Storage temperature range	5 to 35 °C (41 to 95 °F)
Junction	Double junction (annular)
Reference type	Ag/AgCl
Fill solution	3 M KCl gel (non-refillable), 0.1 M $\text{NH}_4\text{Cl}$ (outer body, refillable)
Membrane	Replaceable Hach ISENH3181 Ammonia membrane module
Response time in linear region	< 60 seconds (application dependent)
Minimum sample volume	15 mL
Minimum immersion depth	25.4 mm (1 in.)
Dimensions	Diameter: 12 mm (0.47 in.) Length: 175 mm (6.89 in.) Cable length: 1 or 3 m (3.28 or 9.84 ft)
Cable connection	M12 digital output and connector compatible with HQd meters

### Product overview

The ISENH318101 or ISENH318103 probe is a digital combination gas-sensing electrode with a refillable outer body, double-junction reference and built-in temperature sensor (Figure 1). The probe is available with a 1 or 3 m (3.28 or 9.84 ft) cable and is intended for laboratory use. The probe measures ammonia concentration in water samples.

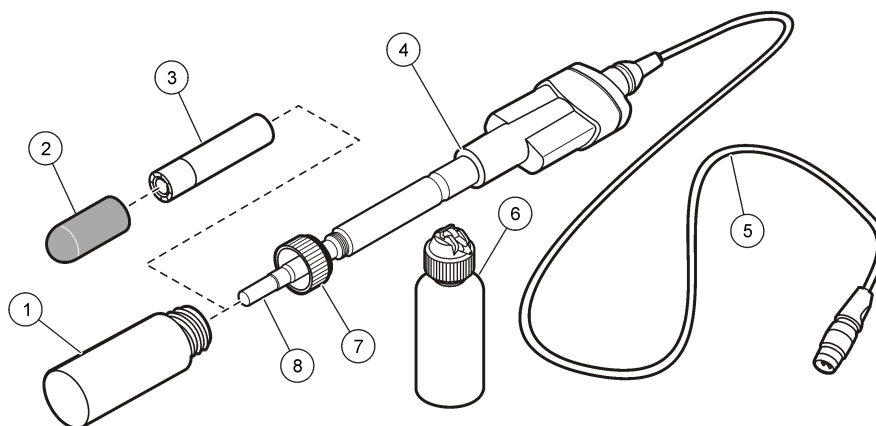
**Figure 1 Probe overview**

1 Soaker bottle	5 1 or 3 m (3.28 or 9.84 ft) cable
2 Membrane module protector cap (3x)	6 Fill solution bottle
3 Membrane module (3x)	7 Soaker bottle lid
4 Probe body	8 Glass bulb with integrated temperature sensor

## Preparation for use

Prepare the probe for use before calibration or sample measurement.

1. Twist and remove the soaker bottle from the lid to release the pressure.
2. Remove the soaker bottle lid from the probe.
3. Rinse the probe with deionized water. Blot dry with a lint-free cloth. Do not touch the tip of the probe.
4. Get a single membrane module from the shipping package. Do not touch the membrane surface.
5. Add 12 drops (0.5 mL) of the Ammonia probe filling solution in the membrane module.
6. Install the membrane module on the probe and tighten. Do not spill the filling solution.

## Calibration

### Before calibration:

The probe must have the correct service-life time stamp. Set the date and time in the meter before the probe is attached.

It is not necessary to recalibrate when moving a calibrated probe from one HQd meter to another if the additional meter is configured to use the same calibration options.

Default calibration standard set for ISENH3181 probe requires 1, 10 and 100 mg/L Ammonia standard solutions. A new method can be made if custom calibration or measurement settings are needed. Refer to [Advanced operation](#) on page 7 for a list of additional calibration sets.

To view the current calibration, push **↵**, select View Probe Data, then select View Current Calibration.

If any two probes are connected, push the **UP** or **DOWN** arrow to change to the single display mode in order to show the Calibrate option.

Make sure the Ammonia membrane module is assembled with the correct amount of Ammonia fill solution.

Prepare the probe for use (refer to [Preparation for use](#) on page 2).

**Calibration notes:**

- Stir the standards and samples at a slow and steady rate to prevent the formation of a vortex.
- Additional standard sets along with the minimum number of calibration points can be selected on the Calibration Options menu.
- Push **Skip** to omit a standard from the calibration routine. The display will not show Skip until the minimum number of standards is met.
- Begin with the lowest concentration during calibration. This reduces carry-over contamination to give the best results.
- Note the temperatures of the standards during calibration. Keep temperatures between calibration standards within  $\pm 2$  °C for optimal results.
- The calibration is recorded in the electrode and the data log. The calibration is also sent to a PC, printer or flash memory stick if connected.
- Air bubbles under the sensor tip when submerged can cause slow response or error in measurement. If bubbles are present, gently shake the probe until bubbles are removed.
- If a calibration error occurs, refer to [Troubleshooting](#) on page 11.

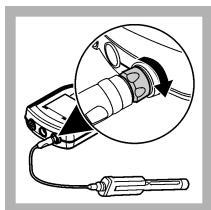
**Calibration procedure:**

1. Connect the probe to the meter. Make sure that the cable locking nut is securely connected to the meter. Turn the meter on.

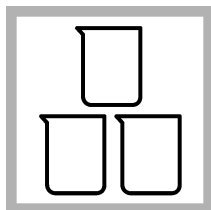

2. In three separate beakers or appropriate containers, prepare Ammonia standard solutions (minimum 25 mL volume).

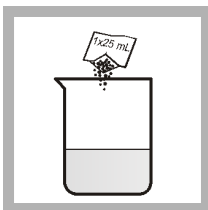

3. Add the contents of one Ammonia ionic strength adjustment (ISA) powder pillow per 25 mL to each standard.



4. Push **Calibrate**. The display shows the current standard value that is to be read from the standard solution set.

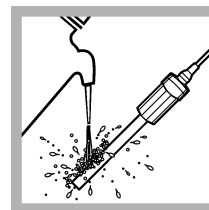

5. Rinse the probe with deionized water. Blot dry with a lint-free cloth. Do not touch the tip of the probe.

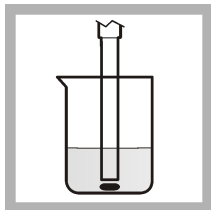

6. Add a stir bar and put the probe in the first standard solution in the set. Do not put the probe on the bottom or sides of the container.

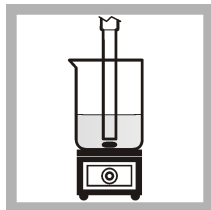

7. Put the beaker on an electromagnetic stirrer and stir at a moderate rate. Check for air bubbles and remove them if necessary.



8. Push **Read**. The display will highlight the standard value and proceed to the next standard value. The display will show "Stabilizing" and a progress bar as the reading stabilizes. The display shows the standard value when the reading is stable.

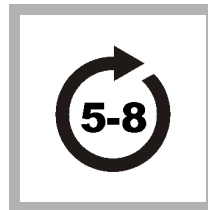

9. Repeat steps 5-8 for the other Ammonia standard solutions in the set.



10. Push **Done** to view the calibration summary. The display will not show Done until the minimum number of calibration points have been collected.



11. Push **Store** to accept the calibration and return to the measurement mode.

## Measurement—direct method

### Before measurement:

The probe must have the correct service-life time stamp. Set the date and time in the meter before the probe is attached.

If complete traceability is required, enter a sample ID and operator ID before measurement. Refer to the HQd meter manual for more information.

Make sure the Ammonia membrane module is assembled with the correct amount of Ammonia fill solution.

Regular calibration is required for the best measurement accuracy (refer to [Calibration](#) on page 2).

Prepare the probe for use (refer to [Preparation for use](#) on page 2).

### Measurement notes:

- Stir the standards and samples at a slow and steady rate to prevent the formation of a vortex.
- Stabilization times with smaller concentration changes generally will be longer and can be minimized by proper stirring and conditioning. Experiment to determine the proper stir rate if necessary.

- The integrated temperature sensor and HQd meter software do not compensate for differences in temperature between calibration standards and samples. Measurement stabilization is not dependent on temperature stabilization. Temperatures of calibration standards and samples should be kept within  $\pm 2$  °C of each other for optimal results.
- Data is automatically stored in the data log when **Press to Read** or **Interval** is selected in the Measurement Mode. When **Continuous** is selected, data will only be stored when **Store** is selected.
- Between measurements, rinse the probe with deionized water. Blot dry with a lint-free cloth. Do not touch the tip of the probe.
- Air bubbles under the sensor tip when submerged can cause slow response or error in measurement. If bubbles are present, gently shake the probe until bubbles are removed.
- If a measurement error occurs, refer to [Troubleshooting](#) on page 11.

#### Measurement procedure:

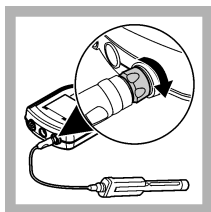

1. Connect the probe to the meter. Make sure that the cable locking nut is securely connected to the meter. Turn the meter on.

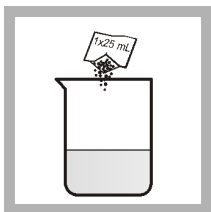

2. Prepare a minimum of 25 mL of the sample(s) in beakers or appropriate containers. Add the contents of one Ammonia ionic strength adjustment (ISA) powder pillow per 25 mL to each sample.

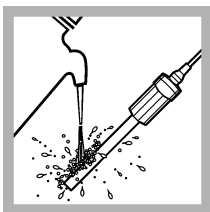

3. Rinse the probe with deionized water. Blot dry with a lint-free cloth. Do not touch the tip of the probe.

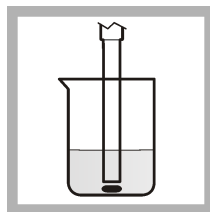

4. Add a stir bar and put the probe in the sample. Do not put the probe on the bottom or sides of the container.

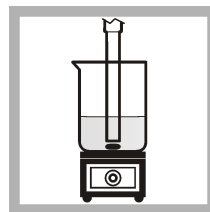

5. Put the beaker on an electromagnetic stirrer and stir at a moderate rate. Check for air bubbles and remove them if necessary.



6. Push **Read**. The display will show "Stabilizing" and a progress bar as the probe stabilizes in the sample. The display will show the lock icon when the reading stabilizes.

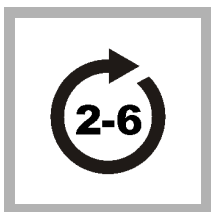

7. Repeat steps 2 - 6 for additional measurements.

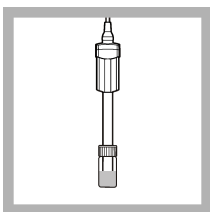

8. When measurements are done, store the probe (refer to [Storage](#) on page 10).

## Interferences

The sensing element responds to ammonia as well as other ions. Typically, probe response to another ion increases the potential, and causes a positive error. The response to other ions can be semi-quantitatively determined through the Nikolsky equation, an extended Nernst equation:

$$E = E^{\circ} + (RT/(zF))\ln[aN_a + KN_{ax} \times ax]$$

Where

- $ax$ —the activity of the interfering ion
- $KN_{ax}$ —the selectivity coefficient for the interfering ion relative to chloride

Volatile amines interfere with Ammonia ISE measurement. Most gases do not interfere as they are converted to ionic form in basic solutions. Ionic species cannot cross the gas-permeable membrane and are not direct electrode interferences. However, the level of ions in solution can change the solubility of ammonia. Standards and samples should have about the same level of ions and dissolved species.

Ammonia forms metal complexes with a number of metal ions: mercury, silver, copper, gold, nickel, cobalt, cadmium and zinc. At pH >11, most of these metals form hydroxide complexes or precipitate. The Ammonia ISA adjusts the pH to >11. When hydroxide is present at the 0.1 M level and the ammonia concentration is below  $10^{-3}$  M, only mercury will appreciably complex ammonia. The total ammonia level of the sample will be measured if the mercury in the sample is preferentially bound to some other species. Iodide is recommended for this purpose, since it forms a soluble mercury complex at all pH levels. Use of Ammonia ISA inhibits the formation of some common metal complexes in the sample because it contains a high concentration of hydroxide ion.

## Run a check standard

The run check standard feature validates instrument performance between sample measurements. Use the run check standard feature for periodic or user-defined interval measurements of a traceable standard solution. Set the criteria for check standards from the ISENH3181 Settings menu.

**Note:** Access control must be off or a valid password must be entered before any of the check standard method options can be changed.

1. Push . The Full Access Options menu is shown.
2. Select Run Check Standard.  
**Note:** Select the correct probe if two probes are connected to the meter.
3. Prepare the standard solution shown on the display. Add one powder pillow per 25 mL of standard solution.
4. Put the probe in the standard solution and push **Read**. The display will show "Stabilizing" and a progress bar as the reading stabilizes. The display shows the value of the check standard and either Check Standard Passed or Check Standard Failed.
5. If the display shows **Check Standard Passed**, the check standard measurement is within the accepted limits set by the administrative user. Select **Done** to continue with the sample measurement.
6. If the display shows **Check Standard Failed**, the measurement is outside of accepted limits set by the administrative user and a recalibration is recommended. If the acceptance criteria is set to Cal Expires on Failure: Yes, the display shows the calibration icon and a question mark until the probe is recalibrated. To correct the probe calibration and status indicator, calibrate the probe (refer to [Calibration](#) on page 2).

## Advanced operation

Parameter-specific settings can be changed through the Full Access Options menu. Details about menu navigation, available options and how to change them are given in the screens, tables and procedures throughout this section.



The settings that can be changed are shown in [Table 1](#).

**Table 1 Parameter-specific settings**

Setting	Options
Measurement Options	<ul style="list-style-type: none"> <li>• Units</li> <li>• Significant digits</li> <li>• Auto stabilization</li> <li>• Stability criteria</li> <li>• Upper and lower range limits</li> </ul>
Calibration Options	<ul style="list-style-type: none"> <li>• Standard set</li> <li>• Calibration units</li> <li>• Minimum calibration points</li> <li>• Slope limit</li> <li>• Calibration reminder</li> </ul>
Check Standard Options	<ul style="list-style-type: none"> <li>• Standard</li> <li>• Check standard reminder</li> <li>• Acceptance criteria</li> </ul>

### Change measurement options

Methods are groups of factory-set or user-defined settings relevant to specific applications. If the meter is set to a factory-set method and the Modify Current Settings option is chosen, a prompt for a new name is shown after the changes are entered. The settings are saved with this name to distinguish them from the factory-set methods, which cannot be changed. A saved method can be used instead of multiple adjustments to the individual settings. Changes made to a user-defined method are automatically saved with the existing name. Multiple methods can be saved for the same probe on each meter.

1. Make sure a probe is connected to the meter.
2. Push and select ISENH3181 Settings.
3. Select Modify Current Settings.
4. Select Measurement Options and update the settings:

Option	Description
<b>Chemical Form</b>	Sets the concentration value—NH <sub>3</sub> or NH <sub>3</sub> -N.
<b>Units</b>	Sets the preferred unit for ISE measurements—mg/L (default), µg/L, g/L, g/kg, mol/L, mmol/L, mol/kg, %, ppm or ppb. <i>Note: The mV units are shown when the detailed display is selected.</i>
<b>Significant Digits</b>	Sets the significant digits shown—2, 3 (default) or 4.

Option	Description
<b>Auto Stabilization</b>	Sets auto stabilization—on (default) or off. The default stability drift rate is 1.0 mV/min.
<b>Stability Criteria</b>	When Auto Stabilization is off, sets the stability criteria—0.1 to 9.9 mV/min. <ul style="list-style-type: none"> <li>Lower stability criteria will require longer stabilization times, but the measurement will be more precise.</li> <li>Higher stability criteria will require shorter stabilization times, but the measurements may be less precise.</li> </ul>
<b>Measurement Limits</b>	Sets the measurement limits—Lower limit (default: 0.01 mg/L) or Upper limit (default: 14,000 mg/L).  The measurement limits can be set to match the acceptable values for the sample. When the measurement is above the upper limit setting or below the lower limit setting, the meter shows an "Out of limits" message. This message is an alert to a potential problem with the process conditions.

- If prompted, enter a name for the new method settings. Additional changes made to the settings of an existing method are automatically saved with the same method name.
- Push **EXIT** until the meter returns to the measurement mode.

## Change calibration options

- Make sure a probe is connected to the meter.
- Push  and select ISENH3181 Settings.
- Select Modify Current Settings.
- Select Calibration Options and update the settings:

Option	Description
<b>Std Set</b>	Sets the temperature compensated standard sets that are used for calibration— <ul style="list-style-type: none"> <li>1, 10 or 100 mg/L as NH<sub>3</sub>-N</li> <li>10, 100 or 1000 mg/L as NH<sub>3</sub>-N</li> <li>1, 10, 100 or 1000 mg/L as NH<sub>3</sub>-N</li> </ul> <p>Standard set values are shown on the Calibration Options screen. Custom standard sets are characterized at 25 °C (77 °F). Custom standard values are not temperature compensated. Select the Custom buffer to make a custom standard. Up to five standard values can be made (refer to <a href="#">Table 2</a>).</p> <p><b>Note:</b> Only the minimum calibration points must be measured for Done to be shown on the calibration screen.</p>
<b>Chemical Form</b>	Sets the chemical form.
<b>Calibration Units</b>	Sets the preferred unit for ISE Calibration—mg/L (default), µg/L (available only for custom calibration set), g/L, g/kg, mol/L, mmol/L, mol/kg, %, ppm or ppb.
<b>Std Set Values</b>	When Std Set is set to Custom, sets the standard set values (refer to <a href="#">Table 2</a> ).  Up to five standard values can be made. Each standard value can include a standard set value, Custom or No Standard.



Option	Description
<b>Minimum Cal Points</b>	Sets the minimum number of calibration points necessary before a calibration can be completed—2 or 3.
<b>Slope Limit</b>	Sets the slope limit—1 to 30% (acceptable slope criteria, default = 15%). The slope must fall within set limits for successful calibration.

5. Select Calibration Reminder and update the settings:

Option	Description
<b>Reminder Repeat</b>	Meter will make an audible sound when a calibration is due and repeat the sound at the selected interval—Off (default), 2 h, 4 h, 8 h, 2 d, 5 d or 7 d.
<b>Expires</b>	Calibration expires after the selected time—Immediately, Reminder + 30 min (default), Reminder + 1 h, Reminder + 2 h or Continue Reading. <i>Note: The meter cannot be used to read samples after calibration has expired unless Continue Reading is selected.</i>

6. If prompted, enter a name for the new method settings. Additional changes made to the settings of an existing method are automatically saved with the same method name.
7. Push **EXIT** until the meter returns to the measurement mode.

**Table 2 Custom standard sets**

Standard set values	Option	Description
Std1	1 mg/L	Pre-set temperature compensated standard values.
Std2	10 mg/L	
Std3	100 mg/L	
Std4	1000 mg/L	
Std5	Custom	
	No standard	Standard is undefined when this option is selected.

## Change check standard options

1. Make sure a probe is connected to the meter.
2. Push  and select ISENH3181 Settings.
3. Select Modify Current Settings.
4. Select Check Standards Options and update the settings:

Option	Description
<b>Standard</b>	Sets the check standard—1, 10, 100 or 1000 mg/L. The standard value is shown on the Check Standards Options screen.
<b>Standard Units</b>	When Standard is set to Custom, sets the preferred unit for ISE check standard—mg/L (default), µg/L, g/L, g/kg, mol/L, mmol/L, mol/kg, %, ppm or ppb.
<b>Standard Value</b>	When Standard is set to Custom, enter the standard value using the up/down arrow keys.

5. Select Check Standard Reminder and update the settings:

Option	Description
<b>Reminder</b>	Sets the check standard reminder—On or Off (default). The meter automatically shows the check standard screen if Reminder is On.
<b>Allow Defer</b>	Allows the postponement of check standard reminders—Yes or No. Measurement of the check standard can be delayed if Allow Defer is set to Yes.

6. Select Acceptance Criteria and update the settings:

Option	Description
<b>Acceptance Limits</b>	Sets the tolerance limits for check standard—1% to 20%.
<b>Cal Expires on Failure</b>	Recalibration required if check standard fails—Yes or No. The calibration expires if the check standard fails and Cal Expires is set to Yes.

7. If prompted, enter a name for the new method settings. Additional changes made to the settings of an existing method are automatically saved with the same method name.
8. Push **EXIT** until the meter returns to the measurement mode.

## Maintenance

### Clean the probe

Clean the probe when:

- Drifting/inaccurate readings occur as a result of contamination on the sensing element or improper storage conditions.
- Slow response time occurs as a result of contamination on the sensing element.
- The slope is out of range as a result of contamination on the sensing element.

For general contaminants, complete the following steps.

1. Rinse the probe with deionized water. Blot dry with a lint-free cloth. Do not touch the tip of the probe.
2. If harsh contaminants are attached to the probe, polish the probe tip with a soft cloth or cotton swab to remove the contaminants.
3. Soak for 30 seconds in 25 mL of Ammonia probe storage solution.

## Storage

### Short-term storage

For short-term storage, put the probe with the attached membrane module in 25 mL of Ammonia probe storage solution. Do not let the membrane dry out. A soaker bottle is not required.

### Overnight and mid-term (up to one week) storage

1. Put the Ammonia probe with the attached membrane module in 1000 mg/L Ammonia standard solution without Ionic Strength Adjustor (ISA). Do not let the membrane dry out. A soaker bottle is not required.
2. Put a cover over the storage beaker and probe body to prevent solution evaporation.

### Long-term (more than one week) storage

1. Remove the Ammonia membrane module from the probe body.
2. Rinse the probe and membrane module with deionized water. Blot dry with a lint-free cloth. Do not touch the tip of the probe. Do not rub the membrane surface.
3. Install the protector cap over the membrane module and put the Ammonia membrane module in a protected area. The disassembled membrane module can be allowed to dry.
4. Fill the probe soaker bottle halfway with Ammonia probe storage solution.
5. Install the probe soaker bottle. Make sure the storage solution in the cap completely surrounds the glass bulb.

**Note:** After long-term storage, the ISENH3181 probe (with membrane module assembled) might need to be conditioned in Ammonia probe storage solution for up to 30 minutes to improve the stabilization speed.

## Troubleshooting

Message or symptom	Possible cause	Action
Probe not supported	Software not updated	To download the most current version of the software, refer to the applicable product page on the manufacturer's website. Refer to the HQd Series meter manual for specific instructions for the meter model.
	HQd meter does not support IntelliCAL <sup>®</sup> probe	Contact a Technical Support Representative.
Connect a probe or probe requires service	Probe not connected properly	Disconnect, then connect the probe. Tighten the locking nut.
	Software not updated	To download the most current version of the software, refer to the applicable product page on the manufacturer's website. Refer to the HQd Series meter manual.
	Large number of methods stored on probe.	Continue to let probe connect. Do not disconnect probe.
	Damaged probe	Make sure connectivity with another probe or meter to confirm isolated issue with probe. Contact a Technical Support Representative.
mV reading is the same for all solutions	Soaker bottle not removed	Remove the soaker bottle.
	Electrical issue	Contact a Technical Support Representative.
Slow response time	Dirty sensing element	Clean the probe (body, membrane module and glass bulb). Refer to <a href="#">Clean the probe</a> on page 10.
	Membrane failure	Replace the membrane module.
	Dirty filling solution	Replace the filling solution.
	Low sample temperature or temperature difference between samples	Check the sample temperature. The lower the temperature or the greater the difference of temperatures between samples, traditionally the longer the response time.
	Bubbles trapped under sensor tip	Gently shake the probe until bubbles are removed from under sensor tip.
Slope out of range (refer to <a href="#">Check probe response</a> on page 13)	pH is incorrect	Make sure the pH is > 11 after each ISA addition.
	Ionic strength adjustor (ISA) not used	Add ISA to each sample and standard (one powder pillow per 25 mL of solution).
	Insufficient conditioning	Condition for at least in ammonia probe storage solution.
	Damaged probe	Contact a Technical Support Representative.
	Incorrect standards	Calibrate using freshly prepared standards.
	Dirty sensing element	Clean the probe (body, membrane module and glass bulb) and recalibrate.
	Bubbles trapped under sensor tip	Gently shake the probe until bubbles are removed from under sensor tip.

Message or symptom	Possible cause	Action
Drifting/inaccurate readings	Dirty sensing element	Clean the probe (body, membrane module and glass bulb).
	Clogged reference	Rinse reference junction with deionized water thoroughly and shake the probe downward to remove any air bubbles.
	Samples lose ammonia content	Measure samples and standards within 15 minutes after ISA is added (ammonia gas can escape from the solution). Add Parafilm over the top of the samples and standards to reduce Ammonia loss. Cut a hole for the electrode.
	Improper storage conditions	Clean or condition the probe (refer to <a href="#">Clean the probe</a> on page 10) and attempt another calibration. To re-condition the probe and reference junctions, allow the probe to soak in ammonia probe storage solution for at least 30 minutes prior to use.
	Membrane failure	Replace the membrane module.
	Stabilization criteria not optimized for the application	Adjust the stabilization criteria in the measurement options menu.
	Magnetic stirrers may generate sufficient heat to change solution temperature.	Put a piece of insulating material between the stirrer and beaker.
	Damaged probe	Contact a Technical Support Representative.
	Electromagnetic Forces (EMF) such as voltaic cells, thermoelectric devices, electrical generators, resistors and transformers	Do not use in areas where EMF is present.
	Insufficient amount of filling solution	Add filling solution.
	Colloidal and/or particles in the filling solution.	Replace the filling solution, calibrate and retest.
	Bubbles trapped under sensor tip	Gently shake the probe until bubbles are removed from under sensor tip.
Temperatures of calibration standards and samples are not within $\pm 2$ °C of each other.	Make sure that the temperatures are within $\pm 2$ °C of each other.	
Out of range	Measurement value is outside of range	Make sure that the sample is within the range of the probe.
Out of limits	Check standard value is outside of limits set in the current method	Make sure that the standard is within the limits of the current method.
		Make another method that expands the acceptable limits.
	Measurement value is outside of measurement limits set in the current method.	Make sure that the sample is within the limits of the current method.
Make a new method with an expanded range.		

Message or symptom	Possible cause	Action
Temperature out of range	Calibration temperature value is outside of range	Make sure that the sample temperature is within the range of the probe. Make sure that the temperature sensor is working correctly.
	Measured temperature is outside the range of the probe.	Make sure that the standard temperature is within the range of the probe. Make sure that the temperature sensor is working correctly.
	Check standard temperature value is outside of range	Make sure that the check standard temperature is within the range of the probe.
	Measurement is not quantifiable with current saved calibration (based on IUPAC-defined practical detection limit).	Perform a new calibration. Check that sample concentration is bracketed between two standard solution values (if within linear range). Re-run calibration and measurement, optimizing meter settings for slope acceptance and stabilization criteria for expected sample concentration. Re-run calibration and sample measurement with the tips for low-level measurement.
Below detection limit	Measurement value is outside of range.	Make sure sample is within the range of the probe.

### Check probe response

To make sure there is a probe response, measure the probe potential (in mV) of two Ammonia Standard Solutions one decade apart that are above and below the expected sample concentration. For example, use 10 and 100 mg/L Ammonia Standard Solutions. The two solutions should have potentials (difference in mV readings) that are 57 mV apart at 25 °C (within the slope limits of the method is acceptable). Both solutions should be above 0.5 mg/L Ammonia.

### Check accuracy of sample reading

To make sure the sample measurement is accurate, add a spike of Ammonia Standard Solution with the volumetric pipet. Refer to [Table 3](#) and formulas to calculate the percent of recovery.

Typically a percent of recovery of 100% ±5% is a good indication that the instrument, technique and the sample do not contribute to measurement errors.

**Table 3 Spike reference**

Measured sample concentration	Volume of standard at add	Concentration of standard
1 to 2 mg/L	0.5 mL	100 mg/L
3 to 6 mg/L	1.0 mL	100 mg/L
7 to 15 mg/L	0.3 mL	1000 mg/L
15 to 30 mg/L	0.5 mL	1000 mg/L
30 to 60 mg/L	1.0 mL	1000 mg/L

### Percent recovery

Use the following formula to calculate the percent recovery when the sample volume is 25 mL:

$$E = (C \times V_1) / V_2$$

$$R = (A / (E + S)) \times 100$$

- S = mg/L of Ammonia in sample (before spike)
- C = concentration of standard used for spiking (mg/L)

- $V_1$  = spike volume (mL)
- $V_2$  = spike volume (mL) + 25 mL sample volume
- E = expected concentration of spike (mg/L)
- R = percent recovery
- A = actual reading on meter after spike (mg/L Ammonia)

**HACH COMPANY World Headquarters**

P.O. Box 389, Loveland, CO 80539-0389 U.S.A.  
Tel. (970) 669-3050  
(800) 227-4224 (U.S.A. only)  
Fax (970) 669-2932  
orders@hach.com  
www.hach.com

**HACH LANGE GMBH**

Willstätterstraße 11  
D-40549 Düsseldorf, Germany  
Tel. +49 (0) 2 11 52 88-320  
Fax +49 (0) 2 11 52 88-210  
info@hach-lange.de  
www.hach-lange.de

**HACH LANGE Sàrl**

6, route de Compois  
1222 Vézenaz  
SWITZERLAND  
Tel. +41 22 594 6400  
Fax +41 22 594 6499



# Nitrogen, Ammonia

## Salicylate Method

Method 10205

0.015 to 2.00 mg/L NH<sub>3</sub>-N (ULR)

TNTplus™ 830

**Scope and application:** For municipal and industrial wastewaters, environmental waters and watershed protection monitoring.



### Test preparation

## Instrument-specific information

Table 1 shows all of the instruments that have the program for this test. The table also shows the adapter and light shield requirements for the applicable instruments that can use TNTplus vials.

To use the table, select an instrument, then read across to find the applicable information for this test.

**Table 1 Instrument-specific information for TNTplus vials**

Instrument	Adapters	Light shield
DR 6000, DR 5000	—	—
DR 3900	—	LZV849
DR 3800, DR 2800	—	LZV646
DR 1900	9609900 or 9609800 (A)	—

## Before starting

DR 3900, DR 3800, DR 2800: Install the light shield in Cell Compartment #2 before this test is started.

Review the safety information and the expiration date on the package.

The recommended sample pH is 4–8.

The sample temperature must be 20–23 °C (68–73 °F) for accurate results.

The recommended temperature for reagent storage is 2–8 °C (35–46 °F).

Analyze the samples as soon as possible for best results.

DR 1900: Go to All Programs>LCK or TNTplus Methods>Options to select the TNTplus number for the test. Other instruments automatically select the method from the barcode on the vial.

Review the Safety Data Sheets (MSDS/SDS) for the chemicals that are used. Use the recommended personal protective equipment.

Dispose of reacted solutions according to local, state and federal regulations. Refer to the Safety Data Sheets for disposal information for unused reagents. Refer to the environmental, health and safety staff for your facility and/or local regulatory agencies for further disposal information.

## Items to collect

Description	Quantity
Nitrogen, Ammonia ULR TNTplus Reagent Set	1
Pipet, adjustable volume, 1.0–5.0 mL	1
Pipet tips, for 1.0–5.0 mL pipet	1

Refer to [Consumables and replacement items](#) on page 4 for order information.

## Sample collection and storage

- Collect samples in clean glass or plastic bottles.
- Analyze the samples as soon as possible for best results.
- To preserve samples for later analysis, adjust the sample pH to less than 2 with concentrated hydrochloric acid. No acid addition is necessary if the sample is tested immediately.
- Keep the preserved samples at or below 6 °C (43 °F) for a maximum of 28 days.
- Let the sample temperature increase to room temperature before analysis.
- Before analysis, adjust the pH to 7 with 5 N sodium hydroxide solution.
- Correct the test result for the dilution caused by the volume additions.

## Test procedure

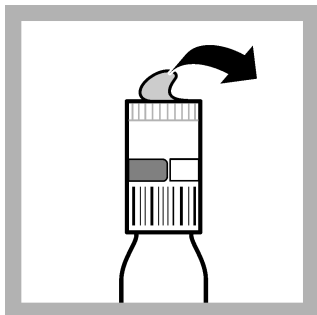

1. Carefully remove the lid from the DosiCap™ Zip cap. Remove the cap from the test vial.

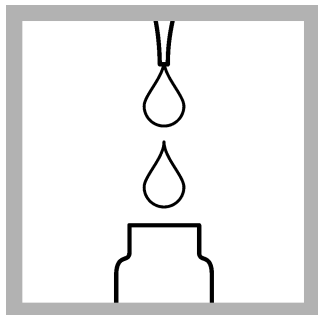

2. Use a pipet to add 5.0 mL mL of sample to the test vial. Immediately continue to the next step.

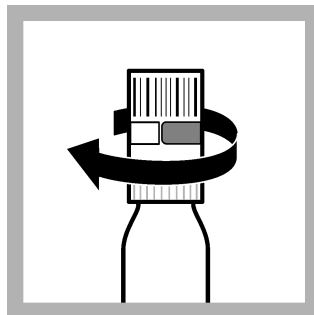

3. Turn the DosiCap Zip over so that the reagent side goes on the test vial. Tighten the cap on the vial.

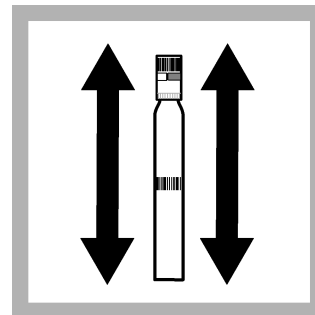

4. Shake the vial 2–3 times to dissolve the reagent in the cap. Look through the open end of the DosiCap to make sure that the reagent has dissolved.

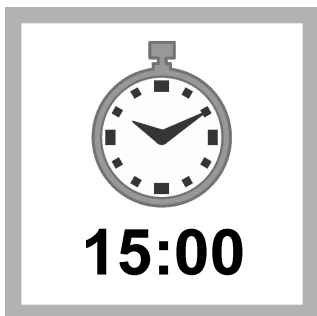

5. Start the reaction time of 15 minutes.

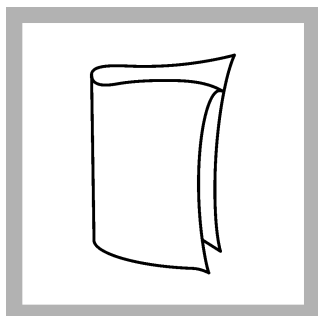

6. Clean the vial.

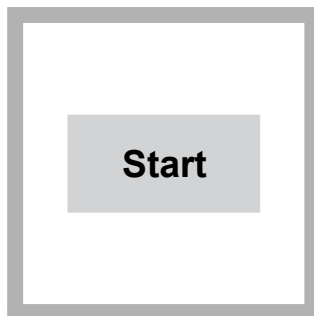

7. DR 1900 only: Select program 830. Refer to [Before starting](#) on page 1.

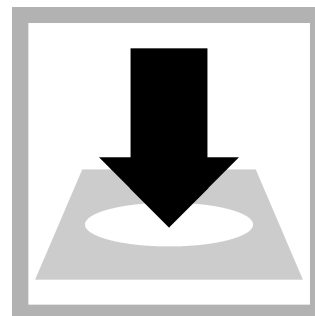

8. Insert the vial into the cell holder. DR 1900 only: Push **READ**. Results show in mg/L NH<sub>3</sub>-N.

## Reagent blank correction

For the best results, measure the reagent blank value for each new lot of reagent. Replace the sample with deionized water in the test procedure to determine the reagent blank value. Subtract the reagent blank value from the sample results automatically with the reagent blank adjust option. Measure the reagent blank value when a new lot of reagent is used.

1. Use deionized water as the sample in the test procedure to measure the reagent blank value.
2. Set the reagent blank function to on. The measured reagent blank value is shown.



3. Accept the blank value. The reagent blank value is then subtracted from all results until the reagent blank function is set to off or a different method is selected.

**Note:** As an alternative, record or enter the reagent blank value at a different time. Push the highlighted reagent blank box and use the keypad to enter the value.

## Sample blanks

Samples with color or turbidity can cause high results. Samples without color or turbidity do not require sample blanks. To adjust for color or turbidity, use the steps that follow to find the sample blank.

1. Do the test procedure, but do not remove the foil lid from the vial.
2. Put the cap on the vial.
3. Subtract the value from the final procedure step from the initial sample value to get the corrected sample concentration.

## Interferences

Table 2 shows that the ions were individually examined to the given concentrations and do not cause interference. No cumulative effects or influences of other ions were found.

Primary amines are found and cause high-bias results. A 10,000-fold excess of urea does not interfere. All reducing agents interfere and cause low-bias results.

**Note:** An analyte concentration that is larger than the stated range adversely has an effect on color formation, which results in a false reading within the method range.

Verify measurement results with sample dilutions or standard additions.

Distillation is necessary for samples with severe interferences. Complete the distillation procedure with the Hach General Purpose Distillation Set.

**Table 2 Interfering substances**

Interfering substance	Interference level
Cl <sup>-</sup> , SO <sub>4</sub> <sup>2-</sup>	1000 mg/L
K <sup>+</sup> , Na <sup>+</sup> , Ca <sup>2+</sup>	500 mg/L
CO <sub>3</sub> <sup>2-</sup> , NO <sub>3</sub> <sup>-</sup> , Fe <sup>3+</sup> , Cr <sup>3+</sup> , Cr <sup>6+</sup> , Zn <sup>2+</sup> , Cu <sup>2+</sup> , Co <sup>2+</sup> , Ni <sup>2+</sup> , Hg <sup>2+</sup>	50 mg/L
Fe <sup>2+</sup>	25 mg/L
Sn <sup>2+</sup>	10 mg/L
Pb <sup>2+</sup>	5 mg/L
Ag <sup>+</sup>	2 mg/L

## Accuracy check

### Standard solution method

Use the standard solution method to validate the test procedure, the reagents and the instrument.

Items to collect:

- Nitrogen, Ammonia Standard Solution, 1.0-mg/L NH<sub>3</sub>-N or Wastewater Effluent Standard Solution, Mixed Parameter

1. Use the test procedure to measure the concentration of the standard solution.
2. Compare the expected result to the actual result.

**Note:** The factory calibration can be adjusted slightly with the standard adjust option so that the instrument shows the expected value of the standard solution. The adjusted calibration is then used for all test results. This adjustment can increase the test accuracy when there are small variations in the reagents or instruments.

## Summary of Method

Ammonium ions react at pH 12.6 with hypochlorite ions and salicylate ions in the presence of sodium nitroprusside as a catalyst to form indophenol. The amount of color formed is directly proportional to the ammonia nitrogen that is in the sample. The measurement wavelength is 694 nm.

## Pollution prevention and waste management

The ammonia salicylate reagent contains sodium nitroferricyanide which, when digested, is converted to total cyanide and can have an effect on total cyanide limits in the effluent. Dispose of reacted solutions according to local, state and federal regulations.

## Consumables and replacement items

### Required reagents

Description	Quantity/Test	Unit	Item no.
Nitrogen, Ammonia ULR TNTplus Reagent Set	1	25/pkg	TNT830

### Object Missing

This object is not available in the repository.

### Recommended standards

Description	Unit	Item no.
Nitrogen, Ammonia Standard Solution, 1-mg/L NH <sub>3</sub> -N	500 mL	189149
Wastewater Effluent Standard Solution, Mixed Parameter, for NH <sub>3</sub> -N, NO <sub>3</sub> -N, PO <sub>4</sub> <sup>3-</sup> , COD, SO <sub>4</sub> <sup>2-</sup> , TOC	500 mL	2833249

### Optional reagents and apparatus

Description	Unit	Item no.
Distillation apparatus set, general purpose	each	2265300
Distillation heater and support for apparatus set, 115 VAC option	each	2274400
Distillation heater and support for apparatus set, 230 VAC option	each	2274402
Hydrochloric Acid, concentrated	500 mL	13449
Sampling bottle with cap, low density polyethylene, 500-mL	12/pkg	2087079
Sodium Hydroxide Standard Solution, 5.0 N	100 mL MDB	245032
Test tube rack, polyethylene, for 13-mm OD vials, 90 holes	each	2497900
Water, deionized	4 L	27256



FOR TECHNICAL ASSISTANCE, PRICE INFORMATION AND ORDERING:  
 In the U.S.A. – Call toll-free 800-227-4224  
 Outside the U.S.A. – Contact the HACH office or distributor serving you.  
 On the Worldwide Web – [www.hach.com](http://www.hach.com); E-mail – [techhelp@hach.com](mailto:techhelp@hach.com)

HACH COMPANY  
 WORLD HEADQUARTERS  
 Telephone: (970) 669-3050  
 FAX: (970) 669-2932

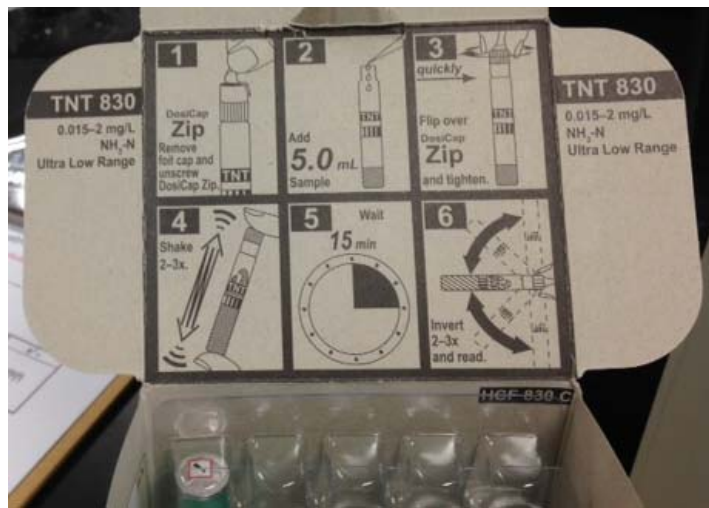

	Sample	True value	Actual reading	Teams				% Recovery for LFB (std)	LFM (Spike) Recovery $\pm 20\%$	RPD $\leq 20\%$		ICV/CCV % Recovery $\pm 10\%$	
				1	2	3	4			A	B		A
1	<b>Blank</b> ( $<$ detection limit)												
2	<b>ICV</b> - 1.0 mg/L NH <sub>3</sub> -N	1.0	0.98										
3	<b>LFB</b> - 0.5 mg/L NH <sub>3</sub> -N	0.5	0.51										
4	Influent, Composite – 25 x dilution		0.96 x 25 = 24.00										
4	<b>LFM</b> Influent, Composite – 25 x dilution *1.0 mg/L NH <sub>3</sub> -N		1.95										
4	<b>LFMD</b> - Influent, Composite – 25 x dilution *1.0 mg/L NH <sub>3</sub> -N		1.98										
5	Sample A - Teams 1 & 2												
6	Sample B – Teams 3 & 4												
7	<b>LFM</b> - Sample Spike *1.0 mg/L NH <sub>3</sub> -N added to Samples A & B			A		B			A	B	A	B	
				1	2	3	4		1	2	3	4	
8	<b>LFMD</b> - Sample Spike Dup * 1.0 mg/L NH <sub>3</sub> -N added to Samples A & B			A		B			A	B	A	B	
				1	2	3	4		1	2	3	4	
10	<b>CCV</b> - 1.0 mg/L NH <sub>3</sub> -N	1.0											

\* For spike – Put 1.0 mL of 100 mg/L standard into 99 mL of sample (A or B). Use 100 mL volumetric flask. That will give you 100 mL of sample and spike. Then, take 5 mL of this to run test. This should raise the sample + spike value by 1.0 mg/L (ppm). Spike volume should be <1% of total volume.

$$\frac{(\text{unspiked sample conc.} * \text{unspiked sample vol.}) + (\text{std conc for spike} * \text{vol of spike})}{(\text{total sample vol.} + \text{spike vol})} = \frac{(? \text{ sample conc} * 100 \text{ mL}) + (100 \text{ mg/L} * 1.0 \text{ mL})}{100 \text{ mL}} = \text{mg/L}$$

### Calculations

- % Recovery for LFB
  - =  $\frac{\text{LFB Result}}{\text{Expected Concentration}} \times 100\%$
- RPD – relative percent differences for duplicates and LFM/LFMD
  - =  $\frac{\text{Difference between sample and duplicate}}{\text{Average of the sample and duplicate}} \times 100\%$
- % Recovery for LFM – when using less than or equal to 1% spike volume compared to sample volume
  - =  $\frac{\text{LFM Result} - \text{Sample Result}}{\text{Actual Concentration of spike}} \times 100\%$

### Calculations

#### Example:

Blanks < MDL (example 0.004 mg/L)

$$\text{LFB} \pm 10\% \quad \frac{0.51 - 0.50}{0.5} * 100\% = 2.0\%$$

ICV/CCV  $\pm 10\%$

LFM/LFMD  $\pm 10\%$  Recovery

$$1.22 - 0.051 = 1.17/1 \text{ mg/L} = 1.17 * 100 = 117\%$$

$$1.13 - 0.051 = 1.08/1 \text{ mg/L} = 1.08 * 100 = 108\%$$

Reporting Limit = MDL

$$\text{RPD} < 20\% \text{ (for LFM/LFMD)} = \frac{1.22 - 1.13}{\frac{(1.22 + 1.13)}{2}} = \frac{0.09}{1.175} = 0.0766 * 100 = 7.66\%$$

## APPLICATION NOTE

# SELECTING THE RIGHT AMMONIA METHOD FOR YOUR LAB

## Choosing Between Colorimetric and Ion-Selective Electrode Methodologies

Ion-Selective Electrodes (ISE) have been the standard for ammonia measurement in many water and wastewater laboratories. The ISE ammonia method is USEPA approved and has a wide dynamic range making it attractive to many labs. However, ISE technology has some significant disadvantages including maintenance, calibration, poor low-level performance, and replacement of the sensor system. In 2008, Hach Company gained USEPA Equivalence on a simple colorimetric ammonia method for use in wastewater based on the TNTplus™ platform. Now, many facilities find themselves asking some basic questions:

- Has the TNTplus technology been proven in my type of facility?
- Which method is best for my facility?
- How do I switch methods and will my regulator allow it?
- Does it make financial sense to switch?



Tamara (Tami) Moon-Carlson is the Lead Laboratory Analyst at the Northglenn, Colorado WTP. Ms. Moon-Carlson manages the drinking water and wastewater laboratories for a WW plant and a DW plant. Northglenn has used ISE technology for ammonia measurement for many years. After learning about the new Ammonia TNTplus method in 2010, Tami was asking those same questions. She followed a three-step process:

- 1) Understand the advantages and disadvantages of each method, including the costs and analyst training requirements
- 2) Talk with the local regulator to understand the steps needed to change methods. The regulator outlined a simple side-by-side analysis required to switch
- 3) Acquire the technology and develop Standard Operating Procedures based on the Hach Method

## Overview of Two Technologies

### Colorimetric – EPA Equivalent TNTplus Ammonia – Salicylate Method

Ammonium ions react at pH 12.6 with hypochlorite ions and salicylate ions in the presence of sodium nitroprusside as a catalyst to form indophenol. The amount of color formed is directly proportional to the ammonia in the sample. Results are read at 690 nm. The TNTplus barcode communicates with the TNTplus-compatible spectrophotometer and displays the concentration of ammonia in the sample.

### Electrochemical – EPA Approved Ammonia Ion-Selective (ISE) Electrode

The ammonia electrode measures ammonia gas or ammonium ions in aqueous solutions. The electrode consists of a glass pH electrode, reference electrode, and gas-permeable membrane. The gas-permeable



membrane separates the sample from a thin layer of electrolyte that is pressed between the pH bulb and the membrane. At high pH, ammonium ion is converted to ammonia gas. The gas diffuses through the membrane and causes a pH change in the thin layer of electrolyte. The change in pH is proportional to the ammonia concentration in the sample.

### Comparison of ISE and Colorimetric TNTplus Methods

Technology	Advantages	Disadvantages
ISE	<ul style="list-style-type: none"> <li>• Wide dynamic range</li> <li>• Cost effective for greater than approximately 15 tests/day</li> <li>• Few interferences</li> <li>• Common measurement system for ammonia in laboratories</li> </ul>	<ul style="list-style-type: none"> <li>• Time and labor intensive calibration procedure and standard preparation</li> <li>• Slow response at low level ammonia concentrations (&lt;0.5-1 mg/L NH<sub>3</sub>-N)</li> <li>• Maintenance of electrode and membrane</li> <li>• Sensor drift during measurement</li> </ul>
Colorimetric TNTplus	<ul style="list-style-type: none"> <li>• Simple 15-minute test procedure (no calibration curve generation required)</li> <li>• Bar-coded TNTplus assure right method and range are selected</li> <li>• Cost effective for less than approximately 15 tests/day</li> <li>• Good low-level performance and linear throughout the measurement range</li> </ul>	<ul style="list-style-type: none"> <li>• Hazardous waste disposal (cyanide-containing waste)</li> <li>• Range-specific reagent sets</li> <li>• Possible interferences (but not typical in most wastewater matrices)</li> </ul>

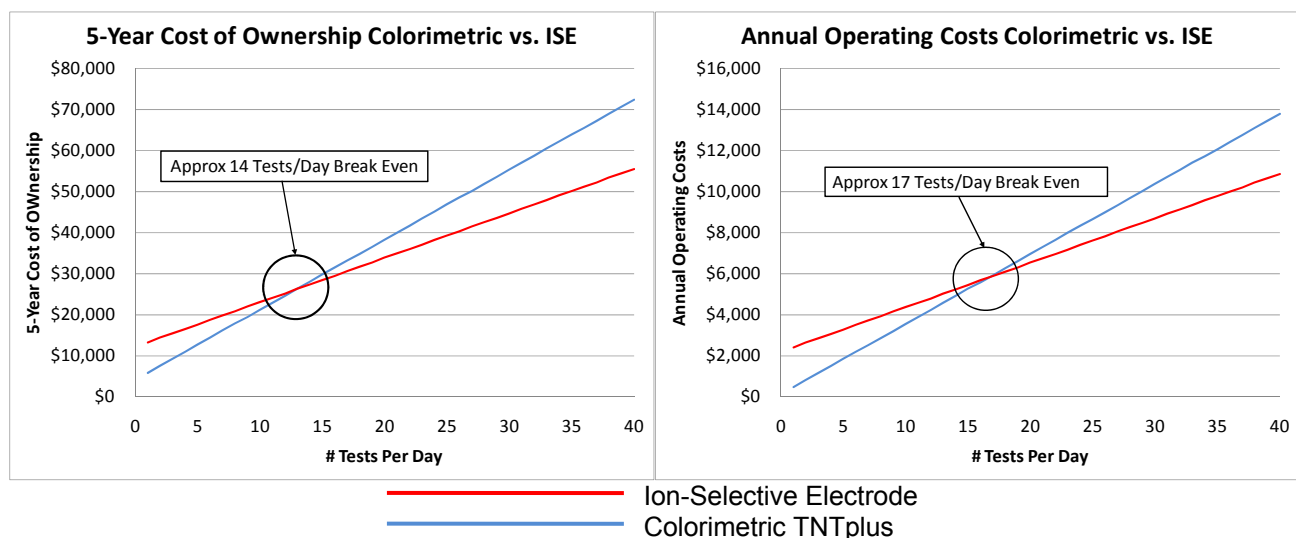

*Example Assumptions: Fully-burdened labor: \$20/hour; Setup/calibration/standard preparation for ISE: 30 minutes; New ISE probe each year: \$1000; New ISE Meter: \$1200; New Spectrophotometer: \$3500; Direct labor for each test: 5 minutes; Example Uses 100 Testing Days/Year (Relative Costs Increase/Decrease Linearly)*

### Summary:

After considering the advantages and disadvantages of both measurement systems, the Northglenn team selected the TNTplus system. They completed a simple side-by-side study (approximately 4 hours of lab work) and submitted the results to their local regulator. Today, Northglenn makes many measurements per day for regulatory reporting and process control tests. Multiple operators over multiple shifts have had comparable results and required minimal training.

## Technical Summary: Demonstration of Performance in Municipal and Industrial Wastewater Samples

### Equipment for Colorimetric Tests

- Hach DR5000 Spectrophotometer
- Ultra-Low Range Ammonia TNTplus 0.015-2.000 mg/L NH<sub>3</sub>-N (TNT830)
- Low Range Ammonia TNTplus 1-12 mg/L NH<sub>3</sub>-N (TNT831)
- High Range Ammonia TNTplus 2-47 mg/L NH<sub>3</sub>-N (TNT832)

### Equipment for Ion-Selective Electrode Tests

- Hach sensION4 Electrochemistry Meter
- sensION Ammonia ISE
- Calibration standards were made fresh and the ISE was calibrated 3 times per day at 0.1, 1.0, and 10 mg/L NH<sub>3</sub>-N to assure accuracy (Slope 1: 58.8mV; Slope 2: 56.8mV; Slope 3: 57.2mV – All slopes were within the 58 +/-3mV performance criteria)

Five different Municipal Wastewater and five different Industrial Wastewater samples were analyzed side-by-side using each technology. A 5 mg/L NH<sub>3</sub>-N spike was added to each matrix to calculate percent recovery.

	ISE Test 1	ISE Test 2	ISE Spike 1	ISE Spike 2	ISE % Rec. Average	TNTplus Test 1	TNTplus Test 2	TNTplus Spike 1	TNTplus Spike 2	TNTplus % Rec. Average
Muni1	0.237	0.243	5.36	5.22	101.0%	0.187	0.189	5.31	5.31	102.4%
Muni2	0.166	0.173	5.3	5.25	102.1%	0.09	0.092	5.16	5.03	100.1%
Muni3	0.362	0.343	5.58	5.48	103.6%	0.255	0.257	5.32	5.27	100.8%
Muni4	5.94	6.01	9.04	9.32	64.1%	3.74	3.61	8.68	8.51	98.4%
Muni5	0.0733	0.0753	4.84	4.92	96.1%	0.023	0.023	5.03	4.97	99.5%
Ind1	4.82	4.88	8.8	8.93	80.3%	3.95	3.9	8.45	8.4	90.0%
Ind2	7.63	7.63	10.3	10.3	53.4%	5.9	5.9	10.3	10.3	88.0%
Ind3	0.546	0.546	5.15	5.15	92.1%	0.401	0.401	5.4	5.4	100.0%
Ind4	1.175	1.09	5.77	5.72	92.3%	0.945	0.921	5.61	5.7	94.4%
Ind5	0.253	0.236	5.3	5.28	100.9%	0.168	0.166	5.2	5.12	99.9%

Outside of calibration range  
Outside of acceptance criteria

All results in mg/L NH<sub>3</sub>-N



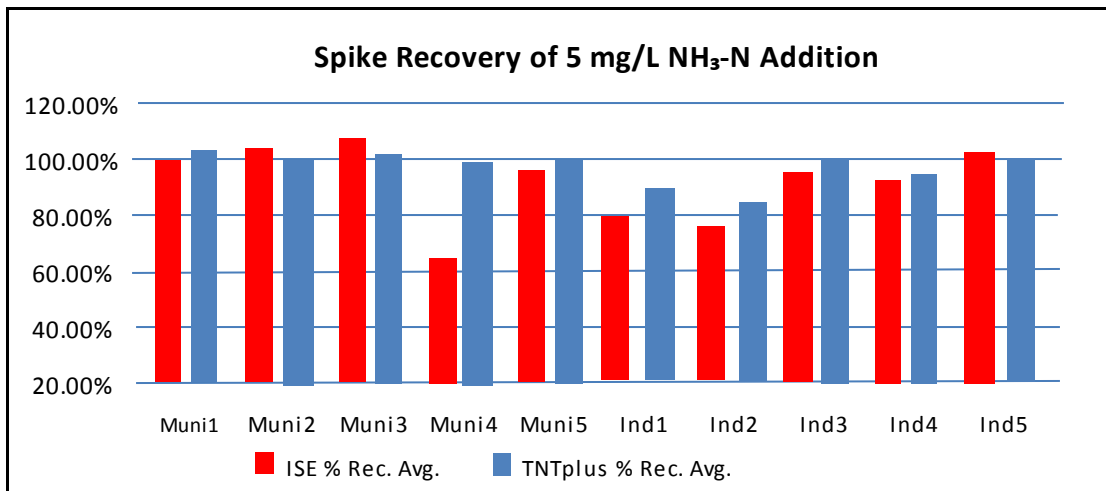

**FOR TECHNICAL ASSISTANCE, PRICE INFORMATION AND ORDERING:**  
 Tel: 800-227-4224 | E-Mail: [techhelp@hach.com](mailto:techhelp@hach.com)  
 To locate the HACH office or distributor serving you, visit: [www.hach.com](http://www.hach.com)

LIT2194

© Hach Company, 2014. All rights reserved.

*In the interest of improving and updating its equipment, Hach Company reserves the right to alter specifications to equipment at any time.*



# Section 5 Nutrients

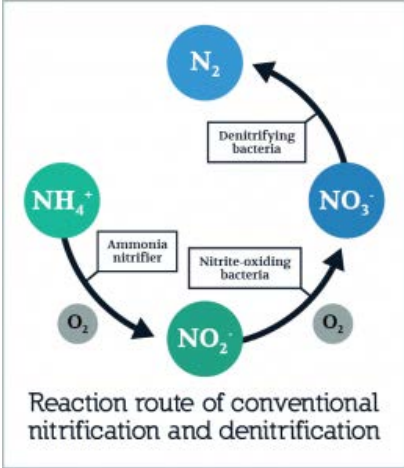

## Nutrients

Ammonia  
Nitrite, Nitrate  
Total Kjeldahl Nitrogen (TKN),  
Phosphorus



TDEC - Fleming Training Center 1

## Sample Points

Virtual Wastewater  
<http://virtualwastewater.hach.com/>

TDEC - Fleming Training Center 2

## Nutrients

- A balanced nutrient ration is essential for microorganism health
  - Function at maximum efficiency
- Most important nutrients are
  1. Carbon
  2. Nitrogen
  3. Phosphorus

TDEC - Fleming Training Center 3

## Carbon

- Principal component of the organic substances found in wastewater
- Biodegraded by microorganisms in activated sludge
  - Anaerobic conditions
  - Anoxic conditions (denitrification)
  - Aeration basin (nitrification)
- Use carbon to build cell structures and generate energy

TDEC - Fleming Training Center 4

## Nitrogen Group - N

- In water and wastewater the forms of nitrogen that are of greatest interest are:
  - Nitrate
  - Nitrite
  - Ammonia
  - Organic Nitrogen

TKN { } Inorganic Nitrogen } Total Nitrogen

TDEC - Fleming Training Center 5

## Nitrogen

- The influent wastewater contains:
  - Organic N
  - Ammonium N (NH<sub>4</sub><sup>+</sup>)
- Organic N converted to NH<sub>4</sub><sup>+</sup> by bacteria in activated sludge
  - NH<sub>4</sub><sup>+</sup> ⇒ Nitrite ⇒ Nitrate
- The Nitrogen compounds not degraded are converted in anoxic zone
  - Nitrate ⇒ Nitrogen gas

TDEC - Fleming Training Center 6

## Phosphorus Group - P

- Elemental phosphorus never occurs by itself in water, always as some kind of compound
  - Dissolved or particulate
- Phosphorus occurs in natural water and wastewater almost solely as phosphates
  - Inorganic form (ortho and poly)
  - Organic (organically bound)

TDEC - Fleming Training Center

7

## Phosphorus Group - P

- 3 Main types of phosphorus in water
  1. Orthophosphate
  2. Condensed phosphate
    - (Ex: Polyphosphates)
  3. Organic phosphate
    - Organically bound
- All of these together form Total P

TDEC - Fleming Training Center

8

## Phosphorus

- During biological WW treatment, polyphosphates and organically bound phosphorus are converted to orthophosphate
- Microorganisms need P for energy metabolism – to form the cell membrane and DNA

TDEC - Fleming Training Center

9

## Orthophosphate

- Known as “reactive phosphorus”
- Small amounts (with polyphosphates) are added to some water supplies during treatment
- Most stable form
- Form used by plants
- Produced by natural processes and is found in sewage

TDEC - Fleming Training Center

10

## Condensed Phosphates

- Poly-, Meta-, Pyro-
- Used for treating boiler waters
- Found in detergents
- Unstable in water and will convert into orthophosphates

TDEC - Fleming Training Center

11

## Organic Phosphate

- Phosphate bound to plant or animal tissue
- Formed primarily by biological processes
- Contributed to sewage by body wastes and food residues
- May be formed from orthophosphates in biological treatment processes or by receiving water biota
- Can result from a breakdown of organic pesticides that contain phosphate

TDEC - Fleming Training Center

12

## Phosphorus

- Types of Phosphorus Analyses include:
  - Orthophosphate
  - Acid Hydrolyzable Phosphate/Condensed Phosphate
  - Total Phosphorous/Organic Phosphate
- Only Orthophosphate can be measured directly
  - Other forms must be converted to this

TDEC - Fleming Training Center 13

## Containers, Preservation & Holding Times

Parameter	Container	Preservation	Max. Holding
Nitrate	P, G	Cool, ≤ 6° C	48 hours
Nitrite	P, G	Cool, ≤ 6° C	48 hours
Ortho-phosphate	P, G	Cool, ≤ 6° C	48 hours
Nitrate + Nitrite	P, G	Cool, ≤ 6° C, H <sub>2</sub> SO <sub>4</sub> to pH <2	28 days
Ammonia	P, G	Cool, ≤ 6° C, H <sub>2</sub> SO <sub>4</sub> to pH <2	28 days
Kjeldahl Nitrogen,	P, G	Cool, ≤ 6° C, H <sub>2</sub> SO <sub>4</sub> to pH <2	28 days
Phosphorus, Total	P, G	Cool, ≤ 6° C, H <sub>2</sub> SO <sub>4</sub> to pH <2	28 days

TDEC - Fleming Training Center 14

## NO<sub>3</sub>+NO<sub>2</sub> Methods for NPDES

Parameter	Methodology	Standard Methods
NO <sub>3</sub> +NO <sub>2</sub> -N	Ion Chromatography	4110 B – 2011 or C – 2011
	Automated Hydrazine	4500-NO <sub>3</sub> H – 2011
	Cd-reduction, automated	4500-NO <sub>3</sub> F – 2011
	Cd-reduction, manual	4500-NO <sub>3</sub> E – 2011
	Spectrophotometric	Hach 10206

TDEC - Fleming Training Center 15

## Nitrite Methods for NPDES

Parameter	Methodology	Standard Methods
Nitrite (as N)	Ion Chromatography	4110 B – 2011 or C – 2011
	Spectrophotometric (Manual)	4500-NO <sub>2</sub> B – 2011
	Automated, by pass Cd-reduction column	4500-NO <sub>3</sub> F – 2011
	Spectrophotometric	Hach* Method 8507 *Footnote 25, 40 CFR 136 Table IB

TDEC - Fleming Training Center 16

## Nitrate Methods for NPDES

Parameter	Methodology	Standard Methods
Nitrate (as N)	Ion Chromatography	4110 B – 2011 or C – 2011
	Ion Selective Electrode	4500- NO3 D - 2011
	Spectrophotometric	Hach 10209 (TNT 836) 2011
	Colorimetric	No longer approved
	Nitrate + Nitrite N Minus Nitrite N	Subtract value of Nitrite from value of Nitrate-Nitrite
	Spectrophotometric	Hach 10206

17

## Ammonia Methods for NPDES

Parameter	Methodology	Standard Methods
Ammonia, (as N)	Distillation or gas diffusion (pH>11) followed by:	4500-NH <sub>3</sub> B – 2011
	•Nesslerization	No longer an approved method in Standard Methods
	•Titration	4500-NH <sub>3</sub> C – 2011
	•Electrode	4500-NH <sub>3</sub> D – 2011 or E – 2011
	•Automated phenate	4500-NH <sub>3</sub> G – 2011 or H – 2011

TDEC - Fleming Training Center 18

### TKN Methods for NPDES

Parameter	Methodology	Standard Methods
TKN (as N)	Digestion and Distillation followed by:	4500-N <sub>org</sub> B – 2011 or C -2011
	•Titration	4500-NH <sub>3</sub> C - 2011
	•Nesslerization	No longer approved
	•Electrode	4500-NH <sub>3</sub> D – 2011 or E – 2011
	•Digestion with peroxodisulfate, followed by Spectrophotometric	Hach 10242

TDEC - Fleming Training Center 19

### Total Phos. Methods for NPDES

Parameter	Methodology	Standard Methods
Phosphorus-Total	Persulfate digestion followed by:	4500-P B(5) – 2011
	•Manual	4500-P E – 2011
	•Automated ascorbic acid reduction	4500-P F – 2011, G – 2011 or H – 2011
Hach Total and Reactive Phosphorus Method 10209/10210 TNTplus 843		

TDEC - Fleming Training Center 20

### Ortho-Phos Methods for NPDES

Parameter	Methodology	Standard Methods
Ortho-Phosphate (P)	Ascorbic Acid Method	4500-P E - 2011
	•Automated	4500-P F – 2011 or G – 2011
	•Manual single reagent	4500-P E – 2011

TDEC - Fleming Training Center 21

### Common Findings in Testing

Common Ranges	Influent	Effluent
<b>Total Phosphorous</b>	4 – 12 mg/L	2 – 10 mg/L
<b>Orthophosphate</b>	2 – 8 mg/L	1 – 6 mg/L

TDEC - Fleming Training Center 22

### Environmental Impact

- Phosphate will stimulate the growth of aquatic plants
- High levels of phosphates entering waterways can stimulate algae, aquatic plants to grow wildly which chokes up the waterways and uses up large amounts of dissolved oxygen



Algal growth fueled by nutrients running off agricultural fields and from urban areas) spreading into the Gulf of Mexico off the coast of Florida.

TDEC - Fleming Training Center 23

### Environmental Impact

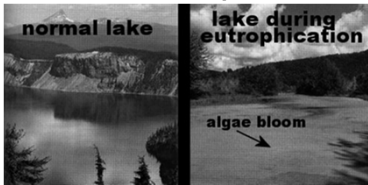

- Eutrophication or over-fertilization of receiving water from wastewater effluents
- Digestive problems can occur from extremely high levels of phosphate

TDEC - Fleming Training Center 24

## Eutrophication

- Eutrophication is an increase in chemical nutrients (compounds containing nitrogen or phosphorus) in an ecosystem, and may occur on land or in water.
- Term is often used to mean the resultant increase in the ecosystem's primary productivity (excessive plant growth and decay)
- Once algae blooms, it will die off and as the algae decay bacteria will consume it and use up all the oxygen.

TDEC - Fleming Training Center 25

## Eutrophication

- Effects include:
  - Excessive plant growth
  - Unsightly scum of algae on water surface
  - Lack of oxygen
  - Severe reductions in water quality
  - Reduction in fish populations and other animal populations
  - Negatively impact recreational use
    - Boating, fishing, swimming

TDEC - Fleming Training Center 26

## Eutrophication

- Gulf of Mexico
  - Currently the most notorious dead zone is a 8,543 mi<sup>2</sup> region in the Gulf of Mexico, where the Mississippi River dumps high-nutrient runoff from its vast drainage basin, which includes the heart of U.S. agribusiness, the Midwest.
  - The drainage of these nutrients are affecting important shrimp fishing grounds.
  - This is equivalent to a dead zone the size of New Jersey.

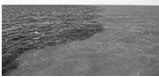

TDEC - Fleming Training Center 27

## Eutrophication

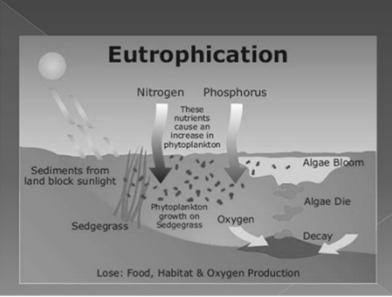

TDEC - Fleming Training Center 28

## Sources of Eutrophication

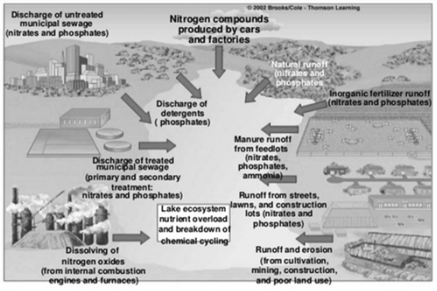

TDEC - Fleming Training Center 29

## Eutrophication Video

### Mississippi River Basin



TDEC - Fleming Training Center 30

## Reversal of Dead Zones

- Dead zones are reversible.
- The Black Sea dead zone, previously the largest dead zone in the world, largely disappeared between 1991 and 2001 after fertilizers became too costly to use following the collapse of the Soviet Union and the demise of centrally planned economies in Eastern and Central Europe.
- Fishing has again become a major economic activity in the region

TDEC - Fleming Training Center 31

## Environmental Impact - Nitrate

- Excess nitrate in drinking water can harm young infants or young livestock
  - Restriction of oxygen transport in bloodstream
  - Infants under 4 months – “Blue baby syndrome”
- Risk of contamination of shallow groundwater wells

TDEC - Fleming Training Center 32

## Acid Persulfate Digestion Method EPA Approved

- Gather sample
- Measure 50 ml into Erlenmeyer flask
- Add .5 grams of Potassium Persulfate and mix
- Add 2.0 ml of 5.25 Normality Sulfuric Acid Solution
- Place flask on hot plate and Boil gently for 30 minutes
- Cool sample to room temperature
- Add 2.0 ml of 5.0 Normality Sodium Hydroxide and mix
- Pour sample into 25 ml graduated cylinder and into clean sample bottle
- Proceed with reactive phosphorus test
- The digestive method is performed prior to testing for total phosphorus

TDEC - Fleming Training Center 33

## Phosphorus PhosVer (Ascorbic Acid) Reactive Method

- Gather sample
- Fill a sample cell with one PhosVer 3 Phosphate powder pillow or use AccuVac Ampuls
- Swirl to mix reagent
- Two minute reaction time before testing
- Fill another sample cell with water from sample: This is your blank. Place in the cell holder of the analytical machine
- When timer beeps, the display will show mg/L P PV\_press zero and wait for display to show 0.00 mg/L PO<sub>4</sub><sup>3-</sup>
- Place the sample into the machine and press read/enter (DR 4000 will do this automatically)
- If phosphate is present, the sample will turn BLUE in color.

TDEC - Fleming Training Center 34

## Phosphorus SM4500-P B and E -2011

- DOC
- MDL
- LRB
- LFB
- LFM/LFMD
- ICAL/CCV
- Control Charts
- Corrective Action
- QC Acceptance
- Batch Size
- QC Frequency



TDEC - Fleming Training Center 35

## Phosphorus SM4500-P B and E -2011

- Demonstration of Capability (DOC)
  - Run a laboratory-fortified blank (LFB) at least four times and compare to the limits listed in the method
  - Real people language: each operator running this test need to analyze 4 samples of a Phosphorus Standard at a concentration around 0.5 mg/L.
  - Documentation (signed form) that analyst has read and understands all appropriate SOPs and Methods.
  - Recommend backup analyst do this once a year.

TDEC - Fleming Training Center 36

### Phosphorus SM4500-P B and E -2011

- MDL- Estimated Detection Level=0.01 mg/L
  - From SM 1030 C.
    - $0.01 \text{ mg/L} * 5 = 0.05 \text{ mg/L} \sim \text{MDL}$
    - **Make a 0.05 mg/L standard**
    - **Analyze 7 portions over 3 days**
    - Calculate standard deviation (S)
      - $n1 \Sigma + n2 \Sigma + n3 \Sigma + \dots + n7 \Sigma + 2^{nd} \alpha xn = S$
    - $S * 3.14 = \text{MDL}$

TDEC - Fleming Training Center 37

### Phosphorus SM4500-P B and E -2011

- Determine Initial MDL
  - Process minimum of 7 spiked samples and 7 method blanks through all steps of the method
  - Samples prepared in at least 3 batches on 3 separate calendar dates and analyzed on 3 separate calendar dates
  - Calculate standard deviation (S)
  - Calculate  $\text{MDL}_s$  and  $\text{MDL}_b$
  - Select the greater of  $\text{MDL}_s$  or  $\text{MDL}_b$  as the initial MDL

TDEC - Fleming Training Center 38

### Phosphorus SM4500-P B and E -2011

- MDL: Ongoing Data Collection
  - 2  $\text{MDL}_s$ /quarter
  - Use routine method blanks
  - Ensure at least 7  $\text{MDL}_s$  samples and 7 method blanks are completed for annual verification
  - At least once per year, re-evaluate the spiking level

TDEC - Fleming Training Center 39

### Phosphorus SM4500-P B and E -2011

- MDL: Ongoing Annual Verification
  - At least once every 13 months, re-calculate the  $\text{MDL}_s$  and  $\text{MDL}_b$
  - Include data generated within the last 24 months, but only data with same spiking level
  - Include initial MDL spiked samples if the data were generated within 24 months
  - Ideally, use all method blank results from the last 24 months
  - The verified MDL is the greater of the  $\text{MDL}_s$  or  $\text{MDL}_b$

TDEC - Fleming Training Center 40

### Phosphorus SM4500-P B and E -2011

- Method Blank – goes through digestion
  - Real people language: analyze distilled water as a sample by going through digestion and reagent addition before reading
    - Target value is less than reporting limit
    - Reporting limit will be equal to your Method Detection Limit (MDL)
    - Run on a 5% basis, one for every 20 samples
- Laboratory Fortified Blank – goes through digestion
  - Real people language: analyze a phosphorus standard at a concentration around 0.5 mg/L
    - Run on a 5% basis, one for every 20 samples

TDEC - Fleming Training Center 41

### Phosphorus SM4500-P B and E -2011

- Lab fortified matrix & duplicate (spike& spike dup)
  - 4020 B.2.g. – When appropriate for the analyte, include at least one LFM/LFMD daily or with each batch of 20 or fewer samples
    - Add a known concentration of analyte (ideally from a second source) to a randomly selected routine sample without increasing its volume by more than 5%
    - Calculate percent recovery and relative percent difference, plot control charts and determine control limits for spikes at different concentrations
- Real people language – add a known amount of phosphorus to a sample and expect that amount to increase your sample concentration
  - Run on a 5% basis (1 for every 20 samples or once per month, whichever is more frequent)
  - Calculate RPD between spiked sample and spiked duplicate, target value should be close to the first value and have a small RPD (less than 20%).
  - Spike volume should be less than 1% of the volume.
    - Example: spike with 0.1 mL of 100 mg/L into 10 mL sample will equal a 1 mg/L increase in phosphorus concentration.

42



### Phosphorus SM4500-P B and E -2011

- Initial Calibration – does not go through digestion
  - Analyze 2-3 different standards within the curve
    - Run on a 5% basis, one for every 20 samples
- Calibration Verification – does not go through digestion
  - Analyze a mid-range phosphorous standard daily (day of)
    - Hach's method range is 0.2-2.50 mg/L, a 1 mg/L would work at your daily check standard

TDEC - Fleming Training Center 43

### Phosphorus SM4500-P B and E -2011

- **2014 Update** - Create and maintain control charts if you have 20-30 data points within 90 days.
  - If you do not meet the above criteria, follow QC Acceptance Criteria below.
    - Blanks < MDL
    - LFB  $\pm$  15%
    - ICV/CCV  $\pm$  10%
    - LFM/LFMD  $\pm$  20%
    - RPD < 20%
    - Reporting limit = MDL

TDEC - Fleming Training Center 44

### Common Errors

- Sampling error
- Failure to analyze within holding
- Failure to use the correct method
- Failure to follow the method
- Failure to analyze the correct QC
- Calculation errors
- Standards or Reagents prepared incorrectly or expired

TDEC - Fleming Training Center 45

### Procedural Concerns



- Ammonia distillation apparatus should be steamed out

TDEC - Fleming Training Center 46

### Procedural Concerns

- TKN
  - Samples must be preserved in acid as specified in Sample collection and storage on p. 2 (Hach method)
  - Close each reagent bottle immediately after use
  - **\*\*Do not discard undigested sample!** You will need it later for test vial 2 (green label)

TDEC - Fleming Training Center 47

### Procedural Concerns



- TKN & Total Phosphorus standards should be digested along with samples
- Phosphorus analyses require dedicated glassware

TDEC - Fleming Training Center 48

## Procedural Concerns

- Copper-Cadmium column
- Measures the amount of both Nitrate and Nitrite-N by reducing all Nitrate to Nitrite
- should be conditioned before use
- Verify efficiency of the cadmium column to reduce Nitrate to Nitrite

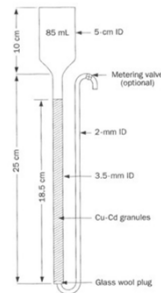

Figure 4506-NO<sub>3</sub>-11. Reduction column.

TDEC - Fleming Training Center 49

## Bench Sheet Information

- Analysis & Method Number
- Analyst Initials and Date of Analysis
- Time of analysis (verify holding times)
- Sample ID
- Sample volumes used in prep/distillation
- Units
- Instrument used
- True Value of QC Samples

TDEC - Fleming Training Center 50

Any Questions?

TDEC - Fleming Training Center 51

## Nutrients – Review Questions

### Laboratory portion:

1. Which Hach Methods did we use in lab to analyze phosphorus?
2. Why does the Total Phosphorus test require a 1 hour digestion?
3. The Hach Method 10209/10210 TNTplus843 (and the Standard Method 4500-P E.) uses which type of acid to produce the intense (molybdenum) blue color?
4. In order to directly measure the amount of phosphate, all types must be first converted into one form of phosphate, and then measured using a colorimetric method. Which is the only form that can be measured directly?
5. Samples to be analyzed for phosphorus must be collected in clean glass or plastic bottles that have been cleaned with 6N hydrochloric acid and rinsed with deionized water. Why? Also, why is it important to use laboratory grade/phosphate free detergent?
6. What results are produced from the simplified TKN test?
7. Why does the simplified TKN method use 2 vials, one with digested sample and one without?

### Classroom portion:

8. What are the three most important nutrients in wastewater?



# Understanding the Different Phosphorus Tests

By **Bob Dabkowski**, Application Development Manager, Hach  
**Melody White**, Application Development Manager, Hach

## Introduction

In wastewater treatment, phosphorus testing can quickly become confusing. For example, there are three different tests. So, which test was performed? Test results can be displayed in two different forms. So, which form was utilized? Tests can measure both particulate and dissolved phosphorus. So, was the sample filtered?

Knowing which test to run, which units of measurement to choose, and how to express the result can be overwhelming for even the most seasoned chemist. This application note is designed to cut through the noise and confusion by applying simple, easy-to-understand information for the non-chemist about the different forms and analytical methods for phosphorus in water—so that you can choose the right test and communicate the results confidently.

## Testing for Phosphorus

The three ways to test for phosphorus in water are:

- The orthophosphate test
- The acid hydrolyzable phosphate test
- The total phosphorus test.

Elemental phosphorus never occurs by itself in water, but always as some type of compound. These tests use different techniques to measure the three main types of phosphorus in water:

- Orthophosphate
- Condensed phosphate
- Organic phosphate.

It's important to note that only orthophosphate can be measured directly. The other forms must be digested in either an acid or an acid plus an oxidant in order to convert them to orthophosphate so they can be measured. These types of phosphorus can be either dissolved or particulate forms so it is critical when discussing results to make sure you know if the sample was filtered first (dissolved) or not (dissolved + particulate), and what type of filter was used.

For example, a paper filter with a pore size of 0.45µm will remove all the particles, but a glass fiber filter with a pore size of 1.5µm will allow some particles through which could show up as phosphorus. Just remember: More documentation is always better than less when it comes to describing the testing procedure you use!

## Orthophosphate

### Structure

Orthophosphate is one phosphorus atom bonded to four oxygen atoms as shown in Figure 1.

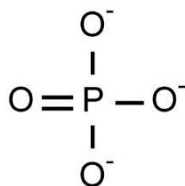

Figure 1:  
Orthophosphate structure

Orthophosphate is also called “phosphate” and “reactive phosphorus” because it is very easy to make it bond with other positive elements and compounds since it has three “extra” electrons that strongly want to bond with protons.

### Methods

The two common colorimetric methods of measuring orthophosphate are:

- Ascorbic Acid/“Blue” Method
- Molybdovanadate/“Yellow” Method.

Both methods combine orthophosphate with molybdate in an acidic environment but differ in how they form the final compound, which creates the blue or yellow color. Be aware that no analytical test is perfect, and some condensed phosphate may be measured with these tests too. Due to the acidic chemistry, some particulate orthophosphate may be detected if the sample was not first filtered to 0.45 micron. To measure all of the particulate orthophosphate it is necessary to use a total phosphorus test which incorporates a rigorous digestion to convert most of the particulate phosphate to dissolved phosphate.

### Forms

Orthophosphate can be displayed in two different ways:

- $\text{PO}_4^{3-}$  spoken as “orthophosphate”
- $\text{PO}_4\text{-P}$  spoken as “orthophosphate as phosphorus.”

The difference between the two is very important.  $\text{PO}_4^{3-}$  results combine both the phosphorus and the oxygen in the compound, whereas  $\text{PO}_4\text{-P}$  only considers the phosphorus in the compound.

Think of it this way: if you were “farming” bacteria, and they only ate phosphorus, you would want to know exactly how much edible phosphorus is in your feed. You wouldn't care how much oxygen is bound with the phosphorus because the bacteria don't care either. You would display your results as  $\text{PO}_4\text{-P}$ . If you were



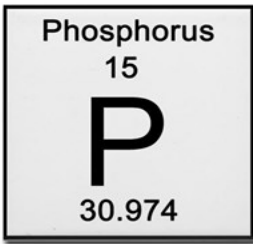

farming some different bacteria and they ate both the phosphorus and the oxygen too, you would display your results as  $PO_4^{3-}$ .

The nice part is you can convert from  $PO_4\text{-P}$  to  $PO_4^{3-}$  with simple multiplication. Multiply the  $PO_4\text{-P}$  result by 3.06 to display the result as  $PO_4^{3-}$ . For example,  $1.0 \text{ mg/L } PO_4\text{-P} = 3.06 \text{ mg/L } PO_4^{3-}$ . Why does this work? The answer is simple, and is due to the relative weights of both compounds:  $PO_4^{3-}$  is 3.06 times "heavier" than  $PO_4\text{-P}$ .

If you want to figure out the ratio for yourself, you first need to determine how "heavy" a molecule of orthophosphate is, so off you go to the periodic chart and find the molecular weights of phosphorus and oxygen. Phosphorus weighs 31 atomic units, and oxygen weighs 16. Since there is one phosphorus and four oxygen in the orthophosphate compound, you add the weight of four oxygen to one phosphorus to determine the total weight:

$$16 * 4 = 64$$

$$64 + 31 = 95$$

One molecule of orthophosphate weighs 95 atomic units. To determine the multiplication factor required to convert between the two species, you then divide the total weight by the weight of just the phosphorus:

$$95 / 31 = 3.06$$

In other words, the entire orthophosphate compound is 3.06 times heavier than just the phosphorus by itself.

It's important to realize that the test itself only measured orthophosphate, so this 3.06 ratio only converts the orthophosphate results between the two species. It does not change the results to total phosphorus—that is an entirely different test requiring a digestion with sulfuric acid and potassium persulfate. It's easy to be confused by this, but the simple way to know what the results represent is to ask the analyst if he/she performed a digestion first. If the answer is "No," then you know the results are just orthophosphate and not total phosphorus.

## The Copper Wire Analogy

Here is a handy way to think about orthophosphate vs orthophosphate as phosphorus...

Pretend that your electrician friend gives you a large box full of insulated copper wire. You don't need the wire, but you know you might be able to make some money by bringing it to a scrap yard and selling the copper.

You bring the box of wire down to the scrap yard, and the owner says he'll pay you \$5.00 for each pound of copper. Off to the scales you go, and after dumping the entire box of insulated wire on the scale you see the display showing 10 lbs.

Not a bad way to make \$50. But, the owner pushes the wire off the scale; cuts off a five foot long piece, and puts it back on the scale weighing in at 3.06 pounds. He then pulls out a knife and strips the insulation off the five foot long piece of wire, and weighs just the copper core—which weighs exactly 1 lb.

"I'll give you \$16.34 for the whole box," he says.

"Wait!" you say. "The total weight was 10 lbs.! That's worth \$50!"

"I only pay for the copper, not the insulation. For each 3.06 pounds of insulated wire there was only a pound of copper. Ten pounds divided by 3.06 equals 3.27, times \$5 a pound is \$16.34."

Then you think to yourself, "I get it—I thought of it as 'wire as wire' while he thinks of it as 'wire as copper'. Just like orthophosphate and orthophosphate as phosphorus!"

## Acid Hydrolyzable Phosphate/Condensed Phosphate

### Structure

Condensed phosphates are multiple orthophosphate molecules "condensed" together and sharing a covalent bond between adjoining phosphorus (P) and oxygen (O) atoms. This group includes metaphosphate, pyrophosphate, and polyphosphate—which are often used for corrosion control in drinking water distribution systems. Examples of their respective structures are shown in Figure 2.

### Methods



In order to measure condensed phosphates, it is first necessary to transform them into orthophosphate using a sulfuric acid and heat, digesting the sample at 150°C for 30 minutes. This is also called "Acid Hydrolyzable Phosphate" since the condensed phosphates are hydrolyzed into orthophosphate. After the

digestion, either the ascorbic acid or molybdovanadate methods are used to measure the orthophosphate. Some organic phosphate will also be hydrolyzed into orthophosphate so the results are not "pure" condensed phosphate.

Of course, just performing the digestion and colorimetric test will tell you the concentration of both the original orthophosphate and condensed phosphates. If you want just the condensed phosphate concentration then simply run the orthophosphate test on the same sample without a digestion and subtract those results from the first concentration.

### Forms

Condensed phosphates are displayed just as orthophosphate, since the analytical method changes them into orthophosphate molecules. Therefore, either  $\text{PO}_4^{3-}$  or  $\text{PO}_4\text{-P}$  may be used to describe the results, as long as the same rules are followed as described for orthophosphate.

## Total Phosphorus/Organic Phosphate

### Structure

Organic phosphates are any phosphates contained inside or bonded to an organic compound. In the same sample, total phosphorus concentrations will always be larger than the orthophosphate concentration. A popular form that most people are familiar with is adenosine triphosphate (ATP), which is considered the "molecular unit of currency" of energy transfer between cells inside our body. The structure of organic phosphates is shown in Figure 3. Note that the letter "R" is a typical proxy for any organic, carbon-based molecule.

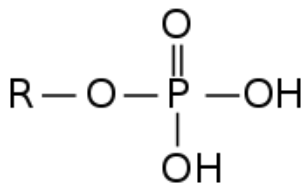

Figure 3: Organic phosphate

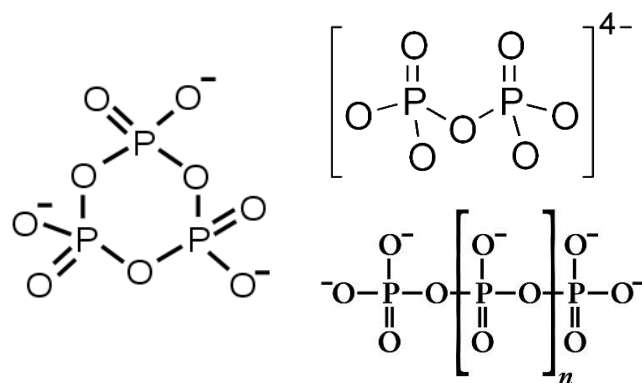

Figure 2: Examples of metaphosphate (left), pyrophosphate (top right), and polyphosphate structure (bottom right)

### Methods

Organic phosphates are stubborn compounds that do not like to break down easily. In order to test for them, it is necessary to not only digest the sample first with sulfuric acid and heat, but also add a strong oxidant such as potassium persulfate to break the orthophosphates free from the organic bonds. After digestion, the same ascorbic acid or molybdovanadate methods can be used to measure the concentration. The test just described will convert all of the different forms of phosphate into orthophosphate, which means the results are total phosphorus! If you want to know only the organically bound phosphate concentration, it is necessary to perform the acid hydrolyzable test and subtract those results from the total phosphorus concentration.

### Forms

Total phosphorus is typically displayed as a simple "P." For example: 1.0mg/L P means the test that was performed included an acid persulfate digestion at 100°C for 60 minutes followed by the ascorbic acid or molybdovanadate colorimetric test. Since most spectrophotometers and colorimeters have no way of knowing if you digested the sample or not, they will often display the result as  $\text{PO}_4\text{-P}$  or  $\text{PO}_4^{3-}$ . It is important to make sure that if you want to record your units as "P" that the spectrophotometer is set up to display as  $\text{PO}_4\text{-P}$ . If it is showing as  $\text{PO}_4^{3-}$  then it is necessary to convert back to  $\text{PO}_4\text{-P}$  by dividing your results by 3.06 as described earlier in the orthophosphate section.

## Summary

Measuring phosphorus in water and discussing the results is easy to do if you accurately communicate how the sample was prepared and which test was performed. Often, we make this much harder than it needs to be by swapping forms or changing units without considering the consequences. The table below summarizes the different phosphorus tests, digestion requirements and reagents so that in a pinch you can ask clarifying questions to make sure everyone is communicating on the same page.

Table: Phosphorus tests, digestion requirements and reagents

	Orthophosphate	Acid Hydrolyzable	Total Phosphorus
Digestion?	No	Sulfuric Acid + 150°C for 30 minutes	Sulfuric Acid + Potassium Persulfate + 100°C for 60 minutes
Typical Units	PO <sub>4</sub> <sup>3-</sup> or PO <sub>4</sub> -P	PO <sub>4</sub> <sup>3-</sup> or PO <sub>4</sub> -P	P
Reagents	Ascorbic Acid or Molybdovanadate	Ascorbic Acid or Molybdovanadate	Ascorbic Acid or Molybdovanadate

### References:

*Methods for Wastewater Characterization in Activated Sludge Modelling (2003), Water Environment Research Foundation, Alexandria, VA*

*Water Analysis Handbook, 8th Edition (2013) Hach, Loveland, CO*

### HACH World Headquarters: Loveland, Colorado USA

United States: 800-227-4224 tel 970-669-2932 fax orders@hach.com  
 Outside United States: 970-669-3050 tel 970-461-3939 fax int@hach.com

[hach.com](http://hach.com)

©Hach Company, 2015. All rights reserved.  
 In the interest of improving and updating its equipment, Hach Company reserves the right to alter specifications to equipment at any time.





# Phosphorus, Reactive (Orthophosphate) and Total

## Ascorbic Acid Method

Method 10209/10210

0.15 to 4.50 mg/L PO<sub>4</sub><sup>3-</sup> or 0.05 to 1.50 mg/L PO<sub>4</sub><sup>3-</sup>-P (LR)

TNTplus® 843

**Scope and application:** For wastewater, drinking water, boiler water, surface water and process water.



### Test preparation

## Instrument-specific information

Table 1 shows all of the instruments that have the program for this test. The table also shows the adapter and light shield requirements for the applicable instruments that can use TNTplus vials.

To use the table, select an instrument, then read across to find the applicable information for this test.

**Table 1 Instrument-specific information for TNTplus vials**

Instrument	Adapters	Light shield
DR 6000, DR 5000	—	—
DR 3900	—	LZV849
DR 3800, DR 2800	—	LZV646
DR 1900	9609900 or 9609800 (A)	—

## Before starting

DR 3900, DR 3800, DR 2800: Install the light shield in Cell Compartment #2 before this test is started.

Review the safety information and the expiration date on the package.

The recommended sample pH is 2–10.

The recommended temperature for samples and reagents is 15–25 °C (59–77 °F).

The recommended temperature for reagent storage is 15–25 °C (59–77 °F).

The reagents that are used in this test contain molybdenum and are corrosive. Collect the reacted samples for proper disposal.

Use the DRB reactor with 13-mm wells for the digestion. If the reactor has 16-mm wells, insert adapter sleeves into the wells.

DR 1900: Go to All Programs>LCK or TNTplus Methods>Options to select the TNTplus number for the test. Other instruments automatically select the method from the barcode on the vial.

Review the Safety Data Sheets (MSDS/SDS) for the chemicals that are used. Use the recommended personal protective equipment.

Dispose of reacted solutions according to local, state and federal regulations. Refer to the Safety Data Sheets for disposal information for unused reagents. Refer to the environmental, health and safety staff for your facility and/or local regulatory agencies for further disposal information.

## Items to collect

Description	Quantity
Phosphorus, Reactive and Total LR TNTplus Reagent Set	1
DRB200 reactor with 13-mm wells	1

## Items to collect (continued)

Description	Quantity
Pipet, adjustable volume, 1.0–5.0 mL	1
Pipet, adjustable volume, 0.2–1.0 mL	1
Pipet tips	1
Test tube rack	1

Refer to [Consumables and replacement items](#) on page 7 for order information.

## Sample collection and storage

- Collect samples in clean glass or plastic bottles that have been cleaned with 6 N (1:1) hydrochloric acid and rinsed with deionized water.
- Analyze the samples as soon as possible for best results.
- Do not use a detergent that contains phosphate to clean the sample bottles. The phosphate in the detergent will contaminate the sample.
- To preserve samples for later analysis, adjust the sample pH to 2 or less with concentrated sulfuric acid (approximately 2 mL per liter). Do not acidify samples to be analyzed only for reactive phosphorus. No acid addition is necessary if the sample is tested immediately.
- Keep the preserved samples at or below 6 °C (43 °F) for a maximum of 28 days (reactive phosphorus only: 48 hours).
- Let the sample temperature increase to room temperature before analysis.
- Before analysis, adjust the pH to 7 with 5 N sodium hydroxide solution.
- Correct the test result for the dilution caused by the volume additions.

## Test procedure—total phosphorus

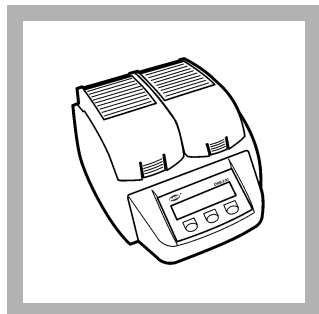

1. Set the DRB200 reactor power to on. Set the temperature to 100 °C.

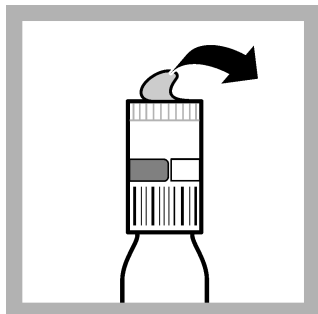

2. Carefully remove the lid from the DosiCap™ Zip cap. Remove the cap from the test vial.



3. Use a pipet to add 2.0 mL of sample to the test vial.

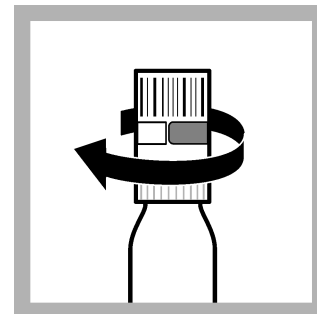

4. Turn the DosiCap Zip over so that the reagent side goes on the test vial. Tighten the cap on the vial.

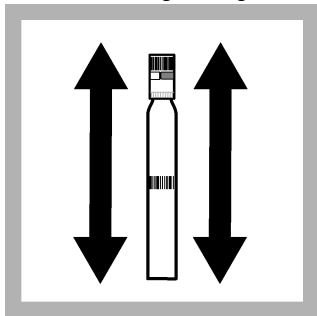

**5.** Shake the vial 2–3 times to dissolve the reagent in the cap.  
Look through the open end of the DosiCap to make sure that the reagent has dissolved.

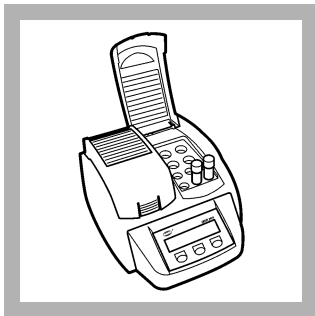

**6.** Insert the vial in the preheated DRB200 reactor. Close the lid.



**7.** Keep the vial in the reactor for 1 hour.

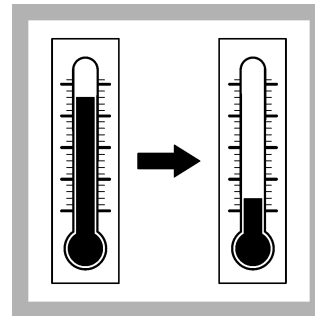

**8.** When the timer expires, carefully remove the vial from the reactor. Set the vial in a test tube rack. Let the temperature of the vial decrease to room temperature.

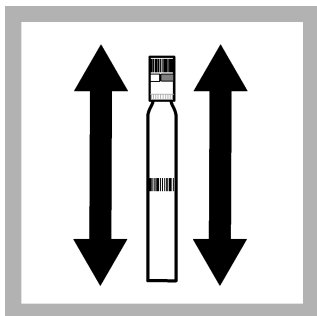

**9.** Shake the vial 2–3 times.

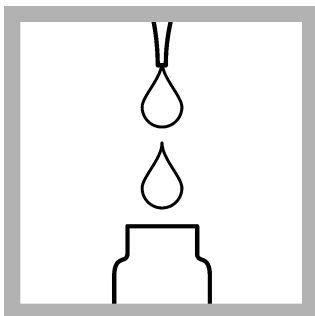

**10.** Use a pipet to add 0.2 mL of Solution B to the test vial. Immediately tighten the cap on the Solution B container.

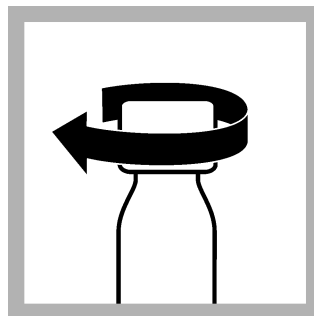

**11.** Put a grey DosiCap C on the vial.

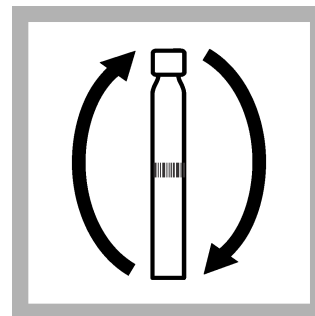

**12.** Tighten the cap on the vial and invert the vial 2–3 times.



**13.** Start the reaction time of 10 minutes.

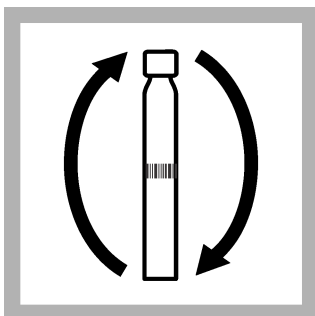

**14.** When the timer expires, invert the vial 2–3 times.

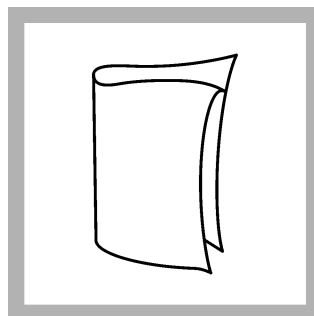

**15.** Clean the vial.

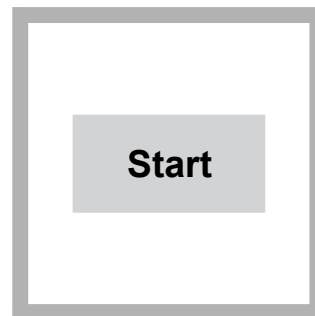

**16.** DR 1900 only: Select program 843. Refer to [Before starting](#) on page 1.



17. Insert the vial into the cell holder. DR 1900 only: Push **READ**. Results show in mg/L  $\text{PO}_4^{3-}$ .

### Test procedure—reactive phosphorus

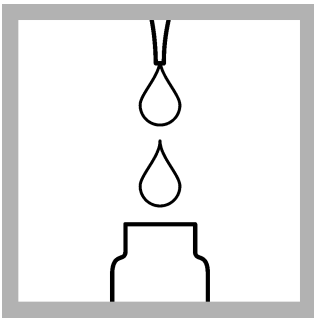

1. Use a pipet to add 2.0 mL of sample to the test vial.

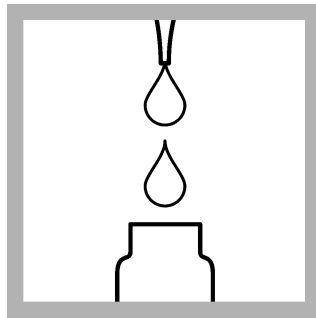

2. Use a pipet to add 0.2 mL of Solution B to the test vial. Immediately tighten the cap on the Solution B container.

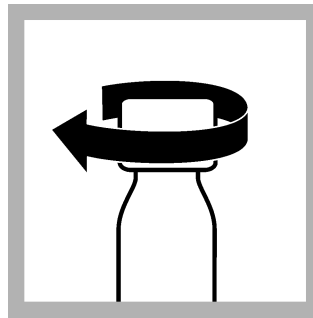

3. Put a grey DosiCap C on the vial.

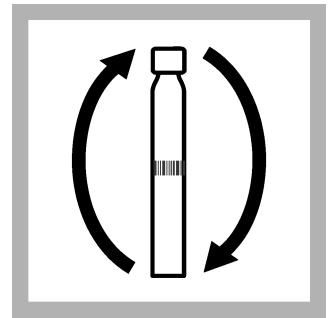

4. Tighten the cap on the vial and invert the vial 2–3 times.



5. Start the reaction time of 10 minutes.

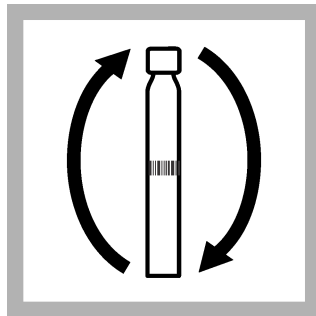

6. When the timer expires, invert the vial 2–3 times.

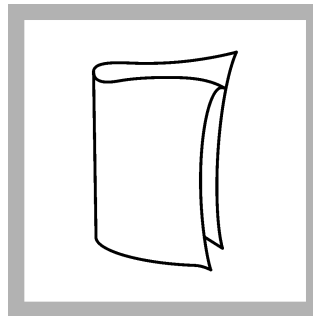

7. Clean the vial.

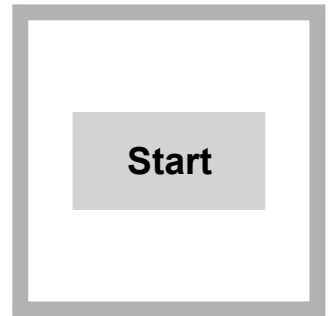

8. DR 1900 only: Select program 843. Refer to [Before starting](#) on page 1.

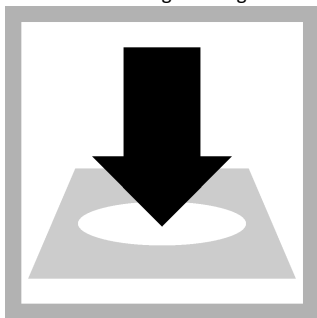

9. Insert the vial into the cell holder. DR 1900 only: Push

**READ.**

Results show in mg/L  
PO<sub>4</sub><sup>3-</sup>.

### Reagent blank correction

For the best results, measure the reagent blank value for each new lot of reagent. Replace the sample with deionized water in the test procedure to determine the reagent blank value. Subtract the reagent blank value from the sample results automatically with the reagent blank adjust option. Measure the reagent blank value when a new lot of reagent is used.

1. Use deionized water as the sample in the test procedure to measure the reagent blank value.
2. Set the reagent blank function to on. The measured reagent blank value is shown.
3. Accept the blank value. The reagent blank value is then subtracted from all results until the reagent blank function is set to off or a different method is selected.

**Note:** As an alternative, record or enter the reagent blank value at a different time. Push the highlighted reagent blank box and use the keypad to enter the value.

### Sample blanks

Samples with color or turbidity can cause high results. Samples without color or turbidity do not require sample blanks. The digestion in the total phosphate test procedure usually removes all color and turbidity. A sample blank is not required. To adjust for color or turbidity in the reactive phosphate test procedure, use the steps that follow to find the sample blank.

1. Do the test procedure, but do not add the DosiCap C.
2. Put the cap on the vial, but do not remove the foil. Use the side of the cap that does not have the reagent.
3. Subtract the value from the final procedure step from the initial sample value to get the corrected sample concentration.

**Note:** Alternatively, samples that contain only turbidity can be filtered through a membrane filter, then analyzed.

### Interferences

Table 2 shows that the ions were individually examined to the given concentrations and do not cause interference. No cumulative effects or influences of other ions were found. Verify the measurement results with sample dilutions or standard additions.

**Table 2 Interfering substances**

Interfering substance	Interference level
SO <sub>4</sub> <sup>2-</sup>	5000 mg/L
Cl <sup>-</sup>	2000 mg/L
K <sup>+</sup> , Na <sup>+</sup>	1000 mg/L

**Table 2 Interfering substances (continued)**

Interfering substance	Interference level
NO <sub>3</sub> <sup>-</sup>	500 mg/L
Ca <sup>2+</sup>	250 mg/L
Mg <sup>2+</sup>	100 mg/L
CO <sub>3</sub> <sup>2-</sup> , Fe <sup>2+</sup> , Fe <sup>3+</sup> , Zn <sup>2+</sup> , Cu <sup>2+</sup> , Ni <sup>2+</sup> , I <sup>-</sup> , NO <sub>2</sub> <sup>-</sup> , Cd <sup>2+</sup> , NH <sub>4</sub> <sup>+</sup> , Mn <sup>2+</sup> , Al <sup>3+</sup> , SiO <sub>2</sub>	50 mg/L
Sn <sup>4+</sup> , Hg <sup>2+</sup>	5 mg/L
Ag <sup>+</sup> , Pb <sup>2+</sup>	2.5 mg/L
Cr <sup>3+</sup>	1 mg/L
Cr <sup>6+</sup>	0.5 mg/L

## Accuracy check

### Standard solution method

Use the standard solution method to validate the test procedure, the reagents and the instrument.

Items to collect:

- Phosphate Standard Solution, 3-mg/L PO<sub>4</sub><sup>3-</sup> or Wastewater Effluent Standard Solution, Mixed Parameter (contains 2-mg/L PO<sub>4</sub><sup>3-</sup>)
1. Use the test procedure to measure the concentration of the standard solution.
  2. Compare the expected result to the actual result.

**Note:** The factory calibration can be adjusted slightly with the standard adjust option so that the instrument shows the expected value of the standard solution. The adjusted calibration is then used for all test results. This adjustment can increase the test accuracy when there are small variations in the reagents or instruments.

### Method performance

The method performance data that follows was derived from laboratory tests that were measured on a spectrophotometer during ideal test conditions. Users can get different results under different test conditions.

Program	Standard	Precision (95% confidence interval)	Sensitivity Concentration change per 0.010 Abs change
barcode	3.50 mg/L PO <sub>4</sub> <sup>3-</sup>	3.39–3.61 mg/L PO <sub>4</sub> <sup>3-</sup>	—

### Summary of Method

Phosphates in organic and condensed inorganic forms (meta-, pyro- or other polyphosphates) are first converted to reactive orthophosphate in the total phosphorus procedure. Treatment of the sample with acid and heat provides the conditions for hydrolysis of the condensed inorganic forms. Organic phosphates are also converted to orthophosphates in the total phosphorus procedure by heating with acid and persulfate. The reactive phosphorus procedure measures only the reactive (ortho) phosphorus that are in the sample. The reactive or orthophosphate ions react with molybdate and antimony ions in an acidic solution to form an antimonyl phosphomolybdate complex, which is reduced by ascorbic acid to phosphomolybdenum blue. The measurement wavelength is 880 nm (DR 1900: 714 nm).

## Consumables and replacement items

### Required reagents

Description	Quantity/Test	Unit	Item no.
Phosphorus, Reactive and Total LR TNTplus Reagent Set	1	25/pkg	TNT843

### Required apparatus

Description	Quantity/test	Unit	Item no.
DRB 200 Reactor, 115 VAC option, 9 x 13 mm + 2 x 20 mm, 1 block	1	each	DRB200-01
DRB 200 Reactor, 230 VAC option, 9 x 13 mm + 2 x 20 mm, 1 block	1	each	DRB200-05
Pipet, adjustable volume, 1.0–5.0 mL	1	each	BBP065
Pipet tips, for 1.0–5.0 mL pipet	1	75/pkg	BBP068
Pipet, adjustable volume, 0.2–1.0 mL	1	each	BBP078
Pipet tips, for 0.2–1.0 mL pipet	2	100/pkg	BBP079
Test tube rack	1	each	1864100
Light shield, DR 3800, DR 2800, DR 2700	1	each	LZV646
Light shield, DR 3900	1	each	LZV849

### Recommended standards

Description	Unit	Item no.
Phosphate Standard Solution, 3-mg/L as $\text{PO}_4^{3-}$	946 mL	2059716
Wastewater Effluent Standard Solution, Mixed Parameter, for $\text{NH}_3\text{-N}$ , $\text{NO}_3\text{-N}$ , $\text{PO}_4^{3-}$ , COD, $\text{SO}_4^{2-}$ , TOC	500 mL	2833249

### Optional reagents and apparatus

Description	Unit	Item no.
Filter membrane, 0.45-micron, 25-mm	100/pkg	2514101
Flask, volumetric, Class A, 1000 mL glass	each	1457453
Hydrochloric Acid Solution, 6.0 N (1:1)	500 mL	88449
Reactor adapter sleeves, 16 mm to 13 mm diameter, for TNTplus vials	5/pkg	2895805
Sampling bottle with cap, low density polyethylene, 500-mL	12/pkg	2087079
Sodium Hydroxide Standard Solution, 5.0 N	100 mL MDB	245032
Sulfuric Acid, concentrated, ACS	500 mL	97949



**FOR TECHNICAL ASSISTANCE, PRICE INFORMATION AND ORDERING:**  
In the U.S.A. – Call toll-free 800-227-4224  
Outside the U.S.A. – Contact the HACH office or distributor serving you.  
On the Worldwide Web – [www.hach.com](http://www.hach.com); E-mail – [techhelp@hach.com](mailto:techhelp@hach.com)

**HACH COMPANY**  
WORLD HEADQUARTERS  
Telephone: (970) 669-3050  
FAX: (970) 669-2932



## Phosphorus Total Phosphorus Reactive (ortho)

pH of sample: 2 – 10

Temperature of sample/reagent: 15 – 25°C

0.05 – 1.50 mg/L PO<sub>4</sub>-P

0.15 – 4.50 mg/L PO<sub>4</sub>

Low Range



### Special Notes (For more detailed information: HACH Procedure Manual)

- Please read **Safety Advice** and **Expiration Date** on package.
- **Range of application:** For wastewater, drinking water, boiler water, surface water and process analysis
- If test is not performed at the **recommended temperature** an **incorrect** result may be obtained.
- A blue color will develop if phosphorus is present.
- **DR 1900:** Select Program **843**.

**1 – 9**

**Phosphorus Total**

**2, 7 – 9**

**Phosphorus Reactive (ortho)**

**1**

DosiCap™ Zip

Remove foil cap and unscrew DosiCap™ Zip

**2**

Add **2.0 mL** Sample

**3**

Flip over DosiCap™ Zip and Tighten

**4**

Shake 2 – 3x

**5**

Heat **100°C** **1h**

**6**

Cool Shake 2 – 3x

**7**

Add **0.2 mL** **B**

**8**

Apply DosiCap™ C

**9**

Invert 2 – 3x

Read

For Phosphorus Total perform steps **1 – 9**. For Phosphorus Reactive (ortho) perform steps **2** and **7 – 9**.

**Carefully** remove the foil from the **DosiCap™ Zip** and unscrew cap.

Pipet **2.0 mL** of sample into the vial.

Screw the **DosiCap™ Zip** back on.

Shake **firmly** 2 – 3 times.

Heat **one hour** at 100°C in the reactor.

Shake the **cooled** vial **firmly** 2 – 3 times.

Pipet into the vial: **0.2 mL** Reagent **B**. Close Reagent B **immediately** after use.

Screw a **grey DosiCap™ C** onto the vial.

Invert 2 – 3 times. After **10 minutes** invert again 2 – 3 times. Thoroughly clean the outside of the vial and insert it into the photometer. The **barcode** is identified, an **automatic evaluation** is carried out after the vial is inserted.

Principle	Interferences		
Phosphate ions react with molybdate and antimony ions in an acidic solution to form an antimonyl phosphomolybdate complex, which is reduced by ascorbic acid to phosphomolybdenum blue.	The ions listed below have been individually checked up to the given concentrations and do not cause interference. We have not determined cumulative effects and the influence of other ions. Measurement results can be verified using sample dilutions or standard additions.		
	5000 mg/L: SO <sub>4</sub> <sup>2-</sup>	250 mg/L: Ca <sup>2+</sup>	5 mg/L: Sn <sup>4+</sup> , Hg <sup>2+</sup>
	2000 mg/L: Cl <sup>-</sup>	100 mg/L: Mg <sup>2+</sup>	2.5 mg/L: Ag <sup>+</sup> , Pb <sup>2+</sup>
	1000 mg/L: K <sup>+</sup> , Na <sup>+</sup>	50 mg/L: Co <sup>2+</sup> , Fe <sup>2+</sup> , Fe <sup>3+</sup> , Zn <sup>2+</sup> , Cu <sup>2+</sup> , Ni <sup>2+</sup> , I <sup>-</sup> , NO <sub>2</sub> <sup>-</sup> , Cd <sup>2+</sup> , NH <sub>4</sub> <sup>+</sup> , Mn <sup>2+</sup> , Al <sup>3+</sup> , CO <sub>3</sub> <sup>2-</sup> , SiO <sub>2</sub>	1 mg/L: Cr <sup>3+</sup>
	500 mg/L: NO <sub>3</sub> <sup>-</sup>		0.5 mg/L: Cr <sup>6+</sup>

**Note:** For more detailed information see the HACH Procedure Manual.

# Phosphorous

For water, wastewater and seawater

Amino Acid, Ascorbic Acid and  
Molybdovanadate Methods

## Introduction

Phosphorus occurs in natural water and wastewaters almost solely as phosphates. Phosphates may enter water from agricultural run-off and as biological and industrial wastes. They may be added to water in municipal and industrial water treatment processes to control corrosion. A certain amount of phosphate is essential for most plants and animals, but too much phosphate in water can contribute to eutrophication, especially when large amounts of nitrogen are also present.

Phosphorus can be classified as orthophosphate, condensed phosphate or organically bound phosphate. Condensed phosphates are formed by dehydrating the orthophosphate radical; they include metaphosphate, pyrophosphate and polyphosphate. The only form of phosphate determined directly is orthophosphate; other forms require pretreatment for conversion to orthophosphate for analysis. When no pretreatment is used, phosphate analyses determine Reactive Phosphorus. Reactive phosphorus is a measure of orthophosphate, plus a small fraction of condensed phosphate that may have been hydrolyzed during the test.

Hach offers high and low range tests for reactive phosphorus. High range tests can be completed with the Amino Acid Method or the Molybdovanadate Method. The Molybdovanadate Method uses a single reagent and has a faster reaction than the Amino Acid Method. Both methods have a broad range and are free from most interferences. Low range tests use the Ascorbic Acid Method.

Condensed phosphates plus orthophosphate can be determined by acid hydrolysis using sulfuric acid, followed by the reactive phosphorus test for the appropriate range. A small amount of organically bound phosphorus will be included in this measurement. The results of the test are reported as acid-hydrolyzable phosphorus. Total phosphorus (orthophosphate, condensed and organically bound) can be determined by acid oxidation with persulfate, followed by the reactive phosphorus test. Organically bound phosphate can then be determined by subtracting the acid-hydrolyzable phosphorus.

## Chemical reactions

### Pretreatment steps

Reactions for pretreatment to determine acid-hydrolyzable and total phosphorus are illustrated below:

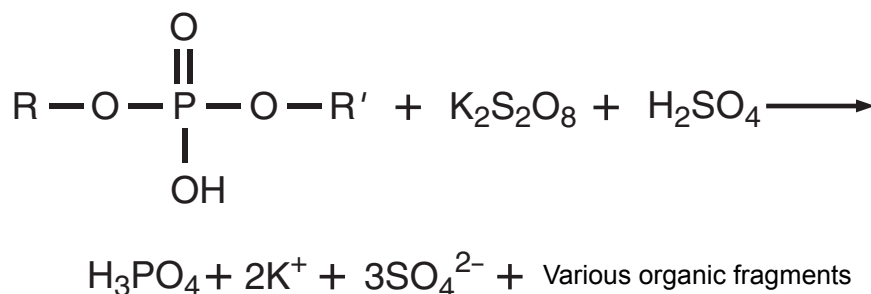
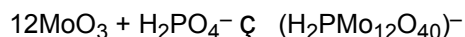

Figure 1 Example of potassium persulfate oxidation of organically bound phosphorus<sup>1</sup>

<sup>1</sup> R and R' represent various organic groups

**Amino acid and ascorbic acid methods**

Reactive phosphorus is determined in essentially two steps for either the Ascorbic Acid Method (low range) or the Amino Acid Method (high range). The first step involves reaction of orthophosphate with molybdate in acid solution, which forms a yellow-colored phosphomolybdate complex:



The phosphomolybdate complex is then reduced by either an amino acid or ascorbic acid, causing a characteristic molybdenum blue species. Various structures for the molybdenum blue species have been suggested in the literature. For example, see Killeffer, D. H., *Molybdenum Compounds-Their Chemistry and Technology*, Interscience Publishers, 1952.

All reagents for the Ascorbic Acid Method are contained in PhosVer™3 Reagent Powder Pillows. Reagents for the Amino Acid Method are contained in Amino Acid Reagent Solution and Molybdate Reagent Solution.

**Molybdovanadate method**

Reactive phosphorus combines with molybdate in an acid medium to form a phosphomolybdate complex. Vanadium, contained in Molybdovanadate Reagent, reacts with the complex to form vanadomolybdophosphoric acid. Intensity of the resulting yellow color is proportional to the concentration of reactive phosphorus. One possible formula for the complex is suggested below. The exact structure is not known.

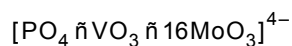

# Nitrogen, Simplified TKN (s-TKN™)

s-TKN™ Method

Method 10242<sup>1</sup>

0 to 16 mg/L TKN

TNTplus™ 880

**Scope and application:** For water and wastewater. Digestion is required.

<sup>1</sup> USEPA approved for water and wastewater analysis, 40 CFR part 136.



## Test preparation

### Instrument-specific information

[Table 1](#) shows all of the instruments that have the program for this test. The table also shows the adapter and light shield requirements for the applicable instruments that can use TNTplus vials.

To use the table, select an instrument, then read across to find the applicable information for this test.

**Table 1 Instrument-specific information for TNTplus vials**

Instrument	Adapters	Light shield
DR 6000, DR 5000	—	—
DR 3900	—	LZV849
DR 3800, DR 2800	—	LZV646
DR 1900	9609900 or 9609800 (A)	—

### Before starting

DR 3900, DR 3800, DR 2800: Install the light shield in Cell Compartment #2 before this test is started.

Review the safety information and the expiration date on the package.

The sample temperature must be 15–25 °C (59–77 °F) for accurate results.

The recommended temperature for reagent storage is 15–25 °C (59–77 °F).

Samples must be preserved with acid as specified in [Sample collection and storage](#) on page 2. Make sure to adjust the pH and temperature before the analysis.

Important: Make sure to close each reagent bottle immediately after each use.

The 20-mm reaction tube can be used for 7 tests. After each use, clean the tube thoroughly with a brush and water, then rinse well with high-quality distilled water and let dry.

If a large amount of turbidity forms after the addition of MicroCap C, let the turbidity settle, then go to the next step. A small amount of turbidity does not interfere.

The nitrite concentration can be determined with nitrite reagents on samples that have not been preserved. The nitrite concentration must then be subtracted from the s-TKN result.

The total nitrogen concentration must be between 1 and 16 mg/L N. The combined nitrate/nitrite concentration must be between 0.23 and 13.5 mg/L N. Dilute the sample if necessary.

DR 1900: Go to All Programs>LCK or TNTplus Methods>Options to select the TNTplus number for the test. Other instruments automatically select the method from the barcode on the vial.

Review the Safety Data Sheets (MSDS/SDS) for the chemicals that are used. Use the recommended personal protective equipment.

Dispose of reacted solutions according to local, state and federal regulations. Refer to the Safety Data Sheets for disposal information for unused reagents. Refer to the environmental, health and safety staff for your facility and/or local regulatory agencies for further disposal information.

## Items to collect

Description	Quantity
s-TKN TNTplus Reagent Set	1
DRB200 reactor with 20-mm wells	1
Pipet, adjustable volume, 1.0–5.0 mL	1
Pipet, adjustable volume, 0.2–1.0 mL	1
Pipet tips	1
Test tube rack	1

Refer to [Consumables and replacement items](#) on page 5 for order information.

## Sample collection and storage

- Collect samples in clean glass or plastic bottles.
- Adjust the sample pH to less than 2 with concentrated sulfuric acid (approximately 2 mL per liter).
- Keep the preserved samples at or below 6 °C (43 °F) for a maximum of 28 days.
- Let the sample temperature increase to room temperature before analysis.
- Before analysis, adjust the pH to 7 with 5 N sodium hydroxide solution.
- Correct the test result for the dilution caused by the volume additions.

## Test procedure

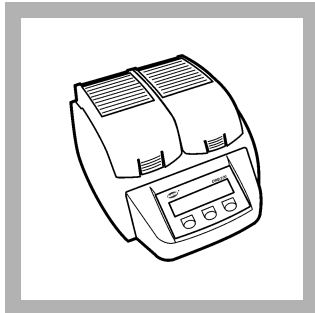

**1.** Set the DRB200 reactor power to on. Set the temperature to 100 °C.

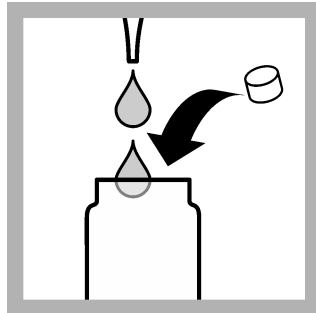

**2.** Add 1.3 mL of sample, 1.3 mL of Solution A and 1 Reagent B tablet in quick succession to a dry 20-mm reaction tube. Close the reaction tube immediately. Do not invert.

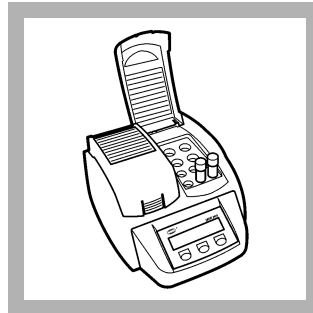

**3.** Insert the reaction tube in the preheated DRB200 reactor. Close the lid.



**4.** Keep the reaction tube in the reactor for 1 hour.

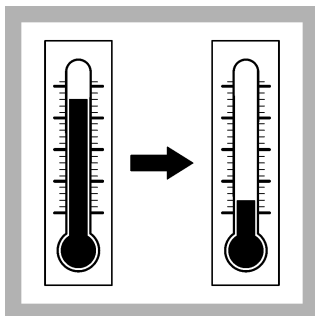

**5.** When the timer expires, carefully remove the reaction tube from the reactor. Let the temperature of the reaction tube decrease to room temperature.

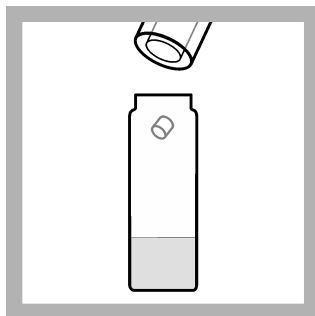

**6.** When cool, add 1 Micro Cap C to the reaction tube.

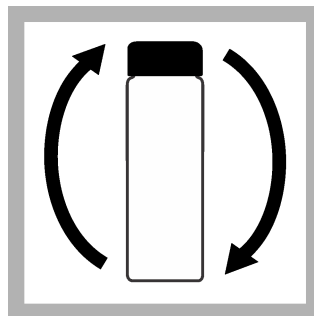

**7.** Tighten the cap on the reaction tube and invert until completely mixed.

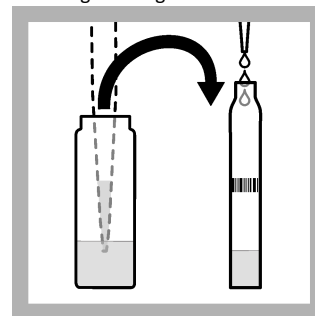

**8.** Use a pipet to add 0.5 mL of the digested sample from the 20-mm reaction tube into a test vial 1 (red label).



**9.** Use a pipet to add 0.2 mL of Solution D to the test vial.

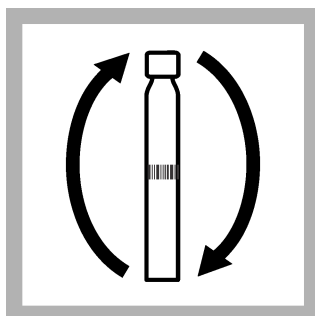

**10.** Quickly tighten the cap on the vial and invert until completely mixed. Immediately continue to the next step.

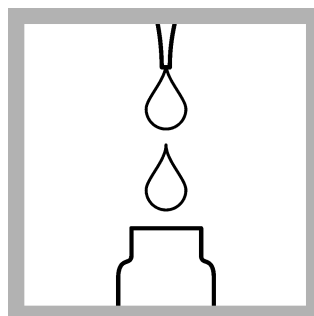

**11.** Use a pipet to add 1.0 mL of undigested sample to a test vial 2 (green label).

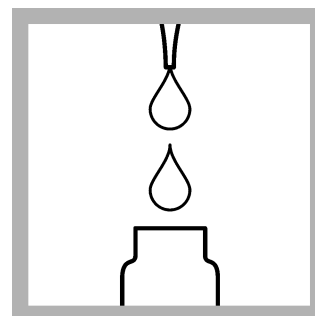

**12.** Use a pipet to add 0.2 mL of Solution D to the test vial.

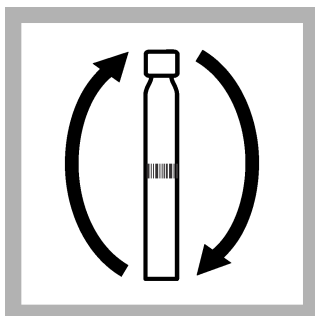

**13.** Quickly tighten the cap on the vial and invert until completely mixed.

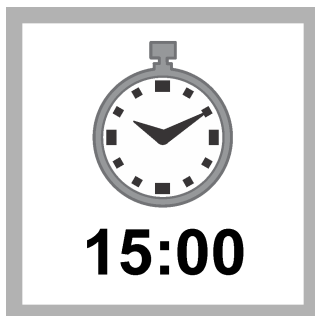

**14.** Start the reaction time of 15 minutes.

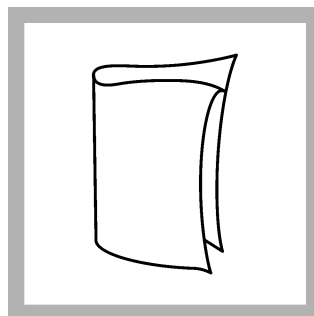

**15.** When the timer expires, clean the vials.

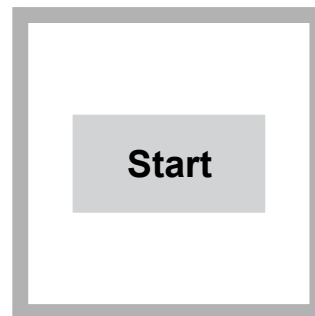

**16.** DR 1900 only: Select program 880. Refer to [Before starting](#) on page 1.

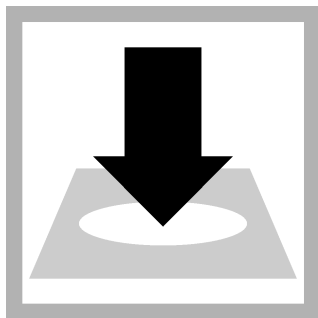
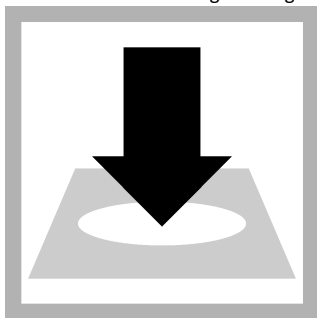

**17.** Insert the test vial 1 (red label) into the cell holder.

DR 1900 only: Push

**READ1.**

Immediately continue to the next step.

**18.** Insert the test vial 2 (green label) into the cell holder.

DR 1900 only: Push

**READ2.**

Results show in mg/L Total N, mg/L  $\text{NO}_3\text{-N}$  +  $\text{NO}_2\text{-N}$  and mg/L TKN.

## Interferences

High levels of oxidizable organic substances (COD) have an effect on the reagent color and give high results. Use this test procedure for wastewater only when the COD level is less than 500 mg/L COD.

Table 2 shows that the ions were individually examined to the given concentrations and do not cause interference. No cumulative effects or influences of other ions were found.

**Table 2 Non-interfering substances**

Interfering substance	Interference level
$\text{Cd}^{2+}$	50 mg/L
$\text{Ca}^{2+}$	50 mg/L
$\text{Cl}^-$	500 mg/L
$\text{Cr}^{6+}$	5 mg/L
$\text{Co}^{2+}$	10 mg/L
$\text{Cu}^{2+}$	50 mg/L
$\text{Fe}^{2+}$	10 mg/L
$\text{Fe}^{3+}$	50 mg/L
$\text{Pb}^{2+}$	50 mg/L
$\text{Ni}^{2+}$	50 mg/L
$\text{NO}_2^-$	2 mg/L
$\text{K}^+$	500 mg/L
$\text{Ag}^+$	100 mg/L
$\text{Na}^+$	500 mg/L
$\text{Sn}^{2+}$	50 mg/L
$\text{Zn}^{2+}$	50 mg/L

## Accuracy check

### Standard solution method

Use the standard solution method to validate the test procedure, the reagents and the instrument.

## Items to collect:

- Wastewater Effluent Standard Solution, Mixed Parameter (expected result: 7.56-mg/L Total N, 4-mg/L  $\text{NO}_3^-$ -N +  $\text{NO}_2^-$ -N, 3.56-mg/L TKN)
  - Use the test procedure to measure the concentration of the standard solution.
  - Compare the expected result to the actual result. The Wastewater Effluent Standard Solution contains a component that adds 1.56-mg/L N to the Total N and TKN values. This is in addition to the 2-mg/L  $\text{NH}_3$ -N and 4-mg/L  $\text{NO}_3^-$ -N shown on the label.

**Note:** The factory calibration can be adjusted slightly with the standard adjust option so that the instrument shows the expected value of the standard solution. The adjusted calibration is then used for all test results. This adjustment can increase the test accuracy when there are small variations in the reagents or instruments.

## Summary of Method

Total Kjeldahl Nitrogen (TKN) is the sum of organic nitrogen and ammonia. In the simplified TKN method, inorganic and organic nitrogen are oxidized to nitrate by digestion with peroxodisulfate. The nitrate ions react with 2,6-dimethylphenol in a solution of sulfuric and phosphoric acid to form a nitrophenol. Oxidized forms of nitrogen in the original sample (nitrite + nitrate due to sample preservation) are determined in the second test vial and then subtracted, which results in TKN.

## Consumables and replacement items

### Required reagents

Description	Quantity/Test	Unit	Item no.
Simplified TKN (s-TKN) TNTplus reagent set	1	25/pkg	TNT880

### Required apparatus

Description	Quantity/test	Unit	Item no.
DRB 200 Reactor, 115 VAC option, 9 x 13 mm + 2 x 20 mm, 1 block	1	each	DRB200-01
DRB 200 Reactor, 230 VAC option, 9 x 13 mm + 2 x 20 mm, 1 block	1	each	DRB200-05
Pipet, adjustable volume, 1.0–5.0 mL	1	each	BBP065
Pipet tips, for 1.0–5.0 mL pipet	1	75/pkg	BBP068
Pipet, adjustable volume, 0.2–1.0 mL	1	each	BBP078
Pipet tips, for 0.2–1.0 mL pipet	2	100/pkg	BBP079
Test tube rack	1	each	1864100
Light shield, DR 3800, DR 2800, DR 2700	1	each	LZV646
Light shield, DR 3900	1	each	LZV849

### Recommended standards

Description	Unit	Item no.
Wastewater Effluent Standard Solution, Mixed Parameter, for $\text{NH}_3$ -N, $\text{NO}_3^-$ -N, $\text{PO}_4^{3-}$ , COD, $\text{SO}_4^{2-}$ , TOC	500 mL	2833249

### Optional reagents and apparatus

Description	Unit	Item no.
Filter membrane, 0.45-micron, 25-mm	100/pkg	2514101
Filter holder, 25-mm, for Luer-type syringe	each	246800



**Optional reagents and apparatus (continued)**

Description	Unit	Item no.
Sampling bottle with cap, low density polyethylene, 500-mL	12/pkg	2087079
Sodium Hydroxide Standard Solution, 5.0 N	1 L	245053
Sulfuric Acid, concentrated, ACS	500 mL	97949
Syringe, 10-cc, Luer-Lock tip	each	2202400



**FOR TECHNICAL ASSISTANCE, PRICE INFORMATION AND ORDERING:**  
 In the U.S.A. – Call toll-free 800-227-4224  
 Outside the U.S.A. – Contact the HACH office or distributor serving you.  
 On the Worldwide Web – [www.hach.com](http://www.hach.com); E-mail – [techhelp@hach.com](mailto:techhelp@hach.com)

**HACH COMPANY**  
 WORLD HEADQUARTERS  
 Telephone: (970) 669-3050  
 FAX: (970) 669-2932



## Simplified TKN (s-TKN™): TKN Finally Made Easy!



<https://www.hach.com/SimplifiedTKN>

TKN (Total Kjeldahl Nitrogen) is the total concentration of organic nitrogen and ammonia. The original TKN method was developed by the Danish chemist Johan Kjeldahl in 1883. Today, TKN is a required parameter for regulatory reporting at many plants but is also used to provide a means of monitoring plant operations.

The traditional TKN method consists of digesting the sample at high temperatures for several hours with strong sulfuric acid and metal catalysts such as copper or mercury. Ultimately, the organic nitrogen is converted to ammonia for determination by a variety of analytical techniques. The analysis requires expensive, fragile equipment along with a large amount of laboratory space. In addition to the above limitations, the TKN method suffers from interferences that are not well understood and traditional methodologies have been unable to correct for these.

TKN comprises one of the most challenging, dangerous, and labor-intensive tests that a wastewater operator performs. Regardless of your method of testing, do-it-yourself or outsourcing, related waste disposal and cost per test present substantial expense. [Hach's s-TKN method](#) can help ease these headaches for under \$5 per test.

### Nitrogen Relationships

Total Nitrogen is defined as the sum of organic nitrogen, nitrate, nitrite, and ammonia:

$$\text{Total N} = \text{Organic N} + \text{NO}_3^- \text{-N} + \text{NO}_2^- \text{-N} + \text{NH}_3 \text{-N}$$

N = Nitrogen

$\text{NO}_3^- \text{-N}$  = Nitrate nitrogen,

$\text{NO}_2^- \text{-N}$  = Nitrite nitrogen, and

$\text{NH}_3 \text{-N}$  = Ammonia nitrogen

By definition, TKN, a component of total nitrogen, is the sum of organic nitrogen and ammonia. Therefore, the above equation may be re-written as:

$$\text{Total N} = \text{TKN} + \text{NO}_3^- \text{-N} + \text{NO}_2^- \text{-N}$$

### The Hach s-TKN Method

The s-TKN method is based on the above nitrogen relationship. By rearrangement, s-TKN is defined as the difference between the concentrations of total nitrogen and oxidized nitrogen:

$$\text{s-TKN} = \text{Total N} - (\text{NO}_3^- \text{-N} + \text{NO}_2^- \text{-N})$$

In the s-TKN method, total nitrogen is determined by a persulfate digestion in an enclosed vial, oxidizing all nitrogen forms to nitrate. The nitrate reacts with an indicator, forming a complex that is measured photometrically. An undigested sample aliquot reacts with an indicator to determine the oxidized nitrogen photometrically. The spectrophotometer automatically subtracts this value from the total nitrogen value and displays TKN, total nitrogen, and nitrate + nitrite.

### Benefits of the s-TKN Method

Simplified TKN contains everything needed to measure TKN in one box. The s-TKN Method uses TNTplus™ technology, offering safer pre-measured chemistries that work exclusively with the Hach DR Family of Spectrophotometers (DR 2800™, DR 3800™, DR 3900™, DR 5000™, and DR 6000™). The chemistry vials require no preparation or glassware (no cleanup!) and enable the spectrophotometer to automatically recognize the testing method, eliminating the need to pre-program or calibrate curves. No blank is required, further reducing expense. The new s-TKN system:

- Eliminates the use of hazardous mercury
- Reduces operating expenses with costs under \$5 per test—this represents an annual savings of over \$550 compared to outsourcing TKN on a monthly basis
- Minimizes training and equipment requirements
- Takes ~ 1 hour total analysis time with minimal hands-on time

### Real-time, effective process control

Performing a low-cost, safer TKN gives operators an improved tool for process control. Real-time results also eliminate the delay of outsourcing, giving a more effective tool for making necessary process adjustments. Additionally, with a nominal cost per test, the possibility of increased testing gives more optimal results.

**Dimethylphenol Method****Method 10206<sup>1</sup>****0.23 to 13.50 mg/L NO<sub>3</sub><sup>-</sup>-N or 1.00 to 60.00 mg/L NO<sub>3</sub><sup>-</sup> (LR)****TNTplus™ 835****Scope and application:** For wastewater, drinking water, surface water and process water.<sup>1</sup> USEPA approved for water and wastewater analysis, 40 CFR part 136.**Test preparation****Instrument-specific information**

[Table 1](#) shows all of the instruments that have the program for this test. The table also shows the adapter and light shield requirements for the applicable instruments that can use TNTplus vials.

To use the table, select an instrument, then read across to find the applicable information for this test.

**Table 1 Instrument-specific information for TNTplus vials**

Instrument	Adapters	Light shield
DR 6000, DR 5000	—	—
DR 3900	—	LZV849
DR 3800, DR 2800	—	LZV646
DR 1900	9609900 or 9609800 (A)	—

**Before starting**

DR 3900, DR 3800, DR 2800: Install the light shield in Cell Compartment #2 before this test is started.

Review the safety information and the expiration date on the package.

The recommended sample pH is 3–10.

The sample temperature must be 20–23 °C (68–73 °F) for accurate results.

The recommended temperature for reagent storage is 15–25 °C (59–77 °F).

DR 1900: Go to All Programs>LCK or TNTplus Methods>Options to select the TNTplus number for the test. Other instruments automatically select the method from the barcode on the vial.

Review the Safety Data Sheets (MSDS/SDS) for the chemicals that are used. Use the recommended personal protective equipment.

Dispose of reacted solutions according to local, state and federal regulations. Refer to the Safety Data Sheets for disposal information for unused reagents. Refer to the environmental, health and safety staff for your facility and/or local regulatory agencies for further disposal information.

**Items to collect**

Description	Quantity
Nitrate LR TNTplus Reagent Set	1
Pipet, adjustable volume, 0.2–1.0 mL	1
Pipet tips, for 0.2–1.0 mL pipet	1

Refer to [Consumables and replacement items](#) on page 4 for order information.

## Sample collection and storage

- Collect samples in clean glass or plastic bottles.
- Analyze the samples as soon as possible for best results.
- If immediate analysis is not possible, immediately filter and keep the samples at or below 6 °C (43 °F) for a maximum of 48 hours.
- To preserve samples for a maximum of 14 days, adjust the sample pH to 2 or less with concentrated sulfuric acid (approximately 2 mL per liter) and keep at or below 6 °C (43 °F). The test results then include nitrate and nitrite.
- Let the sample temperature increase to room temperature before analysis.
- Before analysis, adjust the pH to 7 with 5 N sodium hydroxide solution.
- Correct the test result for the dilution caused by the volume additions.

## Test procedure

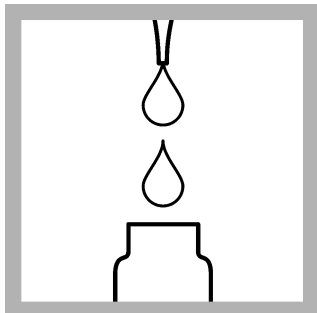

1. Use a pipet to add 1.0 mL of sample to the test vial.

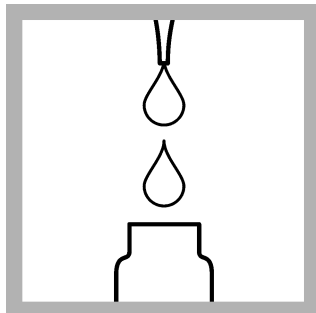

2. Use a pipet to add 0.2 mL of Solution A to the test vial.

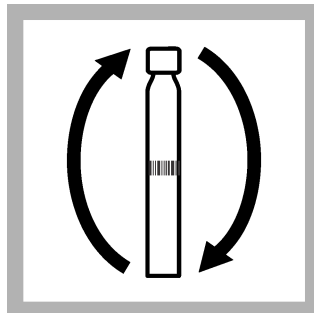

3. Tighten the cap on the vial and invert until completely mixed.



4. Start the reaction time of 15 minutes.

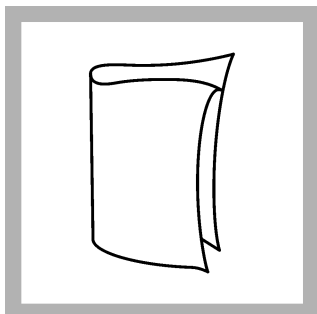

5. When the timer expires, clean the vial.

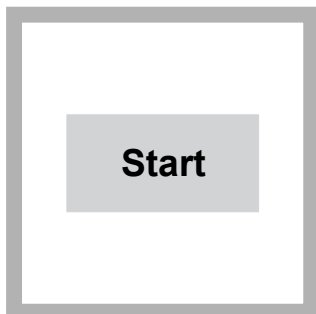

6. DR 1900 only: Select program 835. Refer to [Before starting](#) on page 1.

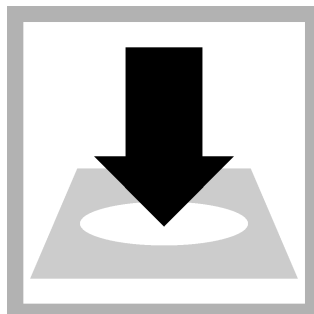

7. Insert the vial into the cell holder. DR 1900 only: Push **READ**. Results show in mg/L  $\text{NO}_3^-$ -N.

## Reagent blank correction

For the best results, measure the reagent blank value for each new lot of reagent. Replace the sample with deionized water in the test procedure to determine the reagent blank value. Subtract the reagent blank value from the sample results automatically with the reagent blank adjust option. Measure the reagent blank value when a new lot of reagent is used.

1. Use deionized water as the sample in the test procedure to measure the reagent blank value.
2. Set the reagent blank function to on. The measured reagent blank value is shown.

3. Accept the blank value. The reagent blank value is then subtracted from all results until the reagent blank function is set to off or a different method is selected.

**Note:** As an alternative, record or enter the reagent blank value at a different time. Push the highlighted reagent blank box and use the keypad to enter the value.

## Sample blanks

If the sample has color or turbidity, measure a sample blank to correct the test result for the interference.

### Items to collect:

- TNTplus 919 sample blank vial
1. Do the test procedure.
  2. Put the sample in the sample blank vial. Fill to the neck of the sample blank vial.
  3. Wipe the sample blank vial clean, then put it into the cell holder. If applicable, the instrument reads the barcode of the sample blank vial and subtracts the value from the initial test result.

## Interferences

Table 2 shows that the ions were individually examined to the given concentrations and do not cause interference. No cumulative effects or influences of other ions were found.

The cumulative effects and influence of other ions have not been found. High loads of oxidizable organic substances (COD) cause the reagent to change color and to give high-bias results. The test can thus only be used for wastewater analyses if the COD is less than 500 mg/L. Verify measurement results with sample dilutions or standard additions.

Nitrite concentrations of more than 2.0 mg/L interfere (high-bias results). Add 50 mg of sulfamic acid (amidosulfonic acid) to 5.0 mL of sample, dissolve and wait for 10 minutes. Analyze the prepared sample as described in the procedure above.

**Table 2 Interfering substances**

Interfering substance	Interference level
Cl <sup>-</sup>	500 mg/L
K <sup>+</sup>	500 mg/L
Na <sup>+</sup>	500 mg/L
Ca <sup>2+</sup>	50 mg/L
Cd <sup>2+</sup>	50 mg/L
Cu <sup>2+</sup>	50 mg/L
Fe <sup>3+</sup>	50 mg/L
Ni <sup>2+</sup>	50 mg/L
Pb <sup>2+</sup>	50 mg/L
Sn <sup>2+</sup>	50 mg/L
Zn <sup>2+</sup>	50 mg/L
Cr <sup>6+</sup>	5 mg/L
NO <sub>2</sub> <sup>-</sup>	2 mg/L
Ag <sup>+</sup>	100 mg/L
Co <sup>2+</sup>	10 mg/L
Fe <sup>2+</sup>	10 mg/L

## Accuracy check

### Standard solution method

Use the standard solution method to validate the test procedure, the reagents and the instrument.

Items to collect:

- Nitrate-Nitrogen Standard Solution, 10.0-mg/L  $\text{NO}_3^-$ -N or Wastewater Influent Standard Solution, Mixed Parameter

1. Use the test procedure to measure the concentration of the standard solution.
2. Compare the expected result to the actual result.

**Note:** The factory calibration can be adjusted slightly with the standard adjust option so that the instrument shows the expected value of the standard solution. The adjusted calibration is then used for all test results. This adjustment can increase the test accuracy when there are small variations in the reagents or instruments.

### Summary of Method

Nitrate ions in solutions that contain sulfuric and phosphoric acids react with 2,6-dimethylphenol to form 4-nitro-2,6-dimethylphenol. The measurement wavelength is 345 nm.

### Consumables and replacement items

#### Required reagents

Description	Quantity/Test	Unit	Item no.
Nitrate LR TNTplus Reagent Set	1	25/pkg	TNT835

#### Required apparatus

Description	Quantity/test	Unit	Item no.
Pipet, adjustable volume, 0.2–1.0 mL	1	each	BBP078
Pipet tips, for 0.2–1.0 mL pipet	2	100/pkg	BBP079
Light shield, DR 3800, DR 2800, DR 2700	1	each	LZV646
Light shield, DR 3900	1	each	LZV849

#### Recommended standards

Description	Unit	Item no.
Nitrate Nitrogen Standard Solution, 10.0-mg/L $\text{NO}_3^-$ -N	500 mL	30749
Nitrate Nitrogen Standard Solution 1000-mg/L $\text{NO}_3^-$ -N	500 mL	1279249
Wastewater Influent Standard Solution, Mixed Parameter, for $\text{NH}_3$ -N, $\text{NO}_3^-$ -N, $\text{PO}_4$ , COD, $\text{SO}_4$ , TOC	500 mL	2833149

#### Optional reagents and apparatus

Description	Unit	Item no.
Filter membrane, 0.45-micron, 25-mm	100/pkg	2514101
Sampling bottle with cap, low density polyethylene, 500-mL	12/pkg	2087079
Sodium Hydroxide Standard Solution, 5.0 N	100 mL MDB	245032
Sulfamic Acid, 454 g	each	234401
Sulfuric Acid, concentrated, ACS	500 mL	97949

**Optional reagents and apparatus (continued)**

Description	Unit	Item no.
Test tube rack, polyethylene, for 13-mm OD vials, 90 holes	each	2497900
Water, deionized	4 L	27256



**FOR TECHNICAL ASSISTANCE, PRICE INFORMATION AND ORDERING:**  
In the U.S.A. – Call toll-free **800-227-4224**  
Outside the U.S.A. – Contact the **HACH office or distributor serving you.**  
On the Worldwide Web – **www.hach.com**; E-mail – **techhelp@hach.com**

**HACH COMPANY**  
WORLD HEADQUARTERS  
Telephone: (970) 669-3050  
FAX: (970) 669-2932



**Dimethylphenol Method****Method 10206<sup>1</sup>****5 to 35 mg/L NO<sub>3</sub><sup>-</sup>-N or 22 to 155 mg/L NO<sub>3</sub><sup>-</sup> (HR)****TNTplus™ 836****Scope and application:** For wastewater, drinking water, surface water and process water.<sup>1</sup> USEPA approved for water and wastewater analysis, 40 CFR part 136.**Test preparation****Instrument-specific information**

[Table 1](#) shows all of the instruments that have the program for this test. The table also shows the adapter and light shield requirements for the applicable instruments that can use TNTplus vials.

To use the table, select an instrument, then read across to find the applicable information for this test.

**Table 1 Instrument-specific information for TNTplus vials**

Instrument	Adapters	Light shield
DR 6000, DR 5000	—	—
DR 3900	—	LZV849
DR 3800, DR 2800	—	LZV646
DR 1900	9609900 or 9609800 (A)	—

**Before starting**

DR 3900, DR 3800, DR 2800: Install the light shield in Cell Compartment #2 before this test is started.

Review the safety information and the expiration date on the package.

The recommended sample pH is 3–10.

The sample temperature must be 20–23 °C (68–73 °F) for accurate results.

The recommended temperature for reagent storage is 15–25 °C (59–77 °F).

DR 1900: Go to All Programs>LCK or TNTplus Methods>Options to select the TNTplus number for the test. Other instruments automatically select the method from the barcode on the vial.

Review the Safety Data Sheets (MSDS/SDS) for the chemicals that are used. Use the recommended personal protective equipment.

Dispose of reacted solutions according to local, state and federal regulations. Refer to the Safety Data Sheets for disposal information for unused reagents. Refer to the environmental, health and safety staff for your facility and/or local regulatory agencies for further disposal information.

**Items to collect**

Description	Quantity
Nitrate HR TNTplus Reagent Set	1
Pipet, adjustable volume, 0.2–1.0 mL	1
Pipet tips, for 0.2–1.0 mL pipet	1

Refer to [Consumables and replacement items](#) on page 4 for order information.

## Sample collection and storage

- Collect samples in clean glass or plastic bottles.
- Analyze the samples as soon as possible for best results.
- If immediate analysis is not possible, immediately filter and keep the samples at or below 6 °C (43 °F) for a maximum of 48 hours.
- To preserve samples for a maximum of 14 days, adjust the sample pH to 2 or less with concentrated sulfuric acid (approximately 2 mL per liter) and keep at or below 6 °C (43 °F). The test results then include nitrate and nitrite.
- Let the sample temperature increase to room temperature before analysis.
- Before analysis, adjust the pH to 7 with 5 N sodium hydroxide solution.
- Correct the test result for the dilution caused by the volume additions.

## Test procedure

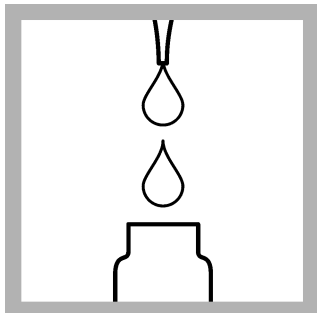

1. Use a pipet to add 0.2 mL of sample to the test vial.

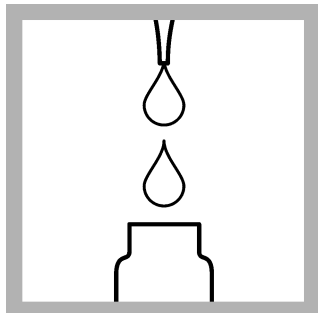

2. Use a pipet to add 1.0 mL of Solution A to the test vial.

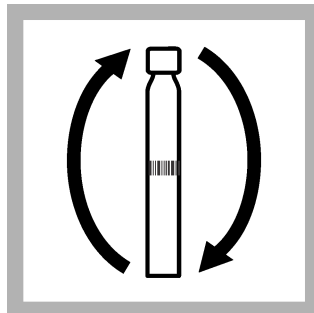

3. Tighten the cap on the vial and invert until completely mixed.



4. Start the reaction time of 15 minutes.

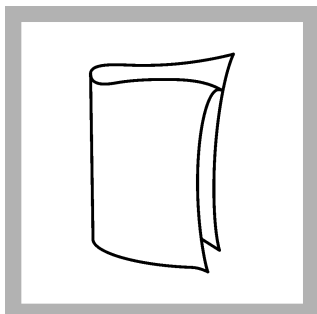

5. When the timer expires, clean the vial.



6. DR 1900 only: Select program 836. Refer to [Before starting](#) on page 1.

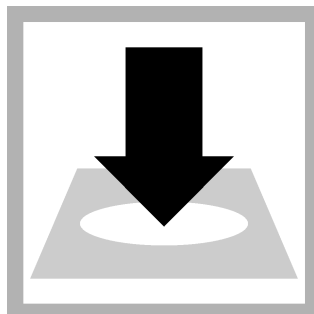

7. Insert the vial into the cell holder. DR 1900 only: Push **READ**. Results show in mg/L  $\text{NO}_3^-$ -N.

## Reagent blank correction

For the best results, measure the reagent blank value for each new lot of reagent. Replace the sample with deionized water in the test procedure to determine the reagent blank value. Subtract the reagent blank value from the sample results automatically with the reagent blank adjust option. Measure the reagent blank value when a new lot of reagent is used.

1. Use deionized water as the sample in the test procedure to measure the reagent blank value.
2. Set the reagent blank function to on. The measured reagent blank value is shown.

3. Accept the blank value. The reagent blank value is then subtracted from all results until the reagent blank function is set to off or a different method is selected.

**Note:** As an alternative, record or enter the reagent blank value at a different time. Push the highlighted reagent blank box and use the keypad to enter the value.

## Sample blanks

If the sample has color or turbidity, measure a sample blank to correct the test result for the interference.

### Items to collect:

- TNTplus 919 sample blank vial
1. Do the test procedure.
  2. Put the sample in the sample blank vial. Fill to the neck of the sample blank vial.
  3. Wipe the sample blank vial clean, then put it into the cell holder. If applicable, the instrument reads the barcode of the sample blank vial and subtracts the value from the initial test result.

## Interferences

Table 2 shows that the ions and levels were individually examined to the given concentrations and do not cause interference. The cumulative effects and influence of other ions have not been found. High loads of oxidizable organic substances (COD) cause the reagent to change color and to give high-bias results. The test can thus only be used for wastewater analyses if the COD is less than 500 mg/L. Measurement results can be verified with sample dilutions or standard additions.

Nitrite concentrations of more than 2.0 mg/L interfere (high-bias results). Add 50 mg of sulfamic acid (amidosulfonic acid) to 5.0 mL of sample, dissolve and wait for 10 minutes. Analyze the prepared sample as described in the procedure above.

**Table 2 Interfering substances**

Interference level	Interference level
K <sup>+</sup>	2000 mg/L
Na <sup>+</sup>	1500 mg/L
Cl <sup>-</sup>	1000 mg/L
COD	500 mg/L
Ca <sup>2+</sup>	250 mg/L
Ag <sup>+</sup>	100 mg/L
Pb <sup>2+</sup> , Zn <sup>2+</sup> , Ni <sup>2+</sup> , Fe <sup>3+</sup> , Cd <sup>2+</sup> , Cu <sup>2+</sup>	50 mg/L
Fe <sup>2+</sup>	20 mg/L
Co <sup>2+</sup>	10 mg/L
Cr <sup>6+</sup>	5 mg/L
NO <sub>2</sub> <sup>-</sup>	2 mg/L

## Accuracy check

### Standard solution method

Use the standard solution method to validate the test procedure, the reagents and the instrument.

Items to collect:

- Nitrate-Nitrogen Standard Solution, 10-mg/L NO<sub>3</sub><sup>-</sup>-N or Wastewater Influent Standard Solution, Mixed Parameter

1. Use the test procedure to measure the concentration of the standard solution.
2. Compare the expected result to the actual result.

*Note: The factory calibration can be adjusted slightly with the standard adjust option so that the instrument shows the expected value of the standard solution. The adjusted calibration is then used for all test results. This adjustment can increase the test accuracy when there are small variations in the reagents or instruments.*

## Summary of Method

Nitrate ions in solutions that contains sulfuric and phosphoric acids react with 2,6-dimethylphenol to form 4-nitro-2,6-dimethylphenol. The measurement wavelength is 345 nm.

## Consumables and replacement items

### Required reagents

Description	Quantity/Test	Unit	Item no.
Nitrate HR TNTplus Reagent Set	1	25/pkg	TNT836

### Required apparatus

Description	Quantity/test	Unit	Item no.
Pipet, adjustable volume, 0.2–1.0 mL	1	each	BBP078
Pipet tips, for 0.2–1.0 mL pipet	2	100/pkg	BBP079
Light shield, DR 3800, DR 2800, DR 2700	1	each	LZV646
Light shield, DR 3900	1	each	LZV849

### Recommended standards

Description	Unit	Item no.
Nitrate Nitrogen Standard Solution, 10.0-mg/L NO <sub>3</sub> -N	500 mL	30749
Nitrate Nitrogen Standard Solution 1000-mg/L NO <sub>3</sub> -N	500 mL	1279249
Wastewater Influent Standard Solution, Mixed Parameter, for NH <sub>3</sub> -N, NO <sub>3</sub> -N, PO <sub>4</sub> , COD, SO <sub>4</sub> , TOC	500 mL	2833149

### Optional reagents and apparatus

Description	Unit	Item no.
Filter membrane, 0.45-micron, 25-mm	100/pkg	2514101
Sampling bottle with cap, low density polyethylene, 500-mL	12/pkg	2087079
Sodium Hydroxide Standard Solution, 5.0 N	100 mL MDB	245032
Sulfamic Acid, 454 g	each	234401
Sulfuric Acid, concentrated, ACS	500 mL	97949
Test tube rack, polyethylene, for 13-mm OD vials, 90 holes	each	2497900
Water, deionized	4 L	27256



FOR TECHNICAL ASSISTANCE, PRICE INFORMATION AND ORDERING:  
 In the U.S.A. – Call toll-free 800-227-4224  
 Outside the U.S.A. – Contact the HACH office or distributor serving you.  
 On the Worldwide Web – [www.hach.com](http://www.hach.com); E-mail – [techhelp@hach.com](mailto:techhelp@hach.com)

HACH COMPANY  
 WORLD HEADQUARTERS  
 Telephone: (970) 669-3050  
 FAX: (970) 669-2932

**USEPA<sup>1</sup> Diazotization Method****Method 10207****0.015 to 0.600 mg/L NO<sub>2</sub><sup>-</sup>-N or 0.05 to 2.00 mg/L NO<sub>2</sub><sup>-</sup> (LR)****TNTplus™ 839****Scope and application:** For wastewater, drinking water, surface water and mineral water.<sup>1</sup> USEPA equivalent for wastewater analysis.**Test preparation****Instrument-specific information**

[Table 1](#) shows all of the instruments that have the program for this test. The table also shows the adapter and light shield requirements for the applicable instruments that can use TNTplus vials.

To use the table, select an instrument, then read across to find the applicable information for this test.

**Table 1 Instrument-specific information for TNTplus vials**

Instrument	Adapters	Light shield
DR 6000, DR 5000	—	—
DR 3900	—	LZV849
DR 3800, DR 2800	—	LZV646
DR 1900	9609900 or 9609800 (A)	—

**Before starting**

DR 3900, DR 3800, DR 2800: Install the light shield in Cell Compartment #2 before this test is started.

Review the safety information and the expiration date on the package.

The recommended sample pH is 3–10.

The recommended temperature for samples and reagents is 15–25 °C (59–77 °F).

The recommended temperature for reagent storage is 15–25 °C (59–77 °F).

DR 1900: Go to All Programs>LCK or TNTplus Methods>Options to select the TNTplus number for the test. Other instruments automatically select the method from the barcode on the vial.

Review the Safety Data Sheets (MSDS/SDS) for the chemicals that are used. Use the recommended personal protective equipment.

Dispose of reacted solutions according to local, state and federal regulations. Refer to the Safety Data Sheets for disposal information for unused reagents. Refer to the environmental, health and safety staff for your facility and/or local regulatory agencies for further disposal information.

**Items to collect**

Description	Quantity
Nitrite LR TNTplus Reagent Set	1
Pipet, adjustable volume, 1.0–5.0 mL	1
Pipet tips, for 1.0–5.0 mL pipet	1

Refer to [Consumables and replacement items](#) on page 4 for order information.

## Sample collection and storage

- Collect samples in clean glass or plastic bottles.
- To preserve samples for later analysis, keep the samples at or below 6 °C (43 °F) for up to 48 hours.
- Let the sample temperature increase to room temperature before analysis.

## Test procedure

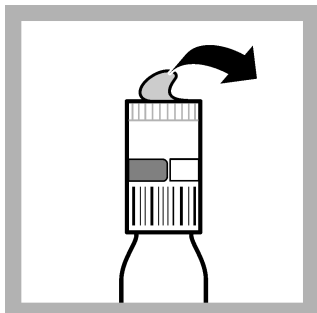

1. Carefully remove the lid from the DosiCap™ Zip cap. Remove the cap from the test vial.

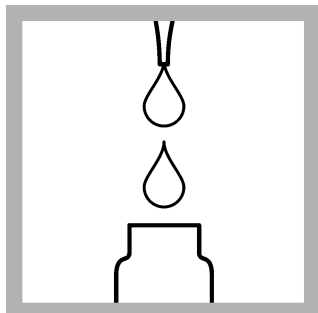

2. Use a pipet to add 2.0 mL of sample to the test vial. Immediately continue to the next step.

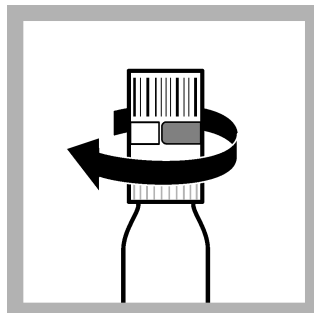

3. Turn the DosiCap Zip over so that the reagent side goes on the test vial. Tighten the cap on the vial.

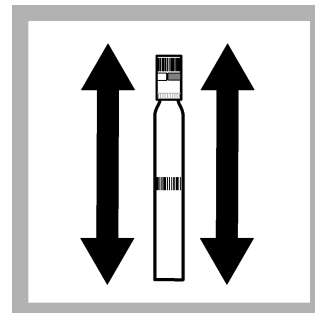

4. Shake the vial 2–3 times to dissolve the reagent in the cap. Look through the open end of the DosiCap to make sure that the reagent has dissolved.



5. Start the reaction time of 10 minutes.

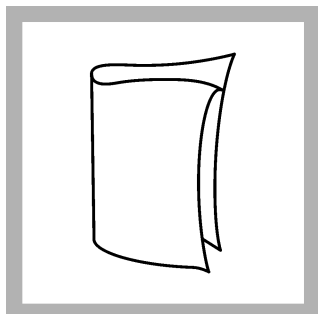

6. When the timer expires, clean the vial.

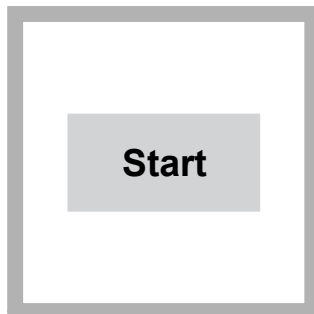

7. DR 1900 only: Select program 839. Refer to [Before starting](#) on page 1.

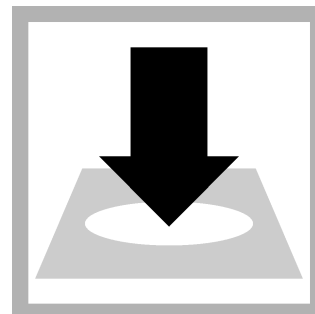

8. Insert the vial into the cell holder. DR 1900 only: Push **READ**. Results show in mg/L NO<sub>2</sub><sup>-</sup>-N.

## Reagent blank correction

For the best results, measure the reagent blank value for each new lot of reagent. Replace the sample with deionized water in the test procedure to determine the reagent blank value. Subtract the reagent blank value from the sample results automatically with the reagent blank adjust option. Measure the reagent blank value when a new lot of reagent is used.

1. Use deionized water as the sample in the test procedure to measure the reagent blank value.
2. Set the reagent blank function to on. The measured reagent blank value is shown.
3. Accept the blank value. The reagent blank value is then subtracted from all results until the reagent blank function is set to off or a different method is selected.

**Note:** As an alternative, record or enter the reagent blank value at a different time. Push the highlighted reagent blank box and use the keypad to enter the value.

## Sample blanks

If the sample has color or turbidity, measure a sample blank to correct the test result for the interference.

### Items to collect:

- TNTplus 919 sample blank vial
1. Do the test procedure.
  2. Put the sample in the sample blank vial. Fill to the neck of the sample blank vial.
  3. Wipe the sample blank vial clean, then put it into the cell holder. If applicable, the instrument reads the barcode of the sample blank vial and subtracts the value from the initial test result.

## Interferences

Table 2 shows that the ions were individually examined to the given concentrations and do not cause interference. No cumulative effects or influences of other ions were found.

**Table 2 Interfering substances**

Interfering substance	Interference level
Cl <sup>-</sup> , SO <sub>4</sub> <sup>2-</sup>	2000 mg/L
K <sup>+</sup> , NO <sub>3</sub> <sup>-</sup>	1000 mg/L
NH <sub>4</sub> <sup>+</sup> , PO <sub>4</sub> <sup>3-</sup> , Ca <sup>2+</sup>	500 mg/L
Mg <sup>2+</sup>	100 mg/L
Cr <sup>3+</sup>	50 mg/L
Co <sup>2+</sup> , Zn <sup>2+</sup> , Cd <sup>2+</sup> , Mn <sup>2+</sup> , Hg <sup>2+</sup>	25 mg/L
Ni <sup>2+</sup>	12 mg/L
Ag <sup>+</sup> , Fe <sup>2+</sup>	10 mg/L
Sn <sup>4+</sup> , Fe <sup>3+</sup>	5 mg/L
Cu <sup>2+</sup>	< 1 mg/L

## Accuracy check

### Standard solution method

Use the standard solution method to validate the test procedure, the reagents and the instrument.

Items to collect:

- 0.30-mg/L NO<sub>2</sub><sup>-</sup>-N Standard Solution<sup>1</sup>
1. Use the test procedure to measure the concentration of the standard solution.
  2. Compare the expected result to the actual result.

**Note:** The factory calibration can be adjusted slightly with the standard adjust option so that the instrument shows the expected value of the standard solution. The adjusted calibration is then used for all test results. This adjustment can increase the test accuracy when there are small variations in the reagents or instruments.

## Summary of Method

Nitrite in the sample reacts with a primary aromatic amine in acidic solution to form a diazonium salt. This salt combines with an aromatic compound to form a complex with color that is directly proportional to the amount of nitrite in the sample. The measurement wavelength is 515 nm.

<sup>1</sup> Nitrite standard solutions are difficult to prepare. Use the instructions in Standard Methods for the Examination of Water and Wastewater, Method 4500—NO<sub>2</sub>-B.

## Consumables and replacement items

### Required reagents

Description	Quantity/Test	Unit	Item no.
Nitrite LR TNTplus Reagent Set	1	25/pkg	TNT839

### Required apparatus

Description	Quantity/test	Unit	Item no.
Pipet, adjustable volume, 1.0–5.0 mL	1	each	BBP065
Pipet tips, for 1.0–5.0 mL pipet	1	75/pkg	BBP068
Light shield, DR 3800, DR 2800, DR 2700	1	each	LZV646
Light shield, DR 3900	1	each	LZV849

### Recommended standards

Description	Unit	Item no.
Sodium Nitrite, ACS	454 g	245201

### Optional reagents and apparatus

Description	Unit	Item no.
Sampling bottle with cap, low density polyethylene, 500-mL	12/pkg	2087079
Test tube rack, polyethylene, for 13-mm OD vials, 90 holes	each	2497900
Water, deionized	4 L	27256



FOR TECHNICAL ASSISTANCE, PRICE INFORMATION AND ORDERING:  
 In the U.S.A. – Call toll-free 800-227-4224  
 Outside the U.S.A. – Contact the HACH office or distributor serving you.  
 On the Worldwide Web – [www.hach.com](http://www.hach.com); E-mail – [techhelp@hach.com](mailto:techhelp@hach.com)

HACH COMPANY  
 WORLD HEADQUARTERS  
 Telephone: (970) 669-3050  
 FAX: (970) 669-2932



**Diazotization Method<sup>1</sup>****Method 10237****0.6 to 6.0 mg/L NO<sub>2</sub><sup>-</sup>-N or 2.0 to 20.0 mg/L NO<sub>2</sub><sup>-</sup> (HR)****TNTplus<sup>®</sup> 840****Scope and application:** For wastewater, drinking water, surface water and process water,<sup>1</sup> Adapted from Standard Methods for the Examination of Water and Wastewater.**Test preparation****Instrument-specific information**

[Table 1](#) shows all of the instruments that have the program for this test. The table also shows the adapter and light shield requirements for the applicable instruments that can use TNTplus vials.

To use the table, select an instrument, then read across to find the applicable information for this test.

**Table 1 Instrument-specific information for TNTplus vials**

Instrument	Adapters	Light shield
DR 6000, DR 5000	—	—
DR 3900	—	LZV849
DR 3800, DR 2800	—	LZV646
DR 1900	9609900 or 9609800 (A)	—

**Before starting**

DR 3900, DR 3800, DR 2800: Install the light shield in Cell Compartment #2 before this test is started.

Review the safety information and the expiration date on the package.

The recommended sample pH is 3–10.

The recommended temperature for samples and reagents is 15–25 °C (59–77 °F).

The recommended temperature for reagent storage is 15–25 °C (59–77 °F).

DR 1900: Go to All Programs>LCK or TNTplus Methods>Options to select the TNTplus number for the test. Other instruments automatically select the method from the barcode on the vial.

Review the Safety Data Sheets (MSDS/SDS) for the chemicals that are used. Use the recommended personal protective equipment.

Dispose of reacted solutions according to local, state and federal regulations. Refer to the Safety Data Sheets for disposal information for unused reagents. Refer to the environmental, health and safety staff for your facility and/or local regulatory agencies for further disposal information.

**Items to collect**

Description	Quantity
Nitrite HR TNTplus Reagent Set	1
Pipet, adjustable volume, 0.2–1.0 mL	1
Pipet tips, for 0.2–1.0 mL pipet	1

Refer to [Consumables and replacement items](#) on page 4 for order information.

## Sample collection and storage

- Collect samples in clean glass or plastic bottles.
- To preserve samples for later analysis, keep the samples at or below 6 °C (43 °F) for up to 48 hours.
- Let the sample temperature increase to room temperature before analysis.

## Test procedure

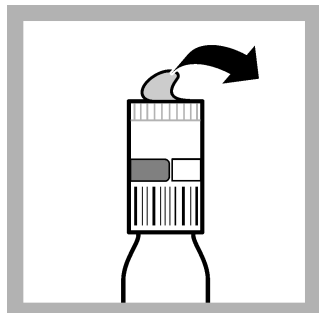

1. Carefully remove the lid from the DosiCap™ Zip cap. Remove the cap from the test vial.

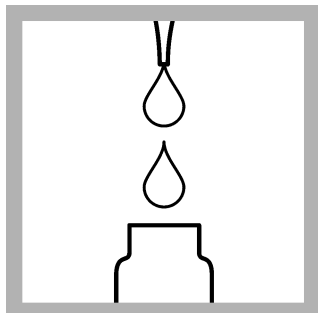

2. Use a pipet to add 0.2 mL of sample to the test vial. Immediately continue to the next step.

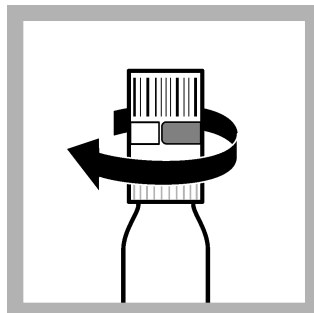

3. Turn the DosiCap Zip over so that the reagent side goes on the test vial. Tighten the cap on the vial.

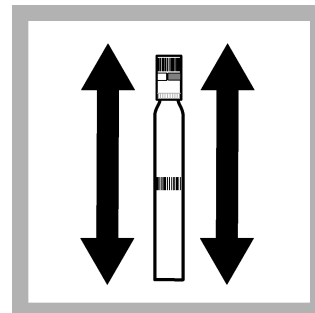

4. Shake the vial 2–3 times to dissolve the reagent in the cap. Look through the open end of the DosiCap to make sure that the reagent has dissolved.



5. Start the reaction time of 10 minutes.

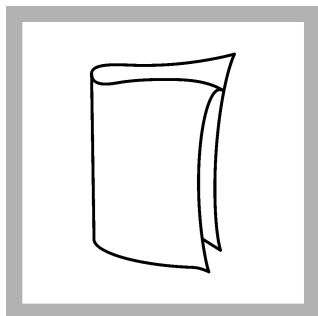

6. When the timer expires, clean the vial.

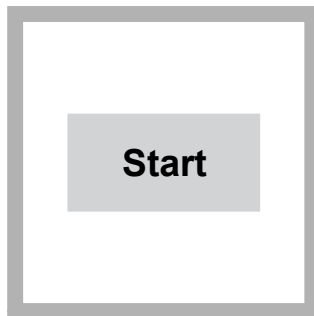

7. DR 1900 only: Select program 840. Refer to [Before starting](#) on page 1.

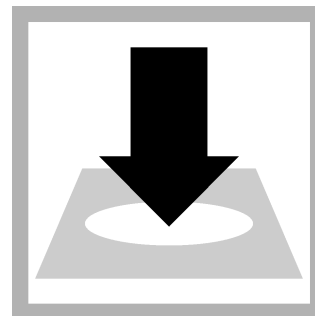

8. Insert the vial into the cell holder. DR 1900 only: Push **READ**. Results show in mg/L NO<sub>2</sub><sup>-</sup>-N.

## Reagent blank correction

For the best results, measure the reagent blank value for each new lot of reagent. Replace the sample with deionized water in the test procedure to determine the reagent blank value. Subtract the reagent blank value from the sample results automatically with the reagent blank adjust option. Measure the reagent blank value when a new lot of reagent is used.

1. Use deionized water as the sample in the test procedure to measure the reagent blank value.
2. Set the reagent blank function to on. The measured reagent blank value is shown.
3. Accept the blank value. The reagent blank value is then subtracted from all results until the reagent blank function is set to off or a different method is selected.

**Note:** As an alternative, record or enter the reagent blank value at a different time. Push the highlighted reagent blank box and use the keypad to enter the value.

## Sample blanks

Samples with color or turbidity can cause high results. Samples without color or turbidity do not require sample blanks. To adjust for color or turbidity, use the steps that follow to find the sample blank.

1. Do the test procedure, but do not remove the foil lid from the vial.
2. Put the cap on the vial.
3. Subtract the value from the final procedure step from the initial sample value to get the corrected sample concentration.

## Interferences

Table 2 that the ions were individually examined to the given concentrations and do not cause interference. No cumulative effects or influences of other ions were found.

Chromium (VI) ions interfere with the determination. Copper (II) ions interfere with the determination even at concentrations below 1 mg/L.

**Table 2 Interfering substances**

Interfering substance	Interference level
Sn <sup>4+</sup>	10 mg/L
Fe <sup>2+</sup> , Fe <sup>3+</sup> , Ni <sup>2+</sup> , Ag <sup>+</sup>	20 mg/L
Co <sup>2+</sup> , Zn <sup>2+</sup> , Cd <sup>2+</sup> , Mn <sup>2+</sup>	50 mg/L
Cr <sup>3+</sup> , Hg <sup>2+</sup>	100 mg/L
Mg <sup>2+</sup>	200 mg/L
NH <sub>4</sub> <sup>+</sup> , PO <sub>4</sub> <sup>3-</sup>	1000 mg/L
K <sup>+</sup> , NO <sub>3</sub> <sup>-</sup> , Ca <sup>2+</sup> , Cl <sup>-</sup>	2000 mg/L
SO <sub>4</sub> <sup>2-</sup>	4000 mg/L

## Accuracy check

### Standard solution method

Use the standard solution method to validate the test procedure, the reagents and the instrument.

Items to collect:

- 3.0-mg/L NO<sub>2</sub><sup>-</sup>-N Standard Solution<sup>1</sup>

1. Use the test procedure to measure the concentration of the standard solution.
2. Compare the expected result to the actual result.

**Note:** The factory calibration can be adjusted slightly with the standard adjust option so that the instrument shows the expected value of the standard solution. The adjusted calibration is then used for all test results. This adjustment can increase the test accuracy when there are small variations in the reagents or instruments.

## Method performance

The method performance data that follows was derived from laboratory tests that were measured on a spectrophotometer during ideal test conditions. Users can get different results under different test conditions.

Program	Standard	Precision (95% confidence interval)	Sensitivity Concentration change per 0.010 Abs change
barcode	3.0 mg/L NO <sub>2</sub> <sup>-</sup> -N	2.94–3.06 mg/L NO <sub>2</sub> <sup>-</sup> -N	0.05 mg/L NO <sub>2</sub> <sup>-</sup> -N

<sup>1</sup> Nitrite standard solutions are difficult to prepare. Use the instructions in Standard Methods for the Examination of Water and Wastewater, Method 4500—NO<sub>2</sub><sup>-</sup>-B.

## Summary of Method

Nitrite in the sample reacts with a primary aromatic amine in acidic solution to form a diazonium salt. This couples with an aromatic compound to form a complex with color that is directly proportional to the amount of nitrite in the sample. The measurement wavelength is 515 nm.

## Consumables and replacement items

### Required reagents

Description	Quantity/Test	Unit	Item no.
Nitrite HR TNTplus Reagent Set	1	25/pkg	TNT840

### Required apparatus

Description	Quantity/test	Unit	Item no.
Pipet, adjustable volume, 0.2–1.0 mL	1	each	BBP078
Pipet tips, for 0.2–1.0 mL pipet	2	100/pkg	BBP079
Light shield, DR 3800, DR 2800, DR 2700	1	each	LZV646
Light shield, DR 3900	1	each	LZV849

### Recommended standards

Description	Unit	Item no.
Sodium Nitrite, ACS	454 g	245201

### Optional reagents and apparatus

Description	Unit	Item no.
Sampling bottle with cap, low density polyethylene, 500-mL	12/pkg	2087079
Test tube rack, polyethylene, for 13-mm OD vials, 90 holes	each	2497900
Water, deionized	4 L	27256



FOR TECHNICAL ASSISTANCE, PRICE INFORMATION AND ORDERING:  
 In the U.S.A. – Call toll-free 800-227-4224  
 Outside the U.S.A. – Contact the HACH office or distributor serving you.  
 On the Worldwide Web – [www.hach.com](http://www.hach.com); E-mail – [techhelp@hach.com](mailto:techhelp@hach.com)

HACH COMPANY  
 WORLD HEADQUARTERS  
 Telephone: (970) 669-3050  
 FAX: (970) 669-2932

# The Facts about Nutrient Pollution

Nutrient (aka nitrogen and phosphorus) pollution is one of America's most widespread, costly and challenging environmental problems. It is caused by excess nitrogen and phosphorus in the air and water. Nutrients are chemical elements that all living organisms—plants and animals—need to grow. When too much nitrogen and phosphorus enter the environment—usually from a wide range of human activities—the air and water can become polluted.

## Sources of Nutrient Pollution

The primary sources of nutrient pollution are fertilizer, animal manure, sewage treatment plant discharge, detergents, stormwater runoff, cars and power plants, failing septic tanks and pet waste. In the Mississippi River Basin, which spans 31 states and ultimately drains into the Gulf of Mexico, nutrients from row crops, large farms and concentrated animal feeding operations contribute the most nutrient pollution.

## Effects of Nutrient Pollution

Excessive nitrogen and phosphorus in water and the air can cause health problems, damage our land and water, and take a heavy toll on the economy.

### Human Health

Nutrients can lead to a massive overgrowth of algae, known as an algae bloom. Certain types of algae emit toxins that are absorbed by shellfish; consuming these tainted shellfish can lead to stomach illness and short-term memory problems. Drinking or coming into contact with toxins from algae blooms can cause stomach aches, rashes and more serious problems. Excess nitrogen is a common drinking water contaminant in agricultural areas and can pose particular risk to infants younger than six months old. Chemicals used to treat nutrient-polluted drinking water can pose additional risks to human health. These chemicals, including chlorine, can react with the algae in the water to form disinfection by-products that have been associated with reproductive and developmental health problems. Nitrogen pollutants in the air from burning fossil fuels can contribute to a variety of respiratory problems for children, the elderly and those with lung ailments.

### The Environment

Nutrient pollution damages the environment and harms water quality. Algal blooms consume large amounts of oxygen that fish, shellfish and other organisms need to survive. Algal blooms can make water cloudy, reduce the ability of aquatic life to find food, and clog the gills of fish. Some algal blooms produce toxins that can cause illnesses or death for animals like turtles, seabirds, dolphins, fish and shellfish.

### Nutrient Pollution: The Numbers

- 15,000** Estimated number of water bodies in the United States impaired\* by nutrients
- 101,000** Miles of rivers and streams impaired\* by nutrients in the United States\*\*
- 3,500,000** Acres of lakes and reservoirs impaired\* by nutrients in the United States\*\*
- 78%** Percentage of the continental U.S. coastal waters that exhibit an overgrowth of algae\*
- > 20%** Percentage of shallow household wells in agricultural areas with nitrate levels above drinking water standards. More than 90% of people living in Mississippi get their drinking water from ground water.
- 60%** Percentage of Americans whose actions or food choices consume (directly or indirectly) freshwater from the Mississippi River Basin

\*Waters that do not meet one or more basic uses like swimming or fishing

\*\*Based on state Clean Water Act 305 (b) reports available in EPA's Assessment and Total Maximum Daily Load Tracking and Implementation System (<http://www.epa.gov/waters/ir>) as of March 14, 2012.



Photo credit: U.S. Geological Survey, Binder Lake, Iowa.

Nutrient pollution causes green slime that affects drinking water, recreation, businesses and property values. In Tennessee alone, nutrients impair nearly 3,000 river/stream miles and more than 15,000 acres of lakes and reservoirs.



Airborne nitrogen can also pose environmental risks. Nitrogen compounds released into the air by burning fossil fuels can react with water, oxygen and other chemicals to form nitric acid. When it falls to earth, the *acid rain* can damage an entire ecosystem, including streams, estuaries, forests and grasslands. Airborne compounds like nitrogen oxides contribute to the formation of other air pollutants, such as ozone—a component of smog—which can restrict visibility. Wind and weather can carry ozone many miles from urban to rural areas, where it can damage trees.

## The Economy

Nutrient pollution has diverse and far-reaching effects on the U.S. economy, impacting many sectors that depend on clean water. The tourism industry loses close to \$1 billion each year, mostly from losses in fishing and boating activities because of nutrient-polluted water bodies. In Mississippi alone, tourism in the three counties that border the Gulf Coast accounts for about \$1.6 billion in visitor expenditures, 32 percent of state travel and tourism tax revenues, and 24,000 direct jobs.

Nutrient pollution causes annual losses to the commercial fishing and shellfish industry in the tens of millions of dollars. When oxygen levels are low, fishery yields are reduced. During harmful algal blooms, consumers become wary that seafood could be tainted by toxins. Algal blooms can also negatively impact waterfront property values. Algal blooms in drinking water sources can drastically increase treatment costs and subsequently increase consumer utility bills. Costs to clean up polluted water bodies, such as the Chesapeake Bay, can cost billions of dollars. Airborne nutrient pollution can also affect visibility at outdoor tourist destinations, like national parks. Airborne nitrogen compounds can damage structures, especially ones made of marble and limestone.



Photo credit: Bill Yates, St. John's River, Florida

### Impacts on Drinking Water and the Economy

Algal blooms in drinking water sources can increase treatment costs and consumer utility bills.

## How Are We Addressing Nutrient Pollution?

EPA is working with its many partners to address nutrient pollution across the country. EPA

- ▶ Provides technical guidance and resources to help states develop water quality criteria for nitrogen and phosphorus
- ▶ Awards grants to states, watershed groups, and wastewater facilities to address nutrient-driven water quality problems
- ▶ Oversees permits that restrict nutrient discharges from industries
- ▶ Conducts research
- ▶ Works with state and federal partners on the Mississippi River/Gulf of Mexico Watershed Nutrient Taskforce to reduce the dead zone in the Gulf

State environmental agencies are working to develop water quality criteria for nutrients. Some states have already developed statewide nutrient criteria for certain types of water bodies. Other states have developed site-specific nutrient criteria. Still others are just beginning to develop criteria and have identified important milestones toward proposing and approving nutrient criteria.

## What Can You Do?

We can all take action to reduce nutrient pollution through the choices we make on our farms, around our homes, with our pets, in lawn care and in transportation. Families, individuals, students and teachers can access online resources to find out more about the health of their local waterways and to learn how to join community efforts to restore and protect them for the benefit of people and wildlife. A variety of resources and links is provided online at [www.epa.gov/nutrientpollution](http://www.epa.gov/nutrientpollution).

### For More Information

Contact: Travis Loop, EPA Office of Water  
202-564-0183, [loop.travis@epa.gov](mailto:loop.travis@epa.gov)

### On the Web, visit:

EPA Nutrient Pollution website:  
[www.epa.gov/nutrientpollution](http://www.epa.gov/nutrientpollution)

Natural Resources Conservation Service website:  
[www.nrcs.usda.gov/wps/portal/nrcs/main/national/water](http://www.nrcs.usda.gov/wps/portal/nrcs/main/national/water)

U.S. Geological Survey website:  
<http://water.usgs.gov/nawqa/nutrients/>

April 2012

## Section 6

### Alkalinity

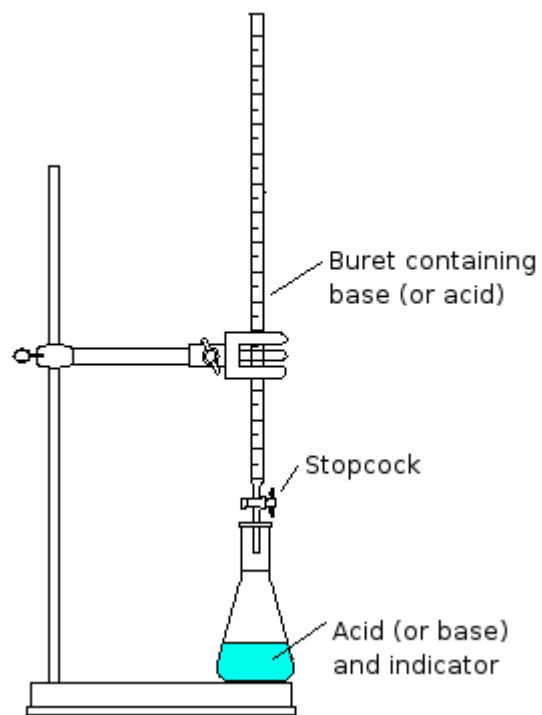



**Measurement of Alkalinity  
for Process Control**  
Wastewater Lab

TDEC - Fleming Training Center 1

## Introduction

- Alkalinity is a general measure of the ionic characteristics of water.
  - Others: pH, oxidation-reduction potential (a.k.a. redox potential), hardness, and conductivity.
  - Not normally a compliance-monitoring requirement.
- TDEC - Fleming Training Center 2

## Alkalinity

- Defined as the measurement of a water's capacity to neutralize an acid
  - An acid releases  $H^+$
  - The alkalinity in the water will absorb  $H^+$
  - Most common ions that add alkalinity are  $OH^-$ ,  $CO_3^-$ ,  $HCO_3^-$  (the major form of alkalinity in natural waters)
- TDEC - Fleming Training Center 3

## Importance in Wastewater Treatment

- Chemical and biological treatment systems
    - High alkalinity WW allows a WWTP to better survive an acidic industrial discharge.
  - Biological nutrient removal
    - Nitrification consumes alkalinity
    - Denitrification generates alkalinity
  - Anaerobic digestion control
    - Volatile Acids/Alkalinity Relationship
  - Ammonia removal by air stripping
- TDEC - Fleming Training Center 4

## Activated Sludge Alkalinity

- Essential to process control
  - Insufficient alkalinity:
    - Reduces organism activity
    - May result in low effluent pH
    - May result in extremely high chlorine demand in disinfection process
- TDEC - Fleming Training Center 5

## Importance in Biological Nutrient Removal

- 7.1 mg  $CaCO_3$  alkalinity depleted per mg nitrogen oxidized (nitrification)
    - Can cause a pH drop if sufficient alkalinity is not present
  - Alkalinity is the best water quality indicator to monitor an enhanced nitrogen oxidation process
  - 3.6 mg  $CaCO_3$  alkalinity recovered during denitrification (regain ~40% lost)
- TDEC - Fleming Training Center 6



### Importance in Anaerobic Digestors

- Volatile Acid/Alkalinity Relationship
- Sufficient alkaline material needed to buffer the acid stage and maintain process
- As long as volatile acids remain low and alkalinity stays high, anaerobic sludge digestion will occur in a digester.
- First warning sign that trouble is starting in digester: when ratio starts to increase

TDEC - Fleming Training Center 7

### Importance in Ammonia Removal by Air Stripping

- Ammonium ( $\text{NH}_4^+$ ) converted to ammonia gas ( $\text{NH}_3$ ) by raising pH
- Feed lime to increase pH to 11
- At pH 11 and 25°C, 98% of ammonia is in gaseous form and will evaporate into the air

TDEC - Fleming Training Center 8

### Alkalinity Determination

- Titration against a standard acid:
  - Color change of standard indicator
  - pH meter
- Results expressed as total alkalinity, mg/L as calcium carbonate
- Buret Titration Method, SM 2320 B

TDEC - Fleming Training Center 9

### Alkalinity Determination

- Measured by determining the amount of acid needed to drop the pH of a sample to a certain endpoint
  - Phenolphthalein alkalinity is measured by titrating to a pH of 8.3
  - Total alkalinity is measured by titrating to a pH of 4.5

TDEC - Fleming Training Center 10

### pH End Points (Hach method 8221)

Sample Composition	End Point pH	
	Total Alkalinity	Phenolphthalein Alkalinity
Alk ~ 30 mg/L	pH 4.9	pH 8.3
Alk ~ 150 mg/L	pH 4.6	pH 8.3
Alk ~ 500 mg/L	pH 4.3	pH 8.3
Silicates or Phosphates present	pH 4.5	pH 8.3
Industrial Waste or Complex System	pH 4.5	pH 8.3
Routine or Automated Process	pH 4.5	pH 8.3

TDEC - Fleming Training Center 11

### Other Methods available

- Standard Method 2320 B. Titration method
- Hach Method 8221
- Hach Method 8203
- Orion pH probe
- Hach method 10239, TNT plus 870

TDEC - Fleming Training Center 12

## Alkalinity

- Alkalinity caused by  $\text{OH}^-$  is called
  - hydroxide alkalinity
- Alkalinity caused by  $\text{CO}_3^{2-}$  is called
  - carbonate alkalinity
- Alkalinity caused by  $\text{HCO}_3^-$  is called
  - bicarbonate alkalinity
- The combined effect of all three types is called
  - total alkalinity

TDEC - Fleming Training Center

13

## Apparatus

- Buret and stand
- Beaker, 250 mL
- Stir plate
- Stir bar



TDEC - Fleming Training Center

14

## Sampling and Storage

- Collect samples in clean plastic or glass bottles
- Avoid excessive agitation or prolonged exposure to air
- Analyze as soon as possible
  - May be stored for 24 hrs at 4°C
- Warm to room temperature before analysis.

TDEC - Fleming Training Center

15

## Interferences

- Highly colored or turbid samples may mask the color change at the end point.
  - Use a pH meter for these samples.
- Chlorine may interfere with indicators.
  - Add one drop 0.1N sodium thiosulfate to eliminate this interference.

TDEC - Fleming Training Center

16

## Orion pH Probe

- Very simple
- No color change to watch
- Must have a properly calibrated pH meter
- By adding a reagent, the determination of alkalinity is made by measuring the drop in pH and comparing the measurement to a calibration chart that show the relationship between pH and alkalinity
- Not an approved method for reporting.**



TDEC - Fleming Training Center

17

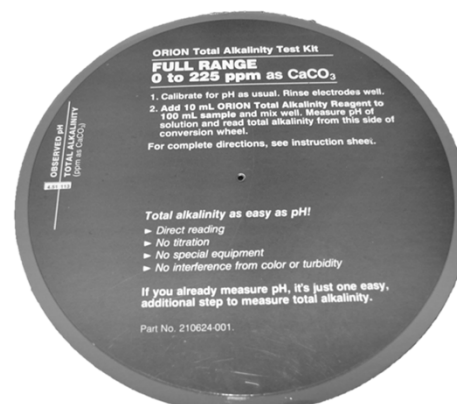

TDEC - Fleming Training Center

18

## Alkalinity in Wastewater

Wastewater Laboratory Class

### What is Alkalinity?

- ▶ The capacity of water to neutralize acids
- ▶ “Buffering Capacity”= ability to resist a change in pH
- ▶ Reported in terms of equivalent calcium carbonate ( $\text{CaCO}_3$ )
- ▶ (For ww) Total Alkalinity, measured to a pH of 4.5 s.u.

### Why is buffering capacity important?

- ▶ Aerobic wastewater operations produce acid
  - Nitrification in aeration tanks, TF, RBCs
  - Nitrification in aerobic digesters
- ▶ Acid formation stage in anaerobic digestion
- ▶ Gas chlorination for effluent disinfection
- ▶ Chemical addition of aluminum or iron salts (aluminum sulfate, ferric sulfate, ferric chloride)
- ▶ Anaerobic conditions in sewer systems
- ▶ Anaerobic conditions in primary clarifiers

### Why is buffering capacity important?

- ▶ When acidic conditions occur, the free hydrogen ( $\text{H}^+$ ) in the acid reacts with the negatively charged alkalinity and the two effectively neutralize each other
- ▶ If ww only contained exact amount of alkalinity needed to neutralize the acids, there wouldn't be enough left over to protect final pH from falling

Remember:

**Alkalinity = Buffering Capacity**

### Why do we need Alkalinity?

- ▶ Alkalinity provides pH stabilization
  - Nitrification is pH sensitive
    - Rates of nitrification decline at  $\text{pH} < 6.8$
    - pH of 7.0-7.2 will maintain reasonable nitrification rates

### Why do we need Alkalinity?

- ▶ Calcium and magnesium are essential elements bacteria need to carry out metabolic functions and reproduce
  - Without these elements, good bacteria could not function properly
  - Result in overabundance of nuisance bacteria

### Why do we need Alkalinity?

- ▶ Lack of carbonate alkalinity will stop nitrification
  - 7.14 mg of alkalinity as  $\text{CaCO}_3$  is used up for every milligram of ammonium ions oxidized during nitrification
- ▶ Alkalinity provides inorganic carbon for nitrifiers

### Why do we need Alkalinity?

- ▶ Alkalinity = stable pH
- ▶ Stable pH = steady state operations
- ▶ Steady state operations = stable environment for microorganisms
- ▶ Stable microorganisms = more efficient

Thus, sufficient alkalinity leads to improved overall performance

### Additional reason

- ▶ Too little alkalinity can keep you from meeting minimum total chlorine residual
  - Plant has an influent alkalinity deficiency
    - Effluent Total Chlorine Residual drop
  - Measure nitrite and nitrate just before chlorine injection point
    - 1 mg/L of Nitrite can consume 5 mg/L of total chlorine residual
  - Measure just Nitrate in chlorine contact chamber
    - If you see a spike, the nitrite was oxidized by the chlorine to nitrate and used up in the reaction
- ▶ Incomplete Nitrification
- ▶ Add alkalinity
- ▶ Allow Denitrification to occur

### Adding Alkalinity

- ▶ Locations with low alkalinity waters will need to add alkalinity to maintain acceptable pH values
- ▶ Common chemicals used to increase alkalinity and pH:
  - Calcium oxide or calcium hydroxide (as lime slurry)
  - Sodium hydroxide (caustic soda)
  - Sodium carbonate (soda ash) or sodium bicarbonate
  - Magnesium hydroxide or magnesium bicarbonate

### Key Points

- ▶ Alkalinity is a useful process control tool
- ▶ Alkalinity creates a stable environment for microorganisms (who are reducing waste)
- ▶ Remember: pH and alkalinity are not the same thing, but there is a relationship
- ▶ Optimum pH range = 7.0-7.4
  - Optimum pH range for nitrification = 8.0 (limited if < 6.0)
- ▶ Oxygen uptake is optimal at 7.0-7.4 pH

### 3 forms of Oxygen available to bacteria

1. Dissolved oxygen ( $O_2$ )
  - Aerobic – use dissolved  $O_2$  to convert food to energy
  - Nitrifiers (class of aerobic bacteria) use ammonia ( $NH_3$ ) for food instead of carbon-based organic compounds = Nitrification
  - Nitrification (aerobic metabolism) uses dissolved  $O_2$  to convert ammonia to nitrate
  - Nitrifiers are the dominant bacteria when organic food supplies have been consumed

### 3 forms of Oxygen available to bacteria

2. Nitrate ions ( $NO_3^-$ )
  - Anoxic metabolism = Denitrification
  - Bacteria utilize nitrate as the source of oxygen
  - Nitrate ion is converted to nitrogen gas when the bacteria converts the food to energy
3. Sulfate ions ( $SO_4^{2-}$ )
  - Anaerobic conditions = bacteria obtain oxygen from sulfate
  - Dissolved  $O_2$  and Nitrate are no longer present
  - Sulfate is converted to hydrogen sulfide and other sulfur-related compounds

### Anoxic Zones

- ▶ Benefits:
1. Filamentous control
  2. Denitrification for nitrogen removal
  3. Reduced energy needs
  4. Alkalinity recovery

### References

- ▶ “Alkalinity and Treatment” by Ron Trygar
- ▶ “How Alkalinity Affects Nitrification” by Mary Evans and Gary Sober

## Alkalinity – Review Questions

### Laboratory portion:

1. Which type of alkalinity did we test for in the lab?
  
2. We measured the above type of alkalinity (answered in question #1) by titrating to a pH endpoint of what?
  
3. What is a titration?
  
4. Which acid did we use in our buret to carry out the titration?
  
5. Which methods did we use in our lab to analyze alkalinity?
  
6. The Hach alkalinity method 8221 requires 0.02N H<sub>2</sub>SO<sub>4</sub> standard solution to be added to the buret. If you were required to make that solution, but you only had 5N H<sub>2</sub>SO<sub>4</sub> available, how many mL of 5N H<sub>2</sub>SO<sub>4</sub> would it take to create 1L of 0.02N H<sub>2</sub>SO<sub>4</sub> solution? Use the  $C_1V_1=C_2V_2$  equation for this.
  
7. We conducted an experiment in the lab using aerator influent. Two beakers of the wastewater were stirred for one hour, allowed to settle, and then the supernatant was analyzed to determine alkalinity concentrations. The following questions pertain to that experiment.
  - a. What was added to one of the beakers?
  
  - b. What were we hoping to accomplish by adding that?
  
  - c. Our beakers were stirred to ensure adequate mixing, but no dissolved oxygen was added. This experiment was trying to simulate what type of “zone” that is commonly used in the activated sludge process?
  
  - d. What happens during denitrification?

- e. After the contents of the beakers had settled out, we tested the supernatant to determine alkalinity levels. Which beaker did we expect to have higher alkalinity levels and why?
- f. How much alkalinity is recovered during the denitrification process?

Classroom portion:

8. What is the definition of alkalinity?
9. Alkalinity is also described as the water's "Buffering Capacity." What does that mean?
10. Why is buffering capacity important? List some examples of why alkalinity is important to wastewater treatment.
11. What are potential interferences in the alkalinity test?
12. What could happen if there is insufficient alkalinity in your wastewater?
13. Alkalinity results are reported in what terms/units?
14. Write the names of the following most common ions that add alkalinity to water:
  - a.  $\text{OH}^-$
  - b.  $\text{CO}_3^-$
  - c.  $\text{HCO}_3^-$
15. How much alkalinity is lost during the nitrification process? And how much of that is recovered during the denitrification process?
16. If your influent ammonia concentration is 30 mg/L, how much alkalinity would be necessary for complete nitrification to occur?

# Alkalinity

## Phenolphthalein and Total Alkalinity<sup>1</sup>

Method 8221

0 to 5000 mg/L as CaCO<sub>3</sub>

Buret Titration

**Scope and application:** For water, wastewater and seawater.

<sup>1</sup> This procedure can be used for *Standard Methods for the Examination of Water and Wastewater* 2320 B for USEPA NPDES reporting.



### Test preparation

#### Before starting

A pH meter must be used for NPDES reporting and is recommended for best results.

As an alternative to the Bromcresol Green-Methyl Red Indicator Powder Pillow, use 4 drops of Bromcresol Green-Methyl Red Indicator Solution.

As an alternative to the Phenolphthalein Indicator Powder Pillow, use 4 drops of Phenolphthalein Indicator Solution.

Color or turbidity in the sample can make it difficult to see the color change at the endpoint. For these samples, use a pH meter to determine the titration endpoint. Refer to [Alkalinity pH endpoints](#) on page 3.

Review the Safety Data Sheets (MSDS/SDS) for the chemicals that are used. Use the recommended personal protective equipment.

Dispose of reacted solutions according to local, state and federal regulations. Refer to the Safety Data Sheets for disposal information for unused reagents. Refer to the environmental, health and safety staff for your facility and/or local regulatory agencies for further disposal information.

#### Items to collect

Description	Quantity
Bromcresol Green-Methyl Red Indicator Powder Pillow	1
Phenolphthalein Indicator Powder Pillow	1
Sulfuric Acid Standard Solution, 0.020 N	varies
pH meter and probe (for samples that have a lot of color or turbidity)	1
Buret, Class A, 25 mL	1
Graduated cylinder (use a size that is applicable to the selected sample volume), or TenSette pipet with tips	1
Erlenmeyer flask, 250 mL	1
Funnel, micro	1
Support stand with buret clamp	1
Water, deionized	varies

Refer to [Consumables and replacement items](#) on page 5 for order information.

#### Sample collection

- Collect samples in clean glass or plastic bottles with tight-fitting caps. Completely fill the bottle and immediately tighten the cap.
- Prevent agitation of the sample and exposure to air.
- Analyze the samples as soon as possible for best results.
- If immediate analysis is not possible, keep the samples at or below 6 °C (43 °F) for a maximum of 24 hours. If there is biological activity in the sample, analyze the sample within 6 hours.



- Let the sample temperature increase to room temperature before analysis.

## Test procedure

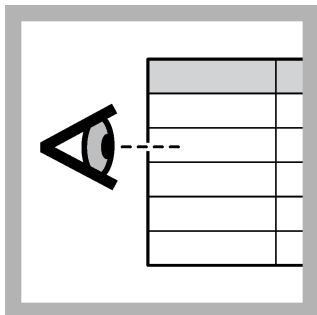

1. Select a sample volume and titrant from [Table 1](#) on page 3.

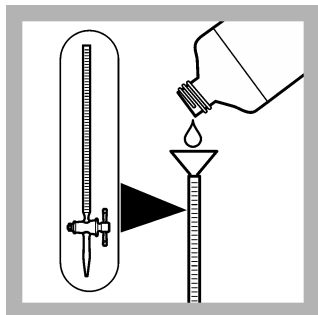

2. Fill a 25-mL buret to the zero mark with the titrant.

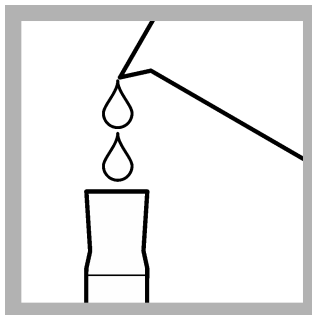

3. Use a graduated cylinder or pipet<sup>1</sup> to measure the sample volume from [Table 1](#) on page 3.

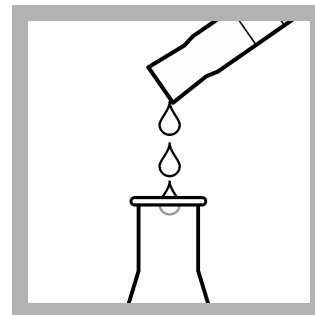

4. Pour the sample into a clean, 250-mL Erlenmeyer flask.

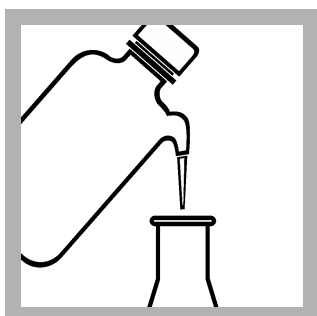

5. If the sample volume is less than 50 mL, dilute to approximately 50 mL with deionized water.

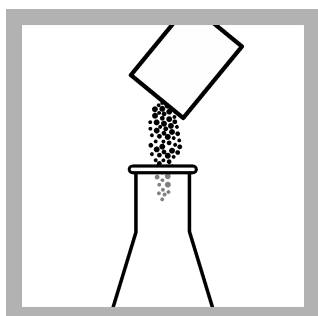

6. Add the contents of one Phenolphthalein Indicator Powder Pillow. The indicator is not necessary if a pH meter is used.

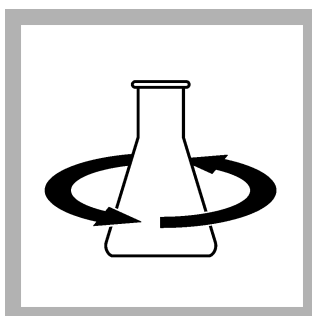

7. Swirl to mix. If the solution is colorless or the pH is less than 8.3, the Phenolphthalein alkalinity is zero. Go to step [10](#).

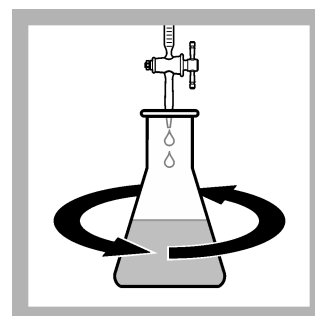

8. Put the flask under the buret. Swirl the flask. Add titrant until the color changes from pink to colorless, or until the pH is 8.3. Do not fill the buret again..

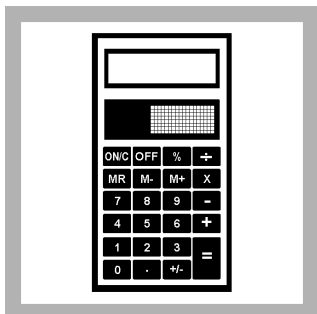

9. Use the multiplier in [Table 1](#) on page 3 to calculate the concentration. mL of titrant  $\times$  multiplier = mg/L as CaCO<sub>3</sub> Phenolphthalein alkalinity.

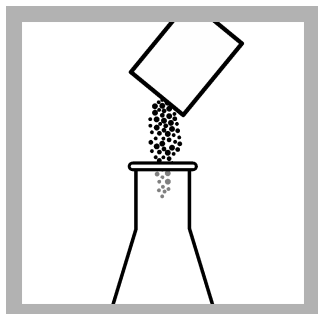

10. Add the contents of one Bromocresol Green-Methyl Red Indicator Powder Pillow. The indicator is not necessary if a pH meter is used.

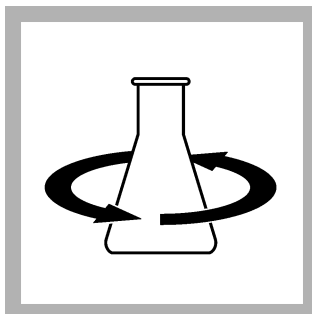

11. Swirl to mix.

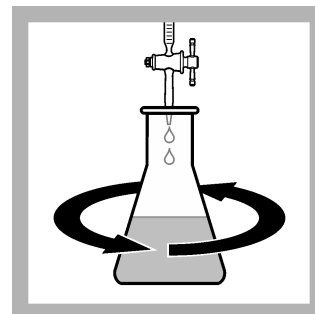

12. Put the flask under the buret. Swirl the flask. Add titrant until the color changes to a light pink color, or the pH is 4.5 (refer to [Table 2](#) on page 3 for additional pH endpoints).

<sup>1</sup> Titration accuracy has a direct relation to the accuracy of the sample volume measurement. For smaller volumes, it is recommended to use a pipet to increase accuracy.

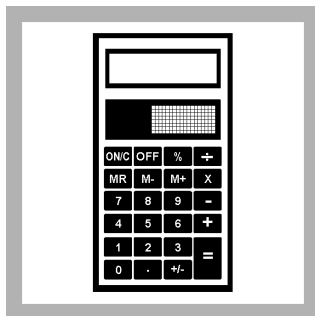
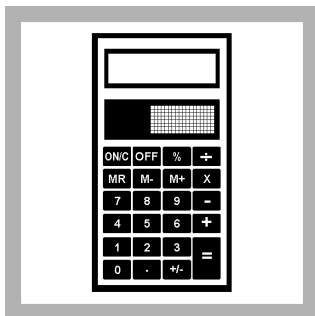

13. Use the multiplier in [Table 1](#) on page 3 to calculate the concentration.  $\text{mL of titrant} \times \text{multiplier} = \text{mg/L as CaCO}_3 \text{ Total alkalinity}$ .

14. Calculate the bicarbonate, carbonate and hydroxide alkalinities as shown in [Determine the alkalinity relationships](#) on page 3.

### Sample volumes and multipliers

Select a range in [Table 1](#), then read across the table row to find the applicable information for this test. Use the multiplier to calculate the concentration in the test procedure.

**Example:** A 50-mL sample was titrated with 0.020 N titrant and 12 mL of titrant was used at the endpoint. The concentration is  $12 \text{ mL} \times 20 = 240 \text{ mg/L as CaCO}_3 \text{ alkalinity}$ .

**Table 1 Sample volumes and multipliers**

Range (mg/L)	Sample volume (mL)	Titrant—sulfuric acid	Multiplier
1–500	50	0.020 N	20
400–1000	25	0.020 N	40
1000–2000	10	0.020 N	100
2000–5000	5	0.020 N	200

### Alkalinity pH endpoints

The titration pH endpoints in [Table 2](#) are recommended for alkalinity determinations in water samples of various compositions and alkalinity concentrations.

**Table 2 Alkalinity pH endpoints**

Sample composition	Phenolphthalein alkalinity	Total alkalinity
Alkalinity approximately 30 mg/L	pH 8.3	pH 4.9
Alkalinity approximately 150 mg/L	pH 8.3	pH 4.6
Alkalinity approximately 500 mg/L	pH 8.3	pH 4.3
Contains silicates or phosphates	pH 8.3	pH 4.5
Industrial wastes or complex system	pH 8.3	pH 4.5
Routine or automated analyses	pH 8.3	pH 4.5

### Determine the alkalinity relationships

The primary forms of alkalinity in water are hydroxide, carbonate and bicarbonate ions. The concentration of these ions in a sample can be determined from the phenolphthalein alkalinity and total alkalinity values. Refer to [Table 3](#) and the steps that follow to determine the hydroxide, carbonate and bicarbonate alkalinities.

1. If the phenolphthalein (P) alkalinity is 0 mg/L, use Row 1.
2. If the phenolphthalein (P) alkalinity is equal to the total alkalinity, use Row 2.

3. Divide the total alkalinity by 2 to calculate one-half of the total alkalinity.
  - a. Compare the phenolphthalein (P) alkalinity to one-half of the total alkalinity. Then, use Row 3, 4 or 5.
  - b. Do the calculations in the row (if applicable).
4. Make sure that the sum of the three alkalinity types is equal to the total alkalinity.

**Example:**

A sample has 170 mg/L as CaCO<sub>3</sub> phenolphthalein alkalinity and 250 mg/L as CaCO<sub>3</sub> total alkalinity.

The phenolphthalein alkalinity of 170 mg/L is more than one-half of the total alkalinity, so use Row 5.

- Hydroxide alkalinity:  $2 \times 170 = 340$ ;  $340 - 250 = 90$  mg/L hydroxide alkalinity
- Carbonate alkalinity:  $250 - 170 = 80$ ;  $80 \times 2 = 160$  mg/L carbonate alkalinity
- Bicarbonate alkalinity: 0 mg/L

Sum of the alkalinity types: 90 mg/L hydroxide alkalinity + 160 mg/L carbonate alkalinity + 0 mg/L bicarbonate alkalinity = 250 mg/L total alkalinity.

**Table 3 Alkalinity relationships**

Row	Titration result	Hydroxide alkalinity	Carbonate alkalinity	Bicarbonate alkalinity
1	P alkalinity = 0	0	0	= Total alkalinity
2	P alkalinity = Total alkalinity	= Total alkalinity	0	0
3	P alkalinity is less than ½ of Total alkalinity	0	= P alkalinity × 2	= Total alkalinity – (P alkalinity × 2)
4	P alkalinity = ½ Total alkalinity	0	= Total alkalinity	0
5	P alkalinity is more than ½ Total alkalinity	= (P alkalinity × 2) – Total alkalinity	= (Total alkalinity – P alkalinity) × 2	0

**Conversions**

To change the units or chemical form of the test result, multiply the test result by the factor in [Table 4](#).

**Table 4 Conversions**

mg/L as CaCO <sub>3</sub> to...	multiply by...	Example
meq/L as CaCO <sub>3</sub>	0.02	1000 mg/L alkalinity as CaCO <sub>3</sub> × 0.02 = 20 meq/L alkalinity as CaCO <sub>3</sub>
Grains per gallon (gpg)	0.0584	500 mg/L alkalinity as CaCO <sub>3</sub> × 0.0584 = 29.20 gpg alkalinity as CaCO <sub>3</sub>

**Interferences**

Interfering substance	Interference level
Chlorine	Chlorine at levels more than 3.5 mg/L can cause a yellow-brown color when the Bromcresol Green-Methyl Red Powder Pillow is added. Add 1 drop of 0.1 N Sodium Thiosulfate to the sample to remove chlorine before the test is started.
Color or turbidity	Color or turbidity can make it difficult to see the color change at the endpoint. Do not filter or dilute samples with color or turbidity. Use a pH meter and titrate the samples to a pH of 8.3 for phenolphthalein alkalinity. For total alkalinity, refer to <a href="#">Table 2</a> on page 3 for the correct endpoint pH.
Soaps, oily matter, suspended solids and precipitates	Oils or solids can collect on the pH probe and cause a slow response. Clean the probe immediately after use (refer to <a href="#">Clean the pH probes</a> on page 5).

## Clean the pH probes

Make sure to clean the pH probes regularly when a pH meter is used to determine the endpoint. Refer to the probe documentation for maintenance instructions. Use the cleaning solution that is specified for the type of contamination that is in the sample. Clean the probe when one or more of the conditions that follow occur:

- Drifting/inaccurate readings
- Slow stabilization times
- Calibration errors

## Accuracy check

### Standard additions method (sample spike)

Use the standard additions method to validate the test procedure, reagents, apparatus, technique and to find if there is an interference in the sample.

Items to collect:

- Alkalinity Standard Solution, 0.500 N (25-g/L as  $\text{CaCO}_3$ )
  - Ampule Breaker
  - Pipet, TenSette, 0.1–1.0 mL and pipet tips
1. Use the test procedure to measure the concentration of the sample.
  2. Use a TenSette pipet to add 0.1 mL of the standard solution to the titrated sample.
  3. Titrate the spiked sample to the endpoint. Record the mL of titrant added.
  4. Add one more 0.1-mL addition of the standard solution to the titrated sample.
  5. Titrate the spiked sample to the endpoint. Record the mL of titrant added.
  6. Add one more 0.1-mL addition of the standard solution to the titrated sample.
  7. Titrate the spiked sample to the endpoint. Record the mL of titrant added.
  8. Compare the actual result to the correct result. The correct result for this titration is 2.5 mL of titrant for each 0.1-mL addition of the standard solution. If much more or less titrant was used, there can be a problem with user technique, reagents, apparatus or an interference.

## Summary of method

A phenolphthalein indicator is added to the sample. Then, the sample is titrated with a sulfuric acid solution. The phenolphthalein indicator changes color at the endpoint pH of 8.3. This value indicates the phenolphthalein (P) alkalinity and is a measure of the total hydroxide and one-half of the carbonate in the sample.

A bromocresol green-methyl red indicator is added and the titration continues to the second endpoint at a pH between 4.3 and 4.9. This value indicates the total (T) alkalinity and is a measure of all carbonate, bicarbonate and hydroxide in the sample. The endpoint pH is determined with color indicators or with a pH meter.

## Consumables and replacement items

### Required reagents

Description	Quantity/Test	Unit	Item no.
Bromocresol Green-Methyl Red Indicator Powder Pillows	1 pillow	100/pkg	94399
Phenolphthalein Indicator Powder Pillows	1 pillow	100/pkg	94299
Sulfuric Acid Standard Solution, 0.020 N	varies	1 L	20353
Water, deionized	varies	4 L	27256

**Required apparatus**

Description	Quantity/test	Unit	Item no.
Buret clamp, double	1	each	32800
Buret, Class A, 25 mL	1	each	2636540
Support stand	1	each	56300
Funnel, micro	1	each	2584335
Graduated cylinders—Select one or more for the sample volume:			
Cylinder, graduated, 5 mL	1	each	50837
Cylinder, graduated, 10 mL	1	each	50838
Cylinder, graduated, 25 mL	1	each	50840
Cylinder, graduated, 50 mL	1	each	50841
Cylinder, graduated, 100 mL	1	each	50842
Tensette <sup>®</sup> pipets and pipet tips—Select one or more for the sample volume:			
Pipet, TenSette <sup>®</sup> , 0.1–1.0 mL	1	each	1970001
Pipet tips, TenSette <sup>®</sup> Pipet, 0.1–1.0 mL	varies	50/pkg	2185696
Pipet, TenSette <sup>®</sup> , 1.0–10.0 mL	1	each	1970010
Pipet tips, TenSette <sup>®</sup> Pipet, 1.0–10.0 mL	varies	50/pkg	2199796
Flask, Erlenmeyer, 250 mL	1	each	50546

**Recommended standards**

Description	Unit	Item no.
Alkalinity Voluette <sup>®</sup> Ampule Standard Solution, 0.500 N (25 g/L as CaCO <sub>3</sub> ), 10-mL	16/pkg	1427810

**Optional reagents and apparatus**

Description	Unit	Item no.
Ampule Breaker, 10-mL Voluette <sup>®</sup> Ampules	each	2196800
Bromcresol Green-Methyl Red Indicator Solution	100 mL MDB	2329232
Buffer Powder Pillows, pH 8.3	25/pkg	89868
Clippers	each	96800
Phenolphthalein Indicator Solution, 5-g/L	100 mL MDB	16232
Sodium Thiosulfate Standard Solution, 0.1 N	100 mL	32332
Stir bar, octagonal	each	2095352
TitraStir <sup>®</sup> Titration Stand, 115 VAC	each	1940000
TitraStir <sup>®</sup> Titration Stand, 230 VAC	each	1940010



FOR TECHNICAL ASSISTANCE, PRICE INFORMATION AND ORDERING:  
 In the U.S.A. – Call toll-free 800-227-4224  
 Outside the U.S.A. – Contact the HACH office or distributor serving you.  
 On the Worldwide Web – [www.hach.com](http://www.hach.com); E-mail – [techhelp@hach.com](mailto:techhelp@hach.com)

HACH COMPANY  
 WORLD HEADQUARTERS  
 Telephone: (970) 669-3050  
 FAX: (970) 669-2932

# Alkalinity, Total

**Colorimetric Method**  
**25 to 400 mg/L CaCO<sub>3</sub>**

**Method 10239**  
**TNTplus™ 870**

**Scope and application:** For drinking water, wastewater and boiler water.



## Test preparation

### Instrument-specific information

Table 1 shows all of the instruments that have the program for this test. The table also shows the adapter and light shield requirements for the applicable instruments that can use TNTplus vials.

To use the table, select an instrument, then read across to find the applicable information for this test.

**Table 1 Instrument-specific information for TNTplus vials**

Instrument	Adapters	Light shield
DR 6000, DR 5000	—	—
DR 3900	—	LZV849
DR 3800, DR 2800	—	LZV646
DR 1900	9609900 or 9609800 (A)	—

### Before starting

DR 3900, DR 3800, DR 2800: Install the light shield in Cell Compartment #2 before this test is started.

Review the safety information and the expiration date on the package.

The recommended temperature for samples and reagents is 15–25 °C (59–77 °F).

The recommended temperature for reagent storage is 15–25 °C (59–77 °F).

DR 1900: Go to All Programs>LCK or TNTplus Methods>Options to select the TNTplus number for the test. Other instruments automatically select the method from the barcode on the vial.

Review the Safety Data Sheets (MSDS/SDS) for the chemicals that are used. Use the recommended personal protective equipment.

Dispose of reacted solutions according to local, state and federal regulations. Refer to the Safety Data Sheets for disposal information for unused reagents. Refer to the environmental, health and safety staff for your facility and/or local regulatory agencies for further disposal information.

### Items to collect

Description	Quantity
Total Alkalinity TNT870 Reagent Set	1
Pipet, adjustable volume, 1.0–5.0 mL	1
Pipet, adjustable volume, 0.2–1.0 mL	1
Pipet tips	1

Refer to [Consumables and replacement items](#) on page 3 for order information.

## Sample collection

- Collect samples in clean glass or plastic bottles with tight-fitting caps. Completely fill the bottle and immediately tighten the cap.
- Prevent agitation of the sample or exposure to air.
- Analyze the samples as soon as possible for best results.
- If immediate analysis is not possible, keep the samples at or below 6 °C (43 °F) for a maximum of 24 hours.
- Let the sample temperature increase to room temperature before analysis.

## Test procedure



1. Use a pipet to add 2.0 mL of Solution A to the test vial.

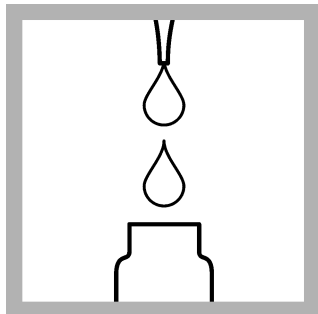

2. Use a pipet to add 0.5 mL of sample to the test vial.

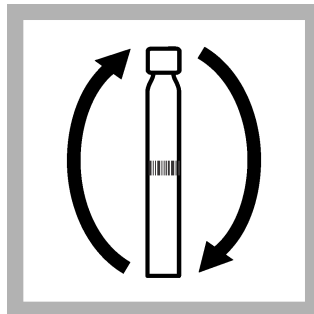

3. Tighten the cap on the vial and invert until completely mixed. Make sure that the contents are well mixed.

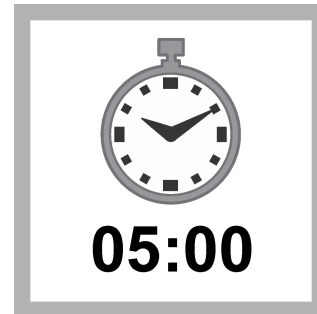

4. Start the reaction time of 5 minutes.

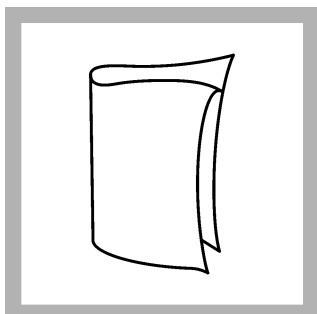

5. When the timer expires, clean the vial.

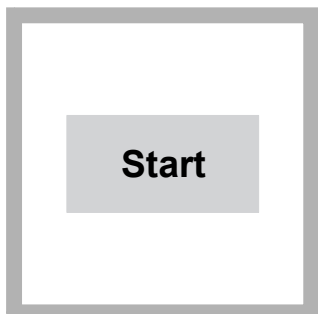

6. DR 1900 only: Select program 870. Refer to [Before starting](#) on page 1.

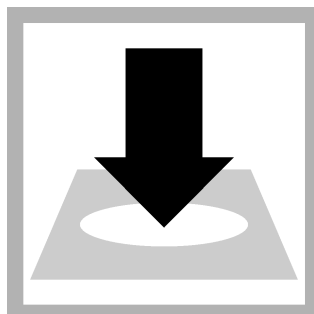

7. Insert the vial into the cell holder. DR 1900 only: Push **READ**. Results show in mg/L CaCO<sub>3</sub>.

## Interferences

If the samples contain particles, use a 0.45 µm filter to remove the particles.

## Accuracy check

### Standard solution method

Use the standard solution method to validate the test procedure, the reagents and the instrument.

Items to collect:

- 25,000-mg/L CaCO<sub>3</sub> Alkalinity Voluette® Ampule Standard Solution
- Ampule breaker
- 100-mL volumetric flask, Class A
- Pipet, adjustable volume, 1–5 mL with pipet tips
- Deionized water

1. Prepare a 250-mg/L CaCO<sub>3</sub> standard solution as follows:
  - a. Use a pipet to add 1.0 mL of the standard solution into the volumetric flask.
  - b. Dilute to the mark with deionized water. Mix well. Prepare this solution daily.
2. Use the test procedure to measure the concentration of the prepared standard solution.
3. Compare the expected result to the actual result.

*Note: The factory calibration can be adjusted slightly with the standard adjust option so that the instrument shows the expected value of the standard solution. The adjusted calibration is then used for all test results. This adjustment can increase the test accuracy when there are slight variations in the reagents or instruments.*

## Summary of Method

Carbonates and other buffers react with the reagent in the vial to change the pH. The pH has an effect on the color of the indicator, which is measured photometrically. The measurement wavelength is 615 nm.

## Consumables and replacement items

### Required reagents

Description	Quantity/Test	Unit	Item no.
Total Alkalinity TNT870 Reagent Set	1	25/pkg	TNT870

### Required apparatus

Description	Quantity/test	Unit	Item no.
Pipet, adjustable volume, 1.0–5.0 mL	1	each	BBP065
Pipet tips, for 1.0–5.0 mL pipet	1	75/pkg	BBP068
Pipet, adjustable volume, 0.2–1.0 mL	1	each	BBP078
Pipet tips, for 0.2–1.0 mL pipet	2	100/pkg	BBP079
Light shield, DR 3900	1	each	LZV849
Light shield, DR 3800, DR 2800, DR 2700	1	each	LZV646

### Recommended standards

Description	Unit	Item no.
Alkalinity Voluette <sup>®</sup> Ampule Standard Solution, 25,000-mg/L CaCO <sub>3</sub> , 10-mL	16/pkg	1427810

### Optional reagents and apparatus

Description	Unit	Item no.
Ampule Breaker, 10-mL Voluette <sup>®</sup> Ampules	each	2196800
Filter membrane, 0.45-micron, 25-mm	100/pkg	2514101
Filter holder, 25-mm, for Luer-type syringe	each	246800
Flask, volumetric, Class A, 100-mL glass	each	1457442
Sampling bottle with cap, low density polyethylene, 500-mL	12/pkg	2087079
Syringe, 10-cc, Luer-Lock tip	each	2202400
Water, deionized	4 L	27256





**FOR TECHNICAL ASSISTANCE, PRICE INFORMATION AND ORDERING:**  
In the U.S.A. – Call toll-free 800-227-4224  
Outside the U.S.A. – Contact the HACH office or distributor serving you.  
On the Worldwide Web – [www.hach.com](http://www.hach.com); E-mail – [techhelp@hach.com](mailto:techhelp@hach.com)

**HACH COMPANY**  
WORLD HEADQUARTERS  
Telephone: (970) 669-3050  
FAX: (970) 669-2932

Alkalinity Lab

	Alkalinity of Tap Water				
	Color change - titrate to pink color		pH probe - titrate to pH of 4.5		Hach TNT 870
Team 1					
Team 2					
Team 3					
Team 4					
Team 5					
Team 6					
Team 7					
Team 8					

## Alkalinity - Denitrification Experiment

		Beaker # 1- No Nitrates Added	Beaker # 2 - Nitrates Added
	Initial Alkalinity	Alkalinity	Alkalinity
Team 1			
Team 2			
Team 3			
Team 4			
Team 5			
Team 6			
Team 7			
Team 8			

Do you see evidence that denitrification took place? Which beaker?

If yes, what indicates that denitrification occurred?

If no, list some possible reasons why denitrification did not occur.

<p><u>Alkalinity - Titrate to pH 4.5 or pink color</u></p> $\text{Alkalinity} = \frac{(\text{ mL titrant used to reach pH of 4.5 })( 0.02 \text{ N H}_2\text{SO}_4 )( 50,000 )}{\text{ mL sample}}$
---

	Influent	Effluent
	mL sample used =	mL sample used =
Bench 1	total mL to pH 4.5 =	total mL to pink =
Bench 2	total mL to pink =	total mL to pH 4.5 =
Bench 3	total mL to pH 4.5 =	total mL to pink =
Bench 4	total mL to pink =	total mL to pH 4.5 =
Bench 5a	total mL to pH 4.5 =	total mL to pink =
Bench 5b	total mL to pink =	total mL to pH 4.5 =

---

Influent Alkalinity - Titrate to pH 4.5 or pink color

$$\text{Alkalinity} = \frac{(\text{mL titrant used to reach pH of 4.5})(0.02 \text{ N H}_2\text{SO}_4)(50,000)}{\text{mL sample}}$$

$$\text{Alkalinity} = \frac{(\text{_____})(0.02 \text{ N H}_2\text{SO}_4)(50,000)}{\text{_____ mL sample}} =$$

---

Effluent Alkalinity - Titrate to pH 4.5 or pink color

$$\text{Alkalinity} = \frac{(\text{total mL titrant used to reach pH of 4.5})(0.02 \text{ N H}_2\text{SO}_4)(50,000)}{\text{mL sample}}$$

$$\text{Alkalinity} = \frac{(\text{_____})(0.02 \text{ N H}_2\text{SO}_4)(50,000)}{\text{_____ mL sample}} =$$

---

Orion Alkalinity Method =

## Alkalinity and treatment

Calcium and magnesium are essential elements bacteria need to carry on metabolic functions and reproduce. Other essential elements include nitrogen, phosphorus, potassium, iron, sulfur, oxygen, carbon and hydrogen. Without these elements present, the bacteria in treatment plants would not function properly, and could result in an over-abundance of nuisance bacteria — the kinds that cause odors or inhibit settling.

We need some alkalinity to buffer against drops in pH values. Processes that biologically produce acids or acidic chemicals include:

- Biological nitrification (the conversion of ammonium to nitrite then nitrate)
- Anaerobic conditions in sewer systems
- Anaerobic conditions in primary clarifiers
- Anaerobic sludge digestion processes
- Anaerobic fermentation basins in biological phosphorus removal systems
- Chemical coagulant addition (aluminum sulfate, ferric sulfate, ferric chloride)
- Pure gaseous chlorine for disinfection

When these biological conditions occur in a treatment plant, or when acidic chemicals are added, the free hydrogen (H<sup>+</sup>) in the acid reacts with the negatively charged alkalinity, and the two effectively neutralize each other. If the water contained only the exact amount of alkalinity required to neutralize the acids, there would not be enough alkalinity remaining to protect the final pH value from falling if any additional acid were formed or added downstream.

Biological processes like nitrification and anaerobic digestion rely on alkalinity. Without alkalinity, organic acids formed during these processes would drive the pH down to a point where the bacteria would be inhibited or could no longer survive.

For instance, during the acid-formation stage of anaerobic digestion, volatile fatty acids are produced as acid-forming bacteria feed on the viscous, nearly septic sludge. A second group of bacteria, methanogens, then consume the volatile fatty acids. From this reaction, methanogens produce methane and bicarbonate alkalinity. The alkalinity they produce helps buffer the acid produced by the volatile acid formers.

In a properly operated anaerobic digester, the ratio of volatile acid to alkalinity is between 0.1 to 0.25 parts acid for every one part alkalinity per liter. If a digester is overfed and volatile acids are rapidly increasing, the methane formers can't consume the acids fast enough. This causes the alkalinity to become depleted.

For example, if the volatile acid climbs rapidly to 1,500 mg/L and the alkalinity is steady at 3,000 mg/L as CaCO<sub>3</sub>, then the ratio becomes 0.5:1, and methane production slows down or even stops. If the operator does not take corrective action, the digester may become sour and stop working completely. In fact, if the operator did not pay attention to alkalinity and used pH as the sole operating process control parameter, the digester could become sour before the pH finally indicated an operating problem.

## Supplementing alkalinity

If the alkalinity present in the influent is not sufficient, or if there is a need to increase alkalinity in the treatment plant, chemical addition can help correct the deficiency. Common chemicals used to increase alkalinity and pH include:

- Calcium oxide or calcium hydroxide (as lime slurry)
- Sodium hydroxide (caustic soda)
- Sodium carbonate (soda ash) or sodium bicarbonate
- Magnesium hydroxide or magnesium bicarbonate

Sodium hypochlorite (bleach) and calcium hypochlorite (granular chlorine) will raise the liquid pH and alkalinity while performing as disinfectants. Care must be taken when using these chemicals, not only because of their very high pH and corrosive effects, but also because of the dangerous chemical reactions that occur when they are added to low-pH liquids and biosolids. Always handle chemicals with caution; read and follow the recommendations found on the MSDS documents and labels.

In summary, alkalinity can be a useful process control tool. Keeping an eye on the alkalinity coming into the treatment plant, through the various unit processes and in plant effluent can provide clues to biological and chemical changes, sometimes helping prevent process upsets. Remember that pH and alkalinity are not the same thing — they are measurements of two distinct and separate chemical conditions.

## About the author

Ron Trygar is senior training specialist in water and wastewater at the University of Florida TREEO Center and a certified environmental trainer (CET). He can be reached at [rtrygar@treeo.ufl.edu](mailto:rtrygar@treeo.ufl.edu).

## References

Simplified Laboratory Procedures for Wastewater Examination, Third Edition, Water Environment Federation, 1985.

Operation of Wastewater Treatment Plants, Volume II, Sixth Edition, California State University, Sacramento.

Wastewater Residuals Stabilization, MOP FD-9, Water Environment Federation, 1995.

[http://www.tpomag.com/editorial/2014/05/understanding\\_alkalinity](http://www.tpomag.com/editorial/2014/05/understanding_alkalinity)





**Section 7**  
**Activated Sludge Process Control**  
**and Microscopic Evaluation**



## PROCESS CONTROL TESTING



TDEC - Fleming Training Center

### ACTIVATED SLUDGE PROCESS CONTROL

- o What is a process?
  - Continuing operation or development marked by a series of gradual changes that succeed one another in a relatively fixed way and lead toward a particular result or end.



TDEC - Fleming Training Center

### ACTIVATED SLUDGE PROCESS CONTROL

- o What is the wastewater process result or end?
  - Clean Water
  - BOD removal
  - Solids removal
  - Good solids/liquid separation

TDEC - Fleming Training Center

### TREATMENT PLANT PROCESSES

- o Flow Monitoring, Equalization
- o Screening
- o Grit and Grease Removal
- o Activated Sludge
  - Aeration Basin
  - Clarifier
  - RAS/WAS
- o Disinfection



TDEC - Fleming Training Center

### WW TREATMENT & MANUFACTURING

<ul style="list-style-type: none"> <li>o Wastewater                             <ul style="list-style-type: none"> <li>• One raw material</li> <li>• Treatment process                                     <ul style="list-style-type: none"> <li>o Several Steps gradually leading to finished products.</li> </ul> </li> <li>• Finished products                                     <ul style="list-style-type: none"> <li>o Trash, Solid waste rules</li> <li>o Clean Water, Permit</li> <li>o Biosolids, 503 rule</li> </ul> </li> </ul> </li> </ul>	<ul style="list-style-type: none"> <li>o Manufacturing                             <ul style="list-style-type: none"> <li>• Many raw materials</li> <li>• Manufacturing process                                     <ul style="list-style-type: none"> <li>o Several Steps gradually leading to finished products.</li> </ul> </li> <li>• Finished product                                     <ul style="list-style-type: none"> <li>o Sausage, cars, pencils; all of which have quality specifications</li> </ul> </li> </ul> </li> </ul>
---	---

TDEC - Fleming Training Center

### COMMON PROCESS CONTROL METHODS

- o How do you control your activated sludge process?
  - Human senses
    - o Visual appearance, odors
  - Process tests
    - o Flow, D.O., pH, temp., alkalinity, ORP, turbidity
    - o Settlemeter, Sludge judge
    - o MLSS, MLVSS
    - o Centrifuge spins
    - o Microscopic evaluation
    - o Oxygen Uptake Rate, Specific Oxygen Uptake Rate

TDEC - Fleming Training Center

PROCESS CONTROL

- o Test performed in the aeration basin and or clarifier that indicate what the effluent quality will be when the water leaves the treatment plant.
- o There may be a significant time delay from the time water enters the aeration basin and effluent sampling or discharge.
- o Manufactures face similar quality challenge.

TDEC - Fleming Training Center

PROCESS CONTROL

- o What aerator test “now” will assure you of good effluent when that water reaches the effluent several hours latter?

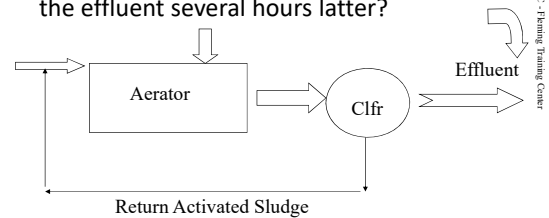

TDEC - Fleming Training Center

PROCESS CONTROL

- o You choose the method that assures you that effluent will meet permit.
- o NPDES permit
  - Part 2.1.4 Proper Operations and Maintenance
    - o “...adequate process controls...”
    - o Though almost hidden, this is a Permit requirement
- o Find a method that works for you and use it!

TDEC - Fleming Training Center

PROCESS CONTROL VS MONITORING TESTS

- o Process control tests are frequently performed by operators to quickly obtain the results and make any necessary process adjustments



PROCESS CONTROL VS MONITORING TESTS

- o NPDES monitoring tests may be performed by operators, but are also performed by laboratory analysts (especially in larger plants)
  - These tests are required by your permit
  - This data is reported to the State
  - BOD, CBOD, Sett. Solids, TSS, TR Chlorine, Ammonia, Total Phosphorus, pH, Temp

TDEC - Fleming Training Center

SENSORY PROCESS CONTROL

- o Odors
  - o Fresh plowed field
  - o Hog pen
- o Turbulence
  - o Boiling, Dead spots
- o Foam and Scum
  - o Fresh, crisp, light-colored foam
  - o Billowing white foam
  - o Thick, scummy, dark foam



### SENSORY PROCESS CONTROL

#### o Clarifier

- Bulking, sludge quality
- Billowing, hydraulic overload
- Clumping, denitrification
- Ashing/Pin Floc, old sludge
- Straggler Floc, young sludge



TDEC - Fleming Training Center

### PROCESS CONTROL

- o Flow Rates, accurate flow measurements of premier importance.
- o Locations
  - Influent Q
  - RAS, WAS, other
- o Dissolved oxygen
  - >0.5mg/L for BOD removal, >2.0 for Ammonia
  - Profiles-longitudinal, vertical
  - DO levels are relative to the oxygen demand

TDEC - Fleming Training Center

### PROCESS CONTROL

- o DO Profile – This is being conducted in the receiving stream, but the same concept applies to aeration basin

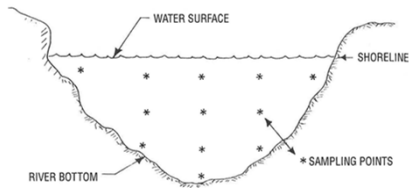

TDEC - Fleming Training Center

15

### PROCESS CONTROL, CONTINUED

- o pH, 5-9 for BOD, 6.5-8 for Ammonia
  - Indicator of toxicity
  - Indicator of nitrification problems
- o Temperature, Above freezing for BOD, 25°C optimal for AM.
  - Use D.O. meter
  - Affects speed of bacterial metabolism, or perhaps no metabolism!

TDEC - Fleming Training Center

### PROCESS CONTROL, CONTINUED

- o Alkalinity, effluent >50mg/L for Ammonia removal
  - Necessary for complete nitrification
- o ORP-Oxidation Reduction Potential, Redox
  - pH meter with ORP probe
  - Indicated the oxidative state of the solution
- o Turbidity
  - Indicator of completeness of flocculation

TDEC - Fleming Training Center

### PROCESS CONTROL, CONTINUED

- o Settleability test (determine settled sludge volume (SSV))
  - Use settleometer not graduated cylinder
  - Indicator of clarifier performance
  - How well the biomass- settles and compacts
- o Sludge Judge, MLSS, MLVSS Centrifuge spins
  - Indicators of biomass inventory



TDEC - Fleming Training Center

### SETTLEOMETER

- o Basic Process Control
- o 5 min - How fast sludge settles
- o 30 min - How well sludge compacts
- o Supernatant turbidity, how well sludge flocculates
- o Denitrification

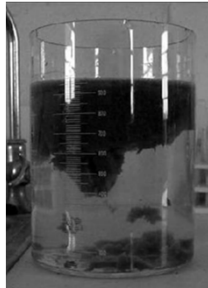

TDEC - Fleming Training Center

### HOW TO PERFORM A SETTLEOMETER TEST (4 MINUTES)

[HTTPS://WWW.YOUTUBE.COM/WATCH?V=GTLKoGG0dM](https://www.youtube.com/watch?v=GTLKoGG0dM)

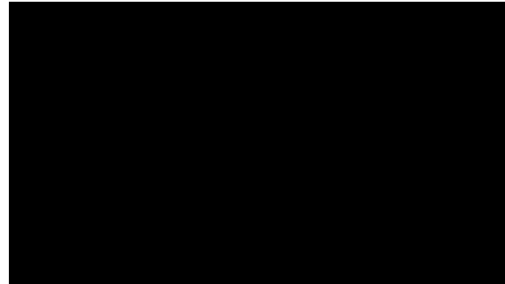

TDEC - Fleming Training Center

### SETTLEOMETER TEST PROCEDURE:

1. Initiate as soon as possible, lengthy delays may contribute to errors.
2. Agitation of the sample may contribute to errors.
3. Pour gently mixed sample into settleometer, filling settleometer to top 1000 ml/L mark.
4. Mix sample in settleometer with wide paddle, rocking back and forth, not twisting.
5. Stop motion in settleometer (hold paddle in place) resulting in sharp interface.
6. Lift mixing paddle directly from settleometer and start timer.

### SETTLEOMETER TEST PROCEDURE CONT...

7. Record actual time of test initiation, t = 0 in case of missed reading
8. Observe first 5 minutes of test
9. Record settled sludge volume at 5-minute intervals for the first thirty minutes of test (for SVI and ultimate compactness for fast settling sludges).
10. Record settled sludge volumes (**SSV**) at 10-minute intervals for the second thirty minutes of test (ultimate compactness for normal settling sludges).

TDEC - Fleming Training Center

### SETTLEOMETER TEST PROCEDURE CONT...

11. For slow settling sludges, record settled sludge volumes at half hour intervals until ultimate compactness. Ultimate compactness is defined as the settled sludge volume at which settling and compacting has ceased in the settleometer. Knowledge of the ultimate compactness value is required for proper return sludge control of slow settling sludges.
12. Record rise time. Rise time is defined as the interval required for the sludge to rise in the settleometer. Knowledge of the rise time changes is indicative of denitrification trends in secondary clarifiers.

### SETTLEOMETER READINGS

SST (min)	SSV (cc/L)
0	1000
5	350
10	250
15	220
20	210
25	200
30	190
40	185
50	180
60	180
2 hrs	
3 hrs	

TDEC - Fleming Training Center

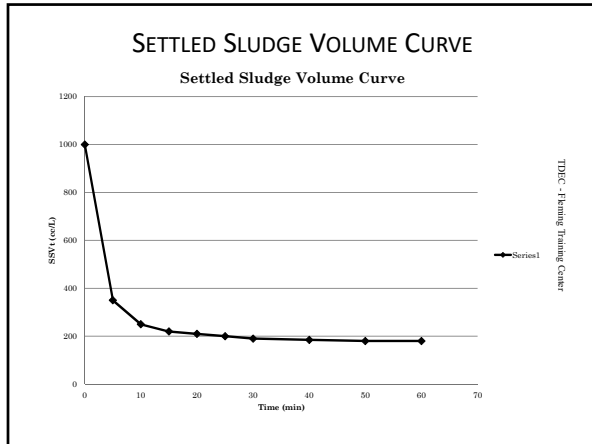

- ### SETTLEOMETER - DATA
- Settled Sludge Volumes (SSV):
    - SSV5, SSV10, SSV15, SSV20, SSV25
    - SSV30 (SVI; fast settling sludge)
    - SSV40, SSV50
    - SSV60 (normal settling sludge)
    - SSV90, SSV120 (ultimate compactness; slow settling sludge)
  - Rise Time (denitrification of sludge)
- TDEC - Fleming Training Center

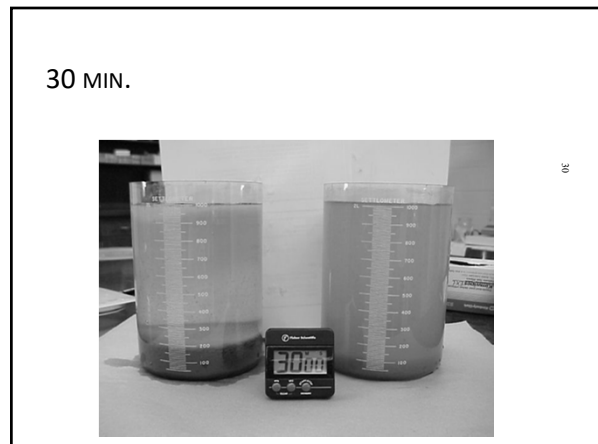

30 MIN.

RIGHT SIDE DISPERSED GROWTH SETTLES POORLY



31

SETTLEOMETER - DATA

- May want to run a diluted sample with 50% effluent and 50% MLSS and compare to the undiluted sample.
- If the diluted samples settle significantly quicker than the undiluted sample (especially during the first 10 minutes), the system contains too many solids and wasting should be increased.

TDEC - Fleming Training Center

5 MIN. UNDILUTED / DILUTED 50/50



33

30 MIN. DILUTED SETTLES BETTER = WASTE!

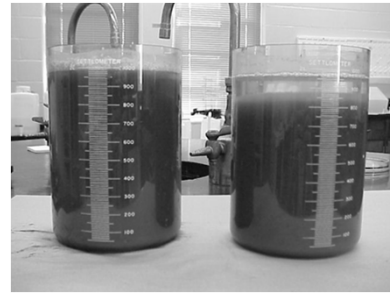

34

SETTLEOMETER - DATA

- If the diluted sample settles at the same rate or only slightly faster than the undiluted sample, the MLSS is young and bulky.
  - This can be caused by excessive wasting
  - To correct, reduce wasting a little each day to develop a sludge that settles better.
- If the sludge settles so slowly that you are losing solids in the effluent, you may need to add polymers to aid in settling.

TDEC - Fleming Training Center

SETTLEOMETER - DATA

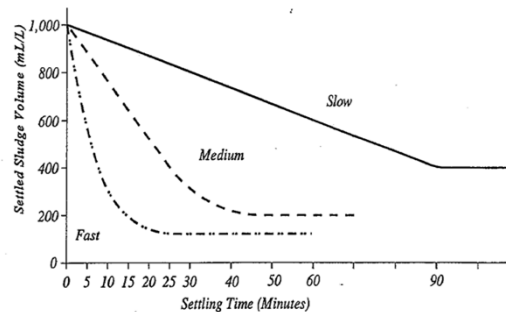

TDEC - Fleming Training Center

### THIRTY-MINUTE SETTLEOMETER

Index of Settleability Test Results

37

### CLARIFIER SOLIDS

- Activated Sludge Process Control:
  - Mallory Cylinder or Settleometer
  - Glass or plastic flat bottom beaker
  - Sample (2 L) settles 30 min, then settled sludge volume read off side of cylinder
  - During test, rate and quality of settling are observed

### SLUDGE VOLUME INDEX (SVI)

- Monitor activated sludge settling behavior for process control
- Calculation using MLSS (mg/L) and 30 min SSV (mL/L)
- $SVI = \frac{(mL/L \text{ after } 30 \text{ min})}{MLSS \text{ mg/L}} \times 1,000$
- Target 100, Range 50-150
- Gives you a better picture of the sludge's characteristics than settleability or MLSS alone

TDEC - Fleming Training Center

### SETTLED SLUDGE CONCENTRATION (SSC)

- Centrifuge test for sludge quality
- Aeration Tank mixed liquor Concentration (ATC)
- Tubes contain 10 mL
- Centrifuge 15 min at 3000 rpm

TDEC - Fleming Training Center

### SETTLED SLUDGE CONCENTRATION (SSC)

- Read level of compacted solids. Multiply result by 10 to obtain sludge concentration or % solids (ATC)
- Can be used on return and waste sludges
- Calculate SSC for any SSV as:
  - $SSC = (1000)(ATC/SSV)$
- Plot settleable vs. centrifuge solids for **quick estimate of settleable solids**

TDEC - Fleming Training Center

### SETTLEOMETER READINGS

SST (min)	SSV (cc/L)	SSC <sub>r</sub> (= 1000 x ATC/SSV)
0	1000	2.5
5	350	7.1
10	250	10.0
15	220	11.4
20	210	11.9
25	200	12.5
30	190	13.2
40	185	13.5
50	180	13.9
60	180	13.9
2 hrs		
3 hrs		

If centrifuge = 0.25, multiply by 10 (as in 10 mL) = 2.5 sludge concentration or % solids ATC

TDEC - Fleming Training Center



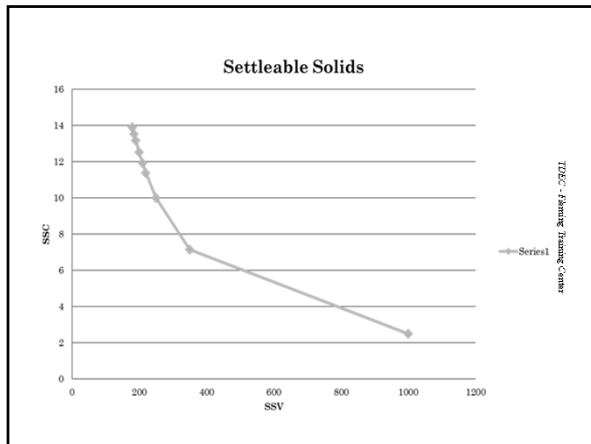

- ### IN SUMMARY
- Slow settling sludge that is OLD will be:
    - Dark brown
    - Settle significantly faster if diluted
    - Foam will be brown, scummy-greasy looking
  - Slow-settling sludge that is YOUNG will be:
    - Light brown to tan
    - Will settle about as fast whether diluted or not
    - Foam will be white and crispy-looking

- ### BIOMASS INVENTORY
- Inventory of Biomass should answer three questions
    - How much sludge is in the system?
    - Where is it located?
    - How long has it been there?
    - Experience has shown us certain sludge ages give us certain effluent qualities.
  - With these answers, process control is easy

- ### BIOMASS INVENTORY/MCRT
- Suspended Solids
    - Aerator
    - Clarifier Core
    - Return Sludge
  - Calculate pounds
  - Calculate MCRT
  - Three methods
    - Traditional MLSS
    - TSS Meter
    - Centrifuge spins
- 

- ### BIOMASS INVENTORY – RULES OF THUMB
- |   |                   |
|---|-------------------|
| ○ BOD Removal                                   | ○ Ammonia Removal |
| ○ MCRT, 0.5-1 Day<br>(Mean Cell Residence Time) | ○ MCRT 4-15 Days  |
- 
- There are exceptions to these rules!!*

- ### MCRT
- The Mean Cell Residence Time (MCRT) is a more precise sludge age calculation.
  - Describes the mean (average) time an activated sludge particle spends in the activated sludge system
  - True measure of the age of the activated sludge
  - Measure representative composite samples of MLSS, effluent SS, and waste sludge SS. Also measure influent and waste sludge flows.
  - Sometimes called Solids Retention Time (SRT)

**MCRT**  
<https://www.youtube.com/watch?v=9EXMWC2UAC4>

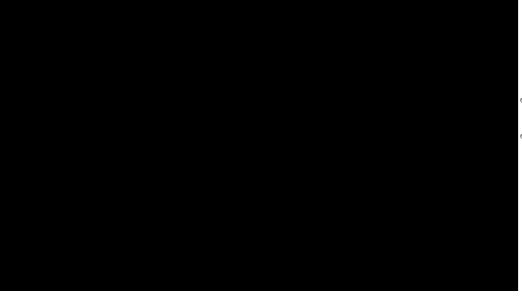

TDEC - Fleming Training Center

**MICROSCOPIC EVALUATION**

- Floc analysis, Jenkins' Book
  - General shape, size, dispersed cells
- Protozoan/ Metazoan counts
  - General indicator of sludge age
- Filaments
  - Abundance, inside/outside flock, bridging
  - Non-Phase microscope, ID- *Nocardia*, *Beggiatoa*
- Slime Bulking
  - India ink test

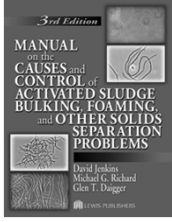

TDEC - Fleming Training Center

**MICROGRAPH OF FLOC AND FILAMENTS**

- Filamentous bacteria are not "floc formers" but are also of interest in WW treatment.
- Small amounts of them can improve floc structure, acting as a backbone, providing mass to help in settling after treatment.
- Large amounts can negatively affect performance of activated sludge systems by keeping floc apart and which makes it light and fluffy, therefore, not settling well.

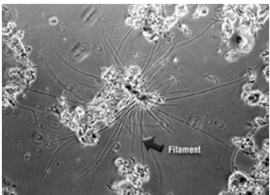

TDEC - Fleming Training Center

**WASTEWATER MICROBIOLOGY (8 MINUTES)**

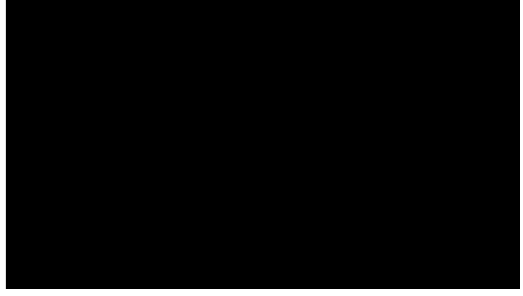

TDEC - Fleming Training Center

**PROTOZOA**

- Single-celled animals that also reproduce by binary fission
- Have complex digestive systems that ingest organic matter, which they use as an energy and carbon source
- Protozoans are much larger than bacteria, their size ranges from 10-500 microns
- They are an important link in the activated sludge food chain because they consume bacteria to fill a large part of their nutritional needs.
  - This seems not only to remove excess bacteria from WW, but appears to stimulate the growth of healthy bacteria, which produce floc more quickly and aid in the clarification of the effluent

TDEC - Fleming Training Center

**PROTOZOA CONTINUED...**

- Form cysts
- Beneficial in ww treatment
- Indicators of health of system
- Examples:
  - Amoeba
  - Free-Swimming Ciliates
  - Crawling Ciliates
  - Stalked Ciliates
  - Suctoria

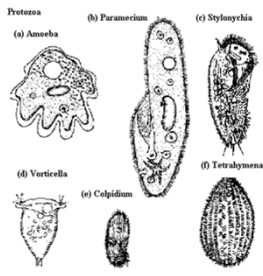

TDEC - Fleming Training Center

**PROTOZOA FOUND IN THE ACTIVATED SLUDGE PROCESS**

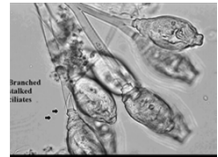
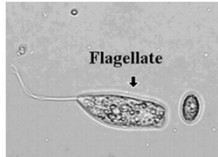

- o Much less abundant than bacteria, but very important.
- o Require DO
- o Flagellate has a whip-like tail and competes with bacteria
- o Stalked ciliates – as adults, attach to something; as a “baby”, has little hairs (cilia) to move around and move water and food into “mouth”

TDEC - Fleming Training Center

**PROTOZOA FOUND IN THE ACTIVATED SLUDGE PROCESS**

- o Euglena – symbiotic relationship with green algae in it
  - Produce oxygen when the sun shines.

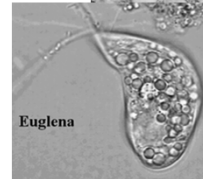
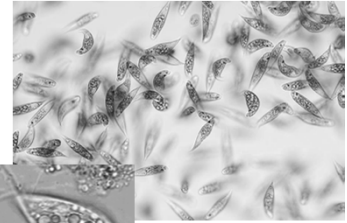

56

**PROTOZOA – AMOEBIA**

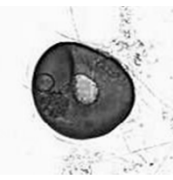
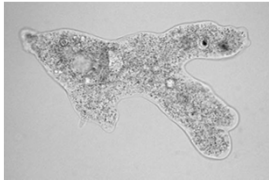

**Video of Amoeba eating**

- o Amoebas don't like being in WW, they encyst themselves to make it through the system
- o Look like donuts
- o Can be found during plant start up or after a plant is recovering from an upset.

TDEC - Fleming Training Center

**PROTOZOA – FREE SWIMMING CILIATE (PARAMECIUM)**

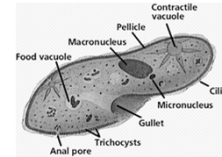
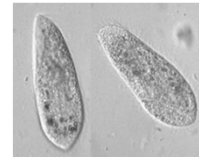

- o Free swimming ciliates generally are younger biomass organisms but are common in many plants.
- o Cilia covers entire shape
- o Sufficient D.O.
- o Asexually & Sexually
- o Paramecium- 4.7 hours growth rate

TDEC - Fleming Training Center

**PROTOZOA – CRAWLING CILIATES**

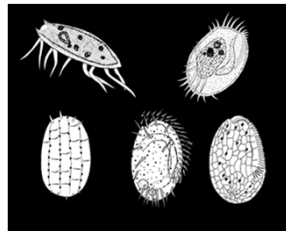
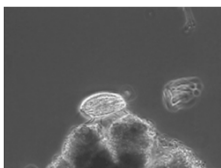

- o Resemble crabs or ladybugs
- o May have some cilia but majority of body does not contain any
- o Croppers of biomass
- o Cirri (A bundle or tuft of cilia serving as foot or tentacle in certain ciliate protozoa) are 4-5 cilia fused together
- o Very efficient feeders

TDEC - Fleming Training Center

**PROTOZOA – STALKED CILIATES**

- o They feed by drawing cells into their “mouth” with small cilia that create a visible twirling motion in the sample.
- o Can be sessile or colonial
- o Length of stalk indicates age
- o Some will have a myoneme (contractile muscle fiber with in stalk)

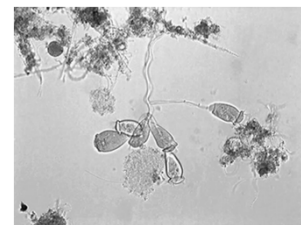

**PROTOZOA – STALKED CILIATES**

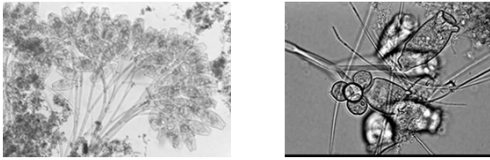

TDEC - Fleming Training Center

- o Some species will produce a daughter cell which resemble a free-swimming ciliate
- o Size of oral opening may indicate health of system / more bacteria smaller opening and less bacteria larger opening
- o Single (vorticella) vs colonial (epistylis) does not mean one is better than other, they are all individual species and grow based on the environment

**PROTOZOA – SUCTORIA**

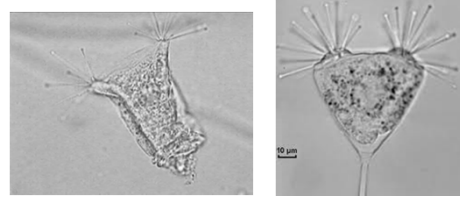

TDEC - Fleming Training Center

- o These are the true vampires of the wastewater world
- o Tentacles may recoil in presence of increased ammonia
- o Some will have a stalk and others may not

62

**FUNGI AND ALGAE**

- o Fungi
  - Soil organisms
  - Degrade dead organic matter (saprophytic)

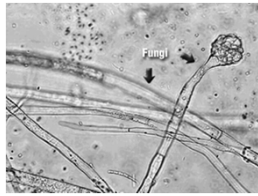

- o Algae
  - Photosynthetic
  - Eutrophication can cause algal blooms in receiving streams
  - Key in operation of wastewater ponds: produce oxygen needed by bacteria
  - Nuisance in clarifiers, basins, etc.

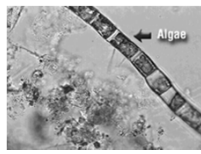

**METAZOA**

- o Multi-cellular animals
- o Multicellular
- o Slower growing
- o Typically larger than protozoa
- o Sexual and asexual reproduction
- o Heterotrophic
- o All are motile
  - Unless there has been an upset to the plant

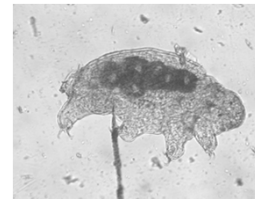

TDEC - Fleming Training Center

- o Examples:
  - Rotifer
  - Water Mite
  - Water Bear
  - Nematodes
  - Ostracods

**METAZOA – ROTIFER**

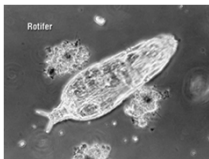

- o Simple multi-celled organisms
- o Need aerobic environment
- o Consume solid food including bacteria
- o In lagoons, they eat lots of algae
- o Means happy, healthy population

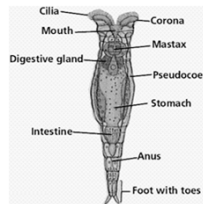

TDEC - Fleming Training Center

- o Over 80% are female
- o Longer Sludge age
- o Low BOD, Sufficient D.O.
- o Some move like snails others resemble free-swimming ciliates

**METAZOA – WATER BEAR (TARDIGRADE)**

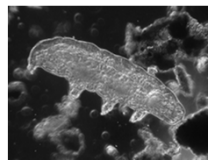

- o Old sludge organism
- o Feeds on smaller protozoa
- o Does not like ammonia
  - Not found in presence of ammonia above 5ppm
- o Extremely aerobic



TDEC - Fleming Training Center

- o 8 legs- with 2 claws on each for holding
  - Prefer rotifers as a food source
- o Typically not seen in industrial waste treatment systems
- o NASA-sent to space

### METAZOA – NEMATODE

- Multicellular organisms
- Diseases (tapeworms, roundworms)
- Beneficial in trickling filters (increase air penetration in biofilm and help in sloughing)

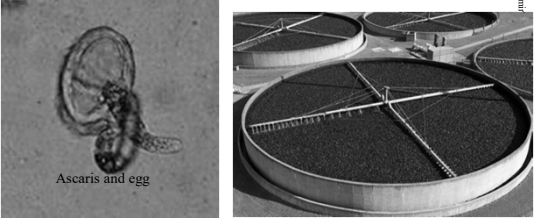

Ascaris and egg

TDEC - Fleming Training Center

### METAZOA – NEMATODE

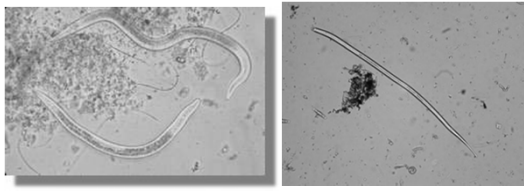

- Aquatic earthworms
- Fast moving
- The poke around the floc
- Older sludge organisms that reproduce slowly

### METAZOA – BRISTLE WORM

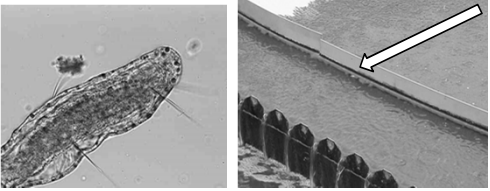

- Aquatic earthworm
- They eat bacteria and protozoa.
- They are relative active. They have red spot that are not visible here but can turn biomass red colored.
- They have the capacity to make your biomass disappear.

TDEC - Fleming Training Center

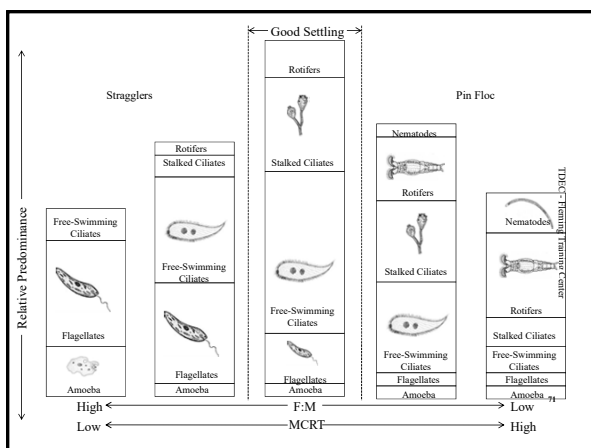
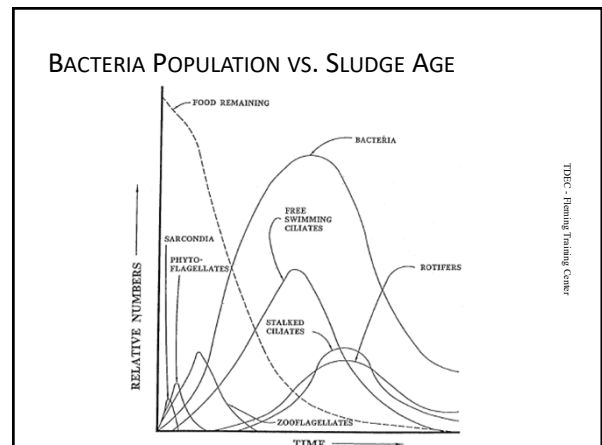

### MICROORGANISMS PREDOMINANCE

- If conventional plant and you start to see more rotifers and less free-swimming ciliates, you need to increase wasting to make old sludge go away
- If extended aeration plant and you have pin floc and nematodes, you are holding your sludge too long.

TDEC - Fleming Training Center

### OXYGEN UPTAKE RATE

- Rate at which microorganisms use oxygen
  - How fast the biomass or bugs are eating, growing and reproducing or more scientifically, metabolizing the available substrate
  - Indicator of toxicity
  - Indicator of food abundance or ease of metabolism
- OUR varies with solids concentration
- SOUR accounts for solids variation/volatile portion
  - Commonly called Respiration Rate

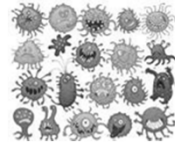

### OUR AND SOUR

- If the standard tests such as DO, pH, temperature, odor and appearance show differences from the normal, the effect of those differences to the biomass maybe indicated by an OUR or SOUR test.
- Changes could be due to industrial discharges both intentional and unintentional, illegal discharges to the collection system from pumpers to terrorist.



TDEC - Fleming Training Center

### SOUR VALUES

- **SOUR >20mgO<sub>2</sub>/hr/gm MLVSS**
  - Logarithmic growth, Flagellates, dispersed flock
  - Settling Slow SSV<sub>5</sub>>750cc/L
- **SOUR 12-20mgO<sub>2</sub>/hr/gm MLVSS**
  - Declining growth, Ciliates, Flocks forming
  - Settling normal SSV<sub>5</sub>=600-750 cc/L
- **Sour <12mgO<sub>2</sub>/hr/gm MLVSS**
  - Endogenous Respiration, Rotifers and higher life
  - Pin Flock
  - Settling Fast, SSV<sub>5</sub><600cc/L
- Remember the growth graph

TDEC - Fleming Training Center

### SOUR VALUES

- By conducting background tests on your aeration basin, operators will generate historic data that will show what a “normal” SOUR level is for your facility
  - If a test value dramatically changes from normal, suspect a change in the influent or biomass characteristics

TDEC - Fleming Training Center

### SOUR TEST METHOD – SM 2710

- In order to have results that reflect true aeration basin conditions analyze samples without delay.
- If DO levels in the sample are low (SM states  $\leq 2.0$  mg/L), manually aerate the sample.
- DO values in the sample at the end of the test should be above 1.0 mg/L, a number which is also used in BOD test rules



### SOUR – 40 CFR 503

- One of the Class B Vector Attraction Reduction options for Biosolids
- 40CFR-40-15-.04 (4)(b)(4)
  - “The specific oxygen uptake rate (SOUR) for biosolids treated in an aerobic process shall be equal to or less than 1.5 milligrams of oxygen per hour per gram of total solids (dry weight basis) at a temperature of 20°Celsius.”

TDEC - Fleming Training Center

78

### LONG TERM PROCESS CONTROL



- o F:M
- o Food to Microorganism Ratio
- lbs. of Raw BOD  
lbs. of MLVSS
- o Even bugs want an adequate diet
- o Always at least 5 days late

TDEC - Fleming Training Center

### PROCESS CONTROL IN SUMMARY



- o Human senses
  - Visual appearance, odors
- o Process tests
  - Flow, D.O., pH, temp., alkalinity, ORP, turbidity
  - Settlemeter, Sludge judge
  - MLSS, MLVSS
  - Centrifuge spins
  - Microscopic evaluation
  - Oxygen Uptake Rate, Specific Oxygen Uptake Rate

TDEC - Fleming Training Center

### PROCESS CONTROL

- o Choose a method that works for you.
- o Collect the Data.
  - Data is the voice of the process.
- o Use the Data!
- o Make decisions based on the data!
- o Graph the Data!
  - Picture of the numbers, picture of the process.

TDEC - Fleming Training Center

### PROCESS CONTROL

- o Find a method that works for you
- o Use it!
  - Meet your Permit
  - Do better than your Permit!
  - Operate at a lower cost
  - Become a better operator



Settleable Solids (60 minutes Settleometer Test)					
Time Interval	Ditch 1			Ditch 2	
	5	30	60	5	30
Sat. Solids mL/L	600	340	295	975	710

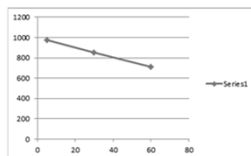
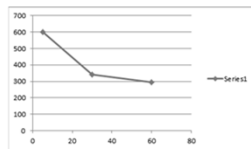

What do the two graphs tell you about the settleability of the mixed liquor samples from two different ditches?

TDEC - Fleming Training Center

- What most operators hope to see is the perfect settling: not too fast, not too slow.
1. It should form a large floc particle that settles well and also traps fine particles that make up the turbidity around the floc.
  2. The biomass should produce a clear liquid above the settling solids — the liquid that will become the plant effluent. This biomass settles just right!

At the 30-minute mark, the biomass has settled and compacted, hopefully leaving clear supernatant above the blanket of solids. Additional settling time (the next half-hour) might show some additional compaction of the biomass or clarification of the supernatant. This is also important to note.

**Ditch 1**  
You will notice that when the biomass is settling well, the 30-minute reading will be about half of the five-minute reading. In this example, the five-minute reading is 600, the 30-minute reading will be about 350.

[http://www.tpmag.com/editorial/2015/05/back\\_to\\_basics\\_what\\_is\\_the\\_settleability\\_test](http://www.tpmag.com/editorial/2015/05/back_to_basics_what_is_the_settleability_test)

ANY QUESTIONS?



TDEC - Fleming Training Center

85



## Process Control Testing – Review Questions

### Laboratory portion:

1. For the settleability test, what apparatus did we use? Why was it a better choice than a graduated cylinder?
2. The settleability test procedure requires that the sample be gently poured into the container with as little agitation as possible. Why is that necessary?
3. In the settleability test, when would you need to dilute the sample? And what type of water would you use to dilute it with?
4. The MLSS test procedure is the same as which NPDES monitoring test?
5. The MLVSS test is run the same as MLSS, but with an added step at the end. If we had wanted to determine the MLVSS portion of our sample, what would we have done next after completing the MLSS test?
6. We performed a calculation that used our results from the 30 minute settleability test ( $SSV_{30}$ ) and the MLSS test. What is the name of that calculation and what does the number tell us?
7. The OUR test should ideally be conducted immediately after sample collection. DO levels that are low (according to Standard Methods, low DO is  $<2$  at the start of the test) require aeration. When we conducted the OUR test, the beginning DO level was very low, so we had to aerate it. How do you aerate these samples in the lab?

### Classroom portion:

8. How are process control tests different from NPDES monitoring tests?
9. List 5 process control tests.

10. List 5 NPDES monitoring tests.
11. The settleability test determines what? This test tells you what 2 things about your biomass?
12. How often are sludge volumes recorded during the settleability test?
13. What test gives a more precise sludge age calculation?
14. What measurements are required in order to calculate the Mean Cell Residence Time?
15. List 3 examples of protozoans found in activated sludge.
16. List 3 examples of metazoans found in activated sludge.
17. Which activated sludge organisms are traditionally seen as a sign of good settling sludge and efficient plant operations?
18. Are filamentous bacteria helpful or harmful in the aeration basin?
19. What does OUR stand for and what information does that test provide?
20. What does SOUR stand for? How is SOUR related to OUR?
21. Ashing and Pin Floc indicate what?
22. Straggler Floc indicates what?

## Settleability Bench Sheet

Date \_\_\_\_\_

Time \_\_\_\_\_

Analyst \_\_\_\_\_

Aeration Tank Concentration (ATC), % = \_\_\_\_\_

Time	SSV, mL/L	SSC, %
0		
5		
10		
15		
20		
25		
30		
40		
50		
60		

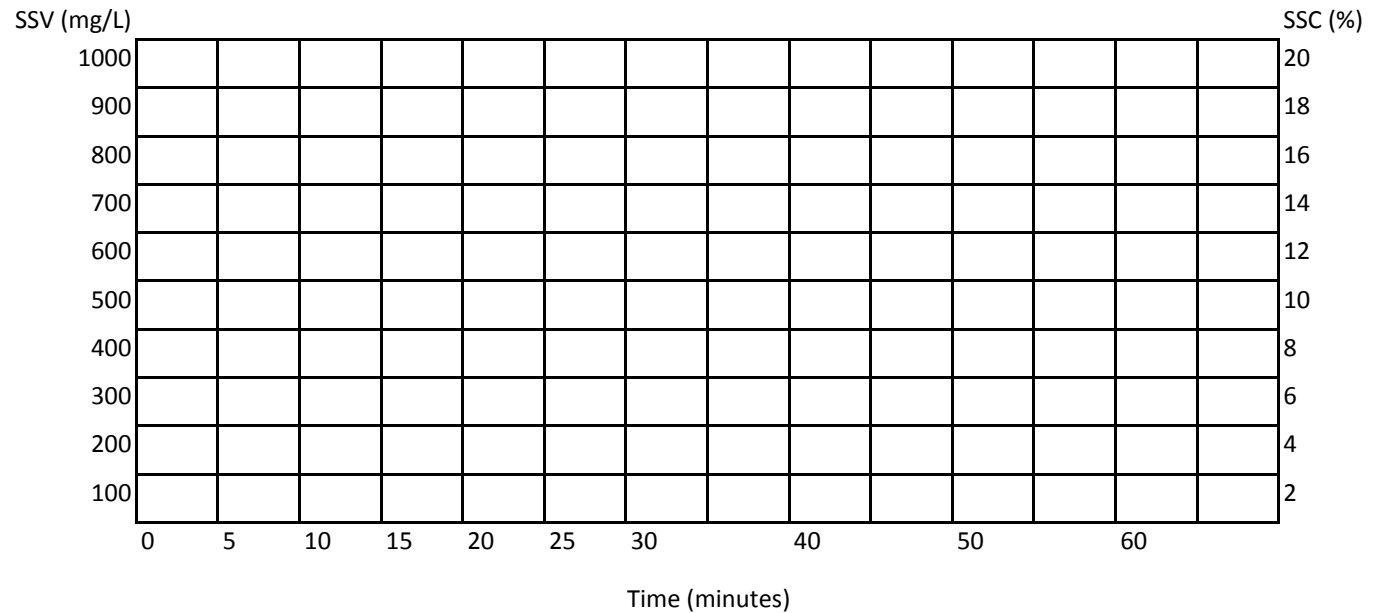

$$SSC = \frac{(1000)(ATC)}{SSV}$$

Observations:

Floc

- flocculant
- dispersed

Interface

- well defined
- ragged

Supernatant

- clear
- turbid
- pin floc
- straggler floc

Rise Time, hrs: \_\_\_\_\_

Comments: \_\_\_\_\_

\_\_\_\_\_

\_\_\_\_\_



# Solids, Non-filterable Suspended, Total and Volatile

USEPA Gravimetric Method<sup>1, 2</sup>

Method 8158 and Method 8164

**Scope and application:** For water and wastewater.

<sup>1</sup> USEPA accepted.

<sup>2</sup> Adapted from *Standard Methods for the Examination of Water and Wastewater*, Section 2540B.



## Test preparation

### Before starting

Analyze samples as soon as possible for best results.

For the best accuracy, use as much filtered sample as possible (step 11). Samples that contain more than 15 mg of solids will clog the fiber filter disc. Adjust the correct volume of the water sample to get accurate results. Some completed tests will show if adjustments are necessary.

Always use tweezers with fiber filter discs. Moisture from fingers can add moisture to the fiber filter disc and cause a weighing error.

For Volatile Non-filterable Solids (or Residue) (VNR) preheat the muffle furnace below the recommended temperature. Do not put the watch glass directly in a 550 °C (1022 °F) muffle furnace because it can break. Put the watch glass in a 100 °C (212 °F) preheated muffle furnace and then increase the temperature to 550 °C (1022 °F) for 15 minutes.

The Total Non-filterable Solids (or Residue) (TNR) are the same as the Total Suspended Solids (TSS).

### Items to collect

Description	Quantity
Analytical balance	1
Cylinder, graduated, 100 mL	1
Desiccator with desiccant	1
Drying oven	1
Filter flask	1
Filter holder	1
Filter, 47-mm	1
Furnace, muffle	1
Rubber policeman for 3/16 in. rod (user-supplied)	1
Tongs	1
Tweezers	1
Watch glass	1
Watch glass	1
Water, deionized	varies

Refer to [Consumables and replacement items](#) on page 5 for order information.

## Sample collection and storage

- Collect samples in clean glass or plastic bottles.
- To preserve samples for later analysis, keep the samples at or below 6 °C (43 °F) for up to 7 days.
- Let the sample temperature increase to room temperature before analysis.

## Test procedure—Total Non-filterable Solids, Method 8158

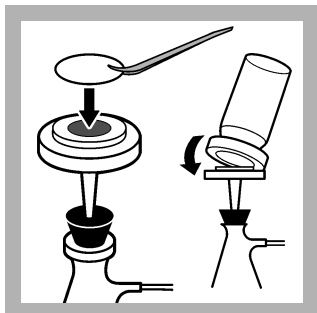

1. Use tweezers to put a fiber filter disc in the filter holder.

Put the filter holder assembly in the filtering flask.

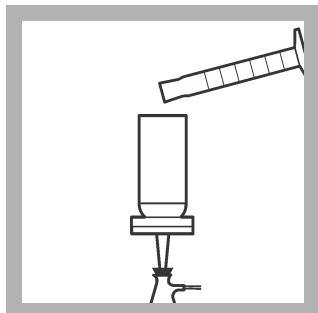

2. Use a graduated cylinder to add 100 mL of deionized water to the filtering flask.

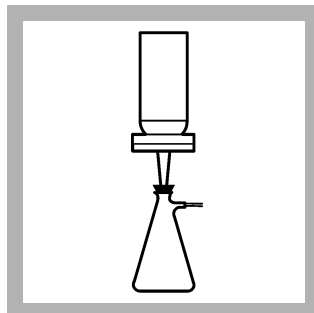

3. Apply vacuum to the flask until all of the water is pulled through the filter.

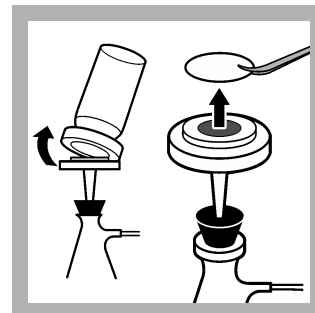

4. Slowly release the vacuum from the filtering system. Remove the fiber filter disc from the filter holder.

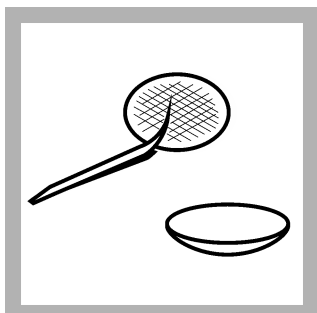

5. Put the fiber filter disc in a watch glass.

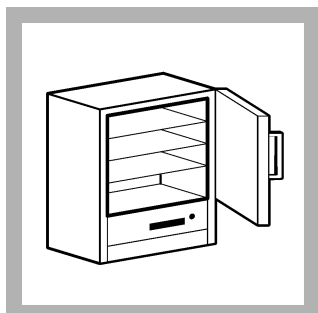

6. Put the watch glass with the fiber filter disc in a preheated drying oven at 103–105 °C (217–221 °F) for 1 hour.

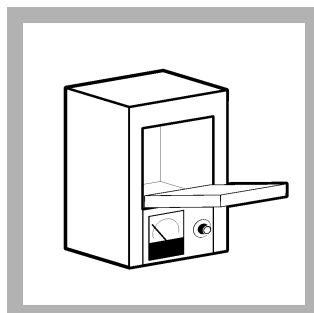

7. If Volatile Non-filterable Solids are also measured, use tongs to put the watch glass with the fiber filter disc into a preheated muffle furnace at 550 °C (1022 °F) for 15 minutes. Discard this step if Volatile Non-filterable Solids are not measured.

**Note:** Do not put the watch glass directly in a 550 °C (1022 °F) muffle furnace because it can break. Put the watch glass in a 100 °C (212 °F) preheated muffle furnace and then increase the temperature to 550 °C (1022 °F) for 15 minutes.



8. Use metal tongs to remove the watch glass with the fiber filter disc from the drying oven or muffle furnace and put in a desiccator. Immediately cover the desiccator. Do not seal the desiccator until the watch glass temperature has decreased a little, because pressure from the hot air inside can push the cover off.

Let the fiber filter disc and watch glass temperature decrease to room temperature.

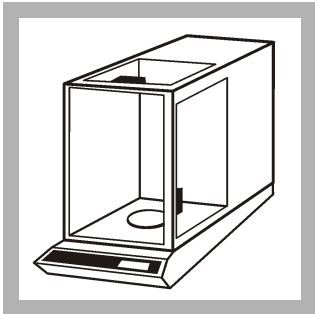

**9.** Remove the watch glass with the fiber filter disc from the desiccator and put it adjacent to the analytical balance.

Use tweezers to remove the fiber filter disc from the watch glass. Weigh the fiber filter disc to the nearest 0.1 mg (0.0001 g). Record this mg value as B.

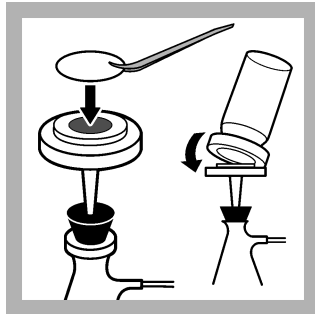

**10.** Put the fiber filter disc in the filter holder/filtering system again. Use deionized water to bond the fiber filter disc to the filter holder.

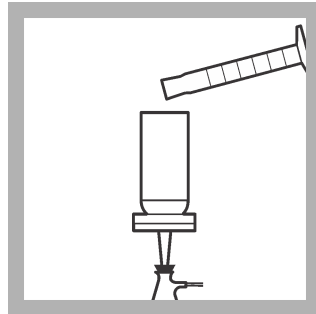

**11.** Use a graduated cylinder to add 100 mL (or more, if the solids content is low) of well-mixed, representative water sample.

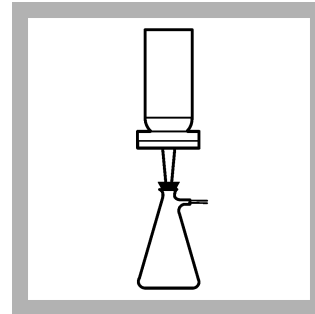

**12.** Apply vacuum to the flask until all of the water is pulled through the filter.

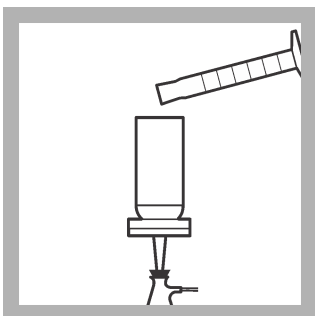

**13.** Add three different 10-mL aliquots of deionized water. Wait until each aliquot is pulled through the filter before the next one is added.

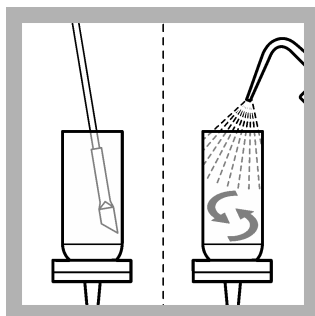

**14.** Move all of the remaining material that stays on the sides or bottom lip of the filter holder on the filter.

Use a rubber policeman on the end of a stirring rod as a scraper to remove the solids.

Use small amounts of deionized water to pull the solids down on the fiber filter disc.

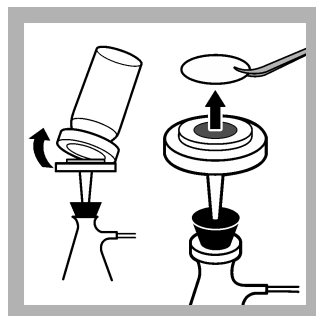

**15.** Slowly release the vacuum from the filtering system. Remove the fiber filter disc from the filter holder.

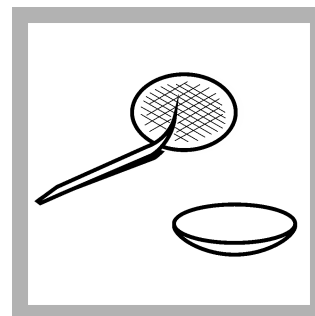

**16.** Put the fiber filter disc in a watch glass.

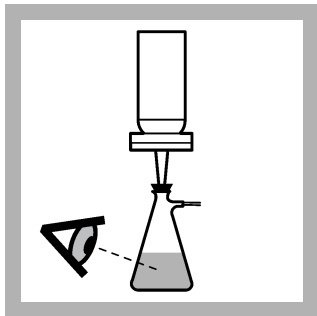

**17.** Examine the filtrate (filtered water in flask) to make sure that the solids are caught on the fiber filter disc.

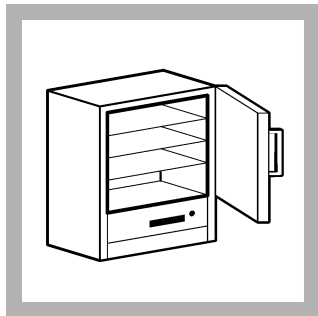

**18.** Put the watch glass with the fiber filter disc in a preheated drying oven at 103–105 °C (217–221 °F) for 1 hour.



**19.** Use metal tongs to remove the watch glass with the fiber filter disc from the drying oven or muffle furnace and put in a desiccator. Immediately cover the desiccator. Do not seal the desiccator until the watch glass temperature has decreased a little, because pressure from the hot air inside can push the cover off.

Let the fiber filter disc and watch glass temperature decrease to room temperature.

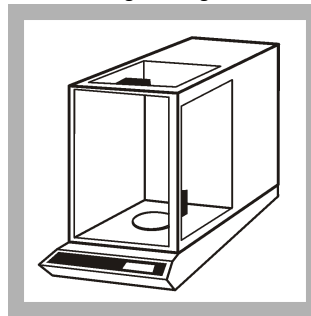

**20.** Remove the watch glass with the fiber filter disc from the desiccator and put it adjacent to the analytical balance.

Use tweezers to remove the fiber filter disc from the watch glass. Weigh the fiber filter disc to the nearest 0.1 mg (0.0001 g). Record this mg value as A.

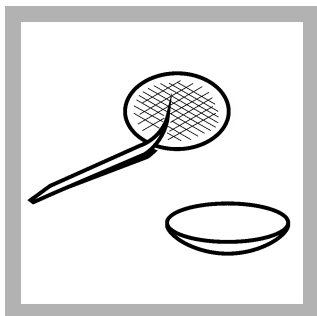

**21.** Put the fiber filter disc back on the watch glass to measure Volatile Nonfilterable Residue. If not, discard the disc. If Volatile Nonfilterable Residue is measured, make sure to not lose any of the suspended matter on the disc.

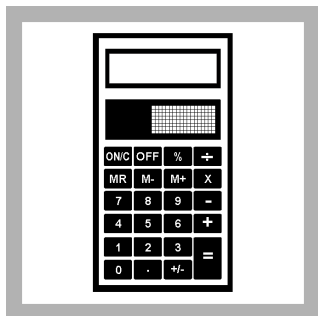

**22.** Calculate the test results:  
 $(A - B) \div L \text{ sample} = \text{mg/L}$   
 Total Non-filterable Residue (TNR)

Where:  
 A = Weight (mg)<sup>1</sup> of fiber filter disc with solids  
 B = Weight (mg) of empty fiber filter disc

Example:

A = 95.5 mg

B = 81.5 mg

Volume of sample = 0.100 L

$(95.5 \text{ mg} - 81.5 \text{ mg}) \div 0.100$   
 = 140 mg/L TNR

<sup>1</sup> Weight in mg = grams  $\times$  1000



## Test procedure—Volatile Non-filterable Solids, Method 8164

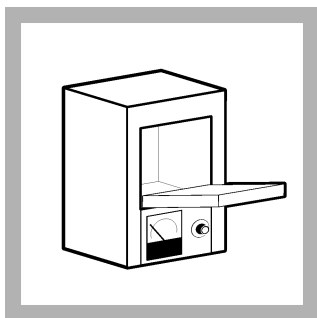

1. Put the watch glass and filter disc from the Total Non-filterable Solids procedure (step 21) in a preheated muffle furnace at 550 °C (1022 °F) for 15 minutes.

**Note:** Do not put the watch glass directly in a 550 °C (1022 °F) muffle furnace because it can break. Put the watch glass in a 100 °C (212 °F) preheated muffle furnace and then increase the temperature to 550 °C (1022 °F) for 15 minutes.



2. Use metal tongs to remove the watch glass with the fiber filter disc from the drying oven or muffle furnace and put in a desiccator. Immediately cover the desiccator. Do not seal the desiccator until the watch glass temperature has decreased a little, because pressure from the hot air inside can push the cover off.

Let the fiber filter disc and watch glass temperature decrease to room temperature.

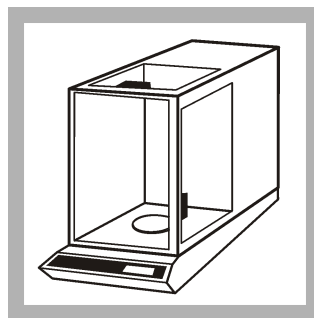

3. Remove the watch glass with the fiber filter disc from the desiccator and put it adjacent to the analytical balance.

Use tweezers to remove the fiber filter disc from the watch glass. Weigh the fiber filter disc to the nearest 0.1 mg (0.0001 g). Record this mg value as C.

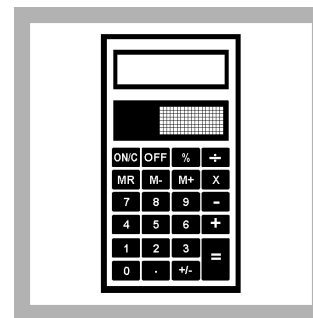

4. Calculate the test results:  $(A - C) \div$  sample volume in L = mg/L Volatile Non-filterable Residue (VNR)

Where:

A = Weight (mg) of fiber filter disc with solids (step 20)

C = Weight (mg) of fiber filter disc with solids

Example:

A = 95.5 mg

C = 91.2 mg

Volume of sample = 0.100 L  
 $(95.5 \text{ mg} - 91.2 \text{ mg}) \div 0.100$   
 = 43 mg/L VNR

### Summary of method

A glass fiber filter disc is used as a filter in a filtering flask. Deionized water is pulled with vacuum through the filter. The fiber filter disc is dried to a constant weight in an oven at 102-105 °C (217–221 °F) to determine the weight of the empty disc. A well-mixed filtered sample is dried in the same fiber filter disc to a constant weight in an oven at 102-105 °C (217–221 °F). The weight difference between the empty disc and the disc with the remaining materials shows the Total Non-filterable Solids. To measure the Volatile Non-filterable Solids, the fiber filter disc is put in a muffle furnace at 550 °C (1022 °F) to remove all of the volatile material. The weight difference between the disc and the disc with remaining materials shows the Volatile Non-filterable Solids.

### Consumables and replacement items

#### Required reagents and apparatus

Description	Quantity/test	Unit	Item no.
Aspirator, vacuum pump	1	each	213100
Balance, analytical, 80 g x 0.1 mg, 100–240 VAC	1	each	2936701
Bottle, wash, 500 mL	1	each	62011
Cylinder, graduated, 100 mL	1	each	50842
Desiccant, indicating Drierite	1	each	2088701
Desiccator, without stopcock	1	each	1428500
Desiccator plate, ceramic	1	each	1428400
Filter discs, glass fiber, 47 mm	1	100/pkg	253000
Filter holder, 47-mm, magnetic base	1	each	1352900

**Required reagents and apparatus (continued)**

Description	Quantity/test	Unit	Item no.
Flask, filtering, glass, 1000 mL	1	each	54653
Furnace, muffle 240 VAC, 50/60 Hz	1	each	1429624
Furnace, muffle, 120 VAC, 50/60 Hz	1	each	1429600
Oven, laboratory, 240 VAC/50 Hz	1	each	1428902
Oven, laboratory, 120 VAC/60 Hz	1	each	1428900
Stopper, rubber, one-hole, number 8	1	6/pkg	211908
Tongs	1	each	56900
Tubing, rubber, 7.9 mm x 2.4 mm	varies	12 ft	56019
Tweezers, plastic	1	each	1428200
Watch glass, 100 mm	1	each	57870
Water, deionized	varies	4 L	27256

**Optional reagents and apparatus**

Description	Unit	Item No.
Ammonium Hydroxide, 58%	500 mL	10649
Sampling bottle with cap, low density polyethylene, 500-mL	12/pkg	2087079
Brush	each	68700
Pump, vacuum, hand-operated	each	1428300
Pump, vacuum, 1.2 CFM, 220 VAC	each	2824801
Pump, vacuum, 1.2 CFM 115 V	each	2824800
Stirring rod, glass	3/pkg	177001



**FOR TECHNICAL ASSISTANCE, PRICE INFORMATION AND ORDERING:**  
 In the U.S.A. – Call toll-free 800-227-4224  
 Outside the U.S.A. – Contact the HACH office or distributor serving you.  
 On the Worldwide Web – [www.hach.com](http://www.hach.com); E-mail – [techhelp@hach.com](mailto:techhelp@hach.com)

**HACH COMPANY**  
 WORLD HEADQUARTERS  
 Telephone: (970) 669-3050  
 FAX: (970) 669-2932

# Appendix

# Blank Data Forms

# Observation & Field Test Data Sheet

Day \_\_\_\_\_ Date \_\_\_\_\_ Time \_\_\_\_\_ Weather \_\_\_\_\_ Operator \_\_\_\_\_

24-hour flow readings: Influent \_\_\_\_\_ Return \_\_\_\_\_ Waste \_\_\_\_\_

## Aerator Observations and Measurements

	Aerator #1	Aerator #2	Aerator #3	Aerator #4
Flow to aerator				
Foam: amount				
	color			
Mixed color				
Liquor: odor				
	mixing			
D.O./Temp.	Station #1			
	Station #2			
	Station #3			
	Station #4			
Remarks:				

## Secondary Clarifier Observations & Measurements

RSF, gpm	Clarifier #1	Clarifier #2	Clarifier #3	Clarifier #4
Surface Appearance				
BLT, ft.				
Clarity, in.				
Remarks:				

# Settler & Solids Test Data & Calculation Sheet

Day \_\_\_\_\_  
 Date \_\_\_\_\_  
 Time \_\_\_\_\_  
 Operator \_\_\_\_\_

SST, min.	SSV, cc/L	SSC, %	Comments	Observations
0	1000		SSC @ 0 min - ATC	<p>(a) During the first 5-10 minutes</p> <ul style="list-style-type: none"> <li>• How does the floc look?  <input type="checkbox"/> granular   <input type="checkbox"/> compact   <input type="checkbox"/> fluffy   <input type="checkbox"/> feathery</li> <li>• What is the size of the agglomerating flocs?  <input type="checkbox"/> large   <input type="checkbox"/> small</li> <li>• How are the sludge particles settling?  <input type="checkbox"/> as a blanket   <input type="checkbox"/> as individual particles</li> <li>• How does the supernatant look?  <input type="checkbox"/> clear   <input type="checkbox"/> cloudy</li> <li>• Is there straggler floc in the supernatant?  <input type="checkbox"/> yes   <input type="checkbox"/> no</li> </ul> <p style="margin-left: 40px;">If yes, how much?   <input type="checkbox"/> lots   <input type="checkbox"/> not much</p> <p>(b) At the end of 30 minutes how does the sludge blanket look?  <input type="checkbox"/> crisp with sharp edges   <input type="checkbox"/> feather-edged, fluffy  <input type="checkbox"/> like a sponge (holes)   <input type="checkbox"/> homogeneous</p> <p>(c) Rise time: _____ hours   _____ minutes</p>
5				
10			Fill in (a)	
15				
20				
25				
30			Fill in (b)	
40				
50				
60				
90				
120			SSV & SSC readings and calculations at 90 to 240 minutes are required only when sludge settles slowly.	
150				
180				
240				

$$\text{SSC} = \frac{\text{ATC} \times 1000}{\text{SSV}}$$

**Solids Concentrations:**

AB#1 _____	CL#1 _____	RS#1 _____
AB#2 _____	CL#2 _____	RS#2 _____
AB#3 _____	CL#3 _____	RS#3 _____
AB#4 _____	CL#4 _____	RS#4 _____

# Settlometer Graph

Day \_\_\_\_\_ Date \_\_\_\_\_ Time \_\_\_\_\_ Sample Temp. \_\_\_\_\_ F Operator \_\_\_\_\_

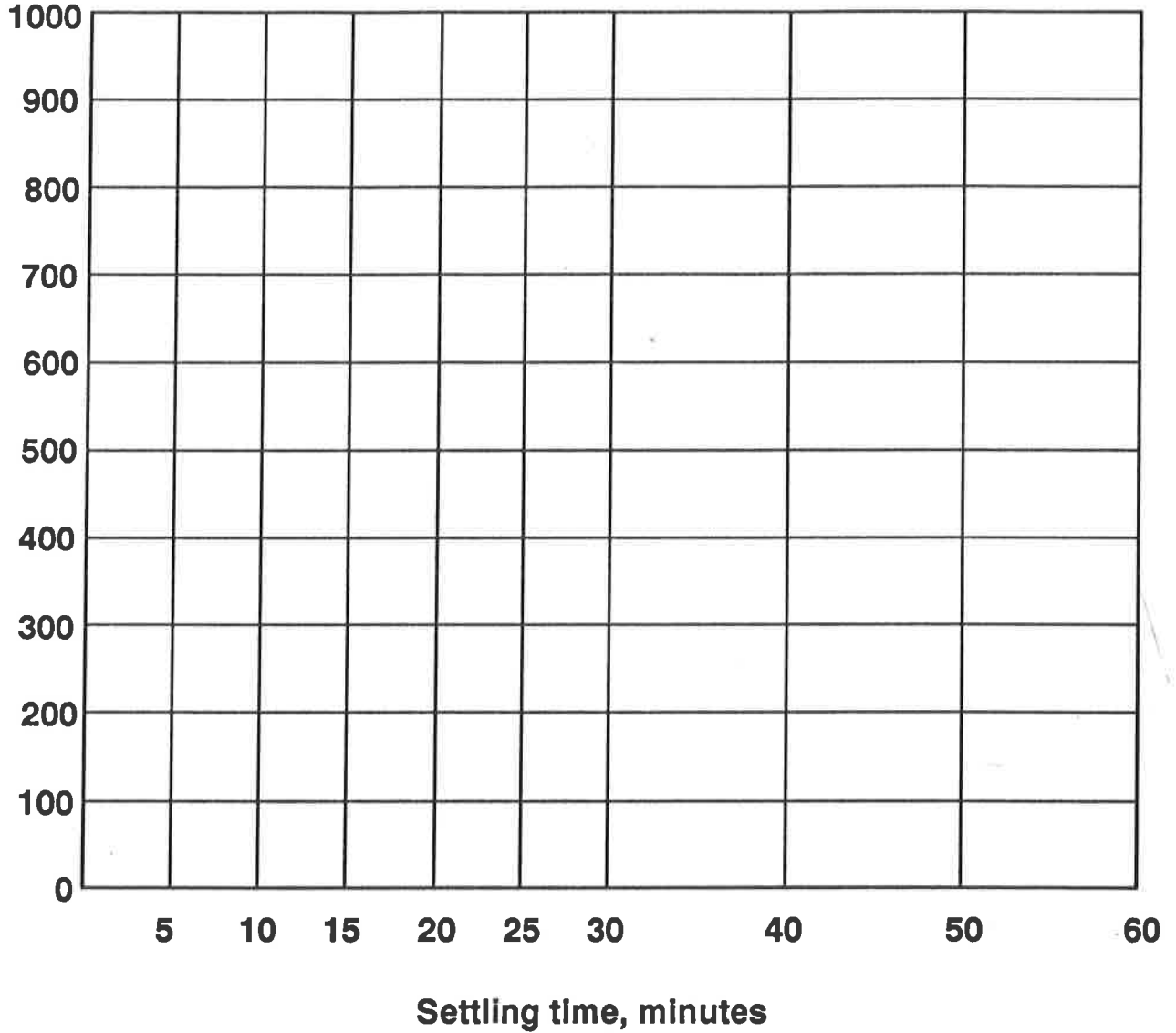

# Sludge Wasting Worksheet

(Using TSS, mg/L and Pounds)

## 1. Calculation of Solids In Aeration Basins (AB), pounds

	TSS, mg/L	X	AB Vol., MG	X	8.34	=	lbs of solids	
Basin #1 :	_____	X	_____	X	8.34	=	_____	
Basin #2:	_____	X	_____	X	8.34	=	_____	
Basin #3 :	_____	X	_____	X	8.34	=	_____	
Basin #4:	_____	X	_____	X	8.34	=	_____	
<b>Total Aeration Solids, lbs</b>							=	_____

## 2. Calculation of Clarifier Solids, pounds

	CSC, mg/L	X	Clar. vol., MG	X	8.34	=	lbs of solids	
Clarifier #1	_____	X	_____	X	8.34	=	_____	
Clarifier #2	_____	X	_____	X	8.34	=	_____	
Clarifier #3	_____	X	_____	X	8.34	=	_____	
Clarifier #4	_____	X	_____	X	8.34	=	_____	
<b>Total Clarifier Solids, lbs</b>							=	_____

## 3. Calculation of Total Solids Inventory (TSI) In pounds

$$\frac{\text{Total AB lbs}}{\text{Total AB lbs}} + \frac{\text{Total Clar. lbs}}{\text{Total Clar. lbs}} = \frac{\text{TSI, lbs}}{\text{TSI, lbs}}$$

## 4. Calculation of Solids Lost In Effluent, lbs/day

$$\frac{\text{Effluent TSS, mg/L}}{\text{Effluent TSS, mg/L}} \times \frac{\text{Effluent Flow, MGD}}{\text{Effluent Flow, MGD}} \times 8.34 = \frac{\text{Effluent Solids, lbs/day}}{\text{Effluent Solids, lbs/day}}$$

## 5. Calculation of Waste Sludge Requirements, lbs/day

$$\frac{\text{Solids to Waste, lbs/day}}{\text{Solids to Waste, lbs/day}} = \frac{\text{TSI, lbs}}{\text{Target MCRT}} \div \frac{\text{Eff. TSS, lbs, day}}{\text{Eff. TSS, lbs, day}} = \frac{\text{lbs/day}}{\text{lbs/day}}$$

## 6. Calculation of Waste Sludge Flow, gpd (WSF, gpd)

$$\text{WSF, gpd} = \frac{\text{Solids to waste, lbs/day} \times 1,000,000}{\text{WAS TSS, mg/L} \times 8.34} = \frac{\text{X } 1,000,000}{\text{X } 8.34} = \text{(WSF, gpd)}$$

CSC	=	Clarifier Sludge Concentration, mg/L (concentration of clarifier core sample)
MG	=	Millions of gallons
TSS	=	Total Suspended Solids, mg/L
Target MCRT	=	Desired sludge age (MCRT) in days
WAS	=	Waste Activated Sludge







# Microscopy Laboratory Data Sheet

Sample location: \_\_\_\_\_ Day \_\_\_\_\_

Analyst: \_\_\_\_\_ Date \_\_\_\_\_

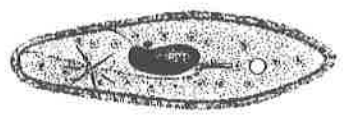
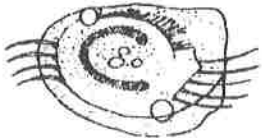
Time \_\_\_\_\_

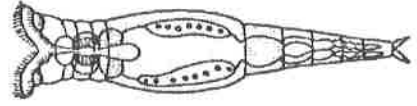
Temp \_\_\_\_\_

Microorganism Group	View #1	View #2	View #3
<b>Amoeboids</b> 			
<b>Flagellates</b> 			
<b>Free-swimming ciliates</b> 			
<b>Crawling ciliates</b> 			
<b>Stalked ciliates</b> 			
<b>Rotifers</b> 			
<b>Worms</b> 			

Relative Predominance: 1) \_\_\_\_\_

2) \_\_\_\_\_

3) \_\_\_\_\_



## Specific Oxygen Uptake Rates

Specific Oxygen Uptake Rate (SOUR) could be the most valuable yet underutilized test available to operators of activated sludge processes. The procedure will tell you how fast the biomass or bugs are eating, growing and reproducing or more scientifically, metabolizing the available substrate. Oxygen uptake rate (OUR) and Specific oxygen uptake rate tests are a way to quickly monitor the toxicity or food value of sewage and wastewater to the living and breathing biomass within a wastewater treatment plant. These tests which show the rate at which oxygen is used by the bugs in the activated sludge system can indicate if the bugs are eating the food or BOD at a normal rate or a faster or slower rate than normal or not at all. From this information some conclusions can be made regarding the characteristics of the raw wastewater or the conditions of the biomass.

### Why

Operators may use the test to check the effects of raw water, which for some reason appears different. If the standard tests such as DO, pH, temperature, odor, and appearance show differences from the normal, the effect of those differences to the biomass may be indicated by a OUR or SOUR test. Changes could be due to industrial discharges both intentional and unintentional, illegal discharges to the collection system from pumpers or even terrorist. One part of a terrorist vulnerability assessment is having adequate raw water monitoring procedure. OUR and SOUR testing of raw sewage flows can enhance the standard permit required influent monitoring. Another use of the SOUR test is to supplement other process control tests when they give mixed signals.

### Strategy

In order to have useful results operators need a monitoring strategy. The OUR test will give you a numerical rate at which oxygen is taken up by the biomass. The results are expressed as milligrams of oxygen used per liter of mixed liquor per hour (mg O<sub>2</sub>/L/hr). The SOUR test gives results in milligrams of oxygen used per hour per gram of mixed liquor volatile suspended solids (mg O<sub>2</sub>/hr/g MLVSS). Continuing through the extra steps to calculate the SOUR instead of the OUR test removes the variation in uptake rate due to different amounts of mixed liquor (MLSS) and differing levels of volatile material in the mixed liquor. It is obvious that higher MLSS levels will use more oxygen per hour than lower MLSS levels and if volatile levels are higher the same holds true. In order to have results, which reflect the changes in metabolism and not differing MLSS levels the SOUR test is preferred. Results may also be adjusted to changes in the basin temperature; so another source of process variation is removed. Attached is a temperature adjustment method. This is actually the method used when the SOUR test is performed to demonstrate biosolids stability. Currently (Dec 2003) my best information is that this is the correct way to correct temperature for activated sludge.

## SOUR Test Values

Chart 1 shows commonly accepted SOUR values at different biomass ages. By conducting background tests on your aeration basin operators will generate historic data that will show what a normal SOUR level is for the facility. Most extended aeration plants where I have data, show SOUR values less than  $6\text{mgO}_2/\text{hr/g MLVSS}$ . Because stormwater flows affect plants so significantly, readings during rainfall events may be summarized separately. Segregating data during stormy weather will remove another source of test variation from the background data. Once you have conducted several SOUR tests at normal flows you will begin to understand what is normal for the facility. If a test value dramatically changes from normal suspect a change in the influent or biomass characteristics. An excellent method of documenting changes in an ongoing test procedure like the SOUR test is to construct a control chart. Control charts are designed to identify normal and abnormal variation in a process (Wheeler & Chambers).

Chart 1

### SOUR $>20\text{mgO}_2/\text{hr/gm MLVSS}$

- Logarithmic growth, Flagellates, dispersed flock
- Settling Slow  $SSV_5 > 750\text{cc/L}$

### SOUR $12\text{-}20\text{mgO}_2/\text{hr/gm MLVSS}$

- Declining growth, Ciliates, Flocks forming
- Settling normal  $SSV_5 = 600\text{-}750\text{ cc/L}$

### Sour $<12\text{mgO}_2/\text{hr/gm MLVSS}$

- Endogenous Respiration, Rotifers and higher life
- Pin Flock
- Settling Fast,  $SSV_5 < 600\text{cc/L}$

## Test Method

Standard Method 2710; Oxygen-Consumption Rate, details the test procedure. In order to have results that reflect true aeration basin conditions analyze samples without delay. If dissolved oxygen levels in the sample are low (S.M. states  $<2.0\text{mg/L}$ ) manually aerate the sample. DO values in the sample at the end of the test should be above  $1.0\text{ mg/L}$ , a number which is also used in BOD test rules. An excellent SOUR worksheet is included in the Water Environment Federation's Probe Series book, Basic Activated Sludge Process Control. On this sheet SOUR is referred to as Respiration Rate (RR). The worksheet is set up for two ten minute tests, SM specifies 15 minute a test. The ten minute test seems to be more of an industry standard with activated sludge with results reported in grams of MLVSS, but for biosolids testing for 503 compliance always conduct the test for 15 minutes and report in units of grams of Total Solids.

## Temperature Adjustment

SOUR is determined at the aeration basins ambient temperature and then adjusted as follows.

$$\text{SOUR@20EC} = \text{SOUR @ Ambient Temp.} * A^{(20-\text{Ambient temp.})}$$

Where A = 1.05 above 20E

= 1.07 below 20E

These factors are good between 10E C and 30E C

Simplified

$$\text{SOUR @20E C} = \text{SOUR @ Ambient Temp.} * \text{Correction Factor}$$

$$\text{Correction} = A^{(20-\text{Ambient Temp})}$$

TempE C	Correction Factor
10	1.97
11	1.84
12	1.72
13	1.60
14	1.50
15	1.40
16	1.31
17	1.22
18	1.14
19	1.07
20	1.00
21	0.95
22	0.90
23	0.86
24	0.82
25	0.78
26	0.75
27	0.71
28	0.68
29	0.64
30	0.61

## Respiration Rate (SOUR) Worksheet/Graph

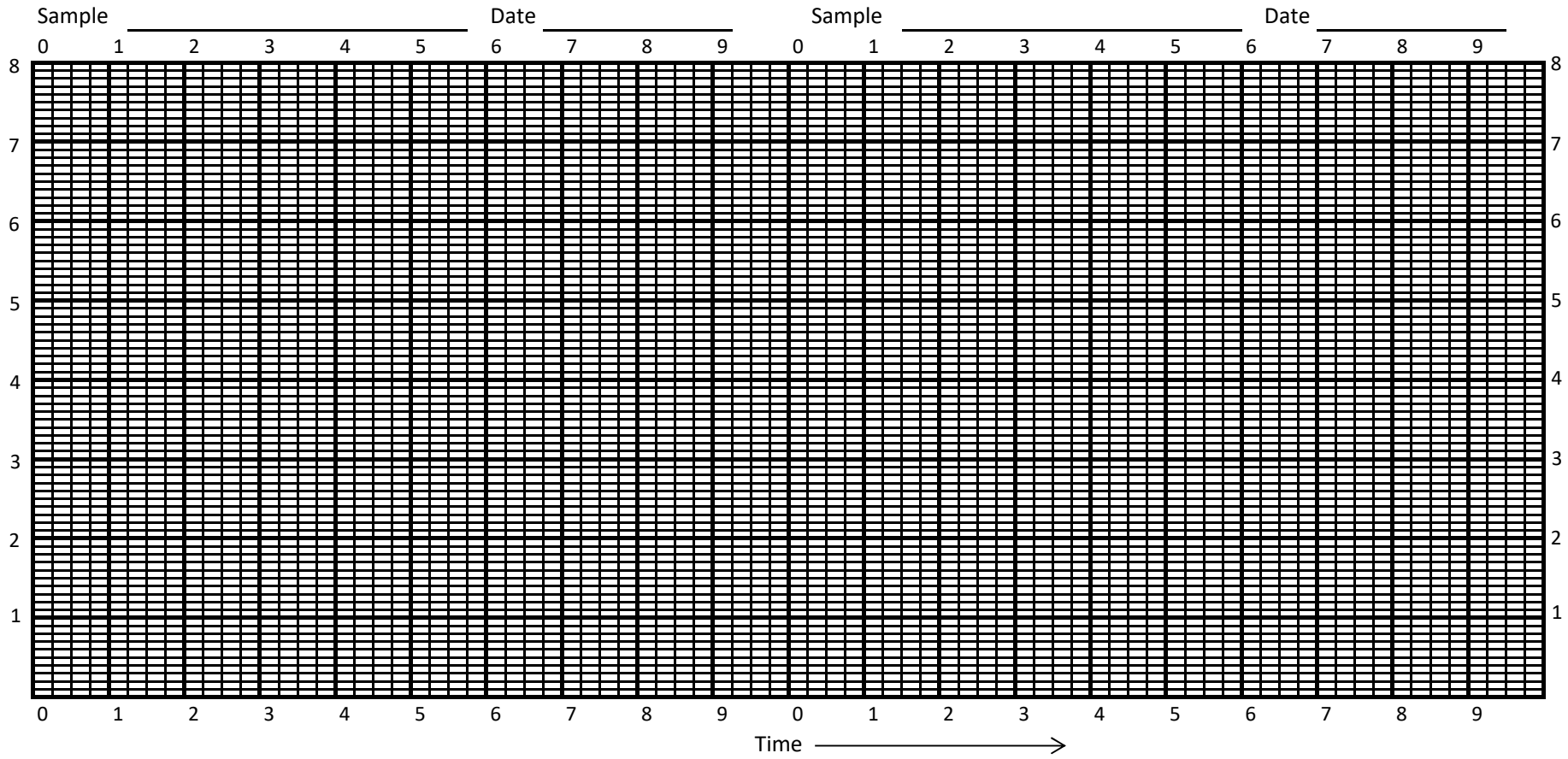

Slope Calculations	Slope Calculations
$\frac{\text{mg/L O}_2}{\text{min}} \times 60 = \text{mg O}_2/\text{L-hr (OUR)}$	$\frac{\text{mg/L O}_2}{\text{min}} \times 60 = \text{mg O}_2/\text{L-hr (OUR)}$
$\frac{\text{mg/L-hr OUR}}{\text{g/L MLVSS}} = \text{mg O}_2/\text{hr/g VSS}$	$\frac{\text{mg/L-hr OUR}}{\text{g/L MLVSS}} = \text{mg O}_2/\text{hr/g VSS}$

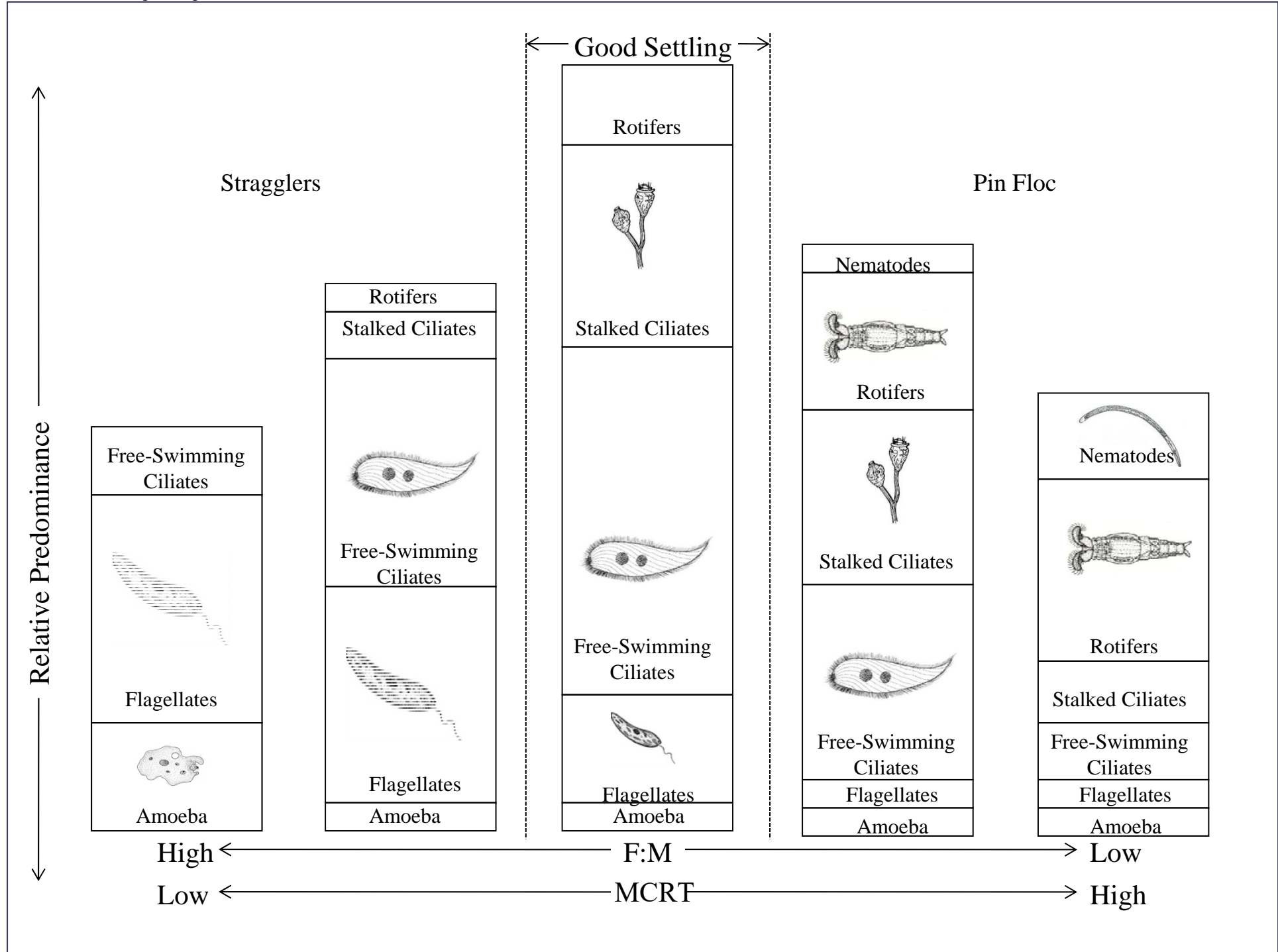

# Activated Sludge: Basic Operations and Troubleshooting

**A**ctivated sludge is a process by which air is added to the system to treat wastewater. The object is to provide oxygen for organisms or bacteria to grow and reduce the organic waste (BOD) in the wastewater. All wastewater treatment facilities should follow the operation and maintenance guidance provided when the system was constructed. Following the O&M manual originally provided should allow the plant to produce the best effluent quality for the system.

There are four main pieces of equipment that operators should have available that will provide basic information needed for the proper treatment of the waste. This article reviews the equipment and information that equipment provides. It should be understood that no one piece of equipment is more or less important than the other, but that all are needed for proper system evaluation and process control. Combined with additional operating data, operators can use the information to provide the best effluent quality for activated sludge plants. Also remember every treatment plant and the influent waste are different, so what works well for one may not work as well in another system.

## Dissolved Oxygen Meter

The Dissolved Oxygen meter or commonly called the "DO meter" can vary in cost from \$700 to over \$1,500. These also vary in how often they need to be calibrated and their maintenance cost. Choose the right one for your system. Remember, maintaining the proper DO in your system will save in electrical costs over time and could pay for the better DO Meter.

In most cases the DO should not drop below 1 mg/l in the system, and depending on the system, it may be necessary to maintain the DO as high as 2 or 3 mg/l. Maintaining a DO much higher than these levels is generally a waste of electricity. Some of the newer wastewater treatment



Kyle Headrick, Wastewater Operator at the city of Hesston, performs a settleability test. The Hesston plant consistently has non-detects on BOD and TSS in the effluent discharge.

**All wastewater treatment facilities should follow the operation and maintenance guidance provided when the system was constructed.**

facilities are using variable frequency drives (VFD's) connected to the DO probe that will ramp the blowers up or down to maintain proper DO for the system. Also, remember that DO will be higher when weather conditions are cold rather than warm.

If the DO drops much below 1 mg/l, the system may be starving the bacteria of needed oxygen.

When the Return Activated Sludge is returned to the start of the treatment works, operators may want the DO to be in this lower range so that the bacteria will strip the oxygen from nitrates and nitrites and convert it to nitrogen for nutrient removal.

## Settleometer

The Settleometer has a purchase cost of between \$50 to \$175. A settleometer is usually at least a liter in volume, however, some operators prefer the two-liter graduated cylinder. Some of the observations an operator should be looking at are: color, odor, floc, surface, supernatant, voids, and time it takes sludge to settle.

If the sludge in the sample is a light brown color, this is usually an indication of a young sludge. While performing

the settleability test, if the sample has an odor similar to the influent, then it is probably a young sludge. Young sludge will have a small floc and may have solids on the surface. The supernatant for young sludge will have solids floating and be cloudy in appearance. There should be no voids noticed in the settled floc for young sludge. The young sludge does not settle quickly. In the first five minutes it may settle less than 50 mg/l, so the reading would be around 950 mg/l on the jar; this will settle only about 100 mg/l total to about 900 mg/l.

Since these settleometer results could also be a sign of old sludge, an operator may want to dilute the sample using 50 percent effluent water and 50 percent sample, and compare it to an undiluted sample. Both tests need to be conducted at the same time. This will require two settleometers – one with diluted sample and the other undiluted. If the sludge in the diluted sample settles significantly faster than the undiluted sample, this indicates old sludge, which may have filamentous micro-organisms, and “wasting” is recommended.

“Wasting” is a term used for removing excess sludge from the treatment process. If operated correctly, all activated sludge plants eventually build up an excessive concentration of biological floc (bacteria). To prevent “overcrowding”, sludge wasting is employed. Wasting is used to keep the ratio of the biological floc to food supplied in balance. The sludge is usually drawn from a digester after sufficient processing; it can be dewatered or dried and then be land applied, taken to a landfill or used in a composting operation.

The color for adult/normal sludge is light chocolate brown. This is where operators will most likely want the sludge at the plant to be. There should be no odor and the surface of the sample should be relatively clear with possibly only minimal floating debris. There may be a small amount of floating material, depending on the exact age of the sludge. For adult sludge age, the supernatant will be clear and there will be voids in the settled sludge. When the sludge settles in this stage, the five-minute settling rate should be about 150 mg/l to 300 mg/l, or the reading should be 850 mg/l to 700 mg/l. The 30-minute settling rate should be about 200 to 300 mg/l.

When sludge is too old, the color will be dark brown to gray/black; the operator will most likely want to start wasting some of this sludge. The sample may smell like methane, hydrogen sulfide or musty and may be covered by ashing. The older sludge will be cloudy with some pin floc noticed. Voids will be extremely small in the older sludge. Settling for this age sludge varies but will settle to

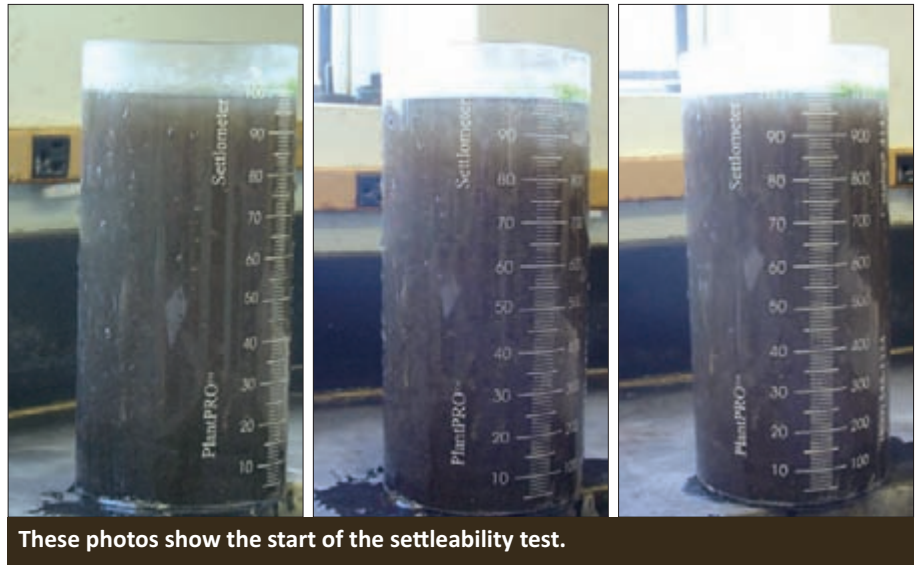

These photos show the start of the settleability test.

about 300 mg/l or more in five minutes and to 200 mg/l or less in 30 minutes. This is when the operator may also want to waste more sludge.

Wasting consistently in small increments is better than wasting a lot all at once. For example, it’s better to waste 1,000 gallons per day than to waste 7,000 gallons once per week. Wasting large amounts of sludge at any one time which can have a negative effect on plant performance and plant effluent.



## Activated sludge

### Microscope

The next piece of equipment that will greatly assist an operator with evaluating treatment processes is the microscope. Microscopes can range in price from \$500 to \$1,500 or more. Generally a simple microscope with 100 power and reasonable resolution will work well for most systems.

Depending on the microscope, in young sludge the operator should see substantial free-swimming ciliates and zoo flagellates. Then, as the sludge gets to the adult or normal stage, the operator will see less of those mentioned above and see more stalked ciliates, a few free-swimming ciliates from the young sludge, and a few rotifers. As the sludge age progresses, the operator will see mostly rotifers and a few stalked ciliates. As sludge is wasted, there may be no discernable change in the microorganisms under the microscope but as long as it is in the normal range the system should operate fine. The problem occurs when there is too much or too little sludge wasted. If the operator does not consistently waste, the cycle will start again which could upset the balance of the treatment works.



The results of the settleability test after five minutes



The results after 30 minutes

### Centrifuge

Another helpful piece of equipment is the centrifuge; this is used to determine solids concentration. The following is an example of how to convert the sludge volume in mg/l to a concentration in percent. If a 15-ml centrifuge tube is used, the tube factor would be 100 divided by 15 for a tube factor of 6.67. After spinning, if the sludge volume is 1.2, then the percent concentration would be  $1.2 \times 6.67 = 8.0$  percent. Using the same procedure, if 50-ml tube is used, the factor would be 2. Using the same sludge volume of 1.2, this would be  $1.2 \times 2 = 2.4$  percent.

This article, as stated in the title, provides the very basics of activated sludge operation and troubleshooting. There are numerous training manuals on the subject. In my opinion, one of the foremost manuals is that by Tim Hobson entitled "Activated Sludge-Evaluating and Controlling Your Process". With a retail price of approximately \$20, copies can be ordered [www.hobsonschoicepress.com](http://www.hobsonschoicepress.com). I relied on information from the training manual; I also reviewed California State University, Sacramento training manuals, "Advanced Wastewater Treatment" and "Operations of Wastewater Treatment Plants" for reference materials for this article.

*Charlie Schwindamann has been Wastewater Tech at KRWA since September 1999. Charlie holds Class II Water and Class I Wastewater Operator certification. He is a member of the Marysville, KS City Council.*





## Section 8 WET Testing

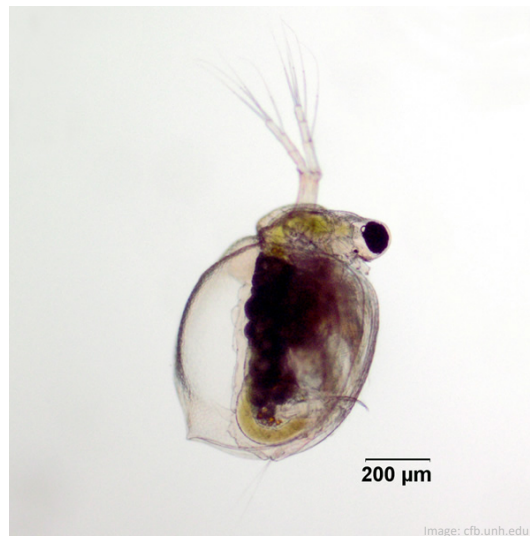

# Whole Effluent Toxicity (WET) Testing

WASTEWATER LABORATORY CLASS

## What is a WET test?

- ▶ Also known as "Biomonitoring"
- ▶ A test to assess the effect that a permitted wastewater discharge may have on the aquatic organisms in the receiving waters.
- ▶ Expose living aquatic organisms to effluent in a controlled test.
- ▶ The test simulates and measures the interaction between aquatic organisms and effluent constituents in the receiving water.
- ▶ Measures the toxicity of whole effluents and receiving water on test organisms
- ▶ Measures the toxicity of whole effluents and receiving water on test organism's ability to survive, grow, and reproduce.

## History

- ▶ EPA began to evaluate biomonitoring as a tool to protect lakes and streams in the US during the late 1970's/early 1980's.
- ▶ Effluent toxicity data can be used to monitor compliance with safe water quality standards, and can also be used to set permit limits.
- ▶ National Pollutant Discharge Elimination System (NPDES) permits began to require WET testing in the mid 1980's. (approved method in 40 CFR 136)
- ▶ One of the ways the EPA implements the Clean Water Act's prohibition of the discharge of toxic pollutants.
- ▶ A proactive method of protecting the environment

## Why WET Test?

- ▶ Objective: to estimate the safe or no effect concentration of effluents, which is defined as the concentration which will permit normal propagation of fish and other aquatic life in the receiving waters.
- ▶ The term "whole effluent toxicity" (WET) refers to looking at effluent as a single component. Thus, the test will not identify the specific contaminant that produces toxicity.
- ▶ WET test refers to the combined toxic effect to aquatic organisms from all pollutants contained in a wastewater effluent
- ▶ It simulates the environment that occurs where the discharge mixes with receiving water.

## Why WET Test?

- ▶ Chemical and physical tests alone are not sufficient to assess potential effects on aquatic biota.
- ▶ Toxicity may be caused by a mixture of contaminants, which separately do not cause toxicity. The individual contaminants could be within NPDES permit limits and still produce toxicity.
- ▶ Cost-effective approach - one test to assess all chemicals and additive and/or synergistic effects

## Who has to WET test?

- ▶ TDEC Division of Water Resources evaluates all discharges for a reasonable potential to exceed "no toxics in toxic amounts"
- ▶ NPDES permit will require WET testing if toxicity is suspected or demonstrated, a pretreatment program is required, or the design capacity of the facility is greater than 1.0 mgd (million gallons per day)
  - ▶ Municipal wastewater treatment plants
  - ▶ Industry
  - ▶ Storm water runoff
- ▶ Permit should contain WET monitoring requirements that are representative of the monitored effluent discharge

### Most commonly identified toxicants in wastewater effluent

- ▶ Chlorine
- ▶ Ammonia
- ▶ Organophosphate insecticides
- ▶ Metals
- ▶ Treatment chemical additives such as:
  - ▶ Dechlorination chemicals
  - ▶ Polymers
  - ▶ Surfactants
- ▶ Total Dissolved Solids (TDS)

### What will we learn from these tests?

- ▶ Is the sample acutely toxic? (lethal)
- ▶ If not acutely toxic, is the sample inhibiting reproduction or growth? (sub-lethal)
- ▶ Is the sample becoming more (or less) toxic over time?
- ▶ Are there any differences between the invertebrate and vertebrate test organisms?
- ▶ Relative sensitivity of aquatic organisms to an effluent or toxicant
- ▶ Effectiveness of waste treatment methods
- ▶ Compliance with water quality standards, effluent requirements, and discharge permits.

### WET Testing Monitoring Schedule

- ▶ States initially require monitoring at least quarterly
- ▶ There are situations where permittee can monitor less frequently
  - ▶ Effluent is stable
  - ▶ No toxicity observed in previous WET tests
- ▶ An appropriate schedule will capture seasonal conditions
  - ▶ Varying receiving water conditions
  - ▶ Varying plant production schedules
  - ▶ Storm water impacts - wet weather impact

### NPDES permit Section 3.4

#### 3.4. BIOMONITORING REQUIREMENTS, CHRONIC

The permittee shall conduct a 3-Brood *Ceriodaphnia dubia* Survival and Reproduction Test and a 7-Day Fathead Minnow (*Pimephales promelas*) Larval Survival and Growth Test on samples of final effluent from Outfall 001.

The measured endpoint for toxicity will be the inhibition concentration causing 25% reduction in survival, reproduction and growth ( $IC_{25}$ ) of the test organisms. The  $IC_{25}$  shall be determined based on a 25% reduction as compared to the controls, and as derived from linear interpolation. The average reproduction and growth responses will be determined based on the number of *Ceriodaphnia dubia* or *Pimephales promelas* larvae used to initiate the test.

### NPDES permit Section 3.4

Test shall be conducted and its results reported based on appropriate replicates of a total of five serial dilutions and a control, using the percent effluent dilutions as presented in the following table:

Serial Dilutions for Whole Effluent Toxicity (WET) Testing					
Permit Limit (PL)	0.50 X PL	0.25 X PL	0.125 X PL	0.0625 X PL	Control
% effluent					
100	50	25	12.5	6.25	0

The dilution/control water used will be moderately hard water as described in Short-Term Methods for Estimating the Chronic Toxicity of Effluents and Receiving Water to Freshwater Organisms, EPA-821-R-02-013 (or the most current edition). A chronic standard reference toxicant quality assurance test shall be conducted with each species used in the toxicity tests and the results submitted with the discharge monitoring report. Additionally, the analysis of this multi-concentration test shall include review of the concentration-response relationship to ensure that calculated test results are interpreted appropriately.

### How to collect effluent samples for testing

- ▶ Effluent specifications listed in NPDES permit
  - ▶ Ex: All tests will be conducted using a minimum of three 24-hour flow-proportionate composite samples of final effluent collected on days 1, 3 and 5.
- ▶ 1 gallon "cubitaier" or 4 L container, filled completely
- ▶ Rinse sample container with sample water before filling
- ▶ Chilled to 4°C during and after sampling
- ▶ WWTP/permittee is responsible for shipping at least three sampling kits over the 7 day period for the test.
- ▶ Hold time: 36 hours from last aliquot collection to beginning of test
- ▶ Samples should be obtained under "normal operating conditions"

## Most common types of WET testing

### Acute Toxicity

- ▶ "End of pipe" conditions
- ▶ Short term (lethal effects)
- ▶ Usually static, renewal or non-renewal
- ▶ Lethality in 48h or 96h periods
- ▶ Measured endpoint is the LC<sub>50</sub>
- ▶ LC<sub>50</sub> = the concentration killing 50% of exposed organisms at a specific time of observation (for example, 48h or 96h)
- ▶ The lower the LC<sub>50</sub>, the more toxic the effluent.
- ▶ Ex: If LC<sub>50</sub> = >100%, the undiluted effluent did not kill at least half of the test organisms.

### Chronic Toxicity

- ▶ Long term (sub lethal effects)
- ▶ Static renewal test
- ▶ 7 day Fathead minnow larval survival and growth test
- ▶ 3 Brood *Ceriodaphnia dubia* survival and reproduction test
- ▶ Generally measured using a multi-concentration, or definitive "serial dilution" test
  - ▶ at least 5 effluent concentrations and a control

## Advantages of Chronic Toxicity over Acute Toxicity

- ▶ Chronic is more sensitive
- ▶ Assess other parameters than just lethality
- ▶ Sub-lethal endpoints of growth, reproduction, and hatchability are more sensitive indicators of chronic toxicity than survival.
- ▶ Provide a more direct estimate of the safe concentrations of effluents in receiving waters at only a slightly increased level of effort

## Test Organisms (freshwater)

### *Ceriodaphnia dubia*

- ▶ Water flea, cladoceran
- ▶ Less than 24 hours old, all born within 8 hours of each other



### *Pimephales promelas*

- ▶ Fathead minnow neonate/larvae
- ▶ Less than 48 hours old, all born within a 24 hour period

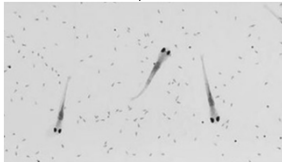

## Test Organisms (freshwater)

### *Ceriodaphnia dubia*

- ▶ Major component of freshwater zooplankton
- ▶ Widely abundant
- ▶ Important link in food chain
- ▶ Short life cycle
- ▶ Easy to culture
- ▶ Sensitive to wide range of contaminants

### *Pimephales promelas*

- ▶ Belong to dominant freshwater family – Cyprinidae
- ▶ In terms of numbers, native to most of North America

## Chronic toxicity test preparation

- ▶ pH, DO, temperature, conductivity, alkalinity, hardness, total residual chlorine are all measured at the lab
- ▶ Effluent test concentrations determined by your NPDES permit
- ▶ Ex: 100%, 50%, 25%, 12.5%, 6.25%
- ▶ Dilution water prepared by lab, based on NPDES permit
  - ▶ Moderately hard synthetic dilution water
- ▶ Effluent that contains undesirable organisms that may attack the test organisms should be filtered through a fine mesh net (60µm opening)
- ▶ Reference toxicant (sodium chloride, potassium chloride, copper sulfate) must be run for quality assurance

## *C. dubia* (Water flea) Chronic Survival and Reproduction Test

- ▶ Test chambers: 30 mL (1 oz) plastic cups
- ▶ 15-20 mL of test solution and 1 water flea into each test chamber
- ▶ 10 test chambers are used for each effluent concentration and for the control
- ▶ Randomized on board, covered loosely with plexiglass to minimize evaporation
- ▶ Incubated at 25+/- 1°C, 16 hours light/8 hours dark
- ▶ Fed (YCT and algal suspension) when test is initiated and daily thereafter
- ▶ Test solution renewed daily, organism transferred to new test chamber via pipette

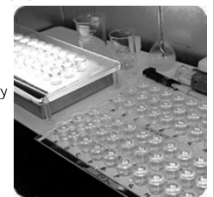

### C. dubia (Water flea) Chronic Survival and Reproduction Test

- ▶ Number of surviving organisms and number of offspring are counted and recorded
- ▶ Test continues 6-8 days
- ▶ Test is terminated when 60% or more of surviving organisms have produced their third brood
- ▶ For test results to be acceptable:
  1. Survival in the control group must be 80% or greater
  2. 60% or more of surviving organisms must have their third brood in 7 +/- 1 days.
  3. Reproduction in the control group must average 15 or more young per surviving organism.



### Fathead Minnow Larval Survival and Growth Test

- ▶ Test chambers: 500 mL (16 oz.) plastic cups
- ▶ 250 mL of test solution and 10-15 fish larvae into each test chamber
- ▶ 4 test chambers are used for each effluent concentration and for the control.
- ▶ Randomized on board, covered loosely with plexiglass to minimize evaporation
- ▶ Incubated at 25 +/- 1°C, 16 hours light/8 hours dark
- ▶ Fed suspension of brine shrimp 2x daily
- ▶ Test solution renewed daily (using most recently collected sample), detritus siphoned out of chamber



### Fathead Minnow Larval Survival and Growth Test

- ▶ Number of live and dead larvae in each test chamber is recorded daily
- ▶ Test continues for 7 days
- ▶ Test is terminated after 7 days of exposure
- ▶ Surviving larvae in each test chamber are counted and prepared as a group for dry weight determination
- ▶ Dried at 60-80°C for a minimum of 24 hours or 100°C for 6 hours and weighed to evaluate growth
- ▶ For test results to be acceptable:
  1. Survival in the controls must be at least 80%
  2. Average dry weight of control larvae surviving at end of test should equal or exceed 0.25 mg

### Test Endpoints

- ▶ No-observed effect concentration (NOEC) = the highest concentration of toxicant to which organisms are exposed that causes no observable adverse effects (i.e. the highest concentration of toxicant in which the values for the observed parameters are not statistically different from the control.)
- ▶ Lowest observed effect concentration (LOEC) = the lowest toxicant concentration in which the values for the measured response are statistically significantly different from those in the control
- ▶ Inhibition Concentration (IC) = toxicant concentration estimated to cause a specified percentage inhibition/impairment in a biological function (ex: IC25 = estimated concentration of toxicant that would cause a 25% reduction in growth of larval fish, relative to the control.)
- ▶ Lethal Concentration (LC) = toxicant concentration estimated to produce death in a specified percentage of test organisms (ex: LC50)

### Results (NPDES 3.4 Biomonitoring Requirements)

NPDES Toxicity will be demonstrated if the IC25 is less than or equal to the permit limit indicated for each outfall. Toxicity demonstrated by the tests specified herein constitutes a violation of this permit.

Parameter	Result	Units	Method
IC25 - C. dubia	4.70	%	1002.0
IC25 - Minnow	>100	%	1000.0
ALK	95.6	mg/l	310.2
Hardness, Total (mg/L as CaCO3)	117.	mg/l	130.1

### What happens if you fail?

The toxicity tests specified herein shall be conducted quarterly (1/Quarter) for Outfall 001 and begin no later than 90 days from the effective date of this permit.

**In the event of a test failure,** the permittee must start a follow-up test within 2 weeks and submit results from a follow-up test within 30 days from obtaining initial WET testing results. The follow-up test must be conducted using the same serial dilutions as presented in the corresponding table(s) above. **The follow-up test will not negate an initial failed test. In addition, the failure of a follow-up test will constitute a separate permit violation.**

In the event of 2 consecutive test failures or 3 test failures within a 12-month period for the same outfall, the permittee must initiate a Toxicity Identification Evaluation/Toxicity Reduction Evaluation (TIE/TRE) study within 30 days and so notify the division by letter. This notification shall include a schedule of activities for the initial investigation of that outfall. **During the term of the TIE/TRE study, the frequency of biomonitoring shall be once every three months.** Additionally, the permittee shall submit progress reports once every three months throughout the term of the TIE/TRE study. The toxicity must be reduced to allowable limits for that outfall within 2 years of initiation of the TIE/TRE study. Subsequent to the results obtained from the TIE/TRE studies, the permittee may request an extension of the TIE/TRE study period if necessary to conduct further analyses. The final determination of any extension period will be made at the discretion of the division.

The TIE/TRE study may be terminated at any time upon the completion and submission of 2 consecutive tests (for the same outfall) demonstrating compliance. Following the completion of TIE/TRE study, the frequency of monitoring will return to a regular schedule, as defined previously in this section as well in Part I of the permit. **During the course of the TIE/TRE study, the permittee will continue to conduct toxicity testing of the outfall being investigated at the frequency of once every three months but will not be required to perform follow-up tests for that outfall during the period of TIE/TRE study.**

## After a failure, everything is suspect

- ▶ Sampling: containers, tubing, sampling machines, etc.
- ▶ Carefully review plant conditions
  - ▶ Loading conditions (hydraulic, organic, metals, internal loads, dechlorination)
  - ▶ Did the plant receive any hauled in waste such as septage or FOG?
  - ▶ Industries discharging into the collections system?
  - ▶ If there have been multiple failed tests, are there any common factors?
  - ▶ Look at the plant operating conditions at the time of sampling
  - ▶ Were there any process changes during time of sampling?
  - ▶ Did operators observe any visual changes, odors, or noises?
  - ▶ Mechanical issues or failures?

## Indicator Organism Sensitivity

- ▶ The most common reasons for failure: Chlorine and Ammonia
- ▶ Water Flea (*C. dubia*) is a general indicator of toxicity from metals and other inorganics
  - ▶ More sensitive to low pH, metals toxicity increases with lower pH
- ▶ Fathead Minnow (*P. promelas*) are generally sensitive to ammonia and organics
  - ▶ Higher pH = ammonia present as  $\text{NH}_3$  (gas), which is toxic to fish
  - ▶ Cationic polymers can clog gills, products with higher charge density are more toxic. (Alum and ferric sulfate were less toxic.)
  - ▶ Cured-in-place-pipe (CIPP) in collection systems - phthalate in pipe resin

## Toxicity Reduction Evaluation (TRE)

- ▶ An investigation to determine the steps needed to remove toxicity
- ▶ Systematic evaluation of the effluent
- ▶ Process review, evaluation of plant performance, etc.
- ▶ If plant performance is not a principle cause of toxicity or treatment modifications do not reduce effluent toxicity, the next step is to identify the causes of toxicity using a TIE.
- ▶ EPA document "Toxicity Reduction Evaluation Guidance for Municipal Wastewater Treatment Plants"
  - ▶ General framework for conducting TRE's

## What is a TIE? Toxicity Identification Evaluation

- ▶ TIE is a part of the TRE process
- ▶ The use of modified effluent monitoring procedures, which incorporate the permit test species or a suitable surrogate, will help to ensure that the toxicants identified are the ones that specifically affect the species of concern.
- ▶ A series of effluent manipulations at the lab, where the manipulations that are successful give you a clue about the family and characteristics of the toxicant(s) you are looking for.
- ▶ After toxicants are identified in TIE:
  1. Options for treating final effluent
  2. Look into source of toxin and potential upstream treatment options (process modifications, chemical/product substitutions, etc.)

## References

EPA Short-term Methods for Estimating the Chronic Toxicity of Effluents and Receiving Waters to Freshwater Organisms  
[https://www.epa.gov/sites/production/files/2015-08/documents/short-term-chronic-freshwater-wel-manual\\_2002.pdf](https://www.epa.gov/sites/production/files/2015-08/documents/short-term-chronic-freshwater-wel-manual_2002.pdf)

Toxicity Reduction Evaluation Guidance for Municipal Wastewater Treatment Plants  
<https://www3.epa.gov/npdes/pubs/tre.pdf>

Biomonitoring for the National Pollution Discharge Elimination System Permit  
[http://trace.tennessee.edu/cgi/viewcontent.cgi?article=1067&context=utk\\_mtastech](http://trace.tennessee.edu/cgi/viewcontent.cgi?article=1067&context=utk_mtastech)

Standard Methods Examination of Water and Wastewater 20<sup>th</sup> Edition

Rules of the Tennessee Department of Environment and Conservation, Chapter 0400-04-05 Permits, Effluent Limitations, and Standards  
<http://publications.tnsofiles.com/rules/0400/0400-04/0400-04.htm>

## Questions?

### WET Testing – Review Questions

1. “WET” stands for what?
2. The test looks at the sample as a single component or as a “whole.” Explain what that means.
3. What does the WET test measure?
4. What type of environment is the test simulating?
5. What two test organisms are used for WET testing in this part of the country?
6. What are the two most common types of WET test?
7. What type of samples are required for the WET test and what is the hold time?
8. What type of conditions does the Acute Toxicity test simulate? And it looks at what type of effects on the test organisms?
9. What type of conditions does the Chronic Toxicity test simulate? And it looks at what type of effects on the test organisms?





Section 9  
Oil and Grease



## Oil & Grease

Liquid/Liquid  
OR  
Solid Phase

1 TDEC - Fleming Training Center

### Currently Approved Methods

- **As of August 28, 2017**
- **SM 5520 (B, F)–2011**, oil and grease, hexane extractable material (HEM): n-hexane extraction and gravimetry, silica gel treated HEM (SGT–HEM): Silica gel treatment and gravimetry.

41. Oil and grease—Total recoverable, mg/L	Hexane extractable material (HEM): n-Hexane extraction and gravimetry. Silica gel treated HEM (SGT–HEM): Silica gel treatment and gravimetry.	1664 Rev. A; 1664 Rev. B <sup>42</sup> .	5520 B–2011 <sup>58</sup> .
		1664 Rev. A; 1664 Rev. B <sup>42</sup> .	5520 B–2011 <sup>58</sup> and 5520 F–2011 <sup>58</sup> .

2 TDEC - Fleming Training Center

### Sample Collection/Preservation

- Glass wide mouth container (SM 5520A.3)
- Clean sample bottles with solvent
- Grab sample
- Use PTFE-lined caps or line cap with foil
- Collect (3)1 liter of samples (EPA 1664A)
- Acidify to pH < 2 with H<sub>2</sub>SO<sub>4</sub> or HCL
- Cool to ≤6°C and analyze within 28 days

Table II, 40CFR136

41. Oil and grease	G	Cool to ≤6 °C <sup>18</sup> , HCl or H <sub>2</sub> SO <sub>4</sub> to pH <2.	28 days.
--------------------	---	---	----------

3 TDEC - Fleming Training Center

### Summary of Method

- Two basic techniques used are:

1. Liquid/Liquid extraction for partitioning followed by gravimetric determinations. (Std Meth. 5520B).
2. Solid phase extraction followed by elution and then gravimetric determinations.

Method 5520F can be used in conjunction with 5520 B to obtain a hydrocarbon measurement in addition to, or instead of, the oil and grease measurement. It makes use of silica gel to separate petroleum hydrocarbons from the total oil and grease on the basis of polarity.

**Editorial revisions consist of new references to the QC practices considered to be an integral part of each method.** *Note: EPA approval for the indicated methods is for wastewater only.*

4 TDEC - Fleming Training Center

### Significance of O & G

- If present in excessive amount, O&G may interfere with aerobic and anaerobic biological processes and lead to decreased wastewater treatment efficiency.
- Excess amounts of O&G if discharged may cause surface films and shoreline deposits leading to environmental degradation.

5 TDEC - Fleming Training Center

### SOURCES OF O&G

- Animal fat
  - e.g. meat packaging plant & fish processing
- Vegetable Oils
  - e.g. food processing & restaurants
- Petroleum Products
  - e.g. refinery & asphalt

6 TDEC - Fleming Training Center

## EPA METHOD 1664A

- (40CFR136 Table I.b., Footnote 38.)  
Only use n-hexane (n-Hexane-85% minimum purity, 99.0% minimum. Saturated C6 isomers, residue less than 1 mg/L) extraction solvent when determining Oil and Grease residue for either method below:
  - Hexane extractable materials (HEM)
  - Silica-Gel treatment (SGT-HEM) for petroleum products
  - Measurements of materials that volatilize approximately below 85°C

7

TDEC - Fleming Training Center

## Calibration & Standardization

- Calibrate the analytical balance at 2 mg and 100 mg using class "ASTM Class 1" weights
- Calibration shall be within  $\pm 10\%$  at 2 mg and  $\pm 0.5\%$  at 1000 mg. If values are not within these limits, the balance must be recalibrated

8

TDEC - Fleming Training Center

## Liquid/Liquid Extraction Procedure

- Volume measurements
  - Mark sample bottle
  - Weigh sample and bottle
- Check pH of sample ( $<2$ ) with stirring rod
- Transfer sample to a 2L separatory funnel
- Vigorous extraction for 2 minutes each with 30 mL hexane
- Extract sample three times; drain solvent layer with each extraction

9

TDEC - Fleming Training Center

## Liquid/Liquid Extraction Procedure (continued)

- Filter each extraction (solvent layer) through a funnel containing 10g of  $\text{Na}_2\text{SO}_4$  (sodium sulfate), rinse with hexane and collect into a pre-weighed boiling flask
- Distill solvent from flask in a water bath at 85°C and collect solvent in an ice-bath-cooled receiver.
- Draw air through the flask with applied vacuum for final one minute to remove any remaining solvent vapors

10

TDEC - Fleming Training Center

## Liquid/Liquid Extraction Procedure (continued)

- Desiccate boiling flask containing residue until a constant weight is obtained (generally, this takes about 30 minutes).
- Weigh boiling flask and residue until measurement reaches a constant weight; within 4% or less than 0.5 mg whichever is less.

11

TDEC - Fleming Training Center

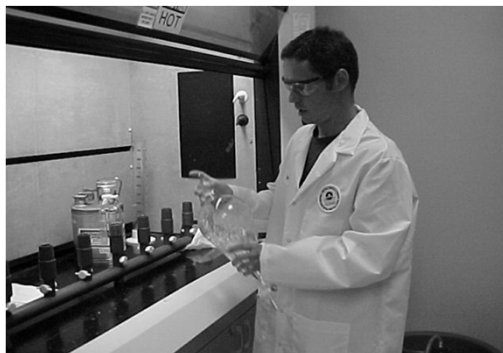

12

TDEC - Fleming Training Center

### Solid Phase Extraction Procedure (Std Meth 5520 B and F)

- Volume measurements
  - Mark sample bottle
  - Weigh sample and bottle
- Check pH of sample (<2) with stirring rod
- Filter sample through solid phase disks
- To 100 mL solvent add 3.0 g silica gel/100 mg total oil and grease, up to 30 g silica gel (1000 mg total oil and grease)
- Stopper container and stir on a magnetic stirrer for 5 minutes.

13

TDEC - Fleming Training Center

### Solid Phase Extraction Procedure (Std Meth 5520 B and F)

- For gravimetric determinations, filter solution through filter paper pre-moistened with solvent, wash silica gel and filter paper with 10 mL solvent and combine with filtrate.
- For solvent stripping and recovery and for cooling extraction flask before weight, Follow previously provide instructions in 5520B.

14

TDEC - Fleming Training Center

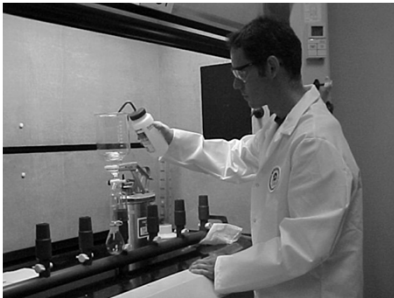

TDEC - Fleming Training Center

15

### Calculations

$$Mg/L = \frac{final\ wt - initial\ weight(mg) \times 1000}{volume\ of\ sample(mL)}$$

16

TDEC - Fleming Training Center

### Quality Control

- Initial demonstration of ability for accuracy and precision.
- Blanks
- Method Detection Limit (MDL) Study (updated August 28, 2017)
- Standard (Laboratory Control Sample (stearic acid & hexadecane))
- Spikes
- Matrix Spike Duplicate

17

TDEC - Fleming Training Center

### Waste Management



- It's the facilities responsibility to make sure the waste is recycled or disposed of properly

18

TDEC - Fleming Training Center

**Section 10**  
**Answers to**  
**Review Questions**

## Answers to Review Questions

### Laboratory Safety – p. 15

1. Infectious Materials, Poisons, Explosions, Cuts and Bruises, Electric Shock, Toxic fumes, Fire, Burns
2. Someone should always be there to help you in case you should have an accident that blinds you, leaves you unconscious, or starts a fire you cannot handle. If necessary, have someone check on you regularly.
3. True
4. You can dispose of small amounts of corrosive acids by pouring the neutralized acid down a corrosion-resistant sink (to the sewer) and using large quantities of water to dilute and flush the acid.
5. Safety Data Sheet
6. 30 years
7. A signal word is used to indicate the relative level of severity of hazard and alert the reader to a potential hazard. Danger = more severe hazard, Warning = less severe hazard
8. Within one minute of contact, flush with copious amounts of water for at least 20 minutes. Consult our doctor.
9. Immediately wash the area with water and neutralize the acid with sodium bicarbonate (baking soda) or bicarbonate
10. Gloves, safety glasses, apron, lab coat, face shield, closed toe shoes
11. Fume hood
12. Vinegar neutralizes bases, baking soda neutralizes acids
13. Weekly
14. False
15. If incompatible chemicals are inadvertently mixed, a fire, explosion, or toxic release can easily occur.
16. Glass plate, wet towel, wet blanket
17. A – ordinary combustibles, B – flammable and combustible liquids, C- energized electrical equipment, D – combustible metals
18. Pull, Aim, Squeeze, Sweep
19. The potable water source could become contaminated with bacteria or dangerous chemicals. The air gap is the best method because it completely eliminates the cross connection entirely.
20. A reproductive toxin that may cause damage to the fetus.

### Laboratory Equipment – p. 47

1. Beakers
2. Volumetric glassware
3. When you are creating standards
4. Volumetric – do not blow out; Mohr – do not blow out; Serological – yes, blow out
5. TC (To Contain) will accurately measure how much of a liquid is held in the container. TD (To Deliver) will measure the amount that will be poured from the container.
6. True
7. Pipet – hold it up to eye level; Larger glassware – set it on a flat surface and bend down to read at eye level

8. Place them into soapy water, tip up in a pipet cleaner. Or lay them into a dish filled with soapy water. Phosphate free, lab grade soap should be used.
9. 3 minutes
10. 121 degrees C at 15 psi for 15 min
11. 20 +/- 1 degree C; record temperatures twice daily with at least 4 hours apart
12. Analytical is more precise, can weigh down to 0.0001g vs. 0.01g for a top loading balance.
13. Goggles, gloves, aprons, safety clothing (including closed toe shoes)
14. False
15. Weekly
16. Phosphate free (ex: Alconox)
17. Detergent, tap water, rinse 3 times with DI water, air dry
18. To remove any built-up residue that could be causing water to bead up. To ensure glassware is as clean as possible.
19. Clean glassware using lab detergent (phosphate free); rinse with tap water; rinse with 1:1 hydrochloric acid or nitric acid (1:1 means equal part distilled water and acid); rinse well with distilled water; let air dry
20. Monthly

Sampling – p. 61

1. a) 40 CFR 136 Table II b) 40 CFR 136 Table II c) 40 CFR 136 Table II d) NPDES permit e) NPDES permit
2. Representative of the wastestream
3. A grab sample is a single influent or effluent sample collected at that exact moment in time. It is not an average. A composite sample is a combination of not less than 8 influent or effluent portions, of at least 100 ml, collected over a 24 hour period. It is combined to form a sample that is representative of the entire flow for a set period of time.
4. TRC, DO, coliforms, E.coli, pH, temperature
5. BOD, total N, settleable solids
6. To prevent growth of bacteria or algae
7. To prevent bacterial decomposition; at 6 degrees C
8. Location of where the sample was taken, date/time, sampled by (with operators name or initials), and any important comments (such as preservatives that were added or pH adjustments that were made)
9. True
10. COC is a written record to trace possession and handling of samples from collection to reporting. It should identify who handled the sample from collection, through transport, to storage, to analysis, to final destruction. An operator would need to fill out a COC if they are sending their samples out to a contract lab for analysis.
11. True
12. C
13. False
14. Improper sampling, poor or improper sampling preservation, and lack of sufficient mixing during compositing and testing
15. True

Solutions Chemistry – p. 70

1. A liquid containing a dissolved substance. The liquid alone is called the solvent, the dissolved substance is called the solute. Together they are called a solution.
2. Solute + Solvent
3. A
4. B
5. (a) sodium hydroxide (b) hydrogen sulfide (c) calcium carbonate (d) sodium bicarbonate
6. (From top down) Atomic mass, Symbol, Atomic number
7. (a) 22.98977 (b) 40.08 (c) 1.00794 (d) 15.9994 (e) 14.0067 (f) 35.453 (g) 32.06
8. A method of expressing the concentration of a solution. It is the number of equivalent weights of solute per liter of solution.
9. A measure of concentration defined as the number of moles of solute per liter of solution.
10. A solution in which the exact concentration of a chemical or compound is known.
11. When you are calibrating an instrument (ex: pH meter uses standards 4, 7, 10),  
When you are conducting Proficiency Testing (PTs),  
When you are running your Lab Fortified Blank, Lab Fortified Matrix/LFM Dup



Wastewater Laboratory – Solutions Chemistry and Math

1. A laboratory solution is made using 52 milligrams of sodium chloride (NaCl) dissolved in 1-liter volumetric flask filled to the mark. What is the mg/L concentration of the solution?

$$\frac{52 \text{ mg}}{1 \text{ L}} = 52 \text{ mg/L}$$

2. If 33 pounds of a chemical is added to 148 pounds of water, what is the % strength by weight? % strength =  $\frac{\text{weight of solute}^*}{\text{weight of solution}^{**}} \times 100$

\* solute = the chemical

\*\* solution = weight of solute + weight of solvent

$$\begin{aligned} &= \frac{33}{33+148} \times 100 \\ &= \frac{33}{181} \times 100 \\ &= 18.2\% \end{aligned}$$

3. You are given 100 mL of 2.8N HCl. How many mL of water should be added to make 0.4N HCl?  $C_1 V_1 = C_2 V_2$

$$\begin{aligned} (2.8)(100) &= (0.4)(V_2) \\ \frac{280}{0.4} &= \frac{0.4 V}{0.4} \\ 700 \text{ mL} &= V \end{aligned}$$

$$700 - 100 = 600 \text{ mL added}$$

4. 250 mL of 3N NaOH is diluted to 1000 mL. What is the new normality of the solution?  $N_1 V_1 = N_2 V_2$

$$\begin{aligned} (3\text{N})(250) &= (N_2)(1000) \\ \frac{750}{1000} &= \frac{1000(N_2)}{1000} \\ 0.75 \text{ N} &= N_2 \end{aligned}$$

5. 500 mL of 10N NaOH is diluted to 1 liter. What is the new normality of the solution?  $N_1 V_1 = N_2 V_2$

$$\begin{aligned} (10\text{N})(500) &= (N_2)(1000) \\ \frac{5000}{1000} &= \frac{(N_2)1000}{1000} \\ 5 \text{ N} &= N_2 \end{aligned}$$

11. An operator needs a 0.2N solution in order to conduct analysis. The operator has 2.5N solution on hand. How many mL of the 2.5N solution is needed to make one-half liter of 0.2N solution?

$$C_1 V_1 = C_2 V_2$$

$$(2.5N)(V_1) = (0.2N)(500 \text{ mL})$$

$$\frac{2.5(V_1)}{2.5} = \frac{100}{2.5}$$

$$V_1 = 40$$

12. An operator needs to make 1-liter of a 1N and a 1M solution of sodium bicarbonate ( $\text{NaHCO}_3$ ). How many grams would be needed for each? (Hint: bicarbonate =  $\text{HCO}_3^-$ ) (Hint #2: Look at page of "Common Valences")

$$\begin{array}{l} \text{Na} \rightarrow 22.98977 \times 1 = 22.99 \\ \text{H} \rightarrow 1.00794 \times 1 = 1.01 \\ \text{C} \rightarrow 12.0111 \times 1 = 12.01 \\ \text{O} \rightarrow 15.9994 \times 3 = 48.00 \\ \hline 84.01 \end{array} \left. \vphantom{\begin{array}{l} \text{Na} \\ \text{H} \\ \text{C} \\ \text{O} \end{array}} \right\} \text{Na}^+ \text{HCO}_3^-$$

$$\begin{aligned} \text{Molarity: Grams needed} &= (\text{molarity needed})(\text{molecular weight})(\text{Liter soln}) \\ &= (1M)(84.01)(1L) \\ &= 84.01g \end{aligned}$$

$$\begin{aligned} \text{Normality: Grams needed} &= \frac{(\text{normality needed})(\text{molecular weight})(\text{Liter soln})}{\# \text{ of positive charges}} \\ &= \frac{(1N)(84.01)(1L)}{1} \rightarrow = 84.01g \end{aligned}$$

13. An operator needs to make 1-liter of a 1N and a 1M solution of sodium hydroxide ( $\text{NaOH}$ ). How many grams would be needed for each? (Hint: Look at page of "Common Valences")

$$\begin{array}{l} \text{Na} \rightarrow 22.98977 \\ \text{O} \rightarrow 15.9994 \\ \text{H} \rightarrow 1.00794 \\ \hline 39.99711 \rightarrow 40 \end{array} \left. \vphantom{\begin{array}{l} \text{Na} \\ \text{O} \\ \text{H} \end{array}} \right\} \text{Na}^+ \text{OH}^-$$

$$\begin{aligned} \text{Molarity} &= (1M)(40)(1L) = 40g \\ \text{Normality} &= \frac{(1N)(40)(1L)}{1} \\ &= 40g \end{aligned}$$

14. An operator needs to make ½-liter of a 5N and a 5M solution of ferric sulfate  $\text{Fe}_2(\text{SO}_4)_3$ . How many grams would be needed for each? (Hint: Look at page of "Common Valences")

$$\begin{array}{r}
 \text{Fe} \rightarrow 55.847 \times 2 = 111.694 \\
 \text{S} \rightarrow 32.06 \times 3 = 96.18 \\
 \text{O} \rightarrow 15.9994 \times 12 = \underline{191.9928} \\
 \hline
 399.8668
 \end{array}
 \left. \vphantom{\begin{array}{r} \text{Fe} \\ \text{S} \\ \text{O} \end{array}} \right\} \text{Fe}_2^{-3}(\text{SO}_4)_3^{-2}$$

$$\begin{aligned}
 \text{molarity} &= (5 \text{ M})(399.8668)(0.5 \text{ L}) \\
 &= 999.7 \text{ g}
 \end{aligned}$$

$$\begin{aligned}
 \text{normality} &= \frac{(5 \text{ N})(399.8668)(0.5 \text{ L})}{6} \\
 &= 166.6 \text{ g}
 \end{aligned}$$

#### Answers

- |                    |                    |                     |
|--------------------|--------------------|---------------------|
| 1. 52 mg/L         | 8. 50 mL           | 13. 40 g for 1M     |
| 2. 18.2%           | 9. 2.25N           | 40 g for 1N         |
| 3. 600 mL to add   | 10. 292 mL to add  | 14. 999.78 g for 5M |
| 4. 0.75N           | 11. 40 mL          | 166.6 g for 5N      |
| 5. 5N              | 12. 84.01 g for 1M |                     |
| 6. 525.5 mL to add | 84.01 g for 1N     |                     |
| 7. 66.67 mL        |                    |                     |

## Chlorine – p. 95

1. .891 g/L Potassium Permanganate Standard Solution
2. 4 – 5, preferably 5
3. Volumetric
4. True
5. False
6. The plastic can create a demand that will deplete the standard and cause your readings to be lower.
7. Spiked samples = 8/year (2/quarter), Blanks = 0 additional blanks because you will use routine method blanks
8. At least once every 13 months
9. Disinfection, sterilization
10. Disinfection – killing pathogenic microorganisms
11. Dose = Residual + Demand
12. Hypochlorous Acid and Hypochlorite ion
13. RAS line
14. C
15. When ammonia or organic nitrogen is also present, chloramines known as monochloramine, dichloramine, and trichloramine will quickly form. Chloramines are also known as combined chlorine. Total chlorine is the sum of free chlorine and combined chlorine. Total residual = free residual + combined residual.
16. Run a bacterial analysis.

## Ammonia – p. 122

1. To clean out (or steam out) the distillation apparatus until distillate shows no traces of ammonia and to get rid of interferences
2. Concentration and presence of interferences
3. Where interferences are present or greater precision is necessary
4. Chlorine is an interference. Residual chlorine reacts with ammonia (to form chloramines?) Sodium thiosulfate
5. Cool at  $\leq 6^{\circ}\text{C}$ , drop pH to  $< 2$  using  $\text{H}_2\text{SO}_4$ , 28 days
6. Ammonia-Selective Electrode Method (4500-NH<sub>3</sub> D.) and Hach Method 10205 using TNT 830
7. 0.04N  $\text{H}_2\text{SO}_4$  (sulfuric acid)
8. Reagent preparation, Steaming out equipment, Sample preparation, Sample distillation
9. 40 mL
10.  $\text{NH}_3$  (Ammonia) which is more prevalent at higher pH and higher temperatures
11. Ammonium, Ammonia, Nitrite, Nitrate, Nitrogen Gas
12. Increased chlorine demand, fish toxicity, increased oxygen demand in receiving waters
13. Creates dissolved oxygen sag in the stream, Toxic to fish and other aquatic life, Could pose a possible problem for downstream water supplies, Nutrient input (when oxidized)
14. Nitrite and then Nitrate
15. Denitrification

16. TKN + NO<sub>2</sub> + NO<sub>3</sub>
17. Total Kjeldahl Nitrogen, made up of NH<sub>3</sub> and Organic Nitrogen
18. Adding a strong base, bringing the pH up to 11.
19. "Manual distillation is not required if comparability data on representative effluent samples are on file to show that this preliminary distillation step is not necessary: However, manual distillation will be required to resolve any controversies. In general, the analytical method should be consulted regarding the need for distillation. If the method is not clear, the laboratory may compare a minimum of 9 different sample matrices to evaluate the need for distillation. For each matrix, a matrix spike and matrix spike duplicate are analyzed both with and without the distillation step. (A total of 36 samples, assuming 9 matrices.) If results are comparable, the laboratory may dispense with the distillation step for future analysis. Comparable is defined as <20% RPD for all tested matrices. Alternatively the two populations of spike recovery percentages may be compared using a recognized statistical test. Note: Tennessee recommends that one sample is run yearly to compare the distilled and undistilled results and that the results are within 20% of each other (this applies to the probe method).

Nutrients – p. 163

1. Method 10209/10210 TNTplus843 Reactive (Orthophosphate) and Total Phosphorus
2. In order to break down organic phosphates, it is necessary to rigorously digest the sample first with sulfuric acid and heat, and also with the addition of a strong oxidant to break the orthophosphate free of the organic bond.
3. Ascorbic Acid
4. Orthophosphate
5. Phosphate contamination is common because of its absorption on glass surfaces. Preferably, reserve the glassware only for phosphate determination, and after use, wash and keep filled with water until needed. If this is done, acid treatment is required only occasionally. [4500-P.C.2b.] Commercial detergents contain phosphate and will lead to contamination/inaccurate results.
6. Total N, mg/L; NO<sub>3</sub>-N + NO<sub>2</sub>-N; TKN
7. Inorganic and organic nitrogen are oxidized to nitrate by digestion. The Nitrate ions react to form a nitrophenol, which is read by the spectrophotometer (in test vial 1). Oxidized forms of nitrogen in the original (undigested) sample (nitrite + nitrate due to sample preservation) are determined in the second test vial and then subtracted from the first vial, which results in TKN.
8. Carbon, Nitrogen, Phosphate
9. Ortho (reactive), Condensed (Ex: poly), and organically bound
10. Orthophosphate, Acid Hydrolyzable Phosphate/Condensed Phosphate, Total Phosphorous/Organic Phosphate
11. Total Kjeldahl Nitrogen. Ammonia + Organic Nitrogen
12. An increase in chemical nutrients (compounds containing nitrogen or phosphorus) in an ecosystem, which may occur on land or in water, and leads to the resultant increase in the ecosystem's primary productivity (excessive plant growth and decay)

13. Excessive plant growth, unsightly scum of algae on water surface, lack of oxygen, severe reductions in water quality, reduction in fish populations and other animal populations, negatively impact recreational use (boating, fishing, swimming)
14. Nitrite

Alkalinity – p. 214

1. Total Alkalinity
2. 4.5
3. Adding a chemical of known concentration to a sample until you reach a pre-determined endpoint
4. 0.02N H<sub>2</sub>SO<sub>4</sub>
5. Hach method 8221 (USEPA Buret Titration Method) and Hach Method 10239 TNTplus 870 (Colorimetric Method)
6. 4 mL
7. (a) Nitrate
  - (b) We wanted to make denitrification occur. Denitrifying organisms use NO<sub>3</sub> as the terminal electron acceptor during respiration. (They use bound oxygen and release nitrogen gas.)
  - (c) Anoxic zone
  - (d) Nitrate (that was created during the nitrification process, or in our case, added to the beaker) is reduced into Nitrogen gas, which is released to the atmosphere.
  - (e) We expected the beaker with the nitrate addition to have higher alkalinity levels because we hoped to facilitate the denitrification process, which produces alkalinity.
  - (f) 3.6 mg/L alkalinity for each mg/L of nitrate reduced.
8. A measure of the water's capacity to neutralize and acid.
9. It describes the water's ability to resist a change in pH
10. There are many points in the wastewater process that create acid and thus consume alkalinity. Examples of acid producing operations: Nitrification in aeration tanks, TF, RBCs, and aerobic digesters; acid formation stage in anaerobic digestion; gas chlorination for effluent disinfection; chemical addition of aluminum or iron salts; anaerobic conditions in sewer systems; anaerobic conditions in primary clarifiers
11. Highly colored or turbid samples may mask the color change at the end point. You would use a pH meter in these cases. Chlorine can also interfere with the indicators. You would use sodium thiosulfate to eliminate it.
12. Reduced organism activity, may result in low effluent pH, may result in high chlorine demand in the disinfection process
13. In terms of equivalent calcium carbonate (CaCO<sub>3</sub>)
14. Hydroxide, carbonate, bicarbonate
15. 7.1 mg/L CaCO<sub>3</sub> is consumed for every mg/L of ammonia nitrogen oxidized. 3.6 mg CaCO<sub>3</sub> is recovered during the denitrification process.
16. 30 mg/L x 7.1 mg/L = 213 mg/L

Process Control Testing – p. 249

1. Settleometer. Wide mouth containers allow you to see the channels of water squeezing out of the sludge as it compacts. The friction caused by the close walls of the graduated cylinder can slow the settling, change the settling velocities, and give false readings.
2. Agitation will break up the flock that has formed and lead to inaccurate results.
3. If your sample is settling too slowly. Dilute with plant effluent.
4. TSS (Total Suspended Solids)
5. The added step is to place the filter into the muffle furnace at 550°F for 15-30 minutes to burn off the volatile portion. The weight is then subtracted from that of the unburned filter to determine the volatile portion.
6. Sludge Volume Index (SVI), describes the ability of the sludge to settle and compact. SVI gives a more accurate picture of the sludge settling characteristics than settleability or MLSS alone.
7. You can either shake the sample in a partially filled bottle or you can bubble air into it.
8. Process control tests are performed frequently by operators to quickly obtain results and make any necessary process adjustments. NPDES monitoring tests are required by your permit and the data are reported to the State. These tests may be performed by operators, but are also performed by laboratory analysts.
9. Settleability test, Sludge judge, MLSS, MLVSS, Centrifuge spin, DO, Alkalinity, Turbidity, Microscopic examination, OUR, SOUR
10. BOD, CBOD, TSS, Settleable Solids, Chlorine, Ammonia, DO, E.coli
11. Settled Sludge Volume (SSV), how well the sludge is settling and compacting
12. Every 5 minutes for the first 30 minutes and every 10 minutes for the next 30 minutes. If the test goes longer than one hour, take readings every 30 minutes. Show them on the board how these times are written (Ex: SSV<sub>5</sub>)
13. MCRT
14. Representative composite samples of MLSS, Effluent suspended solids, and waste sludge suspended solids. Also measure influent and waste sludge flows.
15. Amoeba, Flagellates, Ciliates (free-swimming, crawling, stalked), Suctoria
16. Rotifers, Water bears, Nematodes, Ostracods.
17. Rotifers and ciliates
18. Small amounts of them can improve floc structure, acting as a backbone and providing mass to help in settling after treatment. Large amounts can negatively affect performance of AS by keeping floc apart, which makes it light and fluffy and therefore not settling well.
19. Oxygen Uptake Rate, rate at which the microorganisms are using oxygen
20. Specific Oxygen Uptake Rate, it accounts for the volatile portion of the MLSS
21. Old sludge, over-oxidized sludge
22. Young sludge

WET Testing – p. 279

1. Whole Effluent Toxicity
2. It looks at the combined toxic effect to aquatic organisms from all pollutants contained in the wastewater. Also looks at additive and/or synergistic effects.
3. The wastewater's effects on specific organisms' abilities to survive, grow, and reproduce.
4. The environment that occurs when the plant effluent/discharge mixes with the receiving waters.
5. Water flea (*Ceriodaphnia dubia*), Fathead minnow (*Pimephales promelas*)
6. Acute and Chronic toxicity
7. Composite samples (minimum of three 24 hour flow-proportionate composite samples of final effluent collected on days 1, 3, and 5 for Chronic tests). Hold time is 36 hours from the collection of the last aliquot to the beginning of the test.
8. "end of pipe" toxicity, short term and lethal effects
9. "mixed water conditions," long-term and sub-lethal effects
10. The Chronic test is more sensitive because it assesses other parameters than just lethality. The endpoints of growth, reproduction, and hatchability are more sensitive indicators. And it provides a more direct estimate of the safe concentrations of the effluent because it better simulates the mixing zone environment in the receiving water.
11. IC stands for the Inhibition Concentration, the concentration that will produce a 25% reduction in whatever parameter, Ex: 25% reduction in growth as compared to the control group.)
12. LC stands for Lethal Concentration, the concentration that will kill/produce death in 50% of the test organisms
13. The permittee must start a follow-up test within 2 weeks and submit those results within 30 days of the initial test results.
14. Toxicity Identification Evaluation/Toxicity Reduction Evaluation