

TENNESSEE'S PLAN FOR NUTRIENT CRITERIA DEVELOPMENT

Revised September, 2019



Watershed Planning Unit
Division of Water Resources
Tennessee Department of Environment and Conservation
11th Floor Tennessee Tower
312 Rosa L. Parks Avenue
Nashville, Tennessee 37243

TABLE OF CONTENTS

		Page
I.	INTRODUCTION	1
II.	CRITERIA DEVELOPMENT OPTIONS	3
III.	TENNESSEE’S WADEABLE STREAM NUTRIENT CRITERIA DEVELOPMENT	5
IV.	CLASSIFICATION BY WATERBODY TYPE	9
	Streams and Rivers	9
	Lakes and Reservoirs	12
	Wetlands	13
V.	CRITERIA DEVELOPMENT APPROACH BY WATERBODY TYPE	14
	Wadeable Streams	14
	Non-wadeable Streams and Rivers	22
	Lakes and Reservoirs	26
	Wetlands	30
VI.	PUBLIC PARTICIPATION AND PEER REVIEW PROCESS	31
VII.	TIMELINE	31
VIII.	NEEDS ASSESSMENT FOR TENNESSEE’S NUTRIENT CRITERIA DEVELOPMENT PROGRAM	40
VIX	REFERENCES	42
	APPENDIX	44

LIST OF TABLES

Table 1	Aggregate ecoregions for rivers and streams	4
Table 2	Aggregate ecoregions for lakes and reservoirs	4
Table 3	90 th and 75 th percentile of reference total phosphorus data by ecological subregion	17
Table 4	90 th and 75 th percentile of reference nitrate+nitrite data by ecological subregion	17
Table 5	Relationship between nutrient levels and nine biometrics at 54 test sites and two reference sites	20
Table 6	Relationship between nutrient levels, canopy cover and nine biometrics at 54 test sites and two reference sites	20

Table 7	Comparison of nutrient data from biologically diverse non-wadeable streams in the Southeastern Plains and Hills	24
---------	---	----

LIST OF FIGURES

Figure 1	Relative impacts of pollution in assessed rivers and streams in Tennessee	2
Figure 2	Level III ecoregions of the United States	3
Figure 3	Level IV ecoregions of Tennessee	6
Figure 4	Nitrate+nitrite regions for wadeable streams in Tennessee	11
Figure 5	Total phosphorus regions for wadeable streams in Tennessee	11
Figure 6	Comparison of sites supporting biological integrity with proposed nutrient criteria at the 75 th and 90 th percentiles of reference data and EPA recommended nutrient criteria.	16
Figure 7	Relationships between total phosphorus and EPT taxa richness during low flow conditions	19
Figure 8	Distribution of Oligochaeta and Chironomidae abundance at sites with nitrate+nitrite levels above and below regional guidelines	19
Figure 9	Comparison of samples passing regional nutrient and/or sediment guidelines to samples scoring a 6 in %NUTOL metric	21
Figure 10	Location of documented impoundments less than 250 acres in Tennessee	28
Figure 11	Location of small lakes and reservoirs located on protected lands in Tennessee	29
Figure 12	Location of impounded test sites with total phosphorus concentrations above regional guidelines	30
Figure 13	Location of impounded test sites with nitrate+nitrite concentrations above regional guidelines	30

TENNESSEE'S PLAN FOR NUTRIENT CRITERIA DEVELOPMENT

SEPTEMBER 2019

I. INTRODUCTION

This plan describes the approach the Division of Water Resources, Tennessee Department of Environment and Conservation, will use to identify and adopt additional water quality standards for nutrient related parameters that protect against measurable impacts to the aquatic environment. Tennessee has already made great strides in incorporating nutrient and biological criteria into its water quality standards. This plan is designed to build upon and refine the achievements already attained in the state.

Tennessee's plan for nutrient criteria development is in response to the U.S. EPA mandate requiring the adoption of nutrient criteria into state water quality standards by 2004. EPA has stated that since both the process for developing standards and the available resources may differ significantly between states, some may not have to adopt standards by 2004 as long as evaluations of progress show that criteria development is well underway and the state's efforts are consistent with its plan.

If U.S. EPA determines a state's plan is not appropriate or if a state has not adopted standards by 2004, the U.S. EPA administrator may exercise authority under section 303(c)(4)(B) of the Clean Water Act and find that promulgation of nutrient criteria for the state is necessary to meet the requirements of the Clean Water Act.

Tennessee had its first Nutrient Criteria Development Plan approved by EPA in 2004 and the document was subsequently revised in 2007. Annual progress reports are submitted to EPA each year. The timeline was adjusted in the 2015 progress report.

The push for nutrient criteria adoption is driven by state water quality inventories that repeatedly cite nutrients as a major cause of water quality use impairments. EPA's national water quality summary reports to Congress consistently identify excessive nutrients as one of the top three leading causes of impairments of the nation's water (along with siltation and pathogens). In Tennessee, nutrients are the fourth leading cause of use impairment in rivers and streams after siltation, habitat alteration, and pathogens (Figure 1). Nutrients are the third leading cause of pollution in reservoirs and lakes after PCBs and siltation.

Under section 303(d), States identify waters that are not attaining water quality standards and submit a list of those impaired waters to EPA. These lists also frequently identify excessive nutrients as a leading cause of impairment. In Tennessee, more than 2,500 stream miles have been identified as impaired due to nutrients. These nutrient-impaired stream segments are found in most of the state's major watersheds.

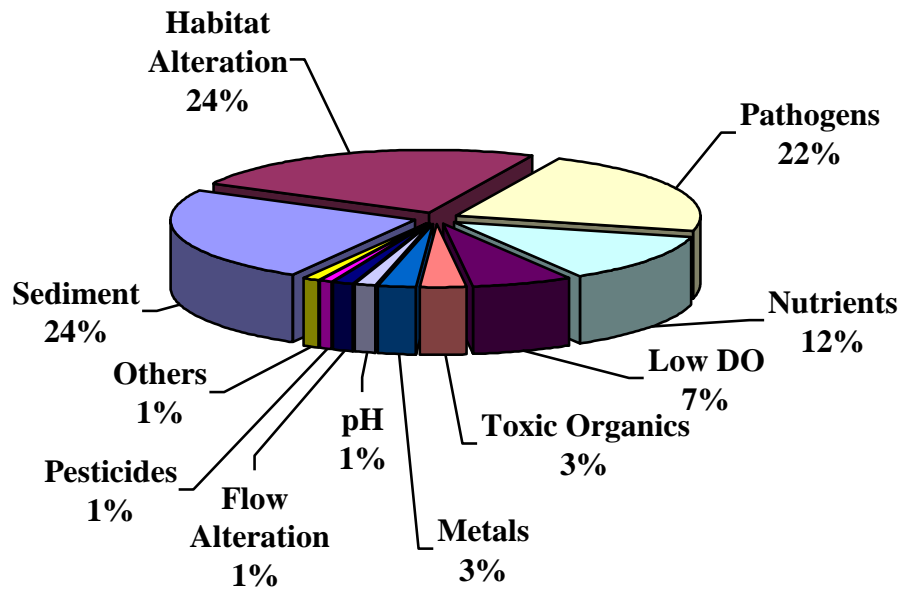

Figure 1: Relative impacts of pollution in assessed rivers and streams in Tennessee (2006 305(b) report)

Tennessee has made considerable progress developing nutrient targets for wadeable streams. However, less progress has been made for other waterbody types such as lakes, reservoirs, wetlands and large rivers. The purpose of this document is to identify methods that, resources permitting, could be used to identify nutrient goals for all the various waterbody types.

IMPORTANT NOTE:

This document is a plan that describes potential approaches for the refinement of existing nutrient criteria and the future development of specific criteria for additional waterbody types. Implementation of this plan will require either additional program resources or the diversion of resources from other program areas.

Nothing in this document should be taken to obligate the Division of Water Resources to a course of action in the absence of program resources.

II. CRITERIA DEVELOPMENT OPTIONS

In 1998, EPA developed a National Nutrient Strategy for the development of a set of national criteria recommendations for nutrients for various waterbody types. The strategy was based on a statistical analysis of data aggregated from Level III ecoregions (Figure 2). Tennessee has three of these nutrient regions: Region IX (Southeastern Temperate Forested Plains and Hills), Region X (Texas-Louisiana Coastal and Mississippi Alluvial Plains), and Region XI (Central and Eastern Forested Uplands). However, only a small portion of Tennessee's land area (Mississippi River delta) is in Region X.

As of 2004, EPA has published national nutrient criteria for streams and rivers, lakes, and wetlands. However, the criteria developed for wetlands are only applicable to a small portion of Florida (Region XIII). Additionally, even for streams and lakes, not all Level III ecoregions are covered.

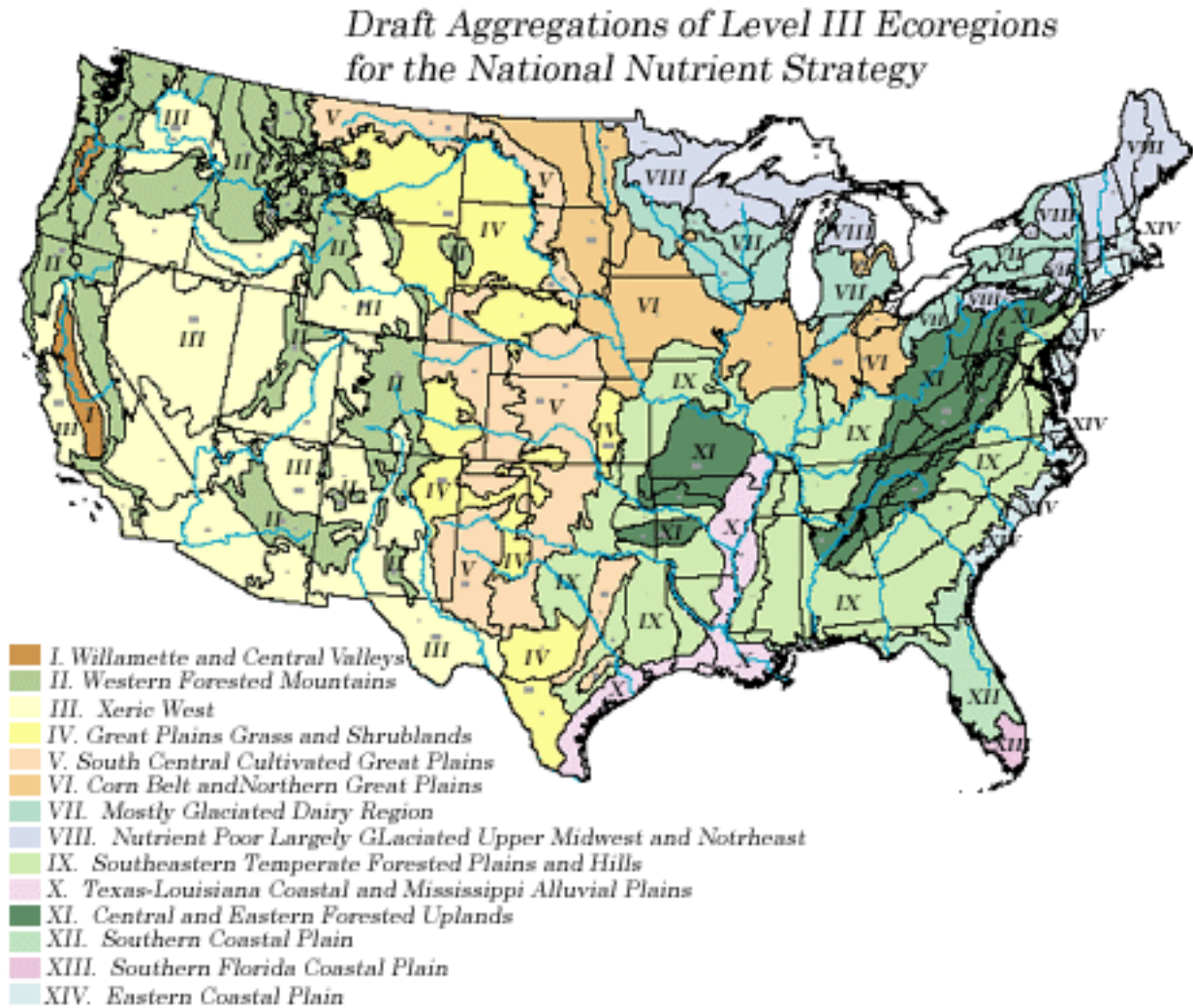

FIGURE 2. Level III ecoregions of the United States. (Source: EPA Office of Water web page.)

Dr. Sherry Wang and Greg Denton of the Tennessee Division of Water Pollution Control participated in the development of the national nutrient criteria for rivers and streams as members of the national criteria development team. A case study from Tennessee appeared in the rivers and streams criteria document. Additionally, Mr. Denton and Dr. Wang served on the nutrient criteria Regional Technical Advisory Group (RTAG) for Region IV.

The following tables summarize the EPA national nutrient criteria recommendations for the three Level III nutrient regions in Tennessee for rivers and streams (Table 1), plus two regions for lakes and reservoirs (Table 2). As stated previously, there are no national nutrient criteria for wetlands in any of the three Level III ecoregions in Tennessee. The source of these data was EPA’s nutrient criteria webpage, Summary Table for Nutrient Criteria Documents, which can be accessed at (<http://www.epa.gov/waterscience/criteria/nutrient/ecoregions/>).

Table 1. Aggregate ecoregions for rivers and streams

PARAMETER	ECOREGION IX	ECOREGION X	ECOREGION XI
Total Phosphorus (ug/L)	36.56	128.00*	10.00
Total Nitrogen (mg/L)	0.69	0.76	0.31
Chlorophyll <i>a</i> (ug/L)	0.93	2.10	1.61
Turbidity (FTU/NTU)	5.70	17.50	2.30

* EPA believes that this value may be a statistical anomaly and recommends further evaluation.

Table 2. Aggregate ecoregions for lakes and reservoirs

PARAMETER	ECOREGION IX	ECOREGION X	ECOREGION XI
Total Phosphorus (ug/L)	20.00	Under development	8.00
Total Nitrogen (mg/L)	0.36	Under development	0.46
Chlorophyll <i>a</i> (ug/L)	4.93	Under development	2.79
Secchi Depth (meters)	1.53	Under development	2.86

If EPA were required to promulgate nutrient criteria for individual states, the criteria would be based on EPA's published national recommendations. However, EPA has stated clearly that federal promulgation is not their preferred approach and recommends that states should develop nutrient criteria that fully reflect localized conditions and protect specific designated uses. This is also Tennessee's preferred approach.

EPA has stated a willingness to provide states with some flexibility concerning the parameters or constituents that provide the basis for criteria development. Causative factors are the pollutants such as nitrogen or phosphorus that stimulate excessive biomass. Response factors are measurements of the effects of the excess nutrients, such as elevated chlorophyll *a* levels, reduced water clarity or an adverse alteration in the benthic community composition. EPA has recommended that states base criteria on both causative and response factors, although EPA has acknowledged that approaches that emphasize one set of factors over another can be acceptable. Tennessee's nutrient criteria development process focuses on both cause and response variables and will continue to do so for all waterbody types.

III. TENNESSEE'S WADEABLE STREAM NUTRIENT CRITERIA DEVELOPMENT

For wadeable streams, Tennessee has selected an approach to criteria development that blends recommendations from EPA with the state's own primary research into nutrient levels in various parts of the state. In fact, when the national nutrient strategy document was developed in 1998, Tennessee was already several years into a project studying water quality at carefully selected reference streams.

The Tennessee Ecoregion Project began in 1993 when Tennessee, with the help of 104(b)(3) funds, arranged for James Omernik and Glen Griffith from the EPA National Health and Environmental Research Laboratory to subregionalize and update the national Level III ecoregions that were developed in 1986.

During the delineation process, maps containing information on bedrock and surface geology, soil, hydrology, physiography, topography, precipitation, land use and vegetation were reviewed. Interagency cooperation widened the base of maps, information and resources available to delineate subregions. Much of this information was digitized to produce draft maps of ecoregion and subregion boundaries.

Multiple agencies were represented at three ecoregion meetings held during 1994-95. Attendees included aquatic biologists, ecologists, foresters, chemists, geographers, engineers, university professors and regulatory personnel from 37 state and federal agencies as well as universities and private organizations. The judgment of these experts was applied throughout the selection, analysis and classification of data to determine the final ecoregion and subregion boundaries in Tennessee (Griffith, 1997).

Ecoregion delineation culminated in 1997 with the publication of a map outlining 25 Level IV ecoregions (Figure 3).

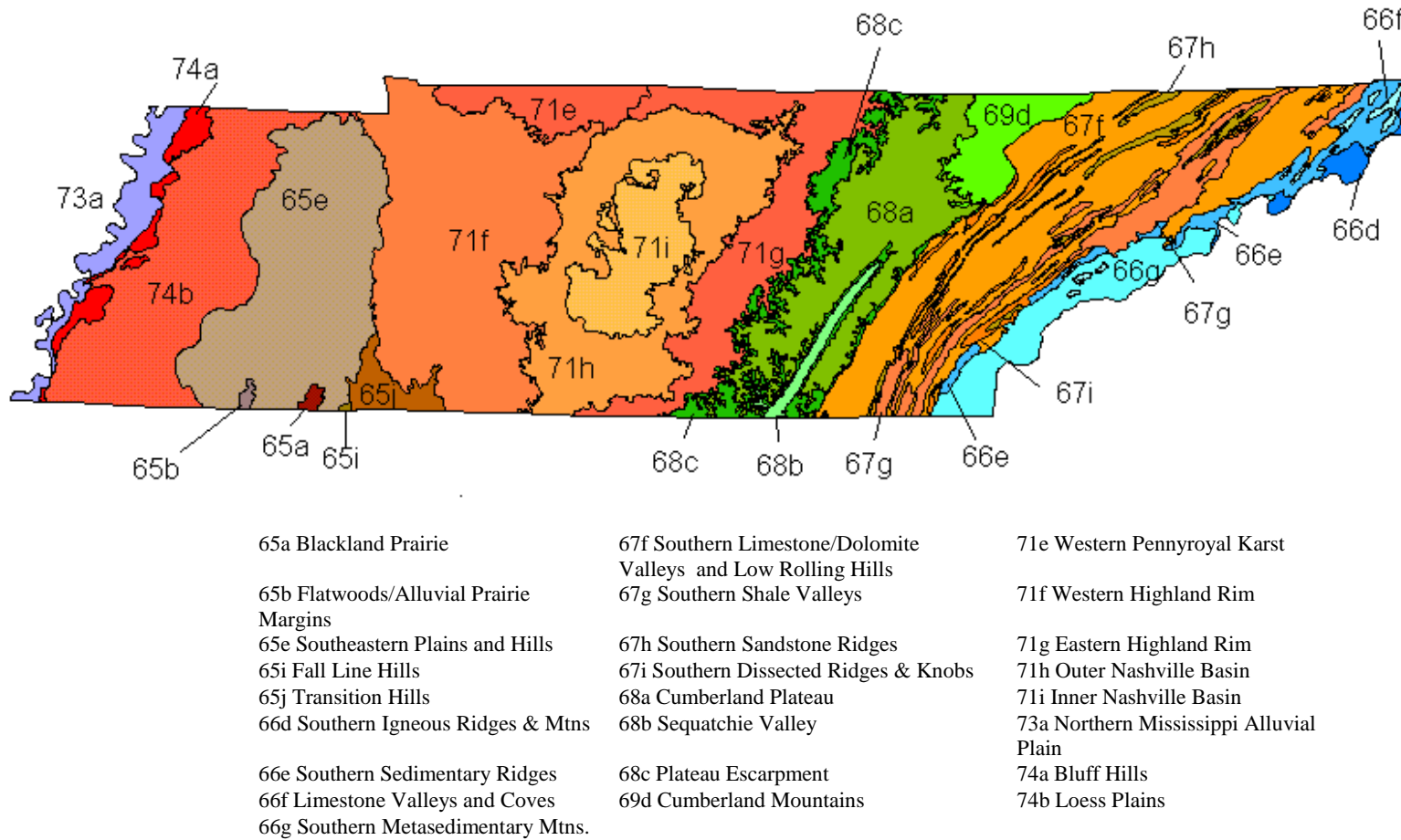

Figure 3: Level IV ecoregions of Tennessee

In parallel with the delineation efforts, in 1994, work began to identify reference streams throughout the state (Arnwine et al, 2000). Reference streams were least impacted, but representative, waterbodies in each of the subcoregions. Candidate reference streams were selected based on land-use and the general absence of land-disturbing activities. Candidate streams were initially surveyed and approximately 100 were selected for intensive monitoring. Except for some of the very small subcoregions, three to five reference streams were established in each area.

For the next three years, the division intensively monitored each reference stream for physical, biological, and chemical characteristics. Total phosphorus and nitrate+nitrite data were included in these analyses, however, total nitrogen was not. Reference sites have continued to be sampled since then, but in conjunction with the watershed cycle, rather than intensively as before.

In 2001, the division published a document entitled, *Development of Regionally-based Interpretations of Tennessee's Narrative Nutrient Criterion* (Denton et al, 2001). The report:

1. Documented the 75th and 90th percentiles of the total phosphorus and nitrate+nitrite data from each subcoregion.
2. Identified adjoining Level IV subregions that could be combined due to the lack of a statistically significant difference in the data from each.
3. Tested both the 75th and 90th percentiles with the benthic community survey results at test sites to see how well each potential criteria level predicted biological impairment.
4. Proposed the 90th percentile as the basis for clean water goal setting.
5. Established an implementation procedure for application of the narrative criteria.

In 2002, the division formally proposed to the Water Quality Control Board that the total phosphorus and nitrate+nitrite targets based on the 90th percentile established in the 2001 nutrient document be promulgated as water quality criteria. Additionally, the division suggested that a narrative nutrient criterion for protection of the recreational use be adopted. The following language was suggested:

The waters shall not contain nutrients in concentrations that stimulate aquatic plant life and/or algae growth to the extent that the public's recreational uses of the stream or other downstream waters are detrimentally affected.

The set of revisions was drafted and rulemaking procedures were initiated.

In the spring of 2003, a court case challenged the division's ability to identify nutrient-impaired waters and to set permit limitations for nutrients, due to the lack of a water quality criterion specific to that condition. In response, the Board approved an emergency rule for nutrients. The emergency rule, which was narrative in nature, stated:

(m)The waters shall not contain nutrients in concentrations that stimulate aquatic plant and/or algae growth to the extent that aquatic habitat is substantially reduced and /or the biological integrity fails to meet regional goals. Additionally, the quality of downstream waters shall not be detrimentally affected.

Interpretation of this provision may be made using the document Development of Regionally-based Interpretations of Tennessee's Narrative Nutrient Criterion and/or other scientifically defensible methods.

The wording of the emergency rule did several significant things. First, as part of the criteria for protection of fish and aquatic life, it applied to all waters, since all waters in Tennessee have that designated use assigned to them. Since the criterion was non-specific, it applied to all waterbody types and established the importance of physical (habitat) and biological data in interpreting the criterion. Additionally, for wadeable streams, it established the division's procedure based on reference stream data, as the preferred method of interpretation. This emergency rule, once promulgated, was then approved by EPA in December, 2003.

In August, 2003, EPA raised concerns about the promulgation of numeric criteria based on the 90th percentile of the reference stream data. Additionally, the public and the regulated community did not appear to support numeric criteria. In response, the division removed the proposed numeric criteria and substituted the narrative criterion language from the emergency rule.

All the proposed revisions to water quality standards were promulgated by the Board in September, 2003. Following certification by the Attorney General's office, the rulemaking hearing rules were transmitted to EPA. The state rulemaking process was completed in January, 2004. In September 2004, EPA formally approved almost all of Tennessee's revisions, including the narrative nutrient criterion. (As stated previously, EPA had already approved the same language in the emergency nutrient criterion.)

There are several reasons that Tennessee chose not to use EPA's national nutrient criteria recommendations for wadeable streams. The first and most obvious is that EPA stated a preference that states develop their own regionally-based nutrient criteria. The national database used by EPA included data from large rivers and streams that crossed Level IV (and sometimes Level III) ecoregion boundaries. Tennessee's reference database was restricted to streams that had at least 80% of the upstream drainage included within the targeted Level IV subregion.

A Level IV or ecological subregion approach is much more refined and indicative of local conditions. Subregions in Tennessee were often statistically different from other subregions in the same Level III ecoregion. Basing criteria on Level III data is not sensitive to obvious regional differences.

Another source of concern about EPA's national nutrient criteria recommendations is that a statistical approach was used to derive the national criteria without consideration of cause-effect relationships. Tennessee has utilized an approach that incorporates not only the identification of the reference condition, but also considers the effects of nutrient enrichment to the biological community. The state considers this approach a more appropriate method of determining nutrient thresholds for the protection of designated uses.

Regarding other waterbody types such as lakes and reservoirs, Tennessee is not certain that an ecoregional framework will be as helpful as it was with rivers and streams. Although Florida used such an approach for their lakes, most of their lakes are of natural origin, while most of Tennessee's are impoundments. The characteristic of reservoirs seem to be more controlled by the size and type of dam, the contours of the flooded valley, retention times, and inflow and outflow rates.

IV. CLASSIFICATION BY WATERBODY TYPE

As previously stated, all waterbody types in Tennessee are currently covered by the state's EPA-approved narrative nutrient criterion. Under this rule, a methodology for interpreting the criterion in wadeable streams is specified. In order to continue development of more specific nutrient criteria, groups need to be identified for the various waterbody types. Classification refers to the way waterbodies can be grouped for criteria development.

Tennessee plans to classify waterbodies in the following manner:

Streams and Rivers

Wadeable Streams

For nutrient criteria purposes, these waters have also been grouped by nutrient regions (total phosphorus and nitrate+nitrite) based on statistical similarity between reference data in the Level IV ecological subregions (Figures 4 and 5). From the 25 Level IV subregions in Tennessee, nutrient regions have been grouped into 15 nitrate+nitrite and 15 total phosphorus. Although both groups have 15 regions, they do not exactly overlap.

Reference conditions have not yet been established for wadeable streams that cross more than one nutrient region. However, the majority of the state's wadeable streams are covered. If a stream crosses more than one region, a decision is made on which region has the most influence on the stream flow and the criterion for that region is used.

The wadeable stream criteria are used in conjunction with regional biocriteria for a cause and effect approach. Macroinvertebrates were selected as the principal indicator of nutrient enrichment although algal density is also considered when assessing streams. Tennessee selected macroinvertebrates rather than periphyton as a nutrient indicator in wadeable streams because of the state's existing expertise and large reference database. Shifts in the macroinvertebrate community such as an increase in the abundance of nutrient tolerant organisms, an increase in filterers and scrapers, an increase in worms and midges and a decrease in EPT taxa are generally measured in nutrient enriched waters. These changes are generally a response to an increase in algal growth which results in dissolved oxygen depletion, loss of habitat and a shift in available food types.

In 2008 through 2016, Tennessee used 106 supplemental grant funds for nutrient criteria development in headwater streams with less than 2.6 square mile drainage. The project mirrored the wadeable stream ecoregion project with selection and monitoring of 87 headwater reference streams in 23 ecoregions. A separate macroinvertebrate index calibrated to headwater streams was published in 2017.

The division recognizes the value of periphyton as an additional nutrient indicator. In 2017 Tennessee partnered with Georgia, Kentucky and Alabama to combine diatom data to develop a southeast regional diatom index sensitive to nutrients. The data are currently being analyzed by Tetrtech through EPA funding.

Non-wadeable streams and rivers

It is likely that Tennessee will continue to use the ecoregion approach to establish nutrient criteria in these systems. Cause-effect relationships between nutrient concentrations and macroinvertebrates, and possibly fish and algae, will be explored. Nitrate+nitrite, total phosphorus, turbidity and suspended solids data will also be analyzed. The first challenge will be to try and target reference reaches on these large systems. A review of TVA's fixed station monitoring has begun. Data from other sources has been requested.

Reference conditions have been established for non-wadeable waters in ecoregions 74b and 73a (for both nitrate+nitrite and total phosphorus). Reference streams have not been established for non-wadeable flowing water in other regions or for those waters that cross multiple subregions. Four potential reference sites were targeted and monitored as part of a 104(b)(3) grant in summer 2004 for rivers and large streams crossing ecoregions 65e and 74b in west Tennessee (Arnwine et. al, 2005).

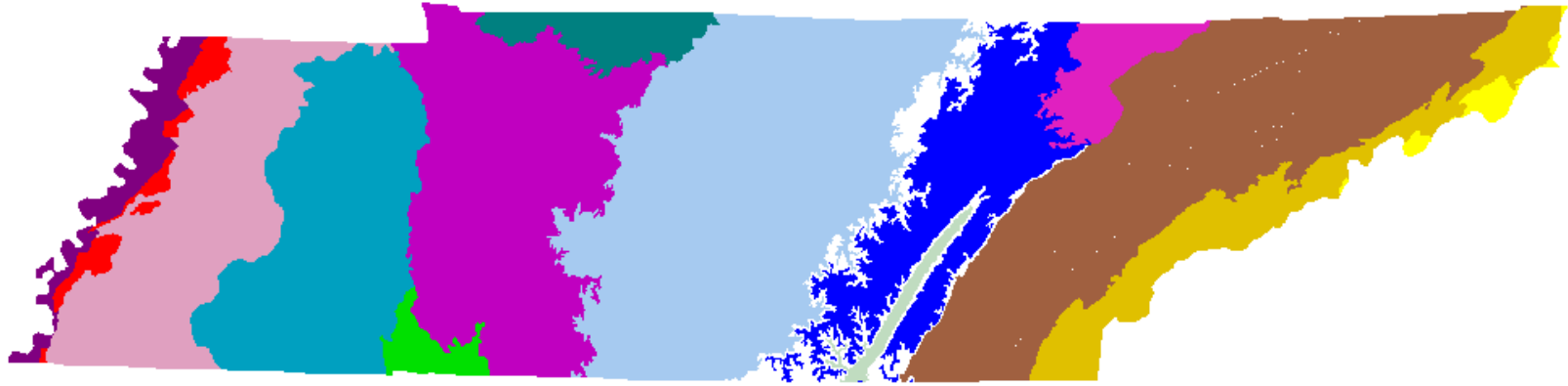

Figure 4: Nitrate+Nitrite regions for wadeable streams in Tennessee



Figure 5: Total phosphorus regions for wadeable streams in Tennessee

Lakes and Reservoirs

Tennessee has initiated development of specific nutrient guidelines for lakes and reservoirs beginning with a review of existing data. For the initial review of data, lentic systems were divided into the following broad categories. It is possible they will be further divided into sub-categories or that small and medium reservoirs will be grouped. It is likely that an approach that focuses on lake management and retention times will need to be used for larger reservoirs that are managed for power production or flood control. It is possible the ecoregion approach may be used for smaller reservoirs that are contained within a single bioregion and are not routinely drawn down or fertilized to promote fish production. Criteria development will focus first on large reservoirs since they have more available data and are heavily used for recreation.

Natural Lakes

Many of Tennessee's significant natural lakes are in West Tennessee, especially along the Mississippi River in the Alluvial and Loess Plains ecoregions. It is often, but not correctly, said that Reelfoot Lake is Tennessee's only natural lake. Reelfoot Lake is by far the largest at 10,950 acres. The other natural lakes are well under 250 acres in size. While it might be possible to have an ecoregional basis for these small natural lakes, the problem in West Tennessee would be that the significant amount of agricultural land conversion and extensive hydrological modification (leveeing and channelization of tributaries) would make it difficult to find suitable reference sites. However, 16 small natural lakes located in wildlife refuges and state natural areas in these two ecoregions may provide baseline information. A representation of these lakes will be monitored when federal support makes staffing and money. It may also be possible that neighboring states may have reference quality lakes in this subregion.

Extensive water quality investigations were conducted at Reelfoot Lake in the 1980s (TDHE, 1984 and Denton, 1987). This lake is already listed as nutrient impaired due to elevated chlorophyll *a* levels and nuisance aquatic plants. The dense stands of aquatic plants interfere with recreational boating.

Large Reservoirs (> 1000 acres)

Tennessee has 29 large reservoirs over one thousand acres. They range in size from the 1,749 acre Chilhowee Reservoir on the Little Tennessee River to the 99,500 acre Kentucky Lake on the Tennessee River. Twenty-seven of these reservoirs are managed by the Tennessee Valley Authority (TVA) or the U.S. Army Corps of Engineers (USACE). Chilhowee is managed by Alcoa Aluminum and Woods is managed by US Air Force's Arnold Engineering Development Center. All but four of these large reservoirs are routinely monitored by the management agency. Six are shared with other states including Kentucky Lake, Lake Barkley and Dale Hollow (Kentucky); South Holston Lake (Virginia); Guntersville Lake (Alabama); and Pickwick Lake (Alabama and Mississippi). Expertise and data are available from all these sources and will be useful as part of the criteria development process. In the 2006 water quality standards, Tennessee adopted nutrient criteria for Pickwick Lake based on Alabama's criteria and monitoring stations in Tennessee.

Medium Reservoirs (251 – 1000 acres)

Tennessee has 16 reservoirs falling in this category. Five are fishing lakes managed by the Tennessee Wildlife Resources Agency (TWRA). Reelfoot-Indian Creek #1 was one of 10 reservoirs that was constructed to control sediment transport into Reelfoot Lake and is now managed as a recreational lake by TWRA. Eight of the reservoirs are managed by TVA, mostly for flood control. Three of these are routinely monitored as part of TVA's Vital Signs Monitoring Program. Calderwood is managed by Alcoa Aluminum for power production. Meadow Park Lake, is a water supply reservoir for the city of Crossville on the Cumberland Plateau. A factor to consider is that the TWRA impoundments are fertilized to promote fish production and are periodically drained. While the Division of Water Resources has strong reservations about this practice, it may be that criteria in these fishing reservoirs need to focus more on the protection of downstream reaches, rather than prevention of over enrichment in the reservoir water column.

Small Reservoirs (< 250 acres)

Tennessee has 1,302 documented reservoirs under 250 acres (Figure 6). This number only includes reservoirs that were permitted under the Safe Dams or ARAP (Aquatic Resources Alteration Permit) programs. There are probably many more. The documented reservoirs include one TVA managed reservoir (Wilbur Lake), municipal lakes, state parks, city parks, resorts, community developments, agricultural ponds and private lakes. There is little historic data on many of these impoundments. The studies that have been done indicate that many of these lakes are eutrophic. It is possible that an ecoregion approach can be used on these lakes since they are generally contained in one ecological subregion although lake management will need to be a consideration.

Wetlands

Tennessee has approximately 787,000 acres of wetlands. The Division has identified 54,811 impacted wetland acres. The largest single cause of impact to existing wetlands is loss of hydrologic function due to channelization and leveeing.

Wetlands are currently covered under the general narrative nutrient criteria. Tennessee does not have the resources or data available for development of wetland specific nutrient criteria. Protection and restoration of wetlands from physical alterations has historically been considered a higher priority.

Tennessee was one of the first states in the nation to have a wetlands protection strategy and has been recognized by EPA as establishing a national model for wetlands planning. Wetland nutrient criteria will be considered after nutrient criteria for flowing waters and reservoirs are established and federal assistance for monitoring and criteria development is provided.

V. CRITERIA DEVELOPMENT APPROACH BY WATERBODY TYPE

The focus of Tennessee's nutrient criteria strategy is based primarily on the linkage between nutrient concentrations and impairment of designated uses. Both causative variables such as phosphorus and nitrate+nitrite as well as response variables such as the health of the macroinvertebrate community, algal populations and chlorophyll *a* levels are taken into consideration. The establishment of nutrient criteria has been and will continue to be founded on the results of comprehensive cause and effect-based study and analysis for all waterbody types.

Wadeable Streams

Tennessee has been researching nutrient levels in wadeable streams since 1995 and has used these data to develop nutrient criteria as outlined in the document *Development of Regionally-Based Interpretations of Tennessee's Narrative Nutrient Criterion*, (Denton et al, 2001). This document is referenced as a translator (along with other scientifically defensible data) in Tennessee's narrative nutrient criterion, which became a state rule in January 2004. The nutrient criterion is tied-in with the biological criteria for an effects-based approach.

The guidelines are based on data collected primarily from 1996 to 1999, consisting of chemical, physical and biological samples collected in least-impacted, yet representative, streams in 25 Level IV ecological subregions across the state. Data continues to be collected from these streams on the five-year watershed cycle. Several studies have been conducted to develop and refine the regionalized nutrient criteria guidelines.

Ecoregion Reference Stream Study

Three hundred and fifty-three potential reference sites were evaluated as part of the ecoregion project. The reference sites were chosen to represent the best attainable conditions for all streams with similar characteristics in a given subregion. Reference conditions represented a set of expectations for physical habitat, general water quality and the health of the biological communities in the absence of human disturbance and pollution.

Selection criteria for reference sites included minimal impairment and representativeness. Streams that did not flow across subregions were targeted so the distinctive characteristics of each subregion could be identified. Based on EPA recommendations, three reference streams per subregion were considered the minimum necessary for statistical validity. Only two streams could be found in some smaller subregions. Seventy streams were targeted for intensive monitoring beginning in 1996. After analysis of the first year's data, it was determined that a minimum of five streams per subregion would be more appropriate. Where possible additional reference streams were selected for monitoring. However, in smaller subregions or those with widespread human impact this was not feasible. Forty-four reference streams were added to the study resulting in intensive monitoring at 114 sites beginning in fall 1997. There were between two and eight reference streams targeted in each subregion.

All reference sites were monitored quarterly for three consecutive years. Since 1999, sites have been monitored quarterly as part of the five year watershed cycle. New reference sites are added as they are located during watershed or probabilistic monitoring. Conversely, some of those originally selected have been dropped due to increased disturbances or unsuitability. There are currently 104 active reference sites.

During the nutrient criteria development process, the data were analyzed for relationships between other parameters and nutrient levels at reference streams. Relationships were investigated primarily for turbidity, total organic carbon (TOC) and total suspended solids. Somewhat weak relationships between total organic carbon and turbidity were documented with total phosphorus levels. This study is documented in the USEPA report (EPA-822-B-00-002, Appendix A). These relationships will continue to be analyzed as more data become available.

Nutrient concentrations were compared between each subregion to determine groupings for nutrient regions. Fisher's Protected Least Significant Difference at significance level of 5% was used to determine which subregions could be combined. Reference data from the Alabama Department of Environmental Management was used to support pooling of small subregions in the Southeastern Plains (65).

Tennessee's regional nutrient guidelines were set at the 90th percentile of reference data for each region (Denton et al 2001). Since Tennessee is using causal responses based on macroinvertebrate communities to define nutrient criteria violations, both the 90th and 75th percentile of reference data were evaluated for criteria development. Relationships between biological stream health and nutrient concentrations were explored using reference stream data, probabilistic data, and data from targeted monitoring.

Based on a comparison to biocriteria guidelines throughout the state, the 75th percentile often targeted streams as nutrient enriched that showed no biological impairment. Therefore, regional nutrient criteria were proposed for both NO₂+NO₃ and total phosphorus at the 90th percentile of reference data.

In 2006, biological data were once again compared to the 90th and 75th percentile of regional reference data and EPA's nutrient criteria recommendations to evaluate which level had the best match for cause and effect (Figure 6). Ninety six sites where the macroinvertebrate community passed regional guidelines and both nitrate+nitrite and total phosphorus samples had been collected were used in the evaluation. For both nitrate+nitrite and total phosphorus, the 90th percentile of Tennessee's ecoregion reference had the clearest relationship with biological integrity. At sites where the macroinvertebrate community did not respond to nutrients above the 90th percentile, the stream was well-shaded or there were other factors that would retard algal growth.

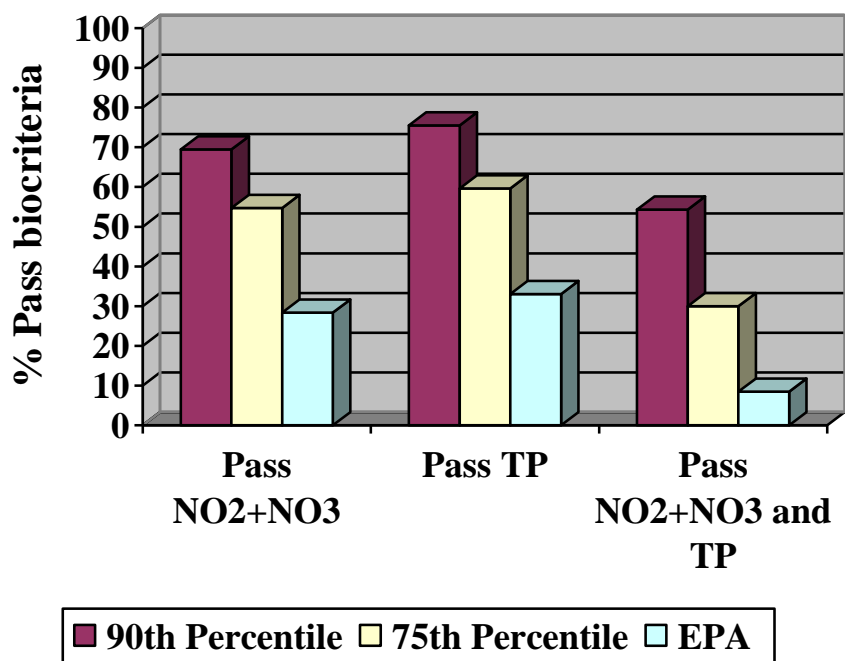

Figure 6: Comparison of sites supporting biological integrity with proposed nutrient criteria at 75th and 90th percentiles of reference data and EPA recommended nutrient criteria.

At the time the guidelines were published in 2001, 916 data points from reference streams were used to calculate regional criteria guidelines for total phosphorus and nitrate+nitrite at the 90th percentile. Values are checked annually using additional data collected from reference sites through the year (Tables 3 and 4). In 2007 there were twice as many data points. There has been very little change over the last five years indicating that the criteria are an accurate reflection of background levels in each region.

Tennessee intends to continue to investigate nutrient levels at reference and test sites. However, the division is satisfied that guidelines set at the 90th percentile using regional reference data are appropriate and can be justified. The fourteen years of research and eleven years of data collection used to establish these regional guidelines indicate that the 90th percentile is a better predictor of biological impairment in Tennessee ecoregions than the EPA's guidelines based on the 25th percentile of aggregated Levels III data or the 75th percentile of Tennessee data.

After several years' experience, the division has found the use of numeric translators of the nutrient criteria in conjunction with biocriteria to be an effective tool for assessments while providing flexibility to use more stringent numbers for TMDLs. Tennessee will continue to refine and test implementation of the narrative nutrient criteria with numeric translators. The state will consider the possibility of promulgating the translators as numeric criteria depending on EPA's progress toward developing categorical permit limits and providing further clarification about implementation of numeric criteria including the incorporation of biological response criteria.

Table 3: 90th and 75th percentile of reference total phosphorus data by ecological subregion (mg/L)

August 2001 N = 916				September 2007 N = 1835			
Grouped Subregions	90 th	75 th	Count	Grouped Subregions	90 th	75 th	Count
73a	0.25	0.19	19	73a	0.32	0.23	57
74a	0.12	0.11	28	74a	0.17	0.11	55
74b	0.10	0.06	42	74b	0.12	0.06	91
65a, 65b, 65e, 65i	0.04	0.04	74	65a, 65b, 65e, 65i	0.10	0.04	142
65j	0.04	0.01	53	65j	0.04	0.01	81
71e	0.04	0.02	38	71e,	0.04	0.03	69
71f, 71g	0.03	0.02	112	71f, 71g	0.05	0.02	254
71h, 71i	0.18	0.10	105	71h	0.09	0.06	94
71i				71i	0.24	0.13	152
68a, 68c	0.02	0.01	101	68a, 68c	0.03	0.01	212
68b	0.04	0.03	31	68b	0.08	0.04	50
69d	0.02	0.01	50	69d	0.03	0.01	102
67f, 67h, 67i	0.04	0.02	72	67f, 67h, 67i	0.04	0.02	217
67g	0.09	0.06	25	67g	0.09	0.05	54
66d, 66e, 66g	0.01	0.01	114	66d, 66e, 66g	0.02	0.01	252
66f	0.02	0.02	22	66f	0.03	0.02	53

Table 4: 90th and 75th percentile of reference nitrate+nitrite data by ecological subregion (mg/L)

August 2001 N = 885				September 2007 N = 1834			
Grouped Subregions	90 th	75 th	Count	Grouped Subregions	90 th	75 th	Count
73a	0.39	0.26	19	73a	0.35	0.24	59
74a	0.22	0.15	27	74a	0.25	0.15	53
74b	1.19	0.72	42	74b	1.04	0.56	91
65a, 65b, 65e, 65i	0.34	0.25	74	65a, 65b, 65e, 65i,	0.32	0.25	142
65j	0.22	0.19	53	65j	0.25	0.22	82
71e	3.48	3.11	37	71e	3.69	3.12	70
71f	0.38	0.19	69	71f	0.38	0.25	175
71g, 71h, 71i	0.94	0.64	148	71g, 71h, 71i	0.93	0.67	325
68a	0.23	0.13	73	68a	0.22	0.12	153
68b	0.45	0.33	31	68b,	0.48	0.36	50
68c	0.31	0.25	28	68c	0.34	0.29	59
69d	0.27	0.16	50	69d	0.27	0.16	100
67f, 67g, 67h, 67i	1.22	0.95	97	67f, 67g, 67h, 67i	1.12	0.88	272
66d	0.50	0.22	32	66d	0.52	0.29	92
66e, 66f, 66g	0.31	0.21	105	66e, 66f, 66g	0.30	0.21	213

The use of regional reference data follows EPA's recommendation that states establish localized guidelines when possible. The use of the 90th percentile meets Tennessee's desire to base nutrient guidelines on a cause and effect relationship rather than a purely statistical approach and is consistent with both Tennessee's and EPA's goals to protect designated uses. Past concerns EPA has expressed with Tennessee's approach have been considered and are addressed in Appendix A.

Tennessee is performing many studies relating to nutrient enrichment as described in the next section. These studies are expected to enhance the understanding of the effects of nutrient enrichment on streams. However, Tennessee feels that the regional nutrient guidelines at the 90th percentile in conjunction with documentation of macroinvertebrate assemblages is an effective way to assess nutrient impairment and intends to go forward with this as the primary approach.

Inner Nashville Basin Probabilistic Monitoring Study

In 2001, 104(b)(3) grant monies were awarded to extend a probabilistic study of water quality in the Inner Nashville Basin (ecoregion 71i). The focus of this phase of the study was to explore the relationship between nutrient levels and the biological community (Arnwine et. al., 2003). The metric with the strongest response to total phosphorus was EPT richness (Figure 7). The percent chironomids and oligochaetes (%OC) was the biometric most affected by nitrate+nitrite concentrations (Figure 8).

The relationships between nutrients and macroinvertebrate biometrics were strengthened when percent canopy was included as a variable (Tables 5 and 6). Data show the absence of canopy played a significant role in the response of macroinvertebrates to elevated nutrient levels.

This study has resulted in percent canopy measures routinely being added to biological surveys. When possible, periphyton abundance is also measured, especially if nutrients are a concern. Due to manpower, expertise and funding constraints, it is unlikely Tennessee will include periphyton surveys requiring taxonomic identification as a regular survey activity although it may be included in special projects.

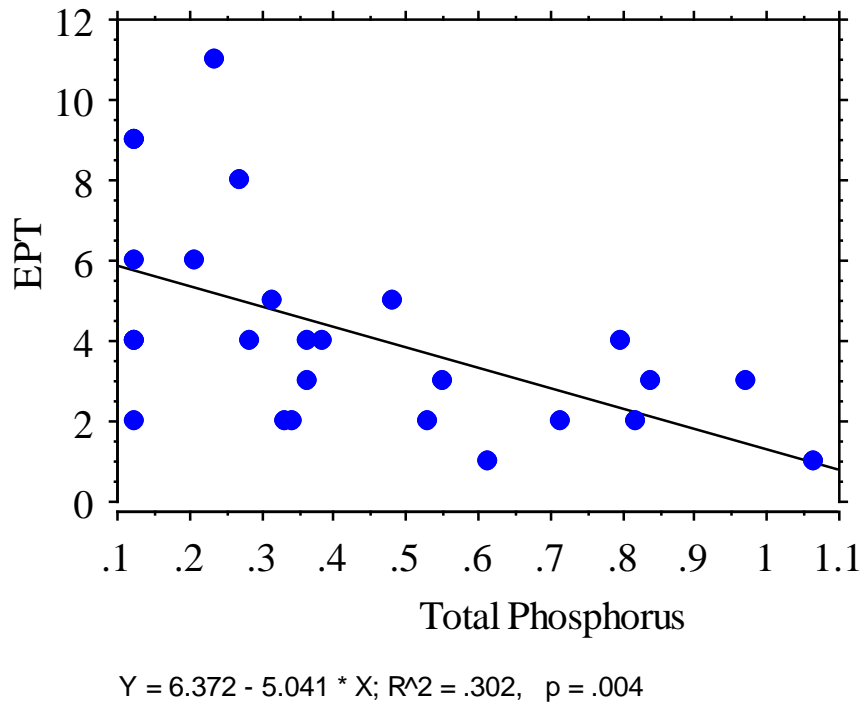

Figure 7: Relationship between total phosphorus levels and EPT taxa richness during low flow conditions. Data represents 21 probabilistic monitoring sites and two ecoregion reference sites in the Inner Nashville Basin.

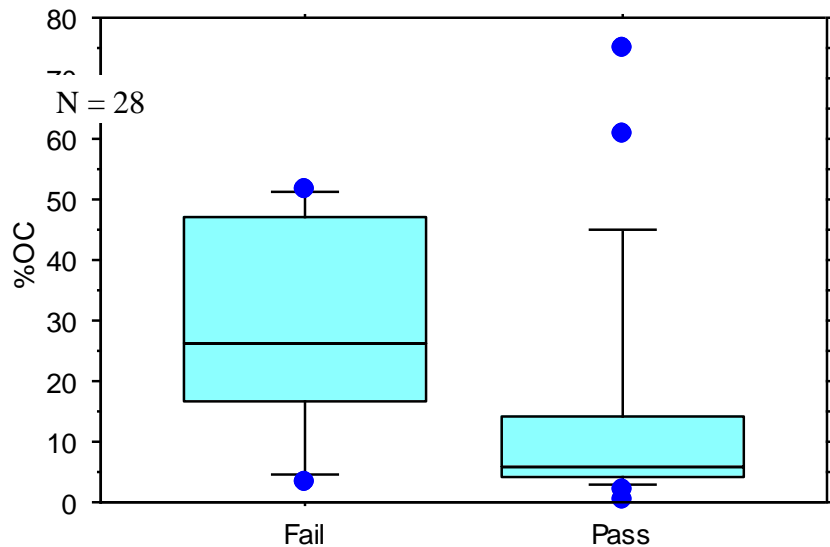

Figure 8: Distribution of Oligochaeta and Chironomidae abundance at sites with nitrate+nitrite levels above (fail) and below (pass) regional guidelines. Data represent 21 probabilistic sites and two ecoregion reference sites collected in fall 2000 in the Inner Nashville Basin.

Table 5: Relationship (adjusted R²) between nutrient levels and nine biometrics at 50 test sites and two reference sites. Values in bold p < 0.05.

Biometric	Fall			Spring		
	NO2-3	TP	NO2-3 TP	NO2-3	TP	NO2-3 TP
Count	26	26	26	101	101	101
TMI	-.001	-.086	.010	-.001	+.025	.005
TR	+.049	-.014	..057	-.006	+.012	.016
EPT	+.071	-.302	.283	-.002	+.004	.005
%EPT	-.149	-.016	.110	+.004	+.00003	.004
%OC	+.190	+.004	.137	+.003	+.025	.011
NCBI	-.042	+.117	.067	-.020	-.011	.015
%DOM	-.005	+.002	.006	+.001	-.036	.016
%CLING	+.009	-.133	.060	-.002	-.091	.073
%NUTOL	+.221	+.009	.186	-.003	+.013	.015

Table 6: Relationships (adjusted R²) between nutrient levels, canopy cover and nine biometrics. Samples collected at 50 probabilistic monitoring sites and two reference sites. Values in bold are statistically significant (p < 0.05)

Bio-metric	Fall				Spring			
	Canopy	CanopyN O2-3	CanopyT P	Canopy NO2-3 TP	Canopy	CanopyN O2-3	CanopyT P	Canopy NO2-3 TP
Count	16	16	16	16	92	90	90	90
TMI	+.243	.161	.566	.549	+.007	.007	.013	.002
TR	+.080	.082	.084	.017	+.012	.001	.031	.023
EPT	+.053	.058	.280	.237	-.022	.017	.002	.025
%EPT	+.039	.143	.078	.103	-.021	.002	.018	.026
%OC	+.027	.567	.131	.615	-.046	.036	.057	.064
NCBI	-.180	.054	.417	.373	+.087	.108	.089	.108
%DOM	-.030	.033	.125	.126	+.001	.002	.028	.019
%CLING	+.221	.133	.641	.626	-.018	.006	.055	.078
%NUTOL	+.001	.018	.082	.062	-.016	.015	.016	.017

2006 Update of Tennessee Macroinvertebrate Index for Wadeable Streams

In 2006, the state revised the Tennessee Macroinvertebrate Index as part of the annual Quality System Standard Operating Procedure (QSSOP) review and the triennial review of Water Quality Standards. In an effort to make the index more sensitive to nutrient and sediment impairment, the percent dominant taxon metric was replaced with the percent nutrient tolerant metric presented in a paper on determining nutrient impairment using biological and other non-chemical indicators in Kentucky (Brumley et al, 2003).

The metric combines 14 taxa that were frequently found in streams containing elevated total phosphorus (TP) and nitrogen (TN). In order for taxa to be selected, they individually comprised a minimum of >5% of the total number of individuals in the sample. The %NUTOL was significantly ($p < 0.0001$) correlated with increasing TN, TP, and the interaction term (Pearson's $r = 0.48, 0.58, \text{ and } 0.59$, respectively). During the Southeast Water Pollution Biologist Association annual meeting in 2005, Kentucky biologists indicated the metric was a better indicator of sedimentation. The seven taxa included *Cheumatopsyche*, *Lirceus*, *Physella*, *Baetis*, *Psephenus*, *Stenelmis*, *Simulium*, *Elimia*, *Oligochaeta*, *Polypedilum*, *Rheotanytarsus*, *Stenacron*, *Cricotopus* and *Chironomus* spp. With the exception of *Stenacron*, and *Psephenus*, these taxa are often abundant in nutrient enriched streams in Tennessee.

In 2003, WPC began calculating this metric on all semi-quantitative macroinvertebrate samples to determine if the metric was more sensitive than the percent dominant metric to various levels of impairment. It had been observed by the division's biologists that the percent dominant was generally only sensitive in cases of severe impairment, although it is also considered a nutrient indicator.

Although the biological assessment would not change at most of the sites where the index score was lowered, the use of the %NUTOL would enable the division to pick up more subtle changes in the benthic community. This would help biologists keep track of which sites may have begun degrading or were starting to show improvement. The use of this metric would also help in determination of causes of impairment. Sites meeting nutrient and sediment guidelines generally scored a 6 (highest possible score) in %NUTOL (Figure 9).

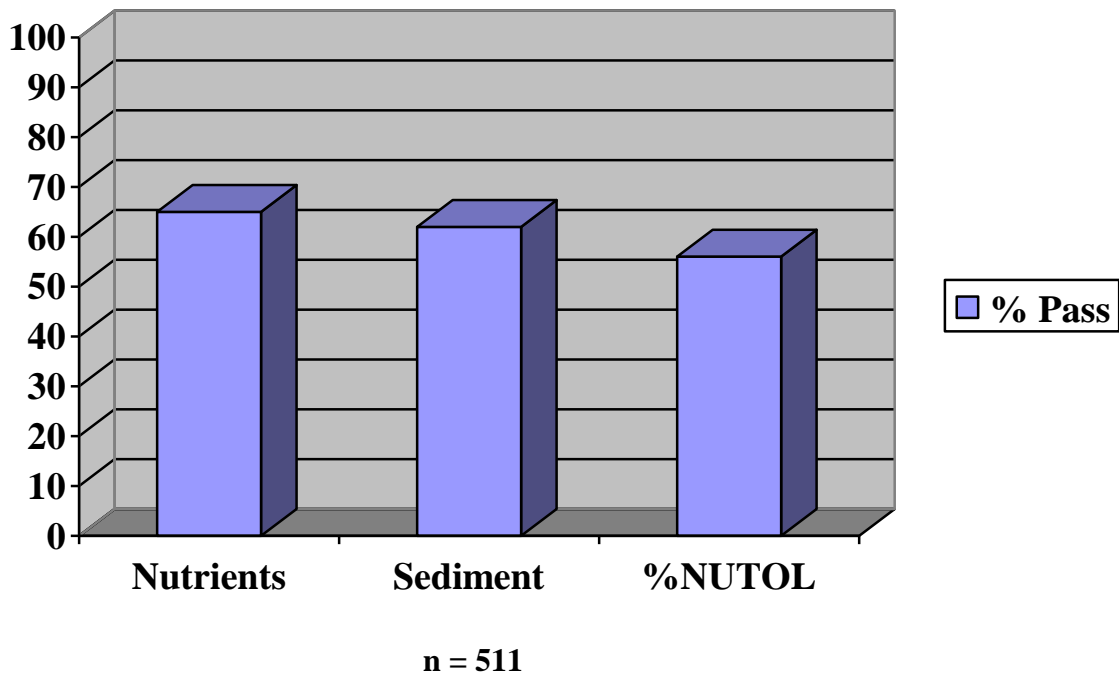

Figure 9: Comparison of samples passing regional nutrient and/or sediment guidelines to samples scoring a 6 in %NUTOL metric.

2017 Update of Tennessee Macroinvertebrate Index for Wadeable Streams.

In 2017 Tennessee adjusted the multi-metric index for streams in the Mississippi Alluvial Plain (ecoregion 73). Streams in this area are slow-moving with sandy bottoms. There are no Plecoptera and few intolerant taxa found in these streams which caused difficulty with the sensitivity of two metrics used in the TMI; EPT and Intolerant taxa. In 2017 these metrics were replaced in this ecoregion with ETO (Ephemeroptera, Trichoptera and Odonata) and CRMOL (Crustacea and Mollusca Abundance).

First Order Streams

In 2008 through 2016, Tennessee used 106 supplemental grant funds for nutrient criteria development in headwater streams with less than 2.6 square mile drainage. The project mirrored the wadeable stream ecoregion project with selection and monitoring of 87 headwater reference streams in 23 ecoregions. A separate macroinvertebrate index calibrated to headwater streams was published in 2017.

Periphyton

In 2018 Tennessee formed a workgroup with three other states (Alabama, Kentucky and Georgia), Tetratech and EPA to develop a southeast regional diatom index. The states have combined results from over 1000 flowing stream stations in 60 level 4 ecoregions. The workgroup has almost completed the harmonization process to examine and eliminate, as necessary, variability due to collection method and taxonomy.

The remaining dataset will then be used to evaluate site classification schemes, to include level IV ecoregions. Other factors, such as catchment area, season, and canopy cover, will also be tested. As a final step, site classes with limited samples would be excluded from index development. In addition to identifying site classes for indicator development, this step will assist in future efforts by identifying site classes where more sampling is needed.

Indicator development will be conducted on the priority site classes. Ancillary data, habitat assessment survey results, water quality data, rapid periphyton survey data (percent cover and thickness) will be compiled by the states in a standardized format. Site information, such as land use, will be compiled by the contractor as part of this project. These data will be used to test metrics and indices, and to develop diatom attributes specific to the southeastern United States. Once the index is developed and tested, Tennessee will incorporate periphyton as a second indicator group (along with macroinvertebrates) as a nutrient response.

Non-wadeable streams and rivers

Non-wadeable streams and rivers are covered under the general narrative nutrient criteria for fish and aquatic life in the 2013 water quality standards. Tennessee feels strongly that nutrient criteria should consider the cause/effect relationships. Biological guidelines for non-wadeable streams will be developed at the same time.

Nutrient and biological guidelines have already been developed for non-wadeable streams contained within the Loess Plains ecoregion (74a) and the Northern Mississippi Alluvial Plain (73a) as part of the wadeable streams criteria development. The division intends to collaborate with other resource agencies in the effort to develop regional guidelines for nonwadeable streams and rivers in other ecoregions. While these guidelines are being developed, the state is taking steps to maintain the quality of these downstream waters. Protection of these waters is accomplished through assessments of headwaters, larger feeder streams and upstream wadeable portions that contribute to the nutrient loading of these larger systems, nutrient monitoring and biological sampling in the nonwadeable portions, TMDL development, coordination with the Tennessee Department of Agriculture for BMPs and the addition of nutrient limits and/or monitoring requirements to pertinent discharge permits.

Individuals with expertise in large river water quality from TDEC, TVA, and EPA have been contacted for review of strategies to develop nutrient and biological guidelines in non-wadeable flowing waters. There are three potential strategies for collecting macroinvertebrates. TDEC currently uses rooted bank samples on smaller non-wadeable rivers in west Tennessee but this may not be sufficient in larger rivers or other areas of the state. TVA uses PONAR grabs and has supplied 10 years of macroinvertebrate data from 18 fixed stations. Seven of these are potentially useful as reference sites. Although an extensive amount of water quality data were collected at these sites in the 1980's and early 90's, limited samples have been collected since then. It is likely this method will prove too labor intensive and costly for the state's assessment program. The large river bioassessment protocols being developed by Joe Flotemersch, EPA are also under consideration. Tennessee participated in the national rivers assessment project in 2007. Protocols from this project are also being considered.

One of the difficulties associated with non-wadeable streams and rivers is they often cross Level IV and even Level III ecoregional boundaries. Potential reference reaches in rivers crossing regions 65e and 74b have already been targeted and were monitored as part of a federally funded 104(b) diurnal dissolved oxygen study in 2004 (Arnwine et al, 2005). The reaches selected for study were fully supporting river reaches where existing macroinvertebrate data demonstrated a healthy community, habitat scores were high for the region and water quality data were within acceptable ranges.

Four stations were found to be meeting these guidelines: Hatchie River at mile 80.8, Wolf River at mile 44.4, South Fork Forked Deer River at mile 65.6, and the North Fork Forked Deer River at mile 20.5. These four rivers represent all the major drainages that cross these two subregions, except the Obion and Loosahatchie where potential reference reaches could not be located based on existing data.

The potential reference reaches were monitored for diurnal dissolved oxygen, nutrients, flow, macroinvertebrates, temperature, conductivity and pH. In addition, fluvial geomorphological, canopy and habitat measurements are being taken. For comparison, the same study was conducted at five impaired sites on the Middle Fork Obion, North Fork Forked Deer, South Fork Forked Deer and Loosahatchie Rivers. These sites are also non-wadeable and drain ecoregions 65e and 74b.

Results of the non-wadeable stream monitoring indicated that data were generally not comparable to existing wadeable stream guidelines (Table 7). It is likely that separate biological and nutrient guidelines will need to be developed for these stream types. Additional monitoring will be necessary before this can be accomplished. The division intends to follow up on this as soon as funding and personnel are available for monitoring and laboratory analyses.

Table 7: Comparison of nutrient data from biologically diverse non-wadeable streams in the Southeastern Plains and Hills and the Loess Plains in Tennessee. Data are in mg/l.

	Nitrate+Nitrite (mg/l)	Number of Observations	Total Phosphorus (mg/l)	Number of Observations
65e Guidelines for Wadeable Streams	0.34	42	0.04	42
90 th Percentile Non-wadeable 65e Streams with Good Macroinvertebrate Diversity	0.88	9	0.13	9
74b Guidelines for Wadeable and Non-wadeable Streams	1.19	42	0.11	42
90 th percentile 74b Non-wadeable Reference Stream (1)	0.32	31	0.31	31
90 th percentile Non-wadeable Streams Crossing 65e/74b with Good Macroinvertebrate Diversity	0.64	41	0.28	41

As funding allows, non-wadeable reference reaches will be targeted in other regions. When possible, these will be selected based on existing data. It is hopeful that three to five potential reference sites can be located in each targeted region. Due to the lack of existing data, a minimum of three years of reference stream monitoring will need to be conducted prior to development of preliminary guidelines. (During Tennessee’s wadeable stream criteria development process, EPA recommended ten years of data).

If sufficient sites cannot be located based on existing data, field reconnaissance and screening of water quality and biological parameters will be used to supplement existing data. Since TDEC does not currently have staff or funding available for this activity, monitoring and subsequent criteria development in non-wadeable systems will be dependent on federal funds and/or assistance from other agencies. TVA has already indicated that they will not be able to assist due to an agency moratorium on additional monitoring activities.

Ecoregions and groups of ecoregions that will be targeted for non-wadeable reference monitoring (dependent on federal funding) will be:

- 73a Northern Mississippi Alluvial Plain (completed)
- 74b Loess Plains (completed)
- 65e/74b Loess Plains draining Southeastern Plains and Hills (One year completed, subsequent monitoring dependent on federal funding)
- 65e Loess Plains
- 71f Western Highland Rim (TVA fixed station monitoring on Buffalo River)
- 71f/71h Western Highland Rim draining Outer Nashville Basin
- 71h/71i Outer Nashville Basin draining Inner Nashville Basin
- 71h/71g Outer Nashville Basin draining Eastern Highland Rim
- 71i/71h Inner Nashville Basin draining Outer Nashville Basin
- 67fghi Ridge and Valley (TVA fixed station monitoring and TDEC data are available for the upper Clinch, Powell and North Fork Holston Rivers.) . Note that although the North Fork Holston does not meet recreation uses due to legacy mercury, it supports a diverse benthic community and should not have elevated nutrients.
- 67g/66e/66g Southern Shale Valleys draining the Blue Ridge Mountains: TVA fixed station monitoring available from the Hiwassee River.
- 67f/66g Southern Limestone/Dolomite Valleys and Low Rolling Hills draining Southern Metasedimentary Mountains (TVA fixed station monitoring on French Broad River)
- 66g Southern Metasedimentary Mountains
- 67f/66e Southern Limestone/Dolomite Valleys and Low Rolling Hills draining Southern Sedimentary Ridges
- 66e/66d Southern Sedimentary Ridges draining Southern Crystalline Ridges and Mountains
- 68a/69d Cumberland Plateau draining Cumberland Mountains. (TVA fixed station monitoring data available on the Emory River near Deermont.)

Lakes and Reservoirs

Lakes and reservoirs are covered under the general narrative nutrient criterion for fish and aquatic life established in the 2003 emergency rule and promulgated in the 2004 Water Quality Standards. Tennessee intends to work closely with TVA, USACE, USGS, neighboring states and other agencies to develop more specific reservoir criteria. As with nutrient development in wadeable streams, cause and effect relationships will be used.

Natural Lakes

Reelfoot is the only natural lake larger than 250 acres. As mentioned earlier, extensive water quality investigations were conducted at Reelfoot Lake in the 1980s (TDHE, 1984 and Denton, 1987). This lake is already listed as nutrient impaired due to elevated chlorophyll *a* levels and nuisance aquatic plants. The dense stands of aquatic plants interfere with recreational boating.

The majority of smaller natural lakes are in two ecoregions in west Tennessee. Provided suitable reference lakes can be found, it is likely that the ecoregion reference approach will be applicable to develop nutrient criteria for these lakes. Sixteen small natural lakes located in wildlife refuges and state natural areas in these two ecoregions may provide sufficient baseline information. A representation of these lakes will be monitored when staffing and money are available.

Large Reservoirs (> 1000 acres)

As part of the 2006 triennial review of water quality standards, TDEC has adopted nutrient criterion in a reservoir shared with Alabama, contingent on EPA approval. Pickwick Reservoir includes those waters impounded by Pickwick Dam on the Tennessee River. The reservoir has a surface area of 43,100 acres at full pool, 9,400 acres of which are within Tennessee. The criterion states that the mean of the photic-zone composite chlorophyll *a* samples collected monthly April through September shall not exceed 18 µg/l, as measured over the deepest point, main river channel, dam forebay. Tennessee is exploring the possibility of expanding this criterion to other reservoirs in the lower TN River system and/or using Alabama's methodology to calculate chl-*a* numbers for each reservoir individually. For other large reservoirs, there has been a data search and compilation to target data gaps and monitoring needs. The majority of available data has been provided by TVA and USACE. Data are available on 27 of the 29 reservoirs. There are no current data available on Chilhowee Reservoir, which is managed by Alcoa Aluminum and Woods Reservoir, which is managed by the U.S. Air Force Arnold Engineering Development Center.

TVA conducts vital signs monitoring on 18 of these reservoirs (Dycus and Baker, 2001). Data that may be pertinent to developing nutrient criteria include Secchi disc, temperature, pH, DO, conductivity, chlorophyll, nutrients, TOC, benthic macroinvertebrates and fish. These parameters will be used to help determine if there are reservoirs that can be used to establish a reference condition for nutrient enrichment or to develop reservoir specific criterion.

The U.S. Army Corps of Engineers collects the same data, except fish and macroinvertebrates on the seven lakes they manage in Tennessee. They have macroinvertebrate data on five of these lakes. However, sampling techniques are different from TVA and may not be comparable. It is unlikely that TDEC will use fish assemblages since many of these lakes are stocked and do not have ecologically balanced assemblages. Also, previous comparison studies in impaired systems have shown fish tend to be less sensitive to nutrient enrichment than macroinvertebrates.

The time frame for criteria development will be dependent on data availability, sampling needs, the comparability of biological sampling protocols and how much additional sampling can be provided by TVA and USACE. TVA has already indicated they will not be able to assist with additional monitoring outside of their vital signs monitoring. If the state must collect data, federal funding will be necessary and criteria development may be delayed.

Until these preliminary tasks are accomplished, it is uncertain how lakes and reservoirs will be grouped for criteria development. Although the ecoregion framework will be evaluated, it is unlikely that this classification system alone will be adequate for developing criteria especially in the larger reservoirs. Other factors such as retention times, seasonal management, and depth will have to be considered.

Medium Reservoirs (251 – 1000 acres)

Tennessee has 16 impoundments between 251 and 1000 acres. They include three impoundments routinely monitored by TVA as part of their vital signs monitoring program. The data search showed that additional data are needed on the 13 reservoirs not currently monitored by TVA. Federal assistance will be needed for this activity.

Ecoregion boundaries may be a more useful framework for establishing guidelines in these moderately sized systems. Most are contained within a single ecoregion (or even subregion). It is also possible these can be grouped with the smaller lakes.

Lake management will need to be considered, especially for the five TWRA lakes in this size category that are routinely fertilized to promote game fish production. It is possible that TDEC will use stream data immediately downstream of the impoundments to establish guidelines to insure protection of both systems.

Once data are available, the parameters that will be evaluated include chlorophyll, Secchi readings, turbidity, nutrients, dissolved oxygen and macroinvertebrates. As mentioned previously, fish are considered less appropriate since many of these lakes are stocked and do not have ecologically balanced assemblages. Also, previous comparison studies in impaired systems have shown fish tend to be less sensitive to nutrient enrichment than macroinvertebrates or periphyton.

Small Reservoirs (250 acres or smaller)

Reservoirs less than 251 acres will be treated separately (unless data show these are similar to the moderately sized impoundments). Tennessee has 1,302 documented reservoirs under 251 acres (Figure 10). They include one TVA reservoir, TWRA fishing lakes, municipal lakes, state parks, city parks, resorts, community developments, farm ponds and private lakes. There are many more that are not referenced in any database.

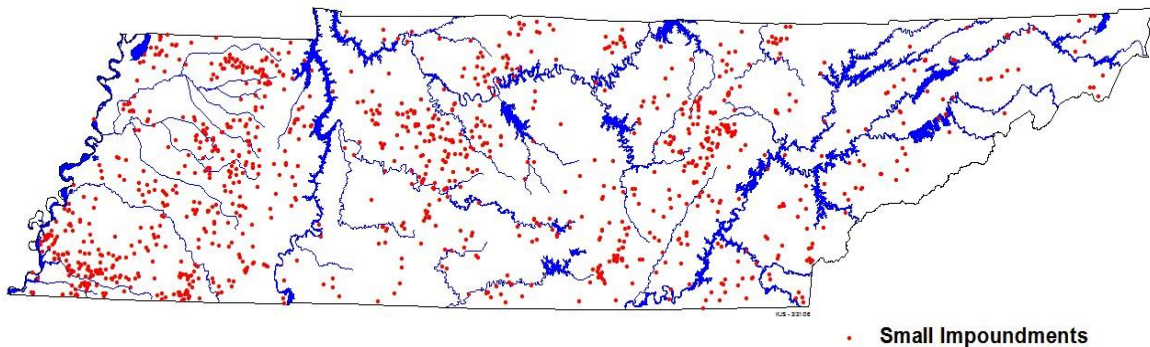

Figure 10: Location of documented impoundments less than 251 acres in Tennessee

None of these small impoundments are routinely monitored although there are some historical data. Although small, these reservoirs are often in headwater areas and have the potential to affect downstream areas. They are generally contained within a single ecological subregion and this approach may be useful for assessment providing suitable references can be found. There are 36 small reservoirs on protected lands (state natural areas, state parks, national forest, state forest, state historic area, national wildlife refuge) that could be monitored to determine if this approach is feasible for establishing baseline conditions (Figure 11).

These reservoirs occur in 15 ecological subregions that represent all bioregions except the Transition Hills (65j), the Cumberland Mountains (69d), the Sequatchie Valley (68b) and the Mississippi Valley Alluvial Plain (73a). Only two percent of the documented reservoirs in the state have been constructed in these four regions. Although ecoregion guidelines may be useful, there may need to be additional groupings based on type of reservoir. It is also possible that an emphasis on downstream impacts, especially in the smaller impoundments, will prove more appropriate,

Two of these reservoirs, have been selected for monitoring as part of the National Lake's Assessment. They are Lake Woodhaven in Montgomery Bell State Park (Ecoregion 71f) and Burgess Falls Lake in Burgess Falls State Park (Ecoregion 71g). The data from Lake Woodhaven may be useful for evaluating background levels, but the Burgess Falls Lake is heavily silted in.

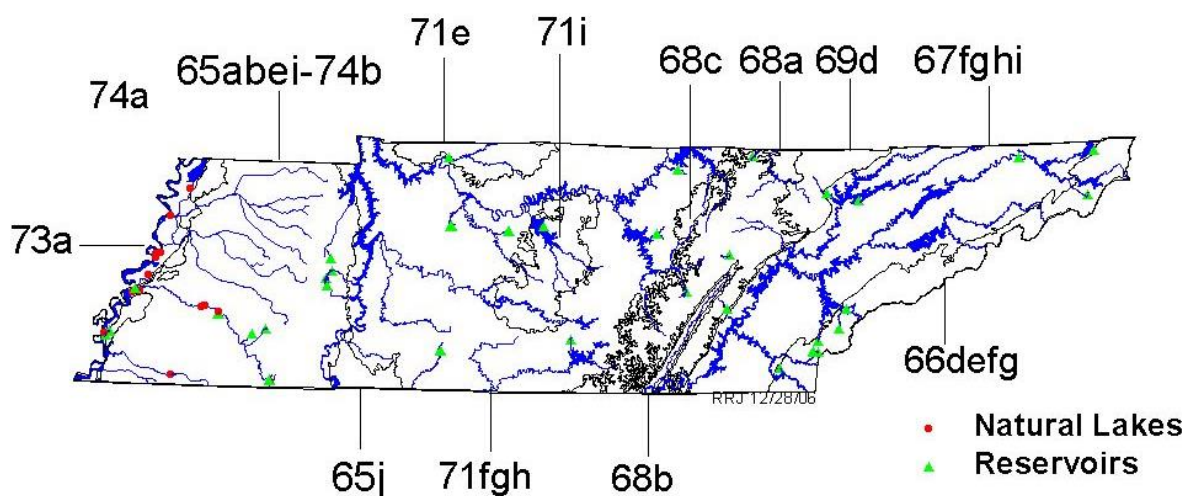

Figure 11: Location of small lakes and reservoirs located on protected lands in Tennessee

If additional federal funding is available, these impoundments as well as downstream reaches will be monitored for three years to establish nutrient levels that support designated uses. Additional impoundments will be selected based on review of existing biological data of downstream reaches and field reconnaissance for any large ecoregions where suitable impoundments were not located during the probabilistic study. Selection of suitable impoundments for nutrient criteria development will be based primarily on downstream biotic assemblages. Ideally, three to five impoundments will be targeted in each bioregion (15). Impoundment monitoring will include, at minimum, nutrients, turbidity, Secchi measurements, macroinvertebrates, chlorophyll, temperature and dissolved oxygen. The same parameters will be measured downstream of the impoundment. The large reservoir work-group will be asked to review the small to medium impoundment strategy as it is developed.

In 1991, the Division conducted a survey of forty selected lakes and reservoirs throughout the state as part of the Clean Lakes Program (Hansel et al, 1992). This was a continuation of a survey conducted in 1980. Thirty-three of the sites were impoundments less than 250 acres. The Carlson Index was used to determine trophic status. Sixty one percent of the small impoundments were either eutrophic or hypereutrophic. Of these, only two showed improvement from an earlier survey conducted in 1980. Five years later a survey was conducted on 13 TWRA and two municipal managed lakes (Arnwine, 1996). All but one of the lakes in the 1996 study were either eutrophic or hypereutrophic.

Although they are small, these reservoirs are often in headwater areas and have the potential to affect downstream reaches. As part of a 104(b)(3) probabilistic study, Tennessee monitored the downstream reaches of 75 small reservoirs across the state. The report was published in September 2006 (Arnwine et al). Only four of the streams passed biological criteria downstream of the reservoirs. Eighty-four percent had elevated levels of total phosphorus and/or nitrate+nitrite in at least one season sampled (Figures 12 and 13).

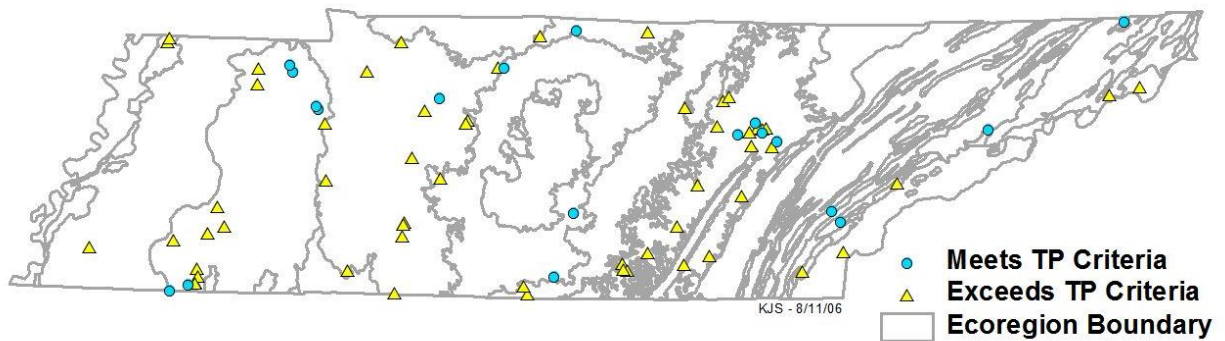

Figure 12: Location of impounded test sites with total phosphorus concentrations above regional guidelines.

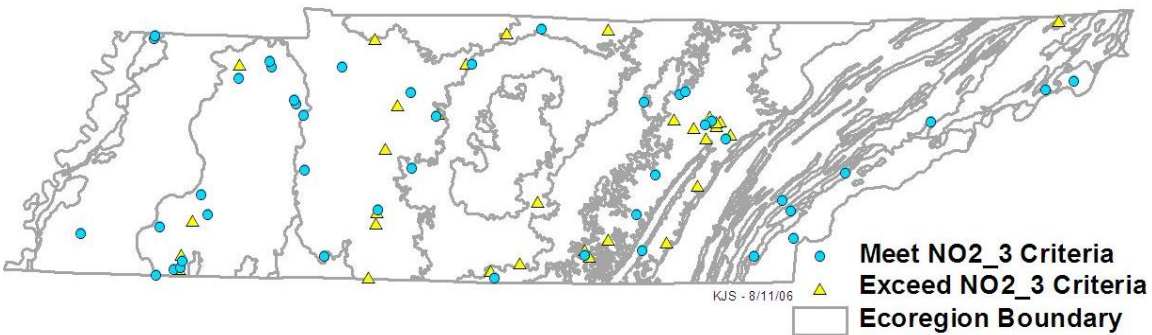

Figure 13: Location of impounded test sites with nitrate+nitrite concentrations above regional guidelines for one or more seasons.

Wetlands

Like reservoirs, wetlands are covered under the emergency nutrient rule in 2003 and were promulgated in the 2004 Water Quality Standards. At this time, the division is uncertain what approach might be best for nutrient criteria development for wetlands. It may be possible to select reference quality wetlands based on wetland functions. Due to lack of state funding, federal assistance will be needed to implement wetland criteria development.

VI. PUBLIC PARTICIPATION AND PEER REVIEW PROCESS

In general, public participation for nutrient criteria development is conducted as part of TDEC's rule revision/adoption process. This involves public notices, public hearings and receiving comments from the public regarding the proposed changes to the rules.

All findings are published and made available to the public through the department's web site, mailings and various public meetings. Additionally, many of our publications are housed at the 13 state document repositories. These repositories include the state library and archives, state university, and public libraries.

When funding for travel is available, TDEC staff present findings and papers to professional organizations. In the past, presentations have been given at meetings such as the Region 4 Regional Technical Advisory Group (RTAG), the TNAWRA (Tennessee Section of the American Water Resources Association), SWPBA (Southeastern Water Pollution Biologists Association) and SFS (Society for Freshwater Science). TDEC has dedicated time and staff to actively participate as a state member of the EPA Region 4 Regional Technical Advisory Workgroup (RTAG).

VII. TIMELINE (Based on Calendar Year)

This timeline outlines the steps TDEC has taken since 1995 as well as future goals in nutrient criteria development. The plan is resource intensive and represents only a small portion of staff responsibilities. This plan is dependent on availability of additional federal resources being provided to the state. Due to budget constraints, changes in priorities, or personnel availability, plans may not progress on schedule.

This timeframe presents the ideal process and is dependent on additional federal funding. Obviously, future activities are subject to revision.

1995

Initiation of ecoregion delineation and reference stream targeting.

Initial field reconnaissance of potential reference streams.

1996

Intensive reference stream monitoring.

Monitoring of 15 moderate size lakes as part of the clean lakes program.

1997

Intensive reference stream monitoring.

1998

Intensive reference stream monitoring.

1999

Intensive annual reference stream monitoring ends. (Monitoring continues in conjunction with the 5-year watershed cycle.)

TDEC staff members Denton and Wang participate in national workgroup for development of nutrient criteria for rivers and streams.

2000

Publication of *Tennessee Ecoregion Project* (Arnwine et al, 2001).

Data reduction for regional nutrient criteria development of wadeable streams and rivers.

Data reduction of macroinvertebrate data for development of regional biological criteria

Publication of EPA national nutrient criteria document for rivers and streams. Document contains a case study from Tennessee.

2001

Probabilistic study of 50 streams in the Inner Nashville Basin initiated.

Publication of *Development of Regionally-Based Interpretations of Tennessee's Narrative Nutrient Criterion* (Denton et al, 2001).

Publication of *Development of Regionally-based Numeric Interpretations of Tennessee's Narrative Biological Integrity Criterion* (Arnwine and Denton, 2001).

Staff proposal for initiation of triennial review process. Promulgation of numeric nutrient and biological integrity criteria recommended.

2002

Continuation of probabilistic study with added emphasis on nutrient and macroinvertebrate relationships.

Continuation of triennial review process for nutrient and biological criteria.

2003

Rulemaking process is initiated for water quality criteria revisions.

Emergency narrative nutrient criteria is promulgated by the Board, and then approved by EPA.

Based on EPA and public concerns, nutrient criteria and biological integrity proposal is changed from numeric to narrative with numeric guidelines referenced.

Promulgated rulemaking hearing rules, including narrative nutrient criteria for protection of fish and aquatic life and recreation in all types of waterbodies is submitted to EPA for approval.

Publication of *Probabilistic Monitoring in the Inner Nashville Basin with Emphasis on Nutrient and Macroinvertebrate Relationships* (Arnwine et al, 2003).

Publication of *Nutrient Levels, Periphyton Densities and Diurnal Dissolved Oxygen Patterns in Impaired and Reference Quality Streams in Tennessee* (Arnwine and Sparks, 2003).

Initiation of probabilistic monitoring of 75 streams below small impoundments.

2004

New water quality standards, including narrative nutrient criteria referencing regional guidelines and revised biological criteria, become a state regulation.

Nutrient criteria development plan drafted and submitted to EPA for comments.

EPA approves water quality standards including narrative nutrient criteria for all waterbodies with regional guidelines for wadeable streams as well as the biological criteria, which are referenced in nutrient criteria. EPA takes no formal action on the proposed flow basis for application of nutrient criteria.

Initiation of new diurnal dissolved oxygen, periphyton, and nutrient study. New project includes study of non-wadeable streams in two ecoregions.

Completion of monitoring for probabilistic study of streams below small impoundments.

Revised nutrient criteria document resubmitted to EPA and approved.

2005

Retrieval and compilation of existing data for large reservoirs and non-wadeable rivers. Obtained existing data from TVA and USACE. Identified data gaps.

Chemical and physical data evaluation on probabilistic monitoring below small impoundments.

Published report on Regional Characterization of Streams in Tennessee with Emphasis on Diurnal Dissolved Oxygen, Nutrients, Habitat, Geomorphology and Macroinvertebrates (Arnwine et al, 2005). Used dissolved oxygen study to help characterize background nutrient levels and target reference reaches in non-wadeable streams in west Tennessee.

Division staff participated in EPA periphyton Workshop in Region 4.

Division staff participated in large river monitoring workshop at Southeast Water Pollution Biologists Association meeting in Mississippi.

2006

Biological data evaluation on probabilistic monitoring below small impoundments and publication of report characterizing the effects of small impoundments on nutrient levels, biota, and other factors (Arnwine et al, 2006).

Promulgated nutrient response criterion for Pickwick Reservoir based on Alabama criterion. Pickwick Reservoir: those waters impounded by Pickwick Dam on the Tennessee River. The reservoir has a surface area of 43,100 acres at full pool, 9,400 acres of which are within Tennessee. Chlorophyll *a* (corrected, as described in *Standard Methods for the Examination of Water and Wastewater, 20th Edition, 1998*): the mean of the photic-zone, composite chlorophyll *a* samples collected monthly April through September shall not exceed 18 µg/l, as measured over the deepest point, main river channel, dam forebay.

Division staff participated in planning phase of National Probabilistic Monitoring of Lakes and Reservoirs Study. Attended planning meeting, numerous conference calls and reviewed study plans. Staff conducted reconnaissance of 24 reservoirs to determine suitability for study.

Division staff participated in regional study sponsored by EPA to study in-stream nutrient and biological response in the Southeastern Plains (ecoregion 65). Field staff monitored nutrients and periphyton at ten survey sites along a disturbance gradient.

Identified small lakes and reservoirs on protected lands as potential sources of baseline data to develop nutrient criteria on small lakes and reservoirs.

Added percent nutrient tolerant organisms to multi-metric macroinvertebrate index for wadeable streams to increase sensitivity of index to nutrient and sediment impacts.

2007

Compiled data from large and medium reservoirs.

Participated in national probabilistic lake monitoring study by sampling 12 lakes.

Looked, without success, for funding sources for monitoring of small lakes and reservoirs on public lands to establish baseline.

Participated in planning stage of probabilistic study of the Nation's Large Rivers. Participated in biocriteria and reference condition workgroups.

Compiled existing non-wadeable stream and river data. Reviewed existing data to determine additional monitoring needs on large rivers.

Began monitoring of periphyton in reference streams and probabilistic monitoring streams for potential development of wadeable stream index.

Submitted a revised Nutrient Criteria Development Plan to EPA.

2008

Began a headwater reference stream project to identify a minimum of 77 headwater (<2.6 square miles) reference streams in 13 bioregions and monitor for nutrients macroinvertebrates and periphyton to develop appropriate biological response indices.

Reviewed findings of EPA National Lake and Reservoir Survey for guidance in establishing reference condition in TN reservoirs. Results were considered insufficient due to lack of differentiation between natural lakes and reservoirs in the study.

Reviewed available reservoir data from multiple sources (TVA, USACE, TDEC) to consider possible options for criteria development in managed systems. Due to nature of managed systems, it is not feasible to develop reference condition applicable to multiple reservoirs. As resources permit, TDEC will consider other options.

Reviewed EPA criteria development guidance for wetlands. Unable to implement due to lack of funding/staff time.

Due to lack of resources and inadequate guidance on reference condition, projected monitoring of reference reservoir and non-wadeable rivers was not implemented.

2009

Incorporated periphyton monitoring at established wadeable reference streams (> .25 sq mile drainage) to develop a second indicator species sensitive to nutrient impairment.

Incorporated periphyton monitoring at select nutrient impaired sites to establish a disturbance gradient for calibration of periphyton index.

Continued monitoring candidate headwater reference streams.

2010

Continued monitoring candidate headwater reference streams.

Continued periphyton monitoring in all reference streams.

2011

Continued monitoring candidate headwater reference streams.

Continued periphyton monitoring in all reference streams.

Incorporated preliminary headwater macroinvertebrate guidelines in QSSOP for assessment purposes.

2012

Continued monitoring candidate headwater reference streams.

Continued periphyton monitoring in all reference streams.

Participated in non-wadeable stream workshop at Southeastern Water Pollution Biologists Association (SWPBA) meeting in Alabama. Compared protocols used by other Region IV states and discussed advantages/disadvantages.

Convened workgroup at Division annual meeting to evaluate non-wadeable stream protocols. Preliminary protocols were agreed upon but lack of staff availability prohibits sampling.

2013

Continue monitoring of candidate headwater reference streams.

Continue periphyton monitoring in all reference streams.

2014

Completed candidate headwater reference stream monitoring. Began testing and finalization of reference sites. Metric selection and calibration deferred to 2015 upon finalization of reference selection.

2015

Testing and finalization of headwater reference sites. Began calibration of a multi-metric index using metrics sensitive to macroinvertebrate community in headwater streams and calibrated by ecoregion.

2016

Continue calibration of headwater stream biometrics.

2017

Macroinvertebrate index was developed for headwater streams. Calibrated guidelines were published in the 2017 Quality System Standard Operating Procedure and incorporated into assessments. The index includes metrics sensitive to nutrient impairment.

Collaborated with Alabama, Kentucky and Georgia to draft a N-Steps grant proposal for development of a diatom index.

Began review of reservoir criteria implemented by other Region 4 states. (Aborted due to lack of staff availability).

2018

Continued collaboration with Alabama, Kentucky and Georgia to revise N-Steps grant based on EPA recommendations for development of a diatom index. The grant request was initiated in 2017.

2019

Harmonize diatom data to USGS biodata taxonomy in agreement with AL, KY and GA.

Collaborate with other region IV states to submit diatom data to Tetrtech to test harmonization and regionalization and begin preliminary analysis for metric development.

Participate in a workgroup with AL, GA, KY, Tetrtech and EPA to continue progress toward development of SE regional diatom index.

Convene a nutrient criteria workgroup to review nutrient criteria workplan and submit to EPA.

Incorporate diatom sampling in 106 monitoring workplan at group 4 sites suspected of nutrient impairment.

2020

In conjunction with the southeast workgroup, complete calibration and testing of SE diatom index. Revise periphyton QSSOP to incorporate index. Continue to include diatom monitoring in conjunction with watershed assessment cycle.

Explore feasibility of using chlorophyll criterion established for Pickwick Reservoir for other main-stem lower Tennessee Reservoirs.

Investigate applicability of using existing TVA and USACE chlorophyll data to develop chlorophyll criteria for upper main-stem Tennessee, Cumberland and tributary reservoirs based on methods used by Alabama for Pickwick.

Consider possibility of using chlorophyll or other measures of reservoir eutrophication as a trigger point to implement nutrient reduction strategy.

Evaluate continuous monitoring techniques developed in Pennsylvania for assessing eutrophication of reservoirs for potential use in Tennessee.

Review results from Greater Nashville Council Grant (contracted to USGS) including compilation of raw data and proposed classification of lakes and reservoir in Cumberland and Tennessee River Basins larger than 25 acres into five groups based on chlorophyll a, nitrogen, total phosphorus and Secchi disk based on predictive models. Evaluate whether data compilation and/or classification scheme can be helpful in reservoir criteria development.

2021

Continue exploration of chlorophyll based criteria on large reservoirs.
Continue exploration of continuous monitoring techniques on large reservoirs.

Apply diatom index to Group 4 watershed assessments. Consider incorporating diatom index by reference in WQS as nutrient response.

2022

Revisit non-wadeable macroinvertebrate sample methods used in other states and EPA national study. Consider feasibility for use in TN. Identify potential reference reaches.

Investigate options for development of chlorophyll or other nutrient response criteria on smaller reservoirs and lakes.

2023

Depending on staff availability or federal assistance incorporate nonwadeable monitoring at select sites within Group 3 watersheds (reference and disturbed).

Dependent on federal funding for contracts begin monitoring of medium size reservoir chlorophyll and nutrients.

2024

Depending on staff availability or federal assistance incorporate nonwadeable monitoring at select sites within Group 4 watersheds (reference and disturbed).

Dependent on federal funding for contracts continue monitoring of medium size reservoir chlorophyll and nutrients.

2025

Depending on staff availability or federal assistance incorporate nonwadeable monitoring at select sites within Group 5 watersheds (reference and disturbed).

Dependent on federal funding for contracts continue monitoring of medium size reservoir chlorophyll and nutrients.

2026

Depending on staff availability or federal assistance incorporate nonwadeable monitoring at select sites within Group 1 watersheds (reference and disturbed).

Dependent on federal funding for contracts continue monitoring of medium size reservoir chlorophyll and nutrients.

2027

Depending on staff availability or federal assistance incorporate nonwadeable monitoring at select sites within Group 2 watersheds (reference and disturbed).

Dependent on federal funding for contracts continue monitoring of medium size reservoir chlorophyll and nutrients.

2028

Compile nonwadeable river data and explore possibility of developing macroinvertebrate and diatom indices.

If federal funding was available for monitoring, compile smaller reservoir data. Consider feasibility of developing chlorophyll criteria or continue monitoring (if funded) in 2029.

Note: Small Reservoirs and Wetlands will be addressed when other waterbody types are complete.

VIII. NEEDS ASSESSMENT FOR TENNESSEE'S NUTRIENT CRITERIA DEVELOPMENT PROGRAM

Tennessee has traditionally had a strong water quality monitoring, assessment and criteria development program. In the last 20 years, water quality monitoring chemical and bacteriological monitoring has increased six fold and biological monitoring has more than doubled. . New procedures such as continuous monitoring, diatom surveys and probabilistic monitoring have been used to supplement targeted biological and water quality monitoring.

Despite the increase in water quality activities, there has not been an increase in monitoring staff during this period. The increased ability to conduct monitoring, assessments and criteria development without a net increase in the number of positions has been a result of standardization of methods, replacing intensive surveys with rapid field techniques, improvements in electronic data transfer, advances in technology and shifting priorities from other programs.

106 grant project activities in Tennessee are funded by state appropriations and EPA grant dollars. An estimated 2 million dollars are obligated for employee salaries, benefits, equipment, travel and other expenses. An additional \$1.5 million is spent on laboratory analysis.

As always, the division is interested in improving its water quality assessment program and serving the public by protecting the waters of Tennessee. It is evident that Tennessee already spends a great deal of time, effort and money on water quality monitoring. However, a significant funding gap does exist if EPA requirements and guidance for nutrient criteria development are to be met. Without a steady source of federal funding **in addition** to current funding, it is not likely that the monitoring needed for nutrient criteria development and assessment for non-wadeable rivers, reservoirs or lakes will be feasible.

Additional staffing and funding must be permanent and not in the form of competitive or temporary grants to expand programs. TDEC is not expecting additional funding from other sources for these activities over the next ten years. As mentioned previously, it does not appear that TVA will be able to provide as much monitoring support as anticipated due to an agency moratorium on additional monitoring. Therefore, federal funding increases would be vital for implementation of all or part of the nutrient criteria goals. The following outlines the staff,

equipment and additional federal funding that would be necessary to implement a criteria development, monitoring and assessment plan for rivers and reservoirs.

Personnel costs are based on average year expenses per full-time employee and include salary, benefits, travel, printing, maintenance, professional services, supplies, rent and insurance, vehicle operation, equipment and services. The cost of a full time technical employee including benefits is approximately \$90,000 annually with indirect costs \$21,700.

The estimated costs would include a full reservoir and large river water quality program including criteria development, monitoring in support of criteria development as well as 305(b) and 303(d) assessments, TMDLs and data management. Activities would continue to be coordinated with other agencies performing reservoir and river monitoring to share resources and to prevent duplication of efforts.

**Additional Annual Federal Funding needed: \$ 1,501,900
Plus \$300,000 one-time purchase for equipment to start program.**

Additional Field Staff needed: Six field biologists dedicated to monitoring reservoirs and large rivers Staff would be used to increase percentage of watershed assessments for 305(b) reports after nutrient criteria development.

Additional Central Office Staff: One biologist in Watershed Planning Unit (criteria development, monitoring coordination, data processing, data management, mapping, water quality assessments)

Laboratory analysis = \$720,000 per year (with approx. 5% annual increase)

Equipment Needs = \$300,000 (one-time costs)

3 large boats and 3 canoes/jon boats (to be shared by field offices in each of the 3 main regions of the state, 3 multiparameter probes with 25 meter cable for temperature/DO profiles, 3 field filter apparatus for chlorophyll samples, Fluorimeter for chlorophyll analysis to be used by central laboratory, block digester and flow injection analyzer for nutrient analysis

In addition to staffing needs, Tennessee would also like assistance in developing a monitoring design and statistical interpretation of results specifically for reservoirs and large rivers.

VIX. REFERENCES

- Arnwine, D.H. 1996. *Evaluation of Thirteen TWRA and Two Municipal Managed Lakes in Thirteen Counties (Seven Ecological Subregions) of Tennessee, August-September, 1996*. 1996. Tennessee Department of Health, Environmental Laboratories, Nashville, TN.
- Arnwine, D.H., J.I. Broach, L.K. Cartwright and G.M. Denton. 2000. *Tennessee Ecoregion Project*. Tennessee Department of Environment and Conservation, Division of Water Pollution Control, Nashville, TN.
- Arnwine, D.H. and G.M. Denton. 2001. *Development of Regionally-based Interpretations of Tennessee's Existing Biological Integrity Criterion*. Tennessee Department of Environment and Conservation, Division of Water Pollution Control, Nashville, TN.
- Arnwine, D.H., K.J. Sparks and G.M. Denton. 2003. *Probabilistic Monitoring in the Inner Nashville Basin with Emphasis on Nutrient and Macroinvertebrate Relationships*. Tennessee Department of Environment and Conservation, Division of Water Pollution Control, Nashville, TN.
- Arnwine, D.H. and K.J. Sparks. 2003. *Comparison of Nutrient Levels, Periphyton Densities and Diurnal Dissolved Oxygen Patterns in Impaired and Reference Quality Streams in Tennessee*, Tennessee Department of Environment and Conservation, Division of Water Pollution Control, Nashville, TN.
- Arnwine, D.H., R.J. James and K.J. Sparks. 2005. *Regional Characterization of Streams in Tennessee with Emphasis on Diurnal Dissolved Oxygen, Nutrients, Habitat, Geomorphology and Macroinvertebrates*. Tennessee Department of Environment and Conservation, Division of Water Pollution Control, Nashville, TN.
- Arnwine, D.H., K.J. Sparks and R.R. James. 2006. *Probabilistic Monitoring of Streams Below Small Impoundments in Tennessee*. Tennessee Department of Environment and Conservation, Division of Water Pollution Control, Nashville, TN.
- Brumley, J.F., G.J. Pond and M.C. Compton. 2003. *Determining Nutrient Impairment Using Biological and Other Non-Chemical Indicators in Kentucky Streams*. Kentucky Division of Waters, Ecological Support Section.
- Denton, G.M. 1987. *Water Quality at Reelfoot Lake 1976-1986*. Tennessee Department of Health and Environment, Division of Water Management, Nashville, TN.
- Denton, G.M., D.H. Arnwine and S.H. Wang. 2001. *Development of Regionally-Based Interpretations of Tennessee's Narrative Nutrient Criterion*. Tennessee Department of Environment and Conservation, Division of Water Pollution Control, Nashville, TN.
- Denton, G.M., K.J. Sparks, D.H. Arnwine and L.K. Cartwright. 2002. *The Status of Water Quality in Tennessee: Year 2002 305(b) Report*. Tennessee Department of Environment and Conservation, Division of Water Pollution Control, Nashville, TN.

Dycus, D.L. and T.F. Baker. 2001. *Aquatic Ecological Health Determinations for TVA Reservoirs –2000*. Tennessee Valley Authority, Resource Stewardship, Chattanooga, TN

Griffith, G.E., J.M. Omernik and S.H. Axenedo. 1997. *Ecoregions of Tennessee*. EPA/600-R-97-022. U.S. EPA, National Health and Environmental Effects Research Laboratory, Corvallis, OR.

Hansel, J.A., M.C. Flexner and G.M. Denton. 1992. *Survey of Forty Selected Lakes and Reservoirs in Tennessee, May Through December, 1991*. Tennessee Department of Environment and Conservation, Division of Water Pollution Control, Nashville, TN.

Tennessee Department of Environment and Conservation. 2013. *Rules of the Tennessee Department of Environment and Conservation, Division of Water Resources, Chapter 0400-40-03, General Water Quality Criteria*, Division of Water Resources, Nashville, TN.

_____. 2017. *Quality System Standard Operating Procedure for Macroinvertebrate Stream Surveys*, Tennessee Division of Water Resources, Nashville, TN.

Tennessee Department of Health and Environment. 1984. *A Clean Lakes Study: The Upper Buck Basin of Reelfoot Lake*, Tennessee, Division of Water Management, Nashville, TN.

U.S. Environmental Protection Agency. 2002. *Ambient Water Quality Recommendations, Lakes and Reservoirs in Nutrient Ecoregion X*. EPA/822-B-00-011. U.S. EPA, Office of Water, Washington D.C.

_____. 2000. *Ambient Water Quality Recommendations, Lakes and Reservoirs in Nutrient Ecoregion IX*. EPA/822-B-00-011. U.S. EPA, Office of Water, Washington D.C.

_____. 2000. *Ambient Water Quality Recommendations, Lakes and Reservoirs in Nutrient Ecoregion XI*. EPA/822-B-00-011. U.S. EPA, Office of Water, Washington D.C.

_____. 2000. *Nutrient Criteria Technical Guidance Manual: Rivers and Streams*. EPA/822-B-00-002. U.S. EPA, Office of Water. Washington D.C.

_____. 1998. *National Strategy for the Development of Regional Nutrient Criteria*. EPA/822-R-98-002. U.S. EPA, Office of Water. Washington D.C.

APPENDIX A

**Division of Water Pollution Control Responses to EPA Comments on Initial 2004 Nutrient
Criteria Development Plan**

EPA Comment: Comparison of the state's proposed level IV ecoregion nutrient criteria to the national ecoregional criteria recommendations indicates that the state proposed levels are generally substantially in excess of the national recommendations.

We do not believe that a direct comparison of the state's subregional (Level IV) nutrient data to the national Level III ecoregion data is appropriate. Many of the data from the Level IV subregions are statistically different from the larger Level III ecoregion at the state level. The national database contains subregions not even found in Tennessee. Our Level III ecoregions were delineated into subregions in order to provide this more accurate and localized assessment process.

Additionally, EPA's National Database included data from large rivers and non-wadeable streams that cross Level IV ecoregion boundaries. The state reference database was restricted to wadeable streams that had at least 80% of the upstream drainage included within the targeted subregion. Therefore, the state data are much more refined and indicative of local conditions and stream size. Tennessee plans to develop separate guidelines for large rivers and non-wadeable streams that are more pertinent to these systems.

Tennessee's regional nutrient guidelines for wadeable streams are based on nine years' data (1995-2003), roughly the same spread of years as EPA's national study. Tennessee's use of reference streams at the level IV (ecological subregion) follows EPA's recommendation that State's develop localized criteria whenever possible.

EPA Comment: In the Sequatchie Valley (68b) the nitrate +nitrite and TP proposals are higher than the recommendation for the Southwestern Appalachians.

The Sequatchie Valley is a very small and unique area found only in Tennessee and Alabama. It is considerably different than the other areas of the Southwestern Appalachians. In fact, the Sequatchie Valley is sometimes considered part of ecoregion 67, the Ridge and Valley (Griffith, 1997).

Both TP and NO₂+NO₃ levels data in 68b were significantly different from subregions 68a and 68c, the other two areas of the Southwestern Appalachians in Tennessee. It is unlikely that it was well represented in the national database compared to the amount of data from the rest of the Level III ecoregion, which also includes subregions not found in Tennessee.

EPA Comment: In the Southern Igneous Mountains and Ridges (66d) nitrate+nitrate proposal is higher than national recommendation for the Blue Ridge. The subregion has a much larger area in NC.

The proposed total phosphorus criterion in this region was in line with the national recommendations for the Blue Ridge Mountains. The proposed NO₂+NO₃ levels were higher than the national criterion. This is not surprising since this subregion tested significantly different from the other three Blue Ridge subregions in Tennessee for this parameter.

The five ecoregion reference sites in this region are all on protected lands in the Cherokee National Forest or Roan Mountain State Park. Land use is 92-100% forested upstream of the reference sites so it is likely the NO₂+NO₃ levels measured at these sites represent natural background conditions.

EPA Comment: In the Inner Nashville Basin (71i) TP proposal is higher than national recommendation for Interior Plateau.

The Inner Nashville Basin is unique to Tennessee. The total phosphorus levels are not comparable to any of the other regions in Tennessee and should not be compared to the entire Interior Plateau on a national level. This region is naturally high in phosphorus. Tennessee has data from seven reference sites (105 samples) representing four major watersheds in this region so the background phosphorus levels are well documented.

EPA Comment: In the Western Pennyroyal Karst (71e) nitrate+nitrite is higher than the national recommendation for the Interior Plateau. This subregion is mostly in KY

This region only occurs in Kentucky and Tennessee. Background NO₂+NO₃ levels are naturally very high in this region and should not be compared to the rest of the Interior Plateau (Level III). In response to EPA's concerns, Kentucky reference data were compared to Tennessee's data to verify the high levels of nitrates being observed in reference streams (Figure 17). Kentucky data were higher than Tennessee's. We believe that this information supports the proposed criteria levels, since this region occurs in no other states.

71e Ref Sites

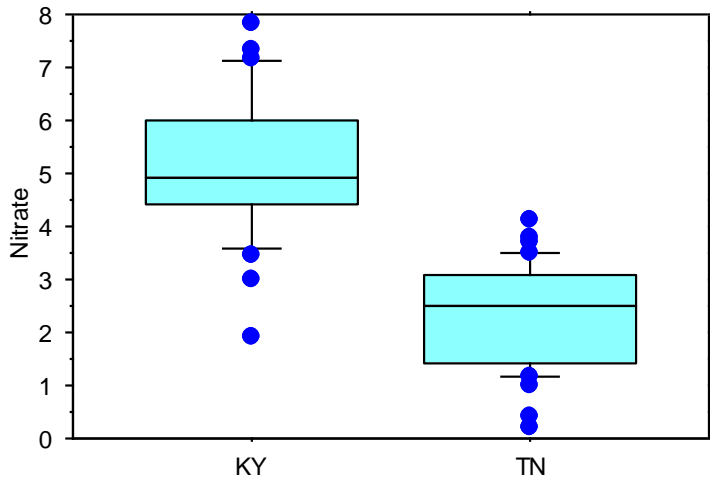

71e Ref

	Nitrate, Total	Nitrate, KY	Nitrate, TN
Mean	3.498	5.146	2.280
Std. Dev.	1.858	1.381	.965
Std. Error	.227	.256	.159
Count	67	29	37
Minimum	.190	1.930	.190
Maximum	7.830	7.830	4.110
# Missing	1	0	1
Median	3.150	4.920	2.520

Results for totals may not agree with results for individual cells because of missing values for split variables.

Percentiles

Split By: State

	Nitrate: Total	Nitrate: KY	Nitrate: TN
10	1.332	3.566	1.176
25	1.935	4.428	1.430
50	3.150	4.920	2.520
75	4.750	5.998	3.087
90	6.102	7.140	3.480

Results for totals may not agree with results for individual cells because of missing values for split variables.

Figure 17: Comparison of nitrate (KY) and nitrate+nitrite (TN) levels at reference streams in Ecoregion 71e. Note: TN is nitrate+nitrite

EPA Comment: In 74b, the Mississippi Valley Loess Plains nitrate+nitrite proposal is higher than national recommendation for Mississippi Valley Loess Plains, considerably larger area in Mississippi.

Nitrate+nitrite levels in this subregion were significantly higher than the only other 74 subregion in Tennessee (74a – Bluff Hills). Therefore the values for Tennessee should only be compared to data in 74b not the entire Level III ecoregion. The national database included larger rivers that crossed ecoregions. In response to EPA’s comments, the NO₂+NO₃ data from 74b reference streams in Tennessee were compared to those in Mississippi where this region is considerably larger (Figure 18). Ranges were comparable with the median levels in Tennessee reference streams being lower indicating the proposed criteria are appropriate.

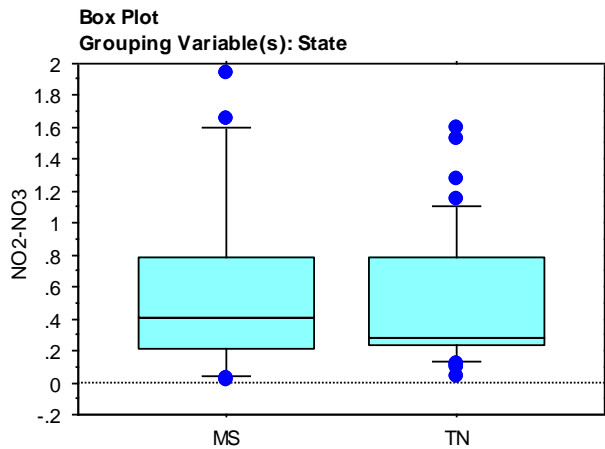

Descriptive Statistics

Split By: State

	Mean	Std. Dev.	Std. Error	Count	Minimum	Maximum	Median
NO ₂ -NO ₃ , Total	.514	.455	.061	55	.020	1.940	.320
NO ₂ -NO ₃ , MS	.579	.555	.139	16	.020	1.940	.405
NO ₂ -NO ₃ , TN	.487	.412	.066	39	.040	1.600	.280

Results for totals may not agree with results for individual cells because of missing values for split variables.

Percentiles

Split By: State

	NO ₂ -NO ₃ : Total	NO ₂ -NO ₃ : MS	NO ₂ -NO ₃ : TN
10	.120	.040	.128
25	.240	.210	.240
50	.320	.405	.280
75	.787	.785	.787
90	1.150	1.596	1.102

Results for totals may not agree with results for individual cells because of missing values for split variables.

Figure 18: Comparison of nitrate+nitrite levels of Mississippi and Tennessee reference streams in the Mississippi Loess Plains

EPA Comment: In 67g, the Southern Shale Valleys, the TP proposal is higher than national recommendation for Ridge and Valley.

Total phosphorus data in the Southern Shale Valley subregion were statistically different from the other three Ridge and Valley subregions in Tennessee. Since the national database is an aggregate of data from all subregions in the Ridge and Valley ecoregion, it should not be directly compared to this distinct subregion.